

SnapScan™ 1212u

USB Version

Owner's Guide

[Preface](#)

This chapter gives you information about SnapScan, about the organization, and about [how to use this guide](#).

[Chapter 1 — Preparing the Scanner](#)

“Preparing the Scanner” explains how to prepare your SnapScan for installation.

[Chapter 2 — Installing the Scanner for PC](#)

This chapter shows you how to set up your SnapScan for your PC.

[Chapter 3 — Installing the Scanner for Macintosh®](#)

This chapter shows you how to set up your SnapScan for your Macintosh.

[Chapter 4 — Making your first scan](#)

Here you find instructions on how to make your first scan.

[Appendix A — Troubleshooting](#)

“Troubleshooting” can be helpful when you come across problems.

[Appendix B — Technical Information on the SnapScan 1212u USB Version](#)

This appendix provides specifications for your SnapScan 1212u USB Version.

[Appendix C — SnapScan Regulation Compliance](#)

This appendix gives you information about safety regulations and electromagnetic compatibility.

Trademarks

AGFA and the Agfa rhombus are trademarks of Agfa-Gevaert AG.

ScanWise and SnapScan are trademarks of Agfa-Gevaert N.V.

Acrobat is a trademark of Adobe Systems Incorporated which may be registered in certain jurisdictions.

Apple, Macintosh, PowerPC and System 8 are trademarks of Apple Computer Inc., registered in the U.S. and other countries.

Caere is a registered trademark of Caere Corporation.

Color It! is a trademark of MicroFrontier, Inc.

Corel is a registered trademark of Corel Corporation.

Pentium is a registered trademark of Intel Corporation.

IBM PC is a trademark of International Business Machines Corporation.

Microsoft, Windows and Windows NT are registered trademarks of Microsoft Corporation in the U.S. and other countries.

Other product or company names are trademarks or registered trademarks of their respective holders.

Copyright © 1999 Agfa-Gevaert N.V.

All rights reserved.

All software and hardware described in this document are subject to change without any notice.

Conventions

The following conventions are used in this guide:

- ❖ Note: a note of this type gives you additional information.
 - Instructions are preceded by a small red square.
1. Numbered steps describe the actions you must take to perform a task.

Contents

Preface	5
About SnapScan	6
Environmental Requirements	6
Precautions.....	7
Cleaning your Scanner	7
How to Use this Guide.....	8
How to Print this Guide	9
Chapter 1 — Preparing the Scanner	10
Unpacking the Scanner	11
Taking a Closer Look.....	11
Unlocking the Scanner	12
Chapter 2 — Installing the Scanner for PC	14
Minimum System Requirements	15
Installing the Scanner Software	16
Connecting the Scanner to your PC	17
Installing Additional Software.....	18
Chapter 3 — Installing the Scanner for Macintosh	19
Minimum System Requirements	20
Installing the Image Editing Software	20
Installing the Scanner Software	20
Connecting the Scanner to the Macintosh Computer.....	21
Installing Additional Software.....	23

Chapter 4 — Making your First Scan	24
Appendix A — Troubleshooting	25
Appendix B — Technical Information	28
Appendix C — Regulation Compliance	29
Safety Regulations	30
UL Safety Statement	30
TÜV: Wichtige Sicherheitshinweise	30
Electromagnetic Compatibility	31
Federal Communications Commission Radio Frequency Interference Statement	31
Industry Canada Class A and B Label Requirements	31

Preface

[About SnapScan](#)

[Environmental Requirements](#)

[Precautions](#)

[Cleaning your Scanner](#)

[How to Use this Guide](#)

[How to Print this Guide](#)

About SnapScan

In this Owner's Guide, the name SnapScan is used for the SnapScan 1212u.

The SnapScan is a one pass flatbed color scanner with a resolution of 600 x 1200 ppi equipped with a cold cathode lamp. It is based on CCD (Charge Coupled Device) scanning technology. With the SnapScan, you can scan line-art, gray-scale and color reflective originals up to A4 format.

The scanned data is transferred through the computer's USB (Universal Serial Bus) port. The USB technology makes it easy to install multiple peripherals to your computer. USB eliminates any need to turn off or restart the computer when attaching a new peripheral.

SnapScan is a scanner that captures and converts reflective originals (for example pictures, text) into electronic data that can be used in computer applications. It offers high-resolution image capturing and is an ideal tool in making presentations come to life.

SnapScan supports multiple scanning modes and includes scanner software to get you started right away. With its powerful and easy-to-use scanner driver software, SnapScan gives you easy access to high-quality color scans. The scanner driver software gives you a number of additional features to create special effects or to reproduce even the most difficult originals.

The document cover is adjustable: when you put a thick original (like a book or a magazine) on the reflective glass plate, the document cover adapts to the thickness of the original.

Environmental Requirements

- Place the scanner on a horizontal, flat surface.
- To ensure proper ventilation, allow a minimum of 10 cm (4 inches) free space around each side of the scanner.
- Make sure that no vibrations or shocks occur.
- Make sure that the area is free of dust.
- Avoid any contact with water. Do not use your scanner near water or in a damp environment.
- Your SnapScan is designed to perform at best when the environmental humidity is between 20% and 85%. Avoid environments where humidity fluctuations might occur.
- Your SnapScan is designed to perform at best when the environmental temperature is between 10 °C and 40 °C. Avoid exposure to direct sunlight and heating devices.

- Check whether the voltage of the AC adapter corresponds to the voltage in your area. If it does not correspond, contact your dealer. Avoid environments where voltage fluctuations might occur.

Precautions

For your own safety and that of your equipment, respect conscientiously the [Environmental Requirements](#) and always take the following precautions:





- Check frequently whether there is no overheating of the AC adapter.
- If you do not use your scanner for some time, pull the AC adapter out of the power supply socket.
- Handle your SnapScan with care: the glass plate is fragile. There is no warranty on breaking the glass plate and your dealer is not liable for consequential damages.
- Disconnect the AC adapter when you want to clean the scanner housing or the glass plate and when the scanner needs servicing or repairing.
- Do not open the scanner housing as it contains high-voltage areas and sensitive components. Every repair should be carried out by your dealer.
- Do not leave originals on the reflective glass plate for excessive periods of time. The warmth of the scanner may cause them to deteriorate.
- For safety reasons, never use extension cables for the AC adapter.

Caution: For safety reasons, besides the personal maintenance mentioned in this Owner's Guide, do not try to remove any mechanical parts or any electronic components from your scanner. If your scanner needs service, our dealer and service offices are available to help you.

Cleaning your Scanner

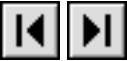
- Cleaning the glass plate regularly, ensures that dirt or smudges do not reduce the quality of your scanned images.
- Before cleaning, disconnect the AC adapter from your scanner.
- Use a soft damp cloth and a mild detergent to clean the surface of the glass plate. If you use alcohol to clean the glass plate, make sure that you do not touch the plastic elements of the scanner.
- Avoid using sprays directly onto the glass plate as this may cause the liquid to penetrate the seams around the glass and contaminate the mirrors and lenses inside the scanner.
- Do not use liquid cleaners or aerosol cleaners.

How to Use this Guide

<p>About SnapScan</p> <p>Environmental Requirements</p> <p>Precautions</p>	<p>Click any text or graphic that is identified as hypertext link. The arrow pointer changes into an index finger when positioned over a link.</p> <p>Underlined text is “linked” to another part of this guide.</p>
<ul style="list-style-type: none"> ▷ □ Preparing the Scanner ▷ □ Installing the Scanner for PC ▽ □ Installing the Scanner for Macintosh <ul style="list-style-type: none"> □ Minimum System Requirements 	<p>Click on the bookmark name to go to the topic marked by that bookmark. Click the triangle to the left of a bookmark to show and hide subordinate bookmarks.</p>
	<p>Use the First Page or Last Page button to move the document to the first or last page of this manual.</p>
	<p>Use the Go Back and Go Forward buttons to retrace your steps in this guide, moving to each view in the order visited.</p>
	<p>Use the Previous Page or Next Page button to move the document backward or forward, one page at a time. You can also use the keyboard arrows.</p>
	<p>Use the zoom tool to magnify and reduce (Control-click) the page display.</p>
	<p>Click the Find button to search for part of a word, a complete word, or multiple words in this document. You can also consult the supplied index.</p>
<p>Print</p>	<p>Choose Print from the File menu to print this online guide.</p>

How to Print this Guide

1. Choose Page Setup from the File menu.
2. Choose your paper format from the Paper popup menu.
3. Select Orientation: Portrait.
4. Click OK.
5. Choose Print from the File menu.

Chapter 1 — Preparing the Scanner



This chapter helps you to prepare your SnapScan for installation.

[Unpacking the Scanner](#)

[Taking a Closer Look](#)

[Unlocking the Scanner](#)

Unpacking the Scanner

1. Open the packing box and carefully take out all the items.
2. Check each item to make sure that you have everything listed on the box and on the Packing List. Check if there is no visible defect.
If something is missing, contact your dealer.
3. Remove the plastic wrapping and the packing materials from the scanner.
 - ❖ Note: Save the packing materials to protect the scanner during later transport.

Taking a Closer Look

Now that you have the scanner out of the box, take a closer look so that you become familiar with its parts. The figures illustrate the locations of the different parts of your SnapScan.



1. glass plate
2. adjustable document cover
3. rulers
4. sleep button
5. status indicator

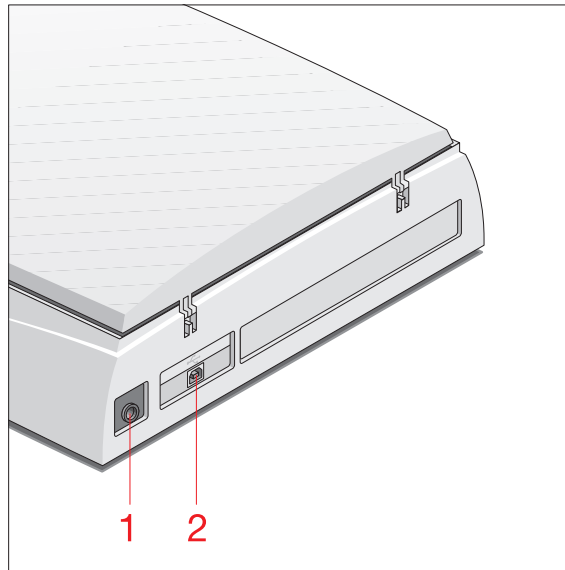

1. AC adapter connector.
2. USB port (labeled with the USB icon ) for connection to your computer.

Unlocking the Scanner

The scanner's optical box contains all optical components and rides back and forth during the scan. A locking slider holds it in place during shipment. Before you switch on the scanner, you first have to unlock it.

1. Place the scanner on a horizontal, flat surface and pull it carefully towards you until you can see the locking slider at the bottom.
2. Slide the locking slider to the right.
Your scanner is unlocked.

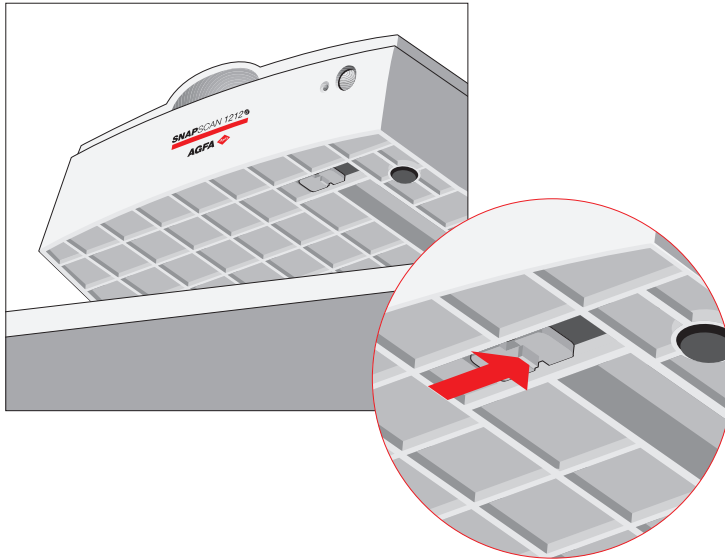

- ❖ Note: If you want to transport your scanner, you have to lock it. To do this, first connect the AC adapter to the scanner so that its optical assembly moves to its home position. When the status indicator stops blinking, slide the locking slider to the left and disconnect the scanner. Your scanner is now locked and ready for transportation.

Caution: Make sure to install the ScanWise software before connecting the scanner to your PC/Mac.

Chapter 2 — Installing the Scanner for PC



This chapter shows you how to set up your SnapScan for your PC.

[Minimum System Requirements](#)

[Installing the Scanner Software](#)

[Connecting the Scanner to your PC](#)

[Installing Additional Software](#)

Minimum System Requirements

- A USB port
- A Pentium® processor
- A 14 inch color monitor
- A 16-bit video card for an accurate display of color images. (minimum 256 colors / High Color (16bit) is recommended)
- 32 MB of RAM (64 MB of RAM is recommended)
- A CD-ROM drive
- Windows® 98
- ScanWise is compatible with all IBM™ PCs and compatibles running Windows 98.
- The amount of disk space available on your PC determines the number and the size of the images that you can scan. Make sure that you have enough free storage space on your hard disk. You need about two times the size of the image to scan, edit and save it.

Installing the Scanner Software

1. Insert the Agfa ScanWise CD-ROM in your CD-ROM drive.
 - ❖ Note: If the ScanWise Installer program does not appear automatically, use the Windows Explorer to start the installation program.
2. Click the up or down arrow to select your language.



This selection determines the language of the ScanWise software and documentation.

3. Click the up or down arrow to select your type of scanner (if needed).



4. Click the dotted right arrow or move the slider to "about ScanWise".



A demonstration of ScanWise will start.

5. Click the dotted right arrow or move the slider to "Install".
 6. Click Acrobat Reader to start the installation.
You need Acrobat Reader to read the documentation.
 7. Follow the instructions on your screen.
When the installation is finished, the Install screen appears again.
 8. Click ScanWise to start the installation.
 9. Follow the instructions on your screen.
- When the installation is finished you are ready to connect your scanner to your PC.

- ❖ Note: For the latest information, refer to the ScanWise Read Me File.

Connecting the Scanner to your PC

- ❖ Note: Make sure the scanner is unlocked before connecting it to the electric outlet.
- 1. Connect the plug of the AC adapter to your scanner (Figure 1).
- 2. Plug the adapter in the wall socket.
- ❖ Note: Check if it complies with your own power supply.

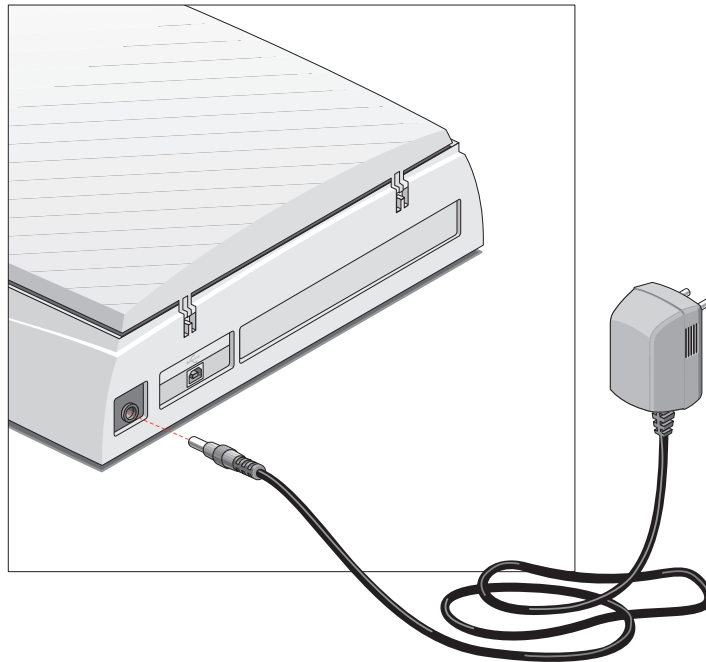

Figure 1

- 3. Connect one end of your USB cable to the USB port on your scanner. Make sure you connect the correct plug as shown in Figure 2.

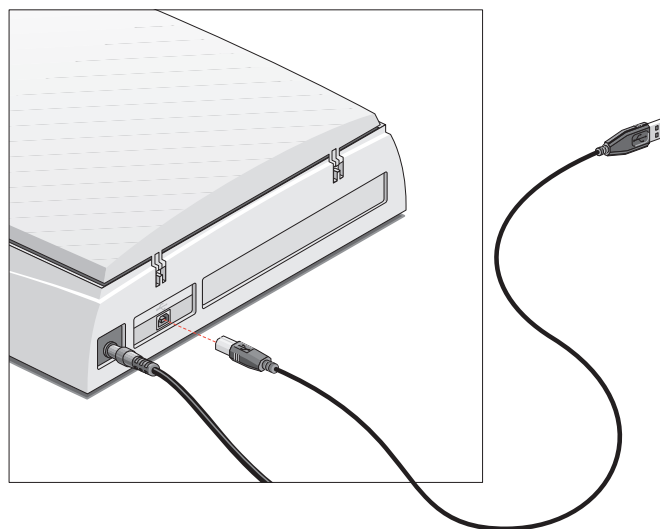



Figure 2

4. Connect the other end of your USB cable to a USB port on your computer. Make sure you connect it to the correct socket as shown in Figure 3. The USB port is labeled with the USB icon . Windows 98 will detect the scanner and will install the necessary files for the scanner hardware driver.

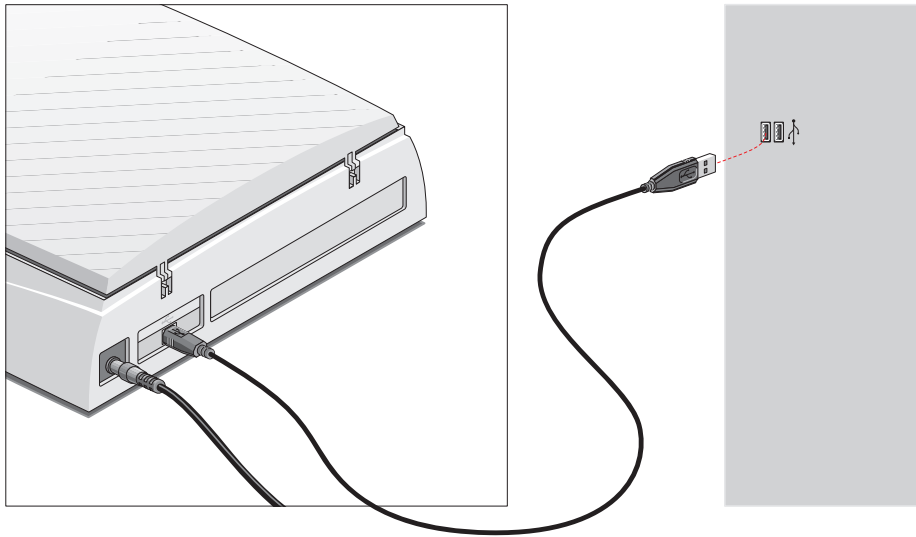

Figure 3

Installing Additional Software

If you want to use OCR (Optical Character Recognition) you will have to install OmniPage. To do so, insert the Caere CD-ROM and follow the instructions on your screen.

To install image editing software, insert the Corel CD-ROM and follow the instructions on your screen.

If the Installer Program does not appear automatically, use the Windows Explorer to install the program.

For a general overview of the possible workflows and to see how the software works together, please refer to the Navigation Map which is supplied with your scanner.

Chapter 3 — Installing the Scanner for Macintosh



This chapter shows you how to set up your SnapScan for your Macintosh.

[Minimum System Requirements](#)

[Installing the Image Editing Software](#)

[Installing the Scanner Software](#)

[Connecting the Scanner to the Macintosh Computer](#)

[Installing Additional Software](#)

Minimum System Requirements

- A USB port
- A PowerPC® processor
- A 14 inch color monitor with thousands of colors for an accurate display of color images
- 32 MB of RAM
- A CD-ROM drive
- System 8® or higher

Installing the Image Editing Software

1. Disable the virus protection software.
You can turn it off in the Extensions Manager Control Panel or you can drag the software out of the System Folder.
 - ❖ Note: After installing, enable the virus protection software again.
2. Restart your computer.
3. Insert the Agfa ScanWise CD-ROM.
4. Double-click the Color It! folder to open it.
5. Double-click the language folder of your choice.
6. Double-click the Install Color It! icon to start the program.
7. Make your choice in every successive screen to install Color It!™ (the image editing software).

Installing the Scanner Software

1. With the Agfa ScanWise CD-ROM still in the CD-ROM drive, double-click the Agfa ScanWise CD-ROM icon.
2. Click the up or down arrow to select your language.



This selection determines the language of the ScanWise software and documentation.

3. Click the up or down arrow to select your type of scanner (if needed).



4. Click the dotted right arrow or move the slider to “about ScanWise”.



A demonstration of ScanWise will start.

5. Click the dotted right arrow or move the slider to “install”.
6. Click ScanWise to start the installation.
7. Follow the instructions on your screen.

When ScanWise is installed, you may be asked to restart your computer. In this case, repeat step 1 to 3 before continuing this procedure. Then click the dotted right arrow or move the slider to “install”.

8. Click Acrobat Reader to start the installation.
You need Acrobat Reader to read the documentation.
9. Follow the instructions on your screen.
When Acrobat Reader is installed you will be asked to restart your computer.

When the installation is finished you are ready to connect your scanner to your Macintosh computer.

- ❖ Note: For the latest information, refer to the ScanWise Read Me File.

Connecting the Scanner to the Macintosh Computer

- ❖ Note: Make sure the scanner is unlocked before connecting it to the electric outlet.
1. Connect the plug of the AC adapter to your scanner (Figure 1).
 2. Plug the adapter in the wall socket.
 - ❖ Note: Check if it complies with your own power supply.

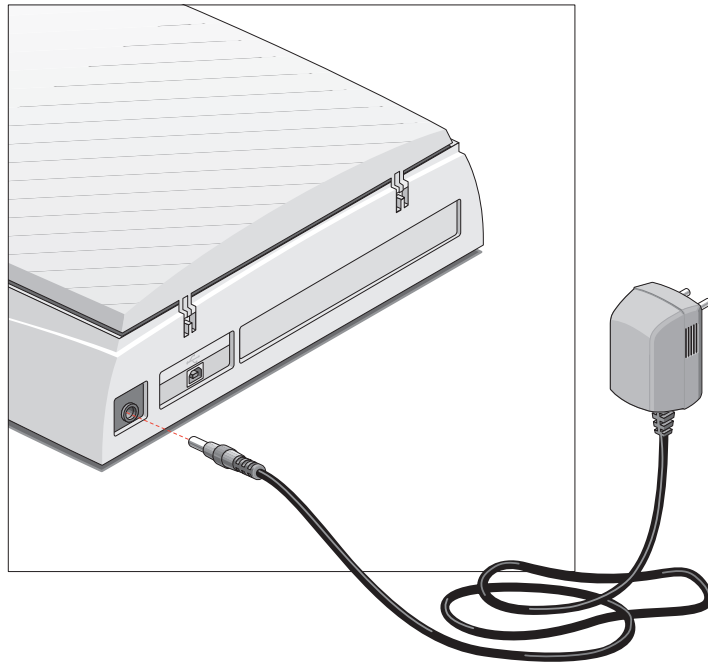

Figure 1

3. Connect one end of your USB cable to the USB port on your scanner. Make sure you connect the correct plug as shown in Figure 2.

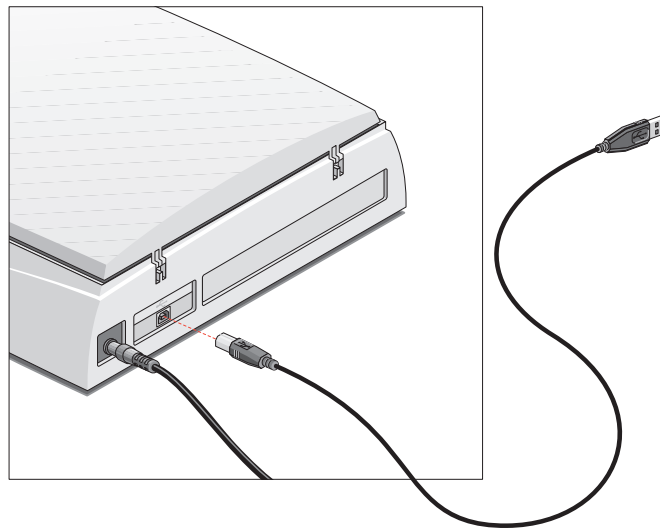



Figure 2

4. Connect the other end of your USB cable to a USB port on your computer. Make sure you connect it to the correct port as shown in Figure 3. A USB port is marked with the USB icon .

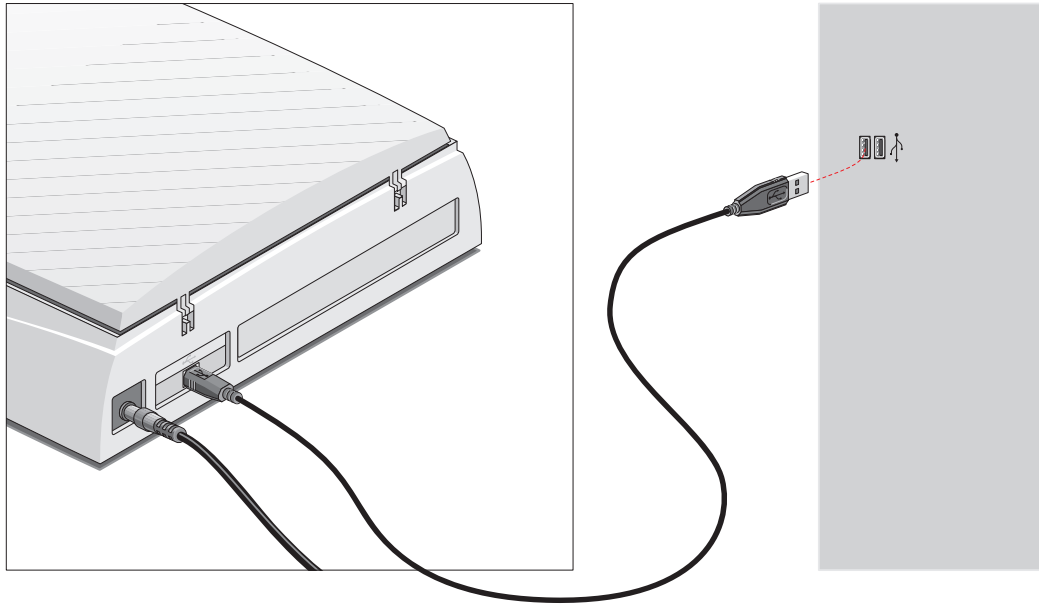

Figure 3

Installing Additional Software

If you want to use OCR (Optical Character Recognition) you will have to install OmniPage LE. To do so, insert the Caere CD-ROM and follow the instructions on your screen.

For a general overview of the possible workflows and to see how the software works together, please refer to the Navigation Map which is supplied with your scanner.

Chapter 4 — Making your First Scan

1. Place a color photograph face down on the glass plate with the top side against the middle of the front ruler.

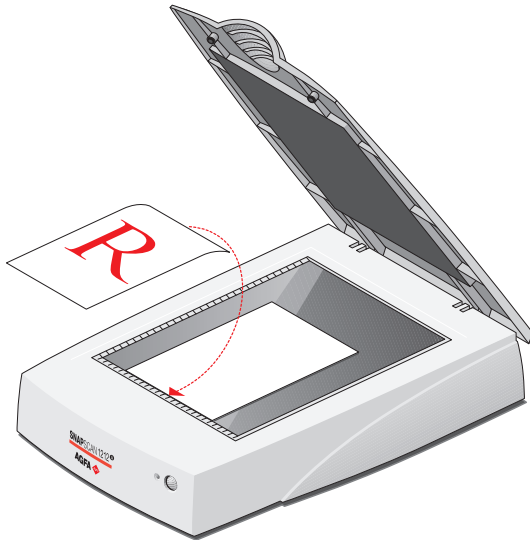

The optical performance of a CCD scanner is always best near the middle of the glass plate. However, the specified scan quality is guaranteed for the entire scan area.

If you put more than one original on the glass plate, position them as close to the center line as possible to optimize quality.

2. Lower the document cover of the scanner.
 - ❖ Note: The adjustable document cover makes it possible to scan from books and magazines. When you put a thick original on the reflective glass plate, the document cover adapts to the thickness of the original.
3. Double-click the Agfa ScanWise application icon on your Macintosh computer or select Programs, Agfa ScanWise in the Start menu on your PC.
4. Select your scanner (if needed).
 - ❖ Note: This dialog only appears the first time you use ScanWise.
5. Click 'Yes' when the system asks to guide you.
6. Follow the steps described in the ScanWise Guide Me mode.

For more information refer to the ScanWise Application Guide and the Technical Support document (here you find all Agfa local support centers and other software suppliers). After installation you can access these documents.

- ❖ Note: If you encounter problems, please refer to the ScanWise Read Me file on your computer or to the Troubleshooting section in this Owner's Guide.

Appendix A — Troubleshooting

This section gives solutions for some common problems you may come across when starting up or using your SnapScan.

There's no USB port free for your scanner.

- Check if you can use a USB port on the keyboard or monitor.
- Use a USB hub.

The [status indicator](#) fails to light up.

- Verify the power connection to the scanner.
- If the power connection is working, contact your dealer or local Agfa support center.

The scanner makes an unusual noise and the scanner lamp does not move back and forth when you connect the scanner.

- The scanner was not properly unlocked. Immediately disconnect the AC adapter and [unlock](#) the scanner properly, or contact your dealer or local Agfa support center.

The status indicator on the scanner's operating panel starts blinking at a higher frequency after the power-up sequence (= 15 seconds).

A malfunction has been detected by the scanner.

- Check if you have unlocked the scanner.
- Disconnect the AC adapter and connect it again.
- If this does not help, please contact your dealer or local Agfa support center.

The scanner lamp flickers, dims, or fails to come on.

- The cold cathode lamp needs to be replaced. Contact your dealer or local Agfa support center.

ScanWise cannot find the scanner.

If the scanner driver cannot find the scanner, a message appears telling you that no scanner is connected.

- Check if the scanner is connected with the USB cable to your computer and that the AC adapter is plugged in. It can always happen that a USB port is damaged, therefore try the other USB port of your computer.
- Ensure the scanner is powered on.
- **MACINTOSH ONLY**
Open the Apple System Profiler (you find this under the  menu). Click the tab 'Devices and Volumes' (Minimum system 8.5). Here you can check if the USB device is found. If USB is not present in the list of 'Devices and Volumes', please check the hardware (cable, USB ports, ...).
- Disconnect the AC adapter plug and reconnect it again.
- ❖ Note: If you encounter other problems during or after installation, please refer to the ScanWise Read Me file on your computer.

The driver is not found when you connect the scanner to your computer (MACINTOSH ONLY).

If ScanWise is not installed correctly, the following message appears: "The software needed to use the device SnapScan 1212u cannot be found".

- Re-install ScanWise.
- Check if the Extensions folder contains the file 'Agfa USB 1212u'. This driver is necessary for detecting the scanner.

When Windows 98 fails to detect the scanner when you connect it for the first time (PC ONLY)

- Check if the scanner is connected with the USB cable to your computer and that the AC adapter is plugged in. It can always happen that a USB port is damaged, therefore try the other USB port of your computer.
- Check if the Device Manager finds the USB controller. To check if the USB controller is present in the Device Manager, click with the right mouse button on the icon My Computer and select Properties from the menu that pops up. Select the Device Manager tab from the System Properties dialog box.
 - If the USB controller () is present in the Device Manager, carry out the scanner installation procedure **exactly** as described in this manual.
 - If the USB controller **is not** present in the Device Manager, carry out the following instructions:

1. Restart your computer.
2. Enable the USB controller in the BIOS settings.

Caution: Changing your computer's BIOS settings is at your own risk! It should be done by system administrators and experienced users only. If you are not familiar with these tasks, ask your computer dealer to do this for you.

You typically do this by pressing a key combination during the startup of your PC. Refer to your computer manual for more information.

3. Exit and save the changes you made.
Your computer is rebooted automatically.

- Check again if the Universal serial bus controller is present in the Device Manager.
 - If the Universal serial bus () controller **is** present in the Device Manager, carry out the scanner installation procedure **exactly** as described in this manual.
 - If the Universal serial bus controller **is still not** present in the Device Manager, carry out the following instructions:
 1. Click the Start button.
 2. Select Settings.
 3. Select Control Panel.
 4. Double-click on the Add New Hardware icon.
 5. **Attentively** follow the instructions that appear on your screen.

The Universal serial bus controller should now be present in the Device Manager. Carry out the scanner installation procedure **exactly** as described in this manual.

A OEM Windows 98 system was already installed when purchasing your computer

When you encounter problems during the installation procedure on a PC with a pre-installed Windows 98 system, please contact your PC dealer.

Appendix B — Technical Information

Technical specifications are subject to change without notice.

Scanner type:	Desktop, flatbed, one pass
Maximum resolution: - optical: - through interpolation:	600 ppi horizontal x 1200 ppi vertical 9600 ppi horizontal x 9600 ppi vertical
Internal sample depth:	12 bits for gray, 48 bits for color
Scanning speed: - line-art: - gray: - color:	3,5 ms / line 3,5 ms / line 10,5 ms / line
Maximum scanning area:	216 x 297 mm (8.5 " x 11.7 ")
Lamp:	cold cathode
Power-on to ready time:	≤ 15 seconds
AC adapter: - input voltage: - input frequency: - output:	100 to 240 VAC 47 to 63 Hz 16 VDC — 0,9 A
Dimensions: - length: - width: - height: - weight:	445 mm 330 mm 105 mm ca. 4 kg
Interface:	USB port 1 USB connector
Transmission speed:	1 Mbyte/s
Environmental specifications: - operating temperature: - relative humidity: - surrounding space:	+10 °C to +40 °C (+50 to +104 degrees Fahrenheit) 20% to 85% RH 10 cm on every side

Appendix C — Regulation Compliance

[Safety Regulations](#)

[Electromagnetic Compatibility](#)

Safety Regulations

SnapScan and its options are designed to comply with:

- UL 1950-D3
- CSA C22.2 No. 950 - M89 D3
- VDE 0805
- IEC 950
- GS approved
- EN 60950

UL Safety Statement

The SnapScan and the AC adapter are suited for indoor use only. Do not use them outdoors.

Use the Agfa supplied AC adapter only. Otherwise guarantee will be voided.

For the reason of safety, besides the personal maintenance mentioned in this operation manual, do not try to remove any mechanical parts or any electronic devices. If your scanner needs service, our dealer and service offices are available to help you.

TÜV: Wichtige Sicherheitshinweise

1. Bitte Lesen Sie sich diese Hinweise sorgfältig durch.
2. Um eine Beschädigung des Gerätes zu vermeiden sollten Sie nur Zuberhörteile verwenden, die vom Hersteller zugelassen sind.
3. Das Gerät ist vor Feuchtigkeit zu schützen.
4. Bei der Aufstellung des Gerätes ist auf sicheren Stand zu achten. Ein Kippen oder Fallen könnte Verletzungen hervorrufen. Verwenden Sie nur sichere Standorte und beachten Sie die Aufstellhinweise des Herstellers.
5. Die Belüftungsöffnungen dienen zur Luftzirkulation die das Gerät vor Überhitzung schützt. Sorgen Sie dafür, daß diese Öffnungen nicht abgedeckt werden.
6. Die Netzanschlußsteckdose muß aus Gründen der elektrischen Sicherheit einen Schutzleiterkontakt haben.
7. Durch die Lüftungsöffnungen dürfen niemals Gegenstände oder Flüssigkeiten in das Gerät gelangen. Dies könnte einen Brand bzw. elektrischen Schlag auslösen.
8. Öffnen Sie niemals das Gerät. Das Gerät darf aus Gründen der elektrischen Sicherheit nur von autorisiertem Servicepersonal geöffnet werden.
9. Die Steckdose sollte nahe dem Gerät und leicht zugänglich sein.

Electromagnetic Compatibility

SnapScan is designed to comply with:

- Emission EN55022, class B
- Immunity IEC 801-2, IEC 801-3, IEC 801-4
- 47 CFR, part 15, subpart B, class B

Federal Communications Commission Radio Frequency Interference Statement

This equipment has been tested and found to comply with the limits for a Class B digital device, pursuant to Part 15 of the FCC Rules. These limits are designed to provide reasonable protection against harmful interference when the equipment is operated in a residential installation. This equipment generates, uses, and can radiate radio frequency energy and, if not installed and used in accordance with the instruction manual, may cause harmful interference to radio communications. However, there is no guarantee that interference will not occur in a particular installation. If this equipment does cause harmful interference to radio or television reception, which can be determined by turning the equipment off and on, the user is encouraged to try to correct the interference by one or more of the following measures:

- Reorient or relocate the receiving antenna.
- Increase the separation between the equipment and receiver.
- Connect the equipment into an outlet on a circuit different from that to which the receiver is connected.
- Consult the dealer or an experienced radio/television technician for help.

Industry Canada Class A and B Label Requirements

This Class [select A or B] digital apparatus meets all the requirements of the Canadian Interference Causing Equipment Regulations.

Cet appareil numérique de la classe [A/B] respecte toutes les exigences du Règlement sur le matériel brouilleur du Canada.