

SnapScan 1200P

Owner's Guide



[Preface](#)

This chapter gives you information about SnapScan™ 1200P, about the organization, and about [how to use this online guide](#).

[Chapter 1 — Preparing the Scanner](#)

“Preparing the Scanner” explains how to prepare your SnapScan 1200P for installation.

[Chapter 2 — Installing the Scanner](#)

This chapter shows you how to set up your SnapScan 1200P.

[Appendix A — Troubleshooting](#)

“Troubleshooting” can be helpful when you come across problems.

[Appendix B — Technical Information](#)

This appendix provides specifications for your SnapScan 1200P.

[Appendix C — Regulation Compliance](#)

This appendix gives you information about safety regulations and electromagnetic compatibility.



The complete picture.

Trademarks

AGFA and the Agfa rhombus are registered trademarks of Agfa-Gevaert AG.

FotoLook, FotoSnap and SnapScan are trademarks of Agfa-Gevaert N.V.

Acrobat is a trademark of Adobe Systems Incorporated which may be registered in certain jurisdictions.

Hewlett-Packard and HP are registered trademarks of Hewlett-Packard Company.

IBM PC is a trademark of International Business Machines Corporation.

Intel and Pentium are registered trademarks of Intel Corporation.

lomega is a registered trademark of lomega Corporation.

iPhoto Express is a trademark of Ulead.

Windows and Windows NT are trademarks or registered trademarks of Microsoft Corporation.

Other product or company names are trademarks or registered trademarks of their respective holders.

Copyright © 1998 Agfa-Gevaert N.V.

All rights reserved.

All software and hardware described in this document are subject to change without any notice.

Conventions

The following conventions are used in this guide:

- ❖ Note: a note of this type gives you additional information.
 - Instructions are preceded by a small red square.
1. Numbered steps describe the actions you must take to perform a task.

Contents

Preface	4
About SnapScan 1200P	5
Environmental Requirements	5
Precautions	6
Cleaning your Scanner.....	6
How to Use this Guide	7
How to Print this Online Guide	8
Chapter 1 — Preparing the Scanner	9
Unpacking the Scanner.....	10
Unlocking the Scanner.....	10
Locking the Scanner	11
Taking a Closer Look	12
Chapter 2 — Installing the Scanner	14
Minimum Hardware Requirements	15
Installation of the Scanner Hardware.....	15
Connecting the Scanner	16
Testing the Scanner	18
Installing the Software	19
Installing Additional Software	19
Placing Reflective Originals	20
Appendix A — Troubleshooting	21
Appendix B — Technical Information	24
Appendix C — Regulation Compliance	25
Safety Regulations	26
UL Safety Statement.....	26
TÜV: Wichtige Sicherheitshinweise.....	26
Electromagnetic Compatibility	27
Federal Communications Commission Radio Frequency Interference Statement	27
Industry Canada Class A and B Label Requirements	27

Preface

[About SnapScan 1200P](#)

[Environmental Requirements](#)

[Precautions](#)

[Cleaning your Scanner](#)

[How to Use this Guide](#)

[How to Print this Online Guide](#)

About SnapScan 1200P

In this Owner's Guide the name SnapScan is used for SnapScan 1200P.

The SnapScan is a one pass flatbed color scanner with a resolution of 600 x 1200 ppi equipped with a cold cathode lamp. It is based on CCD (Charge Coupled Device) scanning technology. With the SnapScan, you can scan line-art, gray-scale and color reflective originals up to A4 format.

The scanned data is transferred through the computer's parallel port.

SnapScan is a scanner that captures and converts reflective originals (for example pictures, text) into electronic data that can be used in computer applications. It offers high-resolution image capturing and is an ideal tool in making presentations come to life.

SnapScan supports multiple scanning modes and includes scanner software to get you started right away. With its powerful and easy-to-use scanner driver software, SnapScan gives you easy access to high-quality color scans. The scanner driver software gives you a number of additional features to create special effects or to reproduce even the most difficult originals.

The document cover is adjustable: when you put a thick original (like a book or a magazine) on the reflective glass plate, the document cover adapts to the thickness of the original.

Environmental Requirements

- Place the scanner on a horizontal, flat surface.
- To ensure proper ventilation, allow a minimum of 10 cm (4 inches) free space around each side of the scanner.
- Make sure that no vibrations or shocks occur.
- Make sure that the area is free of dust.
- Avoid any contact with water. Do not use your scanner near water or in a damp environment.
- Your SnapScan is designed to perform at best when the environmental humidity is between 20% and 85%. Avoid environments where humidity fluctuations might occur.
- Your SnapScan is designed to perform at best when the environmental temperature is between 10°C and 40°C (+50 and +104 degrees Fahrenheit). Avoid exposure to direct sunlight and heating devices.
- Avoid environments where voltage fluctuations might occur.

Precautions

For your own safety and that of your equipment, respect conscientiously the [Environmental Requirements](#) and always take the following precautions:





Caution: For the reason of safety, besides the personal maintenance mentioned in this Owner's Guide, do not try to remove any mechanical parts or any electronic devices. If your scanner needs service, our dealer and service offices are available to help you.

- Handle your SnapScan with care: the glass plate is fragile. There is no warranty on breaking the glass plate and your dealer is not liable for consequential damages.
- Check frequently whether there is no overheating of the AC adapter and whether the adapter is pushed all the way into the socket.
- Switch off the machine at the end of your working day or during power failure.
- Disconnect the AC-adapter when you want to clean the scanner housing or the glass plate and when the scanner needs servicing or repairing.
- Do not open the scanner housing as it contains high-voltage areas and sensitive components. Every repair should be carried out by your dealer.
- Do not leave originals on the reflective glass plate for excessive periods of time. The warmth of the scanner may cause them to deteriorate.
- For safety reasons, never use extension cables for the AC-adapter or for power cords.

Cleaning your Scanner

- Cleaning the glass plate regularly, ensures that dirt or smudges do not reduce the quality of your scanned images.
- Before cleaning, switch off the power of the scanner and disconnect the AC-adapter.
- Use a soft damp cloth and a mild detergent to clean the surface of the glass plate. If you use alcohol to clean the glass plate, make sure that you do not touch the plastic elements of the scanner.
- Avoid using sprays directly onto the glass plate as this may cause the liquid to penetrate the seams around the glass and contaminate the mirrors and lenses inside the scanner.
- Do not use liquid cleaners or aerosol cleaners.

How to Use this Guide

<p>Chapter 1, "Installing FotoLook"</p> <p>Chapter 2, "FotoLook reference"</p> <p>Chapter 3, "Setting up your monitor"</p> <p>Chapter 4, "Profile Setup in FotoLook"</p>	<p>Click any text or graphic that is identified as hypertext link. The arrow pointer changes into an index finger when positioned over a link.</p> <p>Underlined text is "linked" to another part of this guide.</p>
<ul style="list-style-type: none"> ▷ □ Preface ▷ □ 1— Installing FotoLook ▷ □ 2— FotoLook reference ▷ □ 3— Setting up your monitor ▷ □ 4— Profile Setup in FotoLook 	<p>Click on the bookmark name to go to the topic marked by that bookmark. Click the triangle to the left of a bookmark to show and hide subordinate bookmarks.</p>
	<p>Use the First Page or Last Page button to move the document to the first or last page of this manual.</p>
	<p>Use the Go Back and Go Forward buttons to retrace your steps in this guide, moving to each view in the order visited.</p>
	<p>Use the Previous Page or Next Page button to move the document backward or forward, one page at a time.</p> <p>You can also use the keyboard arrows.</p>
	<p>Use the zoom tool to magnify and reduce (Control-click) the page display.</p>
	<p>Click the Find button to search for part of a word, a complete word, or multiple words in this document. You can also consult the supplied index.</p>
<p>Print</p>	<p>Choose Print from the File menu to print this online guide.</p>

How to Print this Online Guide

1. Choose Page Setup from the File menu.
2. Choose your paper format from the Paper pop-up menu.
3. Select Orientation: Portrait.
4. Click OK.
5. Choose Print from the File menu.

Chapter 1 — Preparing the Scanner

This chapter helps you to prepare your SnapScan for installation.

[Unpacking the Scanner](#)

[Unlocking the Scanner](#)

[Locking the Scanner](#)

[Taking a Closer Look](#)

Unpacking the Scanner

1. Open the packing box and carefully take out all the items.
2. Check each item to make sure that you have everything listed on the box and on the Packing List. Check if there is no visible defect.
If something is missing, contact your dealer.
3. Remove the plastic wrapping and the packing materials from the scanner.
 - ❖ Note: Save the packing materials to protect the scanner during later transport.

Unlocking the Scanner

The scanner's optical box contains all optical components and rides back and forth during the scan. A locking slider holds it in place during shipment. Before you switch on the scanner, you first have to unlock it.

1. Place the scanner on a horizontal, flat surface and pull it carefully towards you until you can see the locking slider at the bottom.
2. Slide the locking slider to the right.
Your scanner is unlocked.

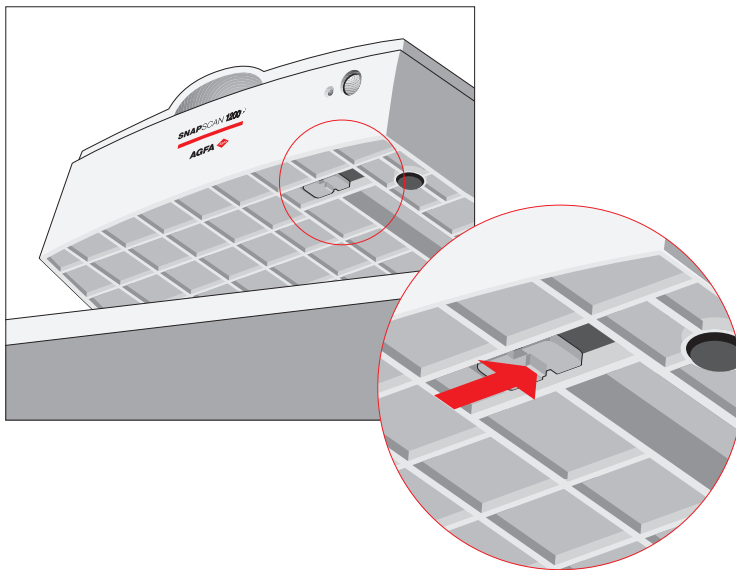

3. Move the scanner back on your desktop. Allow a minimum of 10 cm (4 inches) free space around each side of the scanner.

Locking the Scanner

If you have to transport the scanner, you should first lock it. This will protect the scanner's optical carriage from possible damage.

1. Place the scanner on a horizontal, flat surface and pull it towards you until you can see the locking slider at the bottom.
2. Switch on your scanner.
The scanner's optical assembly moves to its home position.
3. When the status indicator stops blinking, slide the locking slider to the left.
Your scanner is locked.
4. Switch off your scanner.



Taking a Closer Look

Now that you have the scanner out of the box, take a closer look so that you become familiar with its parts. The figures illustrate the locations of the different parts of your SnapScan.

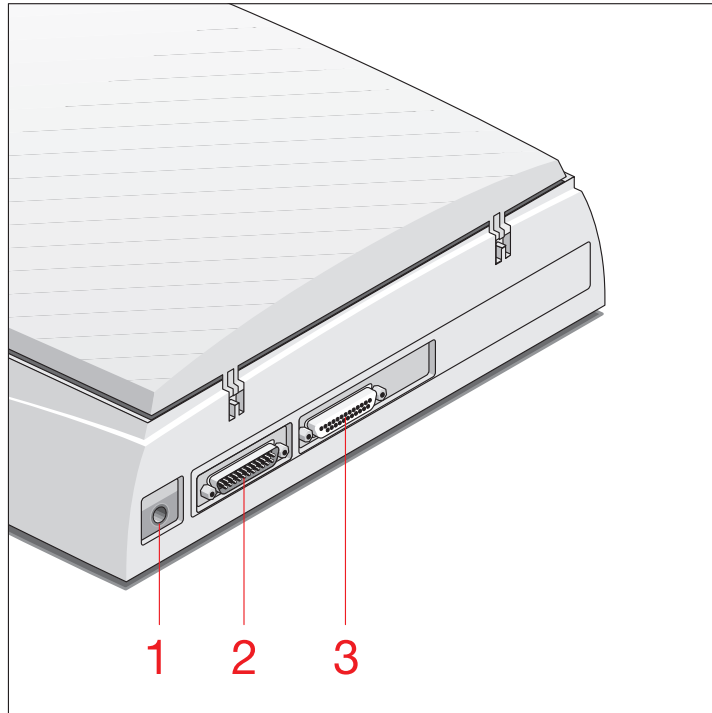

1. glass plate
2. adjustable document cover
3. rulers
4. power switch
5. power indicator / status indicator



1. AC adapter connector
2. 25-pin interface plug (marked with a computer icon ) for connection to your PC
3. 25-pin interface socket (marked with a printer icon ) for connection to your printer

Chapter 2 — Installing the Scanner

This chapter shows you how to set up your SnapScan.

[Minimum Hardware Requirements](#)

[Installation of the Scanner Hardware](#)

[Connecting the Scanner](#)

[Testing the Scanner](#)

[Installing the Software](#)

[Installing Additional Software](#)

[Placing Reflective Originals](#)

Minimum Hardware Requirements

- A Pentium processor
- A 14 inch color monitor
- A 16-bit video card for an accurate display of color images (minimum 256 colors / High Color (16bit) is recommended)
- 16 MB of RAM (32 MB of RAM is recommended)
- FotoLook and FotoSnap are compatible with all IBM™ PCs and compatibles capable of running Windows™95, Windows 98 or Windows NT™ 4.0 for Intel® platforms.
- A CD-ROM drive
- The amount of disk space available on your PC determines the number and the size of the images that you can scan. Make sure that you have enough free storage space on your hard disk. You need about two times the size of the image to scan, edit and save it.

Installation of the Scanner Hardware

This section shows you how to set up your SnapScan with your PC and your printer. You can find instructions for connecting the scanner and instructions for testing the scanner.

Connecting the Scanner

1. Switch off your computer and your printer and disconnect the power cords.
2. Remove the printer cable from the printer port of your computer.
3. Put the plug of the Parallel Interface cable into the printer port of your computer.

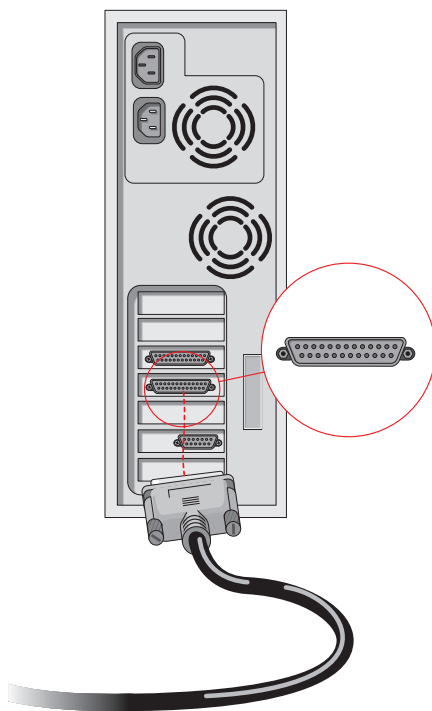

Caution: Make sure to plug the Parallel Interface cable into the printer port and not into any other resembling port. If damage caused by wrong connection occurs, warranty will be voided.

4. Connect the socket of the Parallel Interface cable to the plug (marked with a computer icon ) at the rear of the scanner.

❖ Note: Do not forget to secure the connection by tightening the connector screws.

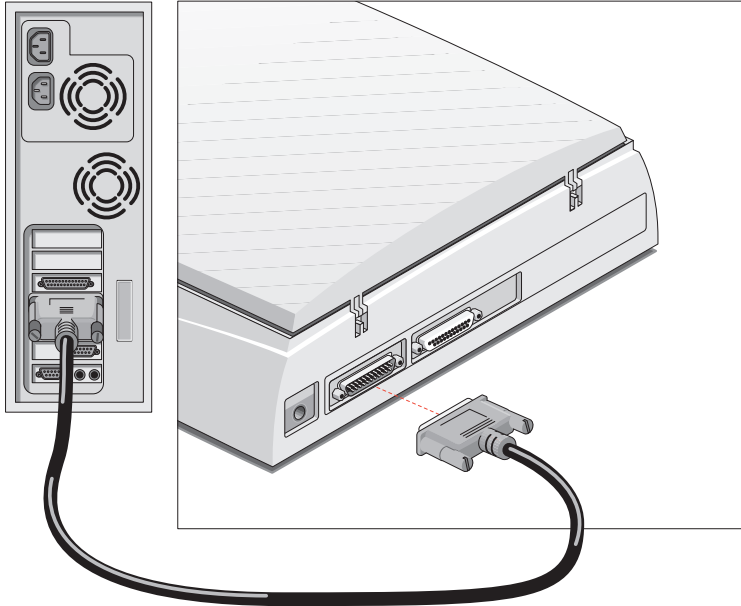

5. Connect the printer cable to the socket (marked with a printer icon ) at the rear of the scanner.

❖ Note: Do not forget to secure the connection by tightening the connector screws.

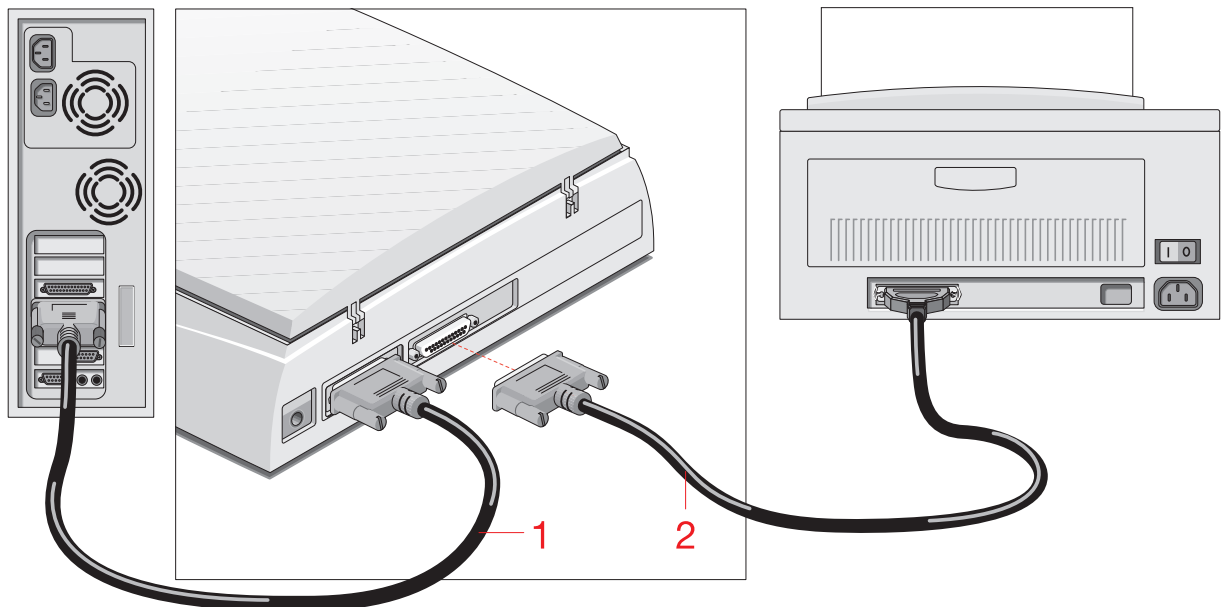

1. Parallel Interface cable
2. printer cable

6. Connect the power cord to your computer and your printer.
 - ❖ Note: Make sure that you are using the correct power cord for the voltage in your area. If it does not correspond, contact your dealer.
7. Connect the AC-adaptor to the scanner.



Testing the Scanner

You are now ready to perform a test to check if the scanner is properly connected to your PC.

Caution: Check if the scanner is properly [unlocked](#).

1. Switch on the scanner.

The scanner performs a self-test during which the status indicator blinks slowly. This takes about 15 seconds or less. After the self-test the status indicator remains on.

 - ❖ Note: If a malfunction is detected during the self-test, that is, if the status indicator starts blinking at a higher frequency, refer to [Appendix A — Troubleshooting](#).
2. Switch on any other device that you may have attached, and wait for it to start up.
3. Switch on your computer and your printer.

Installing the Software

1. Switch on your scanner and your computer.
2. Insert the Software Collection I CD-ROM in your CD-ROM drive.
Windows should detect the CD-ROM and then automatically run the installation program. If it does not run the program, double-click the Softcol 1 icon in 'My Computer' to install iPhoto Express (the image editing software).
3. Remove the CD-ROM from your CD-ROM drive.
4. Insert the Agfa Scanners CD-ROM into your CD-ROM drive.
Windows should detect the CD-ROM and then automatically run the installation program. If it does not run the program, double-click the AgfaScan icon in 'My Computer'.
5. Click your language: International English.
You will be asked if you want to install Acrobat™. You need Acrobat to read your documentation.
6. Choose your scanner: SnapScan 1200P.
7. Click Install software.
8. Click Register.
Fill in the registration form, print it out and send it to the correct address.

❖ Note: You can find the product serial number at the rear of your scanner.
9. Install FotoLook™ (the professional scanner driver) and/or FotoSnap™ (the easy-to-use scanner driver) by following the instructions on your screen.

When the software installation is finished, you may be asked to restart your computer.

For the latest up-to-date information, refer to the FotoLook Read Me file and the FotoSnap Read Me file on your computer.

Installing Additional Software

To install additional software, insert the Software Collection II CD-ROM and follow the instructions on your screen.

For a general overview of the additional software and for the location of the documentation, please refer to the Navigation Map which is supplied with your scanner.

Placing Reflective Originals

You can place a reflective (photographic) original directly on the scanner's glass plate.

The following steps explain how to position your reflective original on your scanner.

1. Open the document cover of the scanner.
2. Place the original face down on the glass plate with the top side against the middle of the front ruler.



The optical performance of a CCD scanner is always best near the middle of the glass plate. However, the specified scan quality is guaranteed for the entire scan area.

If you put more than one original on the glass plate, position them as close to the center line as possible to optimize quality.

3. Lower the document cover of the scanner.
The adjustable document cover makes it possible to scan from books and magazines. When you put a thick original on the reflective glass plate, the document cover adapts to the thickness of the original.

Appendix A — Troubleshooting

This section gives solutions for some common problems you may come across when starting up or using your SnapScan.

Caution: Before you contact your dealer or local Agfa support center, first refer to the question.wri file which you can find in the FotoLook directory.

The scanner lamp flickers, dims, or fails to come on.

- The cold cathode lamp needs to be changed. Contact your dealer or local Agfa support center.

The scanner does not start up.

- Contact your dealer or local Agfa support center.

The scanner makes an unusual noise and nothing moves under the glass plate when you switch on the scanner.

- The scanner was not properly unlocked. Immediately switch off the scanner and [unlock](#) it properly, or contact your dealer or local Agfa support center.

The status indicator on the scanner's operating panel starts blinking at a higher frequency after the power-up sequence (= 15 seconds).

A malfunction has been detected by the scanner.

- Check if you have [unlocked](#) the scanner.
- Switch off the scanner and switch it back on.
- If this does not help, please contact your dealer or local Agfa support center.

The power indicator / status indicator fails to light up.

- Verify the power connection to the scanner.
- Check if the [power switch](#) is turned on.
- If you are sure that the scanner is powered on, contact your dealer or local Agfa support center.

The scanner software cannot find the scanner.

After opening the Scan dialog box, a message appears telling you that no scanner is connected, although the scanner is connected.

- Check whether the [Parallel Interface cable](#) is properly connected.
- Reboot your computer after you have installed the FotoLook software.
- ❖ Note: If you encounter other problems during or after installation, please refer to the EPP section in the FotoLook Read Me file on your computer.

The scanner behaves extremely slow.

After opening the Scan dialog box, a message appears telling you that the parallel port of your computer is configured at a slow mode.

Caution: To solve this problem, your computer's BIOS settings have to be reconfigured. Changing these BIOS settings by yourself is at your own risk! It should be done by system administrators and experienced users only.

- Try to change the Parallel Port mode in your computer BIOS settings. You typically do this by pressing a key combination during the start-up of your PC. Refer to your computer manual for more information.
The Parallel Port mode should only be changed to EPP, EPP + ECP (Enhanced Capability Port) or ECP mode:
 - If you cannot change the Parallel Port mode to one of these modes, leave the settings untouched.
 - If you can choose between several of these modes, always select the mode occurring first in the following row: EPP, EPP + ECP or ECP.

In case of problems, contact your PC dealer or your system administrator to change the settings.

Using your scanner with other parallel port devices.

If you encounter difficulties using your scanner with other parallel port devices, we recommend the following:

1. Connect your scanner to the first printer port (LPT1) and make sure that it is powered on before you start up your computer.
2. Connect the scanner as the first device and connect other parallel devices to the second connector at the back of the scanner. Always use the cable that came with your scanner to connect it to your computer.
3. Never use two parallel port devices simultaneously! This does not mean that you cannot connect more than one device, it means that you cannot access both devices at the same time. For example: do not attempt to scan while your printer is busy.

4. Upgrade the drivers for your other parallel port devices to the latest versions. Contact the manufacturer of these devices if you do not know how to update these drivers.

Your Agfa SnapScan is compatible with the Iomega™ / HP™ / Microsoft™ protocol for sharing the parallel port. This protocol is implemented on Windows 95 and Windows NT 4.0.

Due to the nature of the parallel port interface we can not guarantee compatibility with other parallel port devices (or their drivers) if they are not compatible with the above-mentioned protocol.

Simultaneous operation of two (or more) devices on the printer port is very likely to cause severe problems: scanning while printing, scanning directly to a parallel port removable drive and so on, may cause unexpected results.

Your PC has two printer ports.

If your PC has two printer ports, connect the scanner to the first printer port (LPT1). If you connect the scanner to the second printer port, your operating system will not recognize it.

Appendix B — Technical Information

Technical specifications are subject to change without notice.

Scanner type:	Desktop, flatbed, one pass
Maximum resolution: - optical: - through interpolation:	600 ppi horizontal x 1200 ppi vertical 9600 ppi horizontal x 9600 ppi vertical
Internal sample depth:	10 bits for gray, 30 bits for color
Scanning speed: - line-art: - gray: - color:	3 ms / line 3 ms / line 8 ms / line
Maximum scanning area:	216 x 297 mm (8.5 x 11.7 inch)
Lamp:	cold cathode
Power-on to ready time:	≤ 15 seconds
Power supply: - voltage: - frequency:	100 V to 240 V 47 Hz to 63 Hz
Dimensions: - length: - width: - height: - weight:	440 mm (17.5 inch) 320 mm (13 inch) 110 mm (4.3 inch) ca. 4kg (1.8 lb)
Interface:	parallel port 2 x 25-pin connector
Transmission speed:	1 Mbyte/s
Environmental specifications: - operating temperature: - relative humidity: - surrounding space:	10°C to 40°C (+50 to +104 degrees Fahrenheit) 20% to 85% RH 10 cm (4 inches) on every side

Appendix C — Regulation Compliance

[Safety Regulations](#)

[Electromagnetic Compatibility](#)

Safety Regulations

SnapScan is designed to comply with:

- UL 1950-D3
- CSA C22.2 No. 950 - M89 D3
- VDE 0805
- IEC 950
- GS approved
- EN 60950

UL Safety Statement

Instructions for power supply cord selection:

For modules set at 115V:

Use a UL listed, Type SVT or SJT cord, three conductor, rated 10 A 125 V, not to exceed 15ft in length.

Caution: For the reason of safety, besides the personal maintenance mentioned in this operation manual, do not try to remove any mechanical parts or any electronic devices. If your scanner needs service, our dealer and service offices are available to help you.

TÜV: Wichtige Sicherheitshinweise

1. Bitte Lesen Sie sich diese Hinweise sorgfältig durch.
2. Um eine Beschädigung des Gerätes zu vermeiden sollten Sie nur Zuberhörteile verwenden, die vom Hersteller zugelassen sind.
3. Das Gerät ist vor Feuchtigkeit zu schützen.
4. Bei der Aufstellung des Gerätes ist auf sicheren Stand zu achten. Ein Kippen oder Fallen könnte Verletzungen hervorrufen. Verwenden Sie nur sichere Standorte und beachten Sie die Aufstellhinweise des Herstellers.
5. Die Belüftungsöffnungen dienen zur Luftzirkulation die das Gerät vor Überhitzung schützt. Sorgen Sie dafür, daß diese Öffnungen nicht abgedeckt werden.
6. Die Netzanschlußsteckdose muß aus Gründen der elektrischen Sicherheit einen Schutzleiterkontakt haben.
7. Durch die Lüftungsöffnungen dürfen niemals Gegenstände oder Flüssigkeiten in das Gerät gelangen. Dies könnte einen Brand bzw. elektrischen Schlag auslösen.

8. Öffnen Sie niemals das Gerät. Das Gerät darf aus Gründen der elektrischen Sicherheit nur von autorisiertem Servicepersonal geöffnet werden.
9. Die Steckdose sollte nahe dem Gerät und leicht zugänglich sein.

Electromagnetic Compatibility

SnapScan is designed to comply with:

- Emission EN55022, class B
- Immunity IEC 801-2, IEC 801-3, IEC 801-4
- 47 CFR, part 15, subpart B, class B

Federal Communications Commission Radio Frequency Interference Statement

This equipment has been tested and found to comply with the limits for a Class B digital device, pursuant to Part 15 of the FCC Rules. These limits are designed to provide reasonable protection against harmful interference when the equipment is operated in a residential installation. This equipment generates, uses, and can radiate radio frequency energy and, if not installed and used in accordance with the instruction manual, may cause harmful interference to radio communications. However, there is no guarantee that interference will not occur in a particular installation. If this equipment does cause harmful interference to radio or television reception, which can be determined by turning the equipment off and on, the user is encouraged to try to correct the interference by one or more of the following measures:

- Reorient or relocate the receiving antenna.
- Increase the separation between the equipment and receiver.
- Connect the equipment into an outlet on a circuit different from that to which the receiver is connected.
- Consult the dealer or an experienced radio/television technician for help.

Industry Canada Class A and B Label Requirements

This Class [select A or B] digital apparatus meets all the requirements of the Canadian Interference Causing Equipment Regulations.

Cet appareil numérique de la classe [A/B] respecte toutes les exigences du Règlement sur le matériel brouilleur du Canada.