

AQUOS *SERIE*

SHV32

Basic Manual

- The company names and product names appearing in this manual are trademarks or registered trademarks of their respective holders.
- For exemptions, refer to "Notes on Usage" available on the au homepage.

May 2015, 1st Edition

For inquiries, call:

Customer Service Center

For general information, charges, and operation assistance (toll free)

Business hours: 9:00 to 20:00 (7 days a week)

From fixed-line phones: | From au cell phones:

0077-7-111 | 157 area code not required

Pressing "zero" will connect you to an operator, after calling "157" on your au cellphone.

For service cancellation procedure in case of loss or theft (toll free)

Business hours: 24 hours (7 days a week)

From fixed-line phones: | From au cell phones:

0077-7-113 | 113 area code not required

In case above numbers are not available, call toll-free:

0120-977-033 (except Okinawa)

0120-977-699 (Okinawa)

Keitai Guarantee Service Center

For loss, theft or damage (toll free)

Business hours: 9:00 to 21:00 (7 days a week)

From fixed-line phones/au cell phones:

0120-925-919



やめましょう、
歩きスマホ。



モバイル・リサイクル・ネットワーク
詳細情報は各のウェブサイトでご覧も。

Cell phone and PHS operators collect and recycle unused telephones, batteries and battery chargers at stores bearing the logo regardless of brand and manufacturer to protect the environment and reuse valuable resources.

Preface

Thank you for buying the "AQUOS SERIE SHV32" (simply called the "SHV32" or the "product" from here on).

Before using the product, be sure to read the "Basic Manual" (this manual) and "Notes on Usage"/"Setting Guide" available on the au homepage to ensure correct use. After you have finished reading the manuals, be sure to keep them accessible and store the printed manuals ("取扱説明書" (Basic Manual), "ご利用にあたっての注意事項" (Notes on Usage) and "設定ガイド" (Setting Guide)) (Accessories) in safe places so that you can refer to them whenever you need them. If you lose the printed manuals (Accessories), contact an au shop or Customer Service Center.

List of Packaged Items

Before you start using the product, make sure that you have all the following packaged items with the product.



SHV32

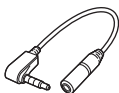

SHARP
TV antenna cable 01
(01SHHSA)*

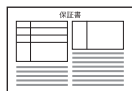

保証書 (Warranty)
(Japanese)

- 取扱説明書 (Basic Manual) (Japanese)
- ご利用にあたっての注意事項 (Notes on Usage) (Japanese)
- 設定ガイド (Setting Guide) (Japanese)

* Connection required for watching TV on the product. Do not misplace.

The following items are not included in the package.

- microSD memory card
- AC adapter
- Earphone
- microUSB cable

- Purchase a specified charger (sold separately).

- The battery is built into the product.
- Illustrations of cell phones in this manual are only for reference. They may look different from the actual product.

Operating Instructions

■ "Basic Manual" and "Setting Guide"

The "Basic Manual" (this manual) and "Setting Guide" available on the au homepage describe basic operations of major functions.

For detailed descriptions of various functions, refer to the "Instruction Manual application" (Japanese version) that can be used on the product or "Full Instruction Manual" (Japanese) available on the au homepage:

<http://www.au.kddi.com/english/support/manual/>

■ "Instruction Manual Application" (Japanese/English Version)

You can use the "Instruction Manual application" (Japanese version) on the product to check detailed operational procedures.

Also, you can activate intended functions from an explanation screen depending on the functions.

On the home screen, "Apps Sheet" → [取扱説明書] (Instruction Manual).

Also, you can use the "Instruction Manual application" (English version) on the product to check operational procedures.

On the home screen, "Apps Sheet" → [Basic Manual] after switching the display language to English (▶P.15).

- To use the application for the first time, you need to download and install it by following on-screen instructions.

Cell Phone Etiquette

■ Use of cell phones is not allowed in the following places!

- Do not listen to music or watch videos/TV while driving a car or riding a motorbike or bicycle. Use of a cell phone while driving a car or riding a motorbike is prohibited by law. (Use of a cell phone while riding a bicycle may be punishable by some regulations.) Be attentive to traffic around you while walking. Not being able to hear surroundings or looking only at the display may cause a traffic accident. Be careful especially at train crossings, on station platforms, and at crosswalks.
- Since using the product on airplanes is restricted, follow the instructions given by the respective airlines.

■ Be considerate of people around you

- Do not make calls in theaters, museums, libraries, and other similar places. Turn power off or turn on manner mode so as not to disturb others around you with your ringtones.
- Do not use the cell phone outside in town where you might hinder other pedestrians.
- Viewing a cell phone screen while walking is a serious hazard. Do not suddenly stop to talk on/operate the cell phone or do so while walking.
- Move to areas where you will not inconvenience others on bullet trains, in hotel lobbies, etc.
- Refrain from talking in a loud voice.
- Check whether sound from earphones, etc. is audible when near others on a train.
- Obtain the permission of other people before you take their photos with the cell phone's camera.
- Some people close to you in crowded places such as packed trains may be using a cardiac pacemaker. Turn on "Airplane mode" or turn the cell phone off in such places.
- Abide by the rules of hospitals and other medical institutions where it is forbidden to use or carry cell phones.

Using au Disaster Countermeasure Application

au Disaster Countermeasure is an application in which you can use Disaster Message Board, Emergency Rapid Mail (Earthquake Early Warning, Disaster and Evacuation Information, and Tsunami Warning), Disaster Voice Messaging Service and Disaster Information.

1 On the home screen, "Apps Sheet" → [au災害対策] (au Disaster Countermeasure).

The au Disaster Countermeasure menu is displayed.

When the terms of service screen or initial settings screen is displayed, check the contents and follow the on-screen instructions.

■ Using Disaster Message Board

Disaster Message Board is a service to enable customers in disaster areas to register their safety information via LTE NET when large-scale disasters, such as an earthquake whose Japan seismic scale is approximately 6-lower or more, occur. The registered safety information can be checked by customers using au phones, and also from other carriers' cell phones, PCs, etc. For details, refer to "Disaster Message Board Service" on the au homepage.

1 From the au Disaster Countermeasure menu, [災害用伝言板] (Disaster Message Board).

Follow the on-screen instructions for registration/confirmation.

- To register the safety information, an e-mail address (~ezweb.ne.jp) is required. Set the e-mail address in advance.
- Deletion of the safety information and configurations for Safety Notification Mail are not available during wireless LAN (Wi-Fi®) connection.
- The Company does not guarantee the quality of this service. The Company, regardless of the cause, shall not be liable for any problems related to registration of safety information due to the concentration of access to this service or equipment errors, any loss due to the damage, ruination, etc. of safety information or any loss arising from registered safety information.

■ Using Emergency Rapid Mail

Emergency Rapid Mail is a service to collectively deliver Earthquake Early Warning and Tsunami Warning provided by the Japan Meteorological Agency, and Disaster and Evacuation Information provided by the national government or the local governments to au phones in the specified areas.

- At the time of purchase, receiving setting of Emergency Rapid Mail (Earthquake Early Warning, and Disaster and Evacuation Information) is set to “受信する” (Receive). You can receive Tsunami Warning by setting 災害・避難情報 (Disaster and Evacuation Information).

When receiving Earthquake Early Warning, secure your safety and act composedly according to the surrounding situations.

When receiving Tsunami Warning, leave sea coasts immediately and evacuate to safe places such as hills and strongly-built tall buildings.

1 From the au Disaster Countermeasure menu, [緊急速報メール] (Emergency Rapid Mail).

The inbox is displayed.

Select a mail to check to display the details of the mail.

削除 (Delete)	Delete received mails.
設定 (Settings)	<p>緊急地震速報 (Earthquake Early Warning)</p> <ul style="list-style-type: none"> 受信設定 (Receive setting) Set whether to receive Earthquake Early Warning. <ul style="list-style-type: none"> Tap [受信する] (Receive)/[受信しない] (Not receive) → [OK]. 音量 (Volume) Set the volume of the receiving sound. マナー時の鳴動 (Linkage to the manner mode) Set whether to make the product ring at the time of reception while the manner mode is applied. バイブ (Vibrator) Set whether to activate the vibrator at the time of reception. 受信音／バイブ確認 (Check receiving sound/vibrator) Play back and check set volume/vibrator. <p>災害・避難情報 (Disaster and Evacuation Information)</p> <ul style="list-style-type: none"> 受信設定 (Receive setting) Set whether to receive Disaster and Evacuation Information and Tsunami Warnings. <ul style="list-style-type: none"> Tap [受信する] (Receive)/[受信しない] (Not receive) → [OK]. 音量 (Volume) Set the volume of the receiving sound. マナー時の鳴動 (Linkage to the manner mode) Set whether to make the product ring at the time of reception while the manner mode is applied. バイブ (Vibrator) Set whether to activate the vibrator at the time of reception. 受信音／バイブ確認 (Check receiving sound/vibrator) Play back and check set volume/vibrator.

- This service is available only in Japan (Not available overseas).
- Emergency Rapid Mail is free of both information charges and communication charges.
- Emergency Rapid Mail cannot be received while the power is turned off.
- Emergency Rapid Mail may not be received when you are in a place where the signal cannot be received (e.g. tunnels and basements) or the signal is weak, even within the service area.
- Emergency Rapid Mail which failed to be received will not be able to be received again.
- When you receive Emergency Rapid Mail, you will be notified by the dedicated alarm tone and the vibrator. The alarm tone cannot be changed.
 - * When you receive Earthquake Early Warning, you will be notified by the alarm tone, voice (“地震です” (Jishin-desu)) meaning that an earthquake has occurred and the vibrator.
- The alarm tone does not ring if Emergency Rapid Mail is received during a call.
- Information intended for the areas of other than your present location may be received.
- As for this service, the Company shall not be liable for any damage incurred on the users resulted from failure or delay of information delivery due to communication disturbance or system failure, contents of the information or other problems that are not supposed to be blamed on the Company.

- For details on Earthquake Early Warning and Tsunami Warning provided by the Japan Meteorological Agency, refer to the agency's homepage.
<http://www.jma.go.jp/jma/indexe.html>

Earthquake Early Warning

- Earthquake Early Warning notifies areas where a strong shaking (Japan seismic scale 4 or more) is expected when an earthquake whose maximum Japan seismic scale is predicted of 5-lower or more has been detected.
- This service detects an earthquake (P-wave, preliminary tremors) near the seismic center immediately after the earthquake occurs and automatically calculates its location, scale and predicted strength of the shaking. After that, you will be notified of the earthquake as soon as possible within a few seconds to dozens of seconds before a strong shaking from the earthquake (S-wave, principal shock) occurs.
- In the vicinity of the seismic center, a strong shaking may reach you before Earthquake Early Warning.
- The Earthquake Early Warning distribution system provided by this service is different from that provided by TV, radio and other communication media and thus the arriving time of Earthquake Early Warning may be different among those media.

Tsunami Warning

- Tsunami Warning notifies areas including target sea coasts of Major Tsunami Warning and Tsunami Warning provided by the Japan Meteorological Agency.

Disaster and Evacuation Information

- Disaster and Evacuation Information notifies information related to the safety of citizens, such as evacuation advisories, evacuation orders or various alarms delivered by the national government or the local governments.

Using Disaster Voice Messaging Service

Disaster Voice Messaging Service is a service to record voices with a smartphone and deliver them as a voice message to people to whom you want to deliver the information that you are safe when large-scale disasters occur.

1 From the au Disaster Countermeasure menu, [災害用音声お届けサービス] (Disaster Voice Messaging Service).

Follow the on-screen instructions.

- To use this service via Wi-Fi®, making initial settings via 4G (LTE/WiMAX 2+) networks is required.
- Voice messages can be recorded for up to 30 seconds.
- Voice messages can be exchanged among au phones as well as other carriers' cell phones and PHS devices.
- Voices may not be heard when the media sound volume is set to low.
- When no free space is left on the internal memory, voice messages may not be saved or played.
- Some cell phones cannot receive voice messages. For details, refer to the au homepage.

Using Disaster Information

You can check disaster information, histories of Disaster and Evacuation Information delivered by the local governments, etc.

1 From the au Disaster Countermeasure menu, [災害関連情報] (Disaster Information).

Select an item to check.

Illustrations and Descriptions in This Manual

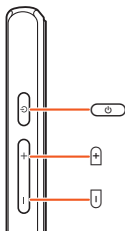

Note on Key Illustrations

In this manual, the key illustrations are simplified as shown below.



Description of Operations for Selecting Item/Icon/Key etc.

In this manual, operation procedures are described as below.

Description	Explanation
On the home screen, "Apps Sheet" → [Phone] → Enter "141" → [Call].	Slide/flick the Feel Home screen to switch to the Apps Sheet, and then tap "Phone". Continue by tapping "1", "4", and "1", and finally "CALL".
 (hold down for at least 2 seconds).	Hold  down for at least 2 seconds.

* Tapping is to select a key or icon displayed on the screen by lightly tapping it with your finger.

Notes on Illustrations/Screenshots

Screenshots and operations in this manual are based on the product with an au Nano IC Card 04 installed. Screenshots may differ from actual screen. Portions of the screen are sometimes omitted.

In this manual, part of the screen such as icons are omitted.

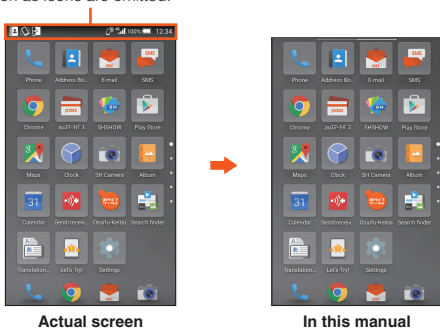

Actual screen

In this manual

- Explanations of this manual are based on the case when the color of the main unit is "Green" as an example.
- Explanations of this manual are based on the case when the product is held vertically. If you hold it horizontally, menu items/icons/on-screen keys etc. may be different.
- Descriptions in this manual are based on operation in Feel Home. Operations may be different if home applications have been changed (by using "Home applications", etc.).
- Menu items, layers and icons described in this manual may be different according to functions being used and conditions.
- In this manual, "microSD™ memory card (commercially available)", "microSDHC™ memory card (commercially available)" and "microSDXC™ memory card (commercially available)" are abbreviated as "microSD memory card" or "microSD".
- All of the indicated amounts exclude tax unless otherwise specified.

Names and Functions of Parts

Front/Left Side/Right Side

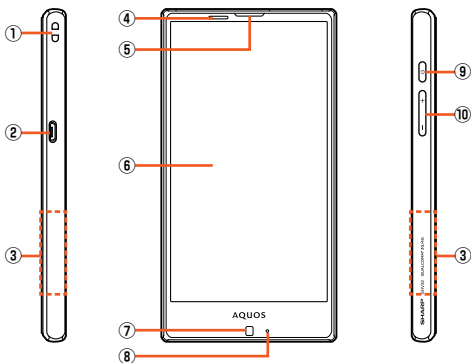

① Strap eyelet

② External connection jack

Use when connecting the common AC adapter 05 (sold separately), the microUSB cable 01 (sold separately), USB cable for peripherals (commercially available), etc. to the product.

When you connect the common AC adapter 05 (sold separately), the microUSB cable 01 (sold separately), etc. to the product, some applications may not function properly since the geomagnetic sensor is affected by the magnetism of connected devices. Use the product after removing the cable.

③ Grip sensor

By setting "Grip magic", holding the product (touch the sensor areas on both sides at the same time) turns the screen on or minimizes the volume and makes the product vibrate when a call is arriving or for an incoming call or notification.

- Even if you release your hand from the sensor areas, the screen is not turned off immediately.

④ Proximity sensor/Light sensor

Proximity sensor prevents inadvertent operations of the touch panel during a call.

Light sensor detects the ambient brightness and adjusts the brightness of display.

⑤ Earpiece (Receiver) / Microphone

⑥ Display (Touch panel)

⑦ In camera lens

⑧ Charging/Incoming indicator

⑨ Power key

Turn the screen on/off.

Hold it down to turn on/off the power, set the manner mode, etc.

⑩ Volume up/down key

Adjust the volume.

Hold down  on the Welcome Sheet (Lock Screen) to turn on the mobile light.

Hold down  on the home screen or Welcome Sheet (Lock Screen) to set/disable the manner mode.

■ Back/Top and Bottom

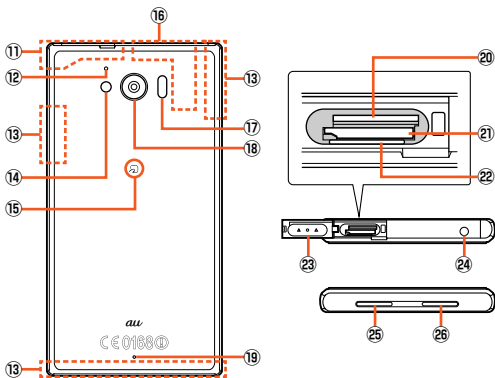

① **Internal antenna**

② **Microphone**

③ **Wi-Fi®/Bluetooth®/GPS antennas**

④ **Mobile light**

⑤ **↻ mark**

Hold it over a reader/writer when using Osaifu-Keitai®/NFC.

⑥ **Internal TV antenna**

⑦ **Infrared port**

⑧ **Out camera lens**

⑨ **Air vent**

For maintaining performance.

⑩ **microSD memory card slot**

⑪ **au Nano IC Card 04 tray slot**

⑫ **IMEI tray**

Allows you to confirm the product's IMEI.

⑬ **au Nano IC Card 04/microSD memory card cover**

⑭ **Earphone/Microphone jack**

Connect a SHARP TV antenna cable 01 here to use TV (viewing/recording) (▶ P.8).

⑮ **Mouthpiece (Microphone)**

⑯ **Speaker**

○ The back cover of the product cannot be removed. Removing it forcibly may cause damage or a fault.

○ The battery is built into the product, and cannot be removed by the customer. To force the power off, refer to "Turning the Power Off Forcibly" (▶ P.14).

Proximity sensor/light sensor, earpiece (receiver), mouthpiece (microphone), speaker, microphone, air vent

○ Placing stickers, etc. over proximity sensor/light sensor may prevent the product from operating properly.

○ Covering earpiece (receiver), mouthpiece (microphone), speaker, microphone, or air vent with fingers, etc. may hinder product performance.

Grip sensor

○ The sensor may not work properly and prevent you from using Grip magic in the following cases. This may also cause malfunction.

- Operation with gloved hands
- Operation while the product is equipped with a case, cover, etc.*
- Operation while the product is wet
- Operation while a metallic object touches the sensor
- When you put a case or cover on/off the product with Grip magic set to "ON".

* Depending on the case or cover, you may be able to use Grip sensor with the product equipped with it. Set "Putting cover setting" to "Covered" after equipping the product with the case or cover.

Internal TV antenna, internal antenna, Wi-Fi®/Bluetooth®/GPS antennas

○ Antennas are built into the product. Do not cover with hand during calls or data communication. Doing so may affect call/communication quality.

IMEI tray

- An IMEI (international mobile station equipment identity) is a special identification code assigned to each phone. You can pull the IMEI tray out to confirm the IMEI of the product.
- The IMEI is information required when requesting servicing or repairs.
- The IMEI tray cannot be removed from the main unit. Take care not to apply force when handling.
- You can also operate the product to confirm the IMEI.
On the home screen, "Apps Sheet" → [Settings] → [About phone] → [Status] and confirm the IMEI field.

Connecting a SHARP TV Antenna Cable 01

- 1** Insert the plug of a SHARP TV antenna cable 01 in the Earphone/Microphone jack.

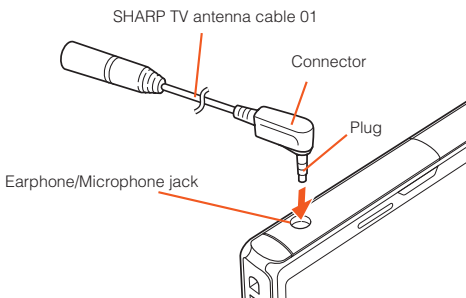

Using the au Nano IC Card 04

au Nano IC Card 04

The au Nano IC Card 04 records your personal information such as phone numbers.
Any au IC card other than au Nano IC Card 04 cannot be used with the product.

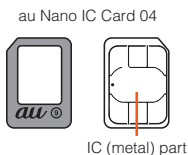

- Make sure to unplug the microUSB plug of the common AC adapter 05 (sold separately) etc. from the product when attaching or removing the au Nano IC Card 04.

Attaching the au Nano IC Card 04

Before attaching the au Nano IC Card 04, turn the product off and remove the microSD memory card.

- 1** Open the au Nano IC Card 04/microSD memory card cover.
- 2** Slowly pull the au Nano IC Card 04 tray straight out by hooking a finger on it.

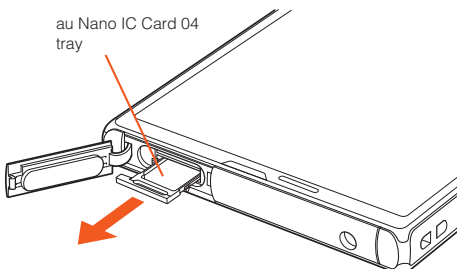

- 3** Put the au Nano IC Card 04 on the au Nano IC Card 04 tray. Make sure the notches on the au Nano IC Card 04 and au Nano IC Card 04 tray face the proper orientation and put the card slowly on the tray.

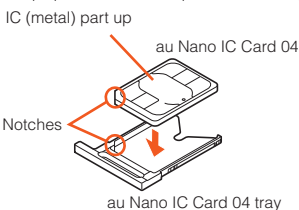

- 4** Slowly insert the au Nano IC Card 04 tray into the au Nano IC Card 04 tray slot, taking care not to let the tray be caught on the metal parts on both sides of the slot.

Confirm the position of the au Nano IC Card 04 tray slot and the orientation of the au Nano IC Card 04 tray carefully, and insert the tray all the way into the slot in the direction of the arrow. Inserting the tray forcibly may damage the tray.

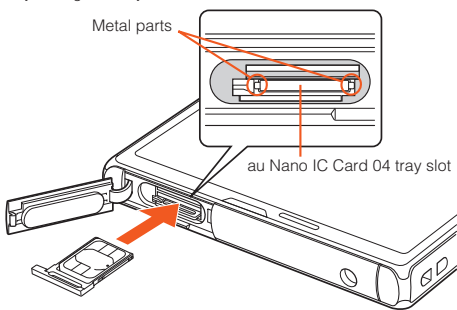

- 5** Close the au Nano IC Card 04/microSD memory card cover.

- Inserting the au Nano IC Card 04 tray not deeply enough may prevent the product from functioning properly.
- Take care not to lose or damage the removed au Nano IC Card 04 tray.

Removing the au Nano IC Card 04

Before removing the au Nano IC Card 04, turn the product off and remove the microSD memory card.

- 1** Open the au Nano IC Card 04/microSD memory card cover.
- 2** Slowly pull the au Nano IC Card 04 tray straight out by hooking a finger on it.

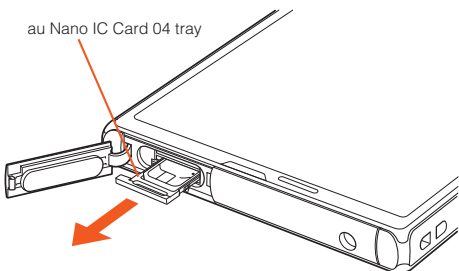

- 3** Remove the au Nano IC Card 04 from the au Nano IC Card 04 tray.
- 4** Slowly insert the au Nano IC Card 04 tray into the au Nano IC Card 04 tray slot, taking care not to let the tray be caught on the metal parts on both sides of the slot.

Confirm the position of the au Nano IC Card 04 tray slot and the orientation of the au Nano IC Card 04 tray carefully, and insert the tray all the way into the slot in the direction of the arrow. Inserting the tray forcibly may damage the tray.

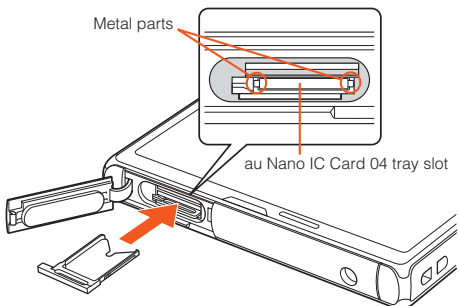

- 5** Close the au Nano IC Card 04/microSD memory card cover.

Using a microSD Memory Card

Attaching a microSD Memory Card

1 Open the au Nano IC Card 04/microSD memory card cover.

2 Slowly insert the microSD memory card into the microSD memory card slot.

Confirm the orientation for inserting, then insert in the direction of the arrow until it clicks and is locked.

Releasing the microSD memory card before it is locked may cause it to pop out.

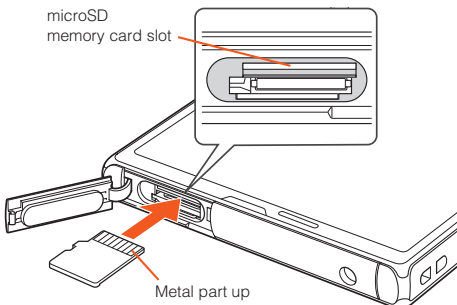

3 Close the au Nano IC Card 04/microSD memory card cover.

- Make sure that the top/bottom and front/rear of the microSD memory card are facing correctly. Trying to force a wrongly oriented card into the slot could make it impossible to remove the card or result in damage.
- Do not touch the terminal part of a microSD memory card.

Removing the microSD Memory Card

Be sure to unmount microSD card before removing. Not doing so may corrupt data or card may no longer operate properly.

1 Open the au Nano IC Card 04/microSD memory card cover.

2 Slowly push the microSD memory card in all the way.

After it clicks, let the microSD memory card come back out a little without releasing it. Releasing the card when it is pushed deeply into the slot may cause it to pop out.

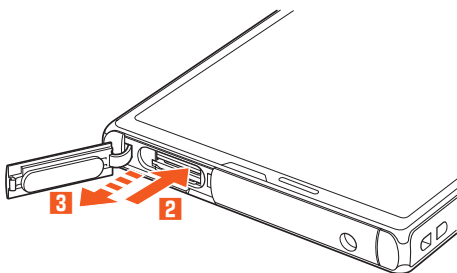

3 Slowly pull the microSD memory card straight out.

4 Close the au Nano IC Card 04/microSD memory card cover.

- Do not remove the microSD memory card forcefully. Doing so may result in damage or data loss.
- The microSD memory card may become warm after a long time use, but this is not a fault.

Charging

Charging

When you purchase the product, the internal battery is not fully charged. Be sure to charge the internal battery before use.

- If the performance of the battery does not recover (e.g. the usable time after each charge has become extremely short), the internal battery may be at the end of service life. On the home screen, "Apps Sheet" → [Settings] → [About phone] → [Status] → [Battery status] to check the charging performance of the internal battery.
- While charging, the charging/incoming indicator illuminates in red, and the battery icon is displayed with ⚡ superimposed. When the battery is charged to approximately 95%, the charging/incoming indicator illuminates in green. When charging is finished, the charging/incoming indicator goes out.

- The product may become warm while charging, but this is normal.
- Depending on the operation procedure and usage environment, the temperature inside the product may get high and the product may even get heated. In such case, charging may stop for security reasons.
- Charging the internal battery while using the camera function etc. may lengthen the charging time.
- If you perform various operations with a specified charger (sold separately) connected to the product, charging/discharging may take place repeatedly in a short time. Frequently charging the internal battery shortens its service life.
- If you charge the internal battery when the battery has run out, the charging/incoming indicator may not illuminate soon. However, charging is in progress.
- If the charging/incoming indicator flashes in red, force the power off (▶P.14) and turn the product on again. If the indicator continues to flash, stop charging the internal battery and contact an au shop or the Keitai Guarantee Service Center.
- If you stop charging while the charging/incoming indicator still illuminates during charging, the cell phone may be left not fully charged even if  is displayed on it. In such case, the usage times shorten.

Charging with the Specified AC Adapter (Sold Separately)/Specified DC Adapter (Sold Separately)

The followings are the explanation of how to connect the common AC adapter 05 (sold separately)/common DC adapter 03 (sold separately) to charge. For details on the specified AC adapter (sold separately)/specified DC adapter (sold separately), refer to "Introduction of Peripheral Devices" (▶P.20).

- 1 Confirm the direction of the microUSB plug of the common AC adapter 05 (sold separately)/common DC adapter 03 (sold separately) and insert it in the direction of the arrow to the external connection jack of the product.**

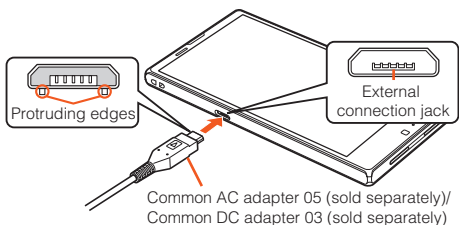

- 2** Plug the common AC adapter 05 (sold separately) power plug into a 100 V AC power outlet/Plug the common DC adapter 03 (sold separately) plug into a cigarette lighter socket.

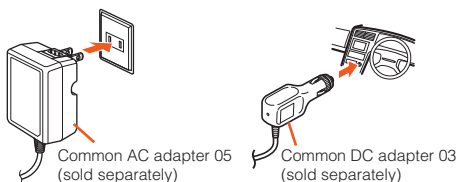

- 3** When charging is finished, pull the microUSB plug of the common AC adapter 05 (sold separately)/common DC adapter 03 (sold separately) straight out from the external connection jack of the product.

- 4** Unplug the common AC adapter 05 (sold separately) power plug from the power outlet/Unplug the common DC adapter 03 (sold separately) plug from the cigarette lighter socket.

⊙ Although you can charge the internal battery while the power is turned on, charging time lengthens.

Charging with a PC

The followings are the explanation of how to charge the internal battery by connecting the product to a USB port of a PC through which the battery can be charged.

- 1** Connect the microUSB cable 01 (sold separately) to a USB port of a PC after the PC is activated completely.

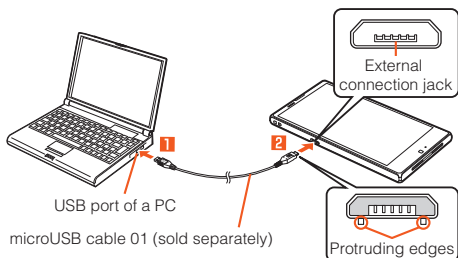

- 2** Connect the microUSB cable 01 (sold separately) to the product.

- ⊙ If you use the microUSB cable to charge the internal battery, it may take the internal battery longer to be fully charged than if you use the specified AC adapter (sold separately).
- ⊙ Turn the protruding side of the microUSB plug down and insert the microUSB plug to the external connection jack of the product straightly. Inserting the microUSB plug in the wrong direction may result in damage to the external connection jack of the product.
- ⊙ If you charge the internal battery when the battery has run out, the charging/incoming indicator may not illuminate. In such case, use the specified AC adapter (sold separately) for charging.

Turning the Power On/Off

Turning the Power On

- 1  (hold down for at least 2 seconds) while the product is turned off.

⦿ The initial setting of the touch panel will be executed until "AQUOS" disappears from the screen after the power is turned on. Do not touch the screen, otherwise touch panel operations may not be performed properly.

Turning the Power Off

- 1  (hold down for at least 2 seconds).
- 2 [Power off] → [OK].

Restarting the Product

You can restart the product after turning it off.

- 1  (hold down for at least 2 seconds).
- 2 [Reboot] → [OK].

Turning the Power Off Forcibly

You can force the product to turn off if the screen freezes or you are unable to turn the product off.



- 1  (hold down for at least 8 seconds).
Release your finger after the product vibrates to turn the power off.

⦿ If the power is turned off forcibly, unsaved data will be deleted. Do not turn the power off forcibly unless you cannot operate the product.

Booting in Safe Mode

Turn the product off then boot it in a state close to that at time of purchase. If operation of the product is unstable, it may be due to applications installed after purchasing the product. If symptoms improve when booted in safe mode, uninstalling the applications you installed may remedy symptoms.

- 1  (hold down for at least 2 seconds).
- 2 Long touch "Power off" → [OK].
"Safe mode" is displayed at the bottom of the screen when the product is booted in safe mode.
To end safe mode, reboot the product.

⦿ When the product is turned off, you can boot it in safe mode by  (hold down for at least 2 seconds) to turn it on, and then holding down  until the Welcome Sheet (Lock Screen) is displayed after the SHARP logo appears.

- ⦿ It is recommended that you back up your data on the product before booting in safe mode.
- ⦿ Widgets that you yourself created may be deleted.
- ⦿ Safe mode is not a normal state for the product to be booted in. End safe mode before normal use.

Turning the Screen On/Off

If you press  or no operation is made for a specified time, the screen is turned off.

Turning the Screen On

- 1  while the screen is turned off.

⦿ When you put the product in your pocket, bag, etc., turn the screen off. Putting the product in while the screen is turned on may cause inadvertent operations.

Welcome Sheet (Lock Screen)

The Welcome Sheet (Lock Screen) is displayed if you turn the screen on.



《Welcome Sheet (Lock Screen)》

① Wallpaper

② Address Book Plus

Display information registered in the address book. Frequently called contacts such as favorites can be displayed in the notifications area.

③ Notifications area

Notifications for missed calls, new e-mail/SMS, etc. appear as a pop-up. Double-tap notification for corresponding screen.

Drag notifications area down for list of notifications. Tap notifications for corresponding screen.

④ Owner info

Tap to display texts according to items set for "Owner info" in "Lock & Security".

⑤ Shortcuts

Slide "⋮" to top of screen for shortcuts.

⑥ Info area

Flick to the left/right to switch between information from emopa, weather, and stock prices.

- If "エモパ- (emopa)" is set to "ON", a variety of information from emopa is displayed. Double-tap information or long touch → [確認] (Check) to display related sites, etc.
- If initial settings for emopa have not been made, "エモパ-を使ってみませんか? (Try using emopa?)" is displayed. Double-tap to make emopa settings.

⑦ Screen lock

Slide "🔒" to top of screen to unlock the screen.

- If a password, etc. is set in "Screen lock", it is displayed as "🔒".

⑧ Activate camera

Slide "📷" to top of screen to activate the SH camera.

Switching the Display Language to English

You can switch the display language for function names and other items to English.

1 On the home screen, "Apps Sheet"

2 [設定] (Settings).

3 [言語と文字入力] (Language & input).

4 [言語(Language)を選択] (Select language).

5 [English].

Using the Feel Home

Feel Home is a home screen that consists of the Desktop Sheet, the Apps Sheet, and the dock.

You can tap widgets/shortcuts on the Desktop Sheet and icons on the Apps Sheet to use functions. You can also register shortcuts for favorite apps in the dock.

- Slide/flick the home screen to the left/right to switch between the Desktop and Apps Sheets.

Switching sheets



■ Viewing the Feel Home

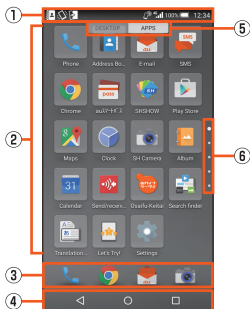

① **Status bar**

② **Desktop Sheet/Apps Sheet**

③ **Dock**

You can register a shortcut for the application in the dock, to start quickly.

④ **Navigation Bar**

⑤ **Guide Tab**

When you switch the Desktop Sheet/Apps Sheet, the sheet name will be displayed.

⑥ **Page Indicator**

The current position of the Desktop Sheet/Apps Sheet will be displayed.















- Slide/flick the Desktop and Apps Sheets up/down to switch pages.
- Slide “◀”, “○”, or “▶” up and drag left or right until “○” is appears and release your finger to search the internal memory and websites for information. Applications can be selected to activate them. Also, slide “◀”, “○”, or “▶” up and drag left or right until “🔒” or “🔓” appears and release your finger to use screen shrink mode.

Using the Status Bar























Icons

The notification icons to notify you of a missed call, a new mail message, a running operation, etc. are displayed on the left side of the status bar, while the status icons to show the status of the product are on the right side.

Main Notification Icons

Icon	Description
	Missed call
	New E-mail message
	New SMS message
	New PC-mail message
	New Gmail™ message
	Making a call, talking, receiving a call
	Talking in high quality sound with a model supporting VoLTE provided by au.
	Call on hold
	Answering memo
	Available space on the internal memory being run out
	Update available
	Installation completion of application
	Software update available
	Icons collected

Main Status Icons

Icon	Description
	Time
	Battery level  ~  : Battery level display  : No battery • While charging, the battery icon is displayed with  superimposed. • Percentage of the remaining battery level appears on the left side of the battery icon.
	Airplane mode set
	Signal strength (Receiving electric field)  ~  : Level display  : Out of service area • The icon indicating network is displayed at the upper left.  : LTE/WiMAX 2+ available* • During a communication, the icon is displayed with  superimposed.
	Roaming
	Manner mode status  : Standard manner mode  : Silent manner mode
	During a call using hands-free
	Microphone set to "Mute" during a call
	Answering memo set  : No Answering memo  : Answering memo (one to nine entries)  : Answering memo (ten entries)

* Both "LTE" and "WiMAX 2+" networks are available. "4G" is displayed for either network. Your cell phone connects to the network deemed to be the least congested according to the network traffic.

Using the Notification/Status Panel

In the notification/status panel, you can check the details on notification icons and status icons or activate an application corresponding to the icon. You can also set the manner mode, VeilView, etc.

1 Slide the status bar down.

Viewing the Notification/Status Panel

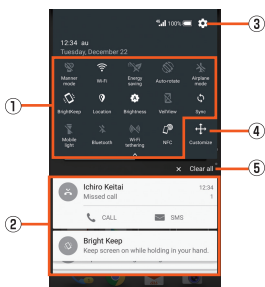

《Notification/Status panel》

① Function buttons

Switch settings of the frequently used function by one touch. Slide the displayed area up or down or tap the top of the screen to shrink/enlarge the function button area.

② Notification

Check the status of the product and notifications as well as make settings for Address Book Plus. Tap notifications to activate corresponding application.

- Flick notifications to the left or right to delete them. Some notifications cannot be deleted.
- Slide the displayed area up to view hidden notifications.
- Slide notifications up or down using two fingers or pinch/widen your fingers to switch between detailed and simple views.
- Long touch notification → tap [ⓘ] to make notification settings for the application.

③ Settings

Tap it to make various settings for the product.

④ Customize

Change or rearrange the displayed function buttons.

⑤ Clear all

Tap it to clear all the notifications. You may not be able to delete a notification depending on the notification.

- Slide the notification/status panel from the bottom to the top to hide it.
- Slide the status bar down using two fingers to display the notification/status panel with the function button area expanded.

Switching Input Methods

You can switch input methods for character entry.

• Following operation explanations use "Japanese - iWnn IME - SH edition".

- 1 On the home screen, "Apps Sheet" → [Settings]
- 2 [Language & input] → [Current selected keyboard]
- 3 [CHOOSE KEYBOARDS]
- 4 [Google Keyboard]/[S-Shoin]/[Google voice typing]

Switching Software Keyboards

- 1 On the character entry screen, [⚙️] → [Input UI] → [QWERTY keyboard]/[12 keyboard].

Checking Your Own Phone Number

- 1 On the home screen, "Apps Sheet" → [Settings] → [Profile].

Setting the Manner Mode

- 1 On the home screen, "Apps Sheet" → [Settings] → [Sound/ notification] → [Mode settings].
- 2 Select a mode.

Setting Airplane mode

- 1 On the home screen, "Apps Sheet" → [Settings] → [More] → [Airplane mode].

Introduction of Peripheral Devices

- au Carrying Case F Black (0105FCA) (sold separately)
- au Carrying Case G Black (0106FCA) (sold separately)
- au Carrying Case H Black (0107FCA) (sold separately)

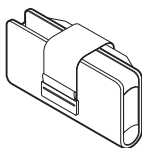

au Carrying Case F Black

- Common AC Adapter 03 (0301PQA) (sold separately)
- Common AC Adapter 05 (0501PWA) (sold separately)
- Common AC Adapter 03 Navy (0301PBA) (sold separately)
- Common AC Adapter 03 Green (0301PGA) (sold separately)
- Common AC Adapter 03 Pink (0301PPA) (sold separately)
- Common AC Adapter 03 Blue (0301PLA) (sold separately)
- AC Adapter JUPITRIS (White) (L02P001W) (sold separately)
- AC Adapter JUPITRIS (Red) (L02P001R) (sold separately)
- AC Adapter JUPITRIS (Blue) (L02P001L) (sold separately)
- AC Adapter JUPITRIS (Pink) (L02P001P) (sold separately)
- AC Adapter JUPITRIS (Champagne) (L02P001N) (sold separately)

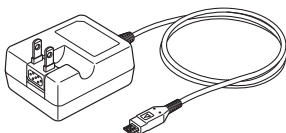

Common AC adapter 05

- Illustrations and forms may not match depending on the AC adapter you use.

- Common DC adapter 03 (0301PEA) (sold separately)

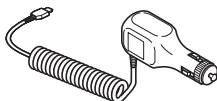





- Portable charger 02 (0301PFA) (sold separately)
- microUSB cable 01 (0301HVA) (sold separately)
- microUSB cable 01 Navy (0301HBA) (sold separately)
- microUSB cable 01 Green (0301HGA) (sold separately)
- microUSB cable 01 Pink (0301HPA) (sold separately)
- microUSB cable 01 Blue (0301HLA) (sold separately)
- SHARP microUSB conversion cable 01 for TV antenna input (SHL23HKA) (sold separately)
- SHARP TV antenna conversion and charging cable 02 (02SHHKA) (sold separately)
- SHARP TV antenna cable 01 (01SHHSA) (sold separately)

- It may not be possible to adequately charge the product with the portable charger 02 (sold separately).
- For the latest information about available peripheral devices, check the au homepage (<http://www.au.kddi.com/english/>) or contact Customer Service Center.
- The product does not support ASYNC/Fax transmission.
- The above-mentioned peripheral devices can be purchased from au Online Shop. You may not be able to purchase one depending on the stock status.
<http://auonlineshop.kddi.com/>

Troubleshooting

Before you assume that the product is malfunctioning, check the following:

Trouble	Detail
Battery usage time is short.	<ul style="list-style-type: none"> • Make sure you do not often use the product in places where  (out of service area) is displayed. (▶P.17) • Make sure the internal battery does not approach the end of its service life. Check the battery status. (▶P.12) • Is the internal battery charged enough? (▶P.12) • Suspend the functions not being used. (▶P.18)
Cannot make calls.	<ul style="list-style-type: none"> • Is an au Nano IC Card 04 inserted? (▶P.8) • Make sure "Airplane mode" is not set. (▶P.19) • Is the power turned on? (▶P.14)
Cannot receive calls.	<ul style="list-style-type: none"> • Is reception good enough? (▶P.17) • Is the product within the service area? (▶P.17) • Make sure "Airplane mode" is not set. (▶P.19) • Is the power turned on? (▶P.14) • Is an au Nano IC Card 04 inserted? (▶P.8)
Cannot hear the other party.	<ul style="list-style-type: none"> • Make sure you are not covering the earpiece with your ear. Place the earpiece over your earhole.
Cannot recognize a microSD memory card/Cannot find target data.	<ul style="list-style-type: none"> • Is a microSD memory card inserted properly? (▶P.11) • Make sure data is not saved on the internal memory. Data can be saved on the internal memory besides a microSD memory card.
Cannot operate the keys/touch panel.	<ul style="list-style-type: none"> • Turn off the power and then turn it on. • Is the power turned on? (▶P.14)
Cannot charge the battery.	<ul style="list-style-type: none"> • Is the power plug of the specified charger (sold separately) securely plugged into an outlet or a cigarette lighter socket? (▶P.12)
Cannot turn on the power.	<ul style="list-style-type: none"> • Is the internal battery charged? (▶P.12) • Did you hold  down? (▶P.14)
Cannot operate/The screen does not respond/Cannot turn off the power.	<ul style="list-style-type: none"> • You can force the power off by holding down  for at least 8 seconds and releasing your finger after the product vibrates. Turn the product on again after a while. (▶P.14)
Cannot operate the touch panel as intended.	<ul style="list-style-type: none"> • Make sure you are not operating with hands wearing gloves etc. • Make sure you are not operating with the tip of a fingernail or with foreign object between the screen and your fingers. • Restart the product. (▶P.14)
Screen response is slow when you tap on the screen/press the keys.	<ul style="list-style-type: none"> • Screen response may be slowed down when a large amount of data is stored in the product or being transmitted between the internal memory and a microSD memory card.
An error of the au IC card (UIM) or a message indicating that the card is not inserted is displayed.	<ul style="list-style-type: none"> • Is an au Nano IC Card 04 inserted? (▶P.8)
The power is turned off automatically.	<ul style="list-style-type: none"> • Make sure the battery has not run out. (▶P.12)
The power is turned off while the wake-up logo is displayed.	<ul style="list-style-type: none"> • Make sure the battery has not run out. (▶P.12)
 (out of service area icon) is displayed.	<ul style="list-style-type: none"> • Is reception good enough? (▶P.17) • Is the product within the service area? (▶P.17) • Is your hand off the area around the internal antenna? (▶P.7) • Is an au Nano IC Card 04 inserted? (▶P.8)
The display or charging/incoming indicator illuminates/flashes, but the ringtone does not ring.	<ul style="list-style-type: none"> • Make sure the manner mode is not set. (▶P.19)

Trouble	Detail
A message indicating that charging is necessary is displayed.	• The battery is almost empty. (▶P.12)
Calls are automatically answered.	• Make sure the manner mode is not set. (▶P.19)
When making a call, a beeping sound is heard from the earpiece and a connection cannot be established.	<ul style="list-style-type: none"> • Is reception good enough? (▶P.17) • Is the product within the service area? (▶P.17) • The wireless line is busy or the other party is on another line. Try again later.

If symptoms do not improve after checking each of the above, information is provided through au Customer Support on the au homepage below.

<http://www.au.kddi.com/english/support/>

Updating Software

The product supports the software update.

The software update function can also be used for operating system updates.

An operating system update is a software update which also includes updating of the product's operating system.

1 On the home screen, "Apps Sheet" → [Settings] → [About phone] → [Software update].

When you activate this for the first time, the confirmation screen for Privacy policy is displayed. Check the contents and tap "OK".

Software update	Check whether software update is necessary or not. The confirmation starts when you tap "Yes". When it is necessary, you can download data for software update.
Auto-check settings	Set whether to regularly check presence of data for software update available.

Notes on Software Update

- You are charged for data communication when connecting to the Internet from the product by using packet communication. Large-volume data communication occurs in particular for operating system updates. Use of Wi-Fi® is recommended.
- When software update is necessary, you will be informed on au homepage, etc. For details, contact an au shop or Customer Service Center (call toll-free 157). In addition, users of the SHV32 will receive a notice from au, when software update is necessary to improve the functionality of the SHV32.
- It is recommended to back up your data before updating software.
- If the software update is performed, the product will restart before and after the update.
- If the software update has failed or stopped, perform the same procedures again.
- If the software update fails, it may become impossible to operate the product. If this happens, bring it to an au shop or PiPit (not accepted by some shops).
- Charge the battery sufficiently before starting update. If the battery level is insufficient or the battery runs out during the update, the software update will fail.
- Check out the signal reception status. The software update may fail if the product is in a place with bad signal reception status.
- Various data registered on the product (address books, mails, still pictures, music data, etc.) and information of settings will not be changed even after software is updated. However, note that data may not be protected depending on the state of the product (fault, damage, getting wet with water, etc.).
- After software is updated, the download of next update software may automatically start (consecutive update).
- During international roaming, the software update function can only be used with a Wi-Fi® connection. As this function cannot be used without a Wi-Fi® connection, be sure to first connect via Wi-Fi® before updating software.
- After you have updated the operating system, you cannot return it to the previous version.

Do not conduct the following operations during the software update

- Do not move during software update.

The following operations are not available during the software update

- Operations are not available during software update. Making a call to 110 (Police), 119 (Fire and Ambulance), 118 (Regional Coast Guard Headquarters) or 157 (Customer Service Center) is not available either. Also, the alarm etc. does not function.

After-Sales Service

When Asking for Repair

For repair, contact Keitai Guarantee Service Center.

During the warranty period	Repairs will be done based on the Company's terms of services of the free-of-charge repair warranty described on the warranty card.
Outside the warranty period	We shall repair the product for a charge as requested by the customer if repair renders it usable.

- Before handing in the product for repair, make a backup of the contents of memory since they may disappear during repair. Note that the Company shall not be liable for any damages and loss of income should the contents of memory be altered or lost.
- Recycled parts that meet the Company's quality standards are sometimes used for repair.
- au cell phones collected by Replacement cell phone delivery service which you used before are recycled to cell phones for replacement after repairs. Also parts replaced by au after-sales service are collected and recycled by the Company. They are not returned to customers.
- Instances where the product has been changed, modified, or analyzed (including software modification or analysis (including rooting, etc.) reverse-engineered, reverse-compiled, or reverse-assembled) or has been repaired at a location other than an authorized repair location designated by the company may not be covered by warranty or may prevent the product from being accepted for repairs.

Performance Parts for Repair

The Company retains performance parts for repair of the SHV32 main unit and its peripheral devices for 4 years after discontinuation of production.

"Performance parts for repair" refers to parts required for maintaining the functions of the product.

Warranty Card

At the store of purchase, thoroughly check and read the name of the retailer, date of purchase and other necessary details filled in on the warranty card, and be sure to keep it in a safe place.

Keitai Guarantee Service Plus LTE

An after-sales service membership program on a monthly basis called "Keitai Guarantee Service Plus LTE" (monthly fee: 380 yen, tax excluded) is available for using your au cell phone for a long time without worries.

This service expands coverage for many troubles including malfunction, theft and loss. For details of this service, check on the au homepage or contact Keitai Guarantee Service Center.

- You can apply for membership only at the time of purchasing your au cell phone.
- Once you cancel the membership, you cannot reapply for it until you purchase an au cell phone next time.
- Note that when changing the model or purchasing an extra cell phone, this service only covers the most recently purchased au cell phone.
- When an au cell phone is handed over to you or someone else, the "Keitai Guarantee Service Plus LTE" membership is also handed over to the successor of the cell phone.
- When you get a new au cell phone by changing the model, purchasing an extra cell phone, etc., the "Keitai Guarantee Service Plus" or "Keitai Guarantee Service Plus LTE" membership for the old au cell phone is automatically canceled.
- Service contents are subject to change without notice.

au Nano IC Card 04

The au Nano IC Card 04 is lent to you by au. In case of loss or damage, the card will be replaced at your expense. When malfunction is suspected, or in case of theft or loss, contact an au shop or PiPit.

■ After-Sales Service

If you are unsure about anything regarding after-sales service, contact the following service counter.

Customer Service Center (service cancelation procedure in case of loss or theft)

From a fixed-line phone,  0077-7-113 (toll free)
 From an au cell phone, **113** without area code (toll free)
 Business hours: 24 hours (7 days a week)

Keitai Guarantee Service Center (for loss, theft or damage)

From a fixed-line phone/an au cell phone,
 0120-925-919 (toll free)
 Business hours 9:00 to 21:00 (7 days a week)

Servicing requests online (24 hours)

* From PCs and smartphones only

https://cs.kddi.com/support/n_login.html

- Applications for servicing can be made via the Internet for "damage", "water seepage", "theft", or "loss". Naturally-occurring malfunction (power does not turn on, the screen is frozen, etc. due to causes other than damage or water seepage) require consultation by telephone.
- Applications via the Internet require that you provide your e-mail address.

■ au After-Sales Service Information

Service contents	Keitai Guarantee Service Plus LTE member	Non-Keitai Guarantee Service Plus LTE member
Replacement cell phone delivery service (spontaneous failure: 1st year)	Free	N/A
Replacement cell phone delivery service (spontaneous failure: 2nd year and later)	Customer charge 1st: 5,000 yen 2nd: 8,000 yen	N/A
Replacement cell phone delivery service (partial damage, water soak, irreparable damage, theft and loss)	Customer charge 1st: 5,000 yen 2nd: 8,000 yen	N/A
Holding over and repair (spontaneous failure: 1st year)	Free	Free
Holding over and repair (spontaneous failure: 2nd year and later)	Free (three-year warranty)	Actual cost
Holding over and repair (partial damage)	Customer charge Upper limit: 5,000 yen	Actual cost
Holding over and repair (water soak and irreparable damage)	Customer charge 10,000 yen	Actual cost
Holding over and repair (theft and loss)	N/A	N/A (By model replacement)

* Charge amounts are all tax excluded.

Replacement cell phone delivery service

- When you have trouble with your au cell phone, you can have a cell phone for replacement (same model and color as your old one) delivered to any destination that you specify by calling us. Please return your old faulty au cell phone within 14 days after the cell phone for replacement is delivered to you.
- You can use this service up to twice within one year starting from the day when you first use this service. If you have not used this service over the past one year at the time of your application for this service, the application will be regarded as your first time. If you have, the application will be regarded as your second time.

* For details, check on the au homepage.

Holding over and repair

- Damages and malfunctions intentionally caused by the customer as well as those due to modification (e.g. disassembly, change of parts, painting, etc.) by the customer are not covered by this service.
- You cannot receive a refund for replacement of the outer casing due to stains, scratches, paint removal, etc. on the outer casing.

SIM-Unlocking the Product

This product can be SIM-unlocked. SIM-unlocking the product allows other-carrier SIM cards to be used with it.

- Requests can be made for SIM-unlocking on the au homepage or at an au shop.
- Some services, functions, etc. may have restrictions when an other-carrier SIM card is used. The Company does not guarantee operation whatsoever.
- Setting after SIM-unlocking the product: on the home screen, "Apps Sheet" → [Settings] → [About phone] → [Status] → [SIM card status].
- For details, refer to the au homepage.

Main Specifications

■ Main Unit (SHV32)

Display	Approx. 5.0 inches, approx. 16.77 million colors, IGZO, 1,920×1,080 (FHD)
Weight	Approx. 134 g (including the internal battery)
Size (W×H×D)	Approx. 70 mm×132 mm×9.6 mm (thickest part approx. 9.9 mm)
Memory (built-in)	ROM: Approx. 32 GB RAM: Approx. 3 GB
Continuous talk time (in Japan)	Approx. 1,200 min.
Continuous talk time (overseas (GSM))	Approx. 600 min.
Continuous standby time (in Japan)	Approx. 380 hours
Continuous standby time (overseas (GSM))	Approx. 400 hours
Continuous tethering time	Approx. 410 min.
Maximum Wi-Fi® tethered connections	10 devices
Charging time	Common AC adapter 05 (sold separately): Approx. 130 min. Common DC adapter 03 (sold separately): Approx. 380 min.
Full Seg continuous watching time* ¹	Approx. 4 hours and 40 min.
1Seg continuous watching time* ¹	Approx. 6 hours and 30 min.
Camera device	Out camera CMOS image sensor In camera CMOS image sensor
Effective pixels	Out camera Approx. 13.10 million pixels In camera Approx. 2.10 million pixels
Bluetooth® function	Communication method: Bluetooth® Standard Ver.4.1 Output: Bluetooth® Standard Power Class 1 Communication distance* ² : Within 10 m with no obstacles in the range Compatible Bluetooth® profiles* ³ : HSP, HFP, A2DP, AVRCP, OPP, SPP, PBAP* ⁴ , HID, PAN, PAN NAP, PANU, aptX®, SCMS-T, HOGP* ⁵ , DUN* ⁶ Frequency bands: 2.4 GHz band
Network environment	Wireless LAN (Wi-Fi®) function: IEEE802.11a/b/g/n (2.4 GHz/5 GHz)* ⁷ /ac* ⁸ conformant
Interface	microUSB jack, 3.5ø (quadrupoles) earphone/microphone jack (supported earphones: tripolar headphone (Lch/Rch/GND) and quadrupolar earphone with microphone (Lch/Rch/GND/MIC))

*¹ The Full Seg/1Seg continuous watching time varies depending on the usage.

*² It changes according to objects obstructing devices and signal reception.

*³ This is the specification provided in Bluetooth® standards for making communication between Bluetooth®-compatible devices in accordance with their intended use.

*⁴ Some contents of address books data may not be properly displayed on the device of the other party.

*⁵ This profile supports Bluetooth® Standard Ver.4.0.

*⁶ Supported for some car navigation systems only. See the au homepage for usage.

*⁷ Supports MIMO.

*⁸ Supports MU-MIMO (Client mode).

◎ The continuous talk time and continuous standby time may drop to less than half depending on the battery charging status, usage environment such as temperature, reception condition at the location where the product is used, and the function settings.

■ SHARP TV Antenna Cable 01

Length	Approx. 14 cm (without plug)
Weight	Approx. 5 g
Ambient temperature/ humidity range	5°C – 35°C / 35% – 85%
Plug/jack	ø3.5 quadripolar plug / ø3.5 quadripolar jack

Specific Absorption Rate (SAR) of Cell Phones

This model [SHV32] cell phone complies with Japanese technical regulations for exposure to radio waves and international guidelines on radio wave protection.

This cell phone has been designed in observance of the Japanese technical regulations regarding exposure to radio waves (*1) and limits to exposure to radio waves recommended by equivalent international guidelines.

These international guidelines were set out by the International Commission on Non-Ionizing Radiation Protection (ICNIRP), which is in collaboration with the World Health Organization (WHO), and the permissible limits include a substantial safety margin designed to assure the safety of all persons, regardless of age and health condition. The Japanese technical regulations and international guidelines define the limits using a unit of measurement known as the Specific Absorption Rate (SAR), which represents the average amount of radio frequency energy absorbed by the human body. The SAR limit for cell phones is 2.0 W/kg. The highest SAR value for this cell phone when tested for use at the ear is 0.686 W/kg, and when worn on the body, is 0.543 W/kg (*2). There may be slight differences in SAR levels among individual products, but they all satisfy the limit.

The actual SAR of this cell phone while talking on the phone can be well below that indicated above. This is due to the cell phone being designed to only output the minimum power required to communicate with a base station. Therefore in general, the closer you are to a base station, the lower the power output of the cell phone.

This cell phone can be used in positions other than against your ear. Use a carrying case or similar accessory that holds the phone at least 1.5 cm separated from the body and ensure no metal parts are located between you and the cell phone. Under these conditions, this cell phone satisfies Japanese technical regulations and international guidelines for radio wave protection.

The World Health Organization has stated that "a large number of studies have been performed over the last two decades to assess whether mobile phones pose a potential health risk. To date, no adverse health effects have been established as being caused by mobile phone use".

If you would like to know more detailed information, please refer to the WHO website.

http://www.who.int/docstore/peh-emf/publications/facts_press/fact_english.htm

Please refer to the websites listed below if you would like to know more detailed information regarding SAR.

Ministry of Internal Affairs and Communications website:

<http://www.tele.soumu.go.jp/e/sys/ele/index.htm>

Association of Radio Industries and Businesses website:

<http://www.arib-emf.org/01denpa/denpa02-02.html>

SHARP homepage:

<http://k-tai.sharp.co.jp/support/sar/>

au homepage:

<http://www.au.kddi.com/english/>

*1 Technical regulations are defined by the Ministerial Ordinance Related to the Radio Law (Article 14-2 of Radio Equipment Regulations).

*2 The value is under simultaneous transmission use condition.

CE Declaration of Conformity

CE0168

In some countries/regions including Europe, there are restrictions on the use of 5GHz WLAN that may limit the use to indoors only. If you intend to use 5GHz WLAN on the device, check the local laws and regulations beforehand.

Hereby, Sharp Telecommunications of Europe Ltd, declares that this SHV32 is in compliance with the essential requirements and other relevant provisions of Directive 1999/5/EC. A copy of the original declaration of conformity can be found at the following Internet address:
<http://www.sharp.co.jp/k-tai/>

■ Mobile Light

Do not point the illuminated light directly at someone's eyes.

Be especially careful not to shoot small children from a very close distance.

Do not use Mobile light near people's faces. Eyesight may be temporarily affected leading to accidents.

■ AC Adapter

Any AC adapter used with this handset must be suitably approved with a 5Vdc SELV output which meets limited power source requirements as specified in EN/IEC 60950-1 clause 2.5.

■ Battery - CAUTION

Use specified Charger only.

Non-specified equipment use may cause malfunctions, electric shock or fire due to battery leakage, overheating or bursting.

The battery is embedded inside the product. Avoid removing the embedded battery since this may cause overheating or bursting.

Do not dispose of the product with ordinary refuse. Take the product to an au Shop, or follow the local disposal regulations.

Charge battery in ambient temperatures between 5°C and 35°C; outside this range, battery may leak/overheat and performance may deteriorate.

■ Volume Level Caution



To prevent possible hearing damage, do not listen at high volume levels for long periods.

■ Headphone Signal Level

The maximum output voltage for the music player function, measured in accordance with EN 50332-2, is 120 mV.

■ Stand-by Mark

 :This symbol means the stand-by on/off.

■ European RF Exposure Information

Your mobile device is a radio transmitter and receiver. It is designed not to exceed the limits for exposure to radio waves recommended by international guidelines. These guidelines were developed by the independent scientific organization ICNIRP and include safety margins designed to assure the protection of all persons, regardless of age and health.

The guidelines use a unit of measurement known as the Specific Absorption Rate, or SAR. The SAR limit for mobile devices is 2 W/kg and the highest SAR value for this device when tested at the ear is 0.674 W/kg* and when worn on the body is 0.629 W/kg*.

For body-worn operation, this mobile device has been tested and meets the RF exposure guidelines when used with an accessory containing no metal and positioning the handset a minimum of 1.5 cm from the body. Use of other accessories may not ensure compliance with RF exposure guidelines.

As SAR is measured utilizing the devices highest transmitting power the actual SAR of this device while operating is typically below that indicated above. This is due to automatic changes to the power level of the device to ensure it only uses the minimum level required to reach the network.

The World Health Organization has stated that present scientific information does not indicate the need for any special precautions for the use of mobile devices. They note that if you want to reduce your exposure then you can do so by limiting the length of calls or using a hands-free device to keep the mobile phone away from the head.

* The tests are carried out in accordance with international guidelines for testing.

FCC Notice

- This device complies with part 15 of the FCC Rules. Operation is subject to the following two conditions:
(1) This device may not cause harmful interference, and (2) this device must accept any interference received, including interference that may cause undesired operation.
- Changes or modifications not expressly approved by the manufacturer responsible for compliance could void the user's authority to operate the equipment.
- The device is electronically labeled and the FCC ID can be displayed via the Device info & the Authentication under the Setting menu.

Information to User

This equipment has been tested and found to comply with the limits of a Class B digital device, pursuant to Part 15 of the FCC Rules. These limits are designed to provide reasonable protection against harmful interference in a residential installation. This equipment generates, uses and can radiate radio frequency energy and, if not installed and used in accordance with the instructions, may cause harmful interference to radio communications.

However, there is no guarantee that interference will not occur in a particular installation; if this equipment does cause harmful interference to radio or television reception, which can be determined by turning the equipment off and on, the user is encouraged to try to correct the interference by one or more of the following measures:

1. Reorient/relocate the receiving antenna.
2. Increase the separation between the equipment and receiver.
3. Connect the equipment into an outlet on a circuit different from that to which the receiver is connected.
4. Consult the dealer or an experienced radio/TV technician for help and for additional suggestions.

Warning

The user is cautioned that changes or modifications not expressly approved by the manufacturer could void the user's authority to operate the equipment.

5 GHz WLAN Operation in USA

Within the 5.15-5.25 GHz band, UNII devices are restricted to indoor operations to reduce any potential for harmful interference to co-channel Mobile Satellite Services (MSS) operations.

FCC RF Exposure Information

Your handset is a radio transmitter and receiver. It is designed and manufactured not to exceed the emission limits for exposure to radio frequency (RF) energy set by the Federal Communications Commission of the U.S. Government.

The guidelines are based on standards that were developed by independent scientific organizations through periodic and thorough evaluation of scientific studies. The standards include a substantial safety margin designed to assure the safety of all persons, regardless of age and health.

The exposure standard for wireless handsets employs a unit of measurement known as the Specific Absorption Rate, or SAR. The SAR limit set by the FCC is 1.6 W/kg.

Highest SAR value:

Model	SHV32
FCC ID	APYHRO00218
At the Ear	0.76 W/kg
On the Body	0.78 W/kg

This device was tested for typical body-worn operations with the back of the handset kept 1.0 cm from the body. To maintain compliance with FCC RF exposure requirements, use accessories that maintain a 1.0 cm separation distance between the user's body and the back of the handset. The use of belt clips, holsters and similar accessories should not contain metallic components in its assembly.

The use of accessories that do not satisfy these requirements may not comply with FCC RF exposure requirements, and should be avoided.

The FCC has granted an Equipment Authorization for this model handset with all reported SAR levels evaluated as in compliance with the FCC RF emission guidelines. SAR information on this model handset is on file with the FCC and can be found at <http://transition.fcc.gov/oet/ea/fccid/> under the Display Grant section after searching on the corresponding FCC ID (see table above).

Additional information on Specific Absorption Rates (SAR) can be found on the FCC website at <http://www.fcc.gov/encyclopedia/radio-frequency-safety>.