

**SANYO**

---

**Multimedia Projector**

**MODEL PLC-XF47**

**PLC-XF47K**

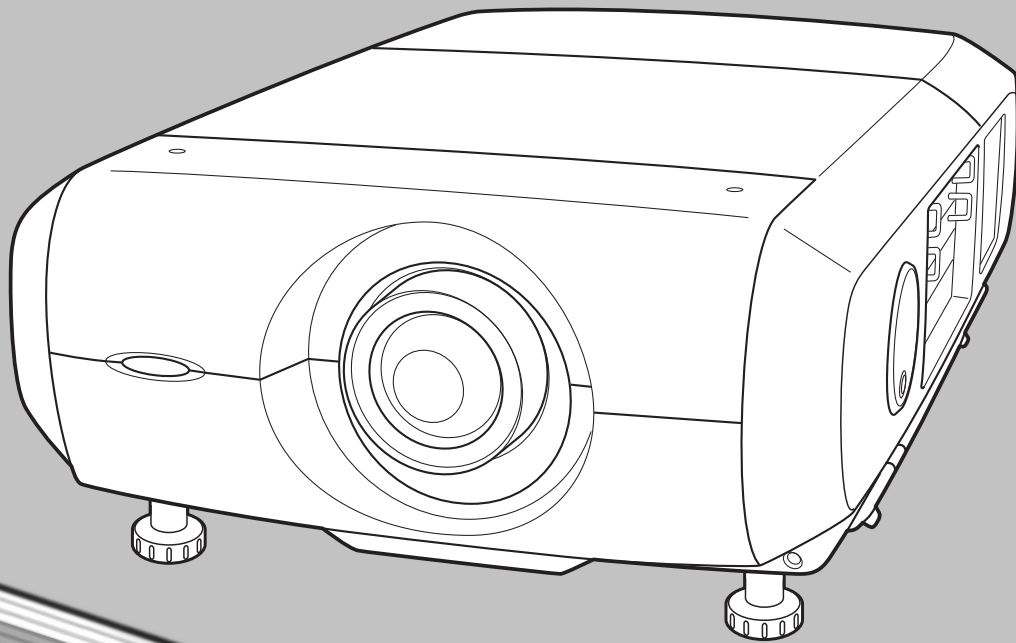

\* Projection lens is optional.

**Owner's Manual**

**PROJECTOR**

# Features and Design

This Multimedia Projector is designed with most advanced technology for portability, durability, and ease of use. This projector utilizes built-in multimedia features, a palette of 1.07 billion colors, and matrix liquid crystal display (LCD) technology.

## ◆ **Functionally Rich**

This projector has many useful functions such as lens shifting, ceiling and rear projection, variety of lens options, etc.

## ◆ **Simple Computer System Setting**

The projector has the Multi-scan system to conform to almost all computer output signals quickly (p.33). Up to UXGA resolution can be accepted.

## ◆ **Useful Functions for Presentation**

Digital zoom function allows you to focus on the crucial information during a presentation (pp.14, 39).

## ◆ **Security Function**

The Security function helps you to ensure security of the projector. With the Key lock function, you can lock the operation on the side control or remote control (p.53). PIN code lock functions prevents unauthorized use of the projector (pp.52–53).

## ◆ **Lamp Control**

Brightness of the projection lamp can be selected (p.50).

## ◆ **Power Management**

The Power management function reduces power consumption and maintains lamp life (p.51).

## ◆ **Multilanguage Menu Display**

Operation menu is available in 12 languages; English, German, French, Italian, Spanish, Portuguese, Dutch, Swedish, Russian, Chinese, Korean, and Japanese (p.47).

## ◆ **Logo Function**

The Logo function allows you to customize the screen logo (pp.48–49). You can capture an image for the screen logo and use it for the starting-up display or between presentations.

## ◆ **Motor-driven Lens Shift**

Projection lens can be moved up, down, right and left with the motor-driven lens shift function. This function makes it easy to provide projected image where you want. Zoom and focus can also be adjusted with a motor-driven operation. (p.27)

## ◆ **Multi Versatile Platform**

This projector applies various input/output terminals and 4 terminal slots for expansion to tune to diversity of signals from computers and video equipment (p.19). For Terminal Boards, contact sales dealer where you purchased a projector.

## ◆ **Network board (Optional)**

Network board is an optional product to control and set up a projector via the network cables with the web browser on your computer. It can be controlled and set up the projector remotely. Contact the sales dealer where you purchased this projector for optional parts.

### ✓ **Note:**

- The On-Screen Menu and figures in this manual may differ slightly from the product.
- The contents of this manual are subject to change without notice.

# Table of Contents

<b>Features and Design</b> . . . . .	<b>2</b>	<b>Input Selection</b> . . . . .	<b>30</b>
<b>Table of Contents</b> . . . . .	<b>3</b>	Input	30
<b>To The Owner</b> . . . . .	<b>4</b>	Computer Input Source Selection	31
<b>Safety Instructions</b> . . . . .	<b>5</b>	Video Input Source Selection	32
Air Circulation	6	<b>Computer Input</b> . . . . .	<b>33</b>
Installing the Projector in Proper Directions	7	Computer System Selection	33
Moving the Projector	8	Auto PC Adjustment	34
<b>Compliance</b> . . . . .	<b>9</b>	Manual PC Adjustment	35
<b>Part Names and Functions</b> . . . . .	<b>10</b>	Image Level Selection	37
Front	10	Screen Size Adjustment	38
Back	10	<b>Video Input</b> . . . . .	<b>40</b>
Bottom	10	Video System Selection	40
Input / Output Terminals and Jacks	11	Image Level Selection	41
Side Control and Indicators	12	Screen Size Adjustment	42
Side Controls	12	<b>Picture Image</b> . . . . .	<b>44</b>
Indicators	13	Image Adjustment	44
Remote Control	14	<b>Setting</b> . . . . .	<b>47</b>
Remote Control Battery Installation	15	Setting	47
Remote Control Receivers and Operating Range	15	<b>Maintenance and Care</b> . . . . .	<b>55</b>
Wired Remote Control	15	Air Filter Care and Cleaning	55
Remote Control Code	16	Resetting the Filter Counter	55
<b>Installation</b> . . . . .	<b>17</b>	Lamp Management	56
Lens Installation	17	Lamp Replacement	57
Positioning Projector	17	Resetting the Lamp Counter	58
Lens Shift Adjustment	18	Cleaning the Projection Lens	60
Picture Level and Pitch Adjustment	18	Cleaning the Projector Cabinet	60
Terminals of Projector	19	Warning Indicators	61
Connecting to Computer	20	<b>Appendix</b> . . . . .	<b>62</b>
Connecting to Video Equipment	21	Troubleshooting	62
Connecting the AC Power Cord	22	Menu Tree	65
<b>Basic Operation</b> . . . . .	<b>23</b>	Indicators and Projector Condition	68
Turning On the Projector	23	Compatible Computer Specifications	70
Turning Off the Projector	24	Technical Specifications	72
How to Operate the On-Screen Menu	25	Optional Parts	73
Menu Bar	26	Configurations of Terminals	74
Operating with Projector Control	27	PIN Code Number Memo	75
Operating with Remote Control	28	Dimensions	76
		Serial Control Interface	77

## Trademarks

Each name of corporations or products in this book is either a registered trademark or a trademark of its respective corporation.





# To The Owner

Before installing and operating the projector, read this manual thoroughly.

The projector provides many convenient features and functions. Operating the projector properly enables you to manage those features and maintains it in good condition for many years to come.

Improper operation may result in not only shortening the product life, but also malfunctions, fire hazard, or other accidents.

If your projector seems to operate improperly, read this manual again, check operations and cable connections and try the solutions in the "Troubleshooting" section in the back of this booklet. If the problem still persists, contact the dealer where you purchased the projector or the service center.

	<b>CAUTION</b> <b>RISK OF ELECTRIC SHOCK</b> <b>DO NOT OPEN</b>	
<b>CAUTION: TO REDUCE THE RISK OF ELECTRIC SHOCK, DO NOT REMOVE COVER (OR BACK). NO USER-SERVICEABLE PARTS INSIDE EXCEPT LAMP REPLACEMENT. REFER SERVICING TO QUALIFIED SERVICE PERSONNEL.</b>		
	THIS SYMBOL INDICATES THAT DANGEROUS VOLTAGE CONSTITUTING A RISK OF ELECTRIC SHOCK IS PRESENT WITHIN THIS UNIT.	
	THIS SYMBOL INDICATES THAT THERE ARE IMPORTANT OPERATING AND MAINTENANCE INSTRUCTIONS IN THE OWNER'S MANUAL WITH THIS UNIT.	

**NOTE:** This symbol and recycle system are applied only to EU countries and not applied to the countries in the other area of the world.



Your SANYO product is designed and manufactured with high quality materials and components which can be recycled and reused.

This symbol means that electrical and electronic equipment, at their end-of-life, should be disposed of separately from your household waste.

Please dispose of this equipment at your local community waste collection/recycling centre.

In the European Union there are separate collection systems for used electrical and electronic products.

Please help us to conserve the environment we live in!

**READ AND KEEP THIS OWNER'S MANUAL FOR LATER USE.**



## Safety Precaution

**WARNING: TO REDUCE THE RISK OF FIRE OR ELECTRIC SHOCK, DO NOT EXPOSE THIS APPLIANCE TO RAIN OR MOISTURE.**

- This projector produces intense light from the projection lens. Do not stare directly into the lens, otherwise eye damage could result. Be especially careful that children do not stare directly into the beam.
- Install the projector in a proper position. Otherwise it may result in a fire hazard.
- Allowing the proper amount of space on the top, sides, and rear of the projector cabinet is critical for proper air circulation and cooling of the unit. The diagrams shown here indicates the minimum space required. If the projector is to be built into a compartment or similarly enclosed, these minimum distances must be maintained.
- Do not cover the ventilation slots on the projector. Heat build-up can reduce the service life of your projector, and can also be dangerous.

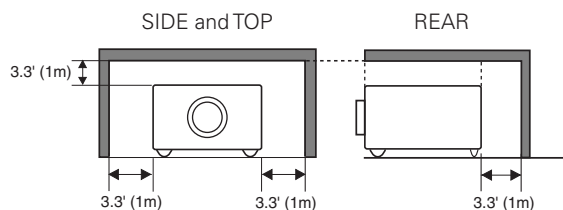

- If the projector is unused for an extended time, unplug the projector from the power outlet.



## CAUTION ON HANGING FROM THE CEILING

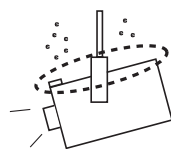

When hanging the projector from the ceiling, clean the air intake vents and top of the projector periodically with a vacuum cleaner. If you leave the projector unclean for a long time, the cooling fans can be clogged with dust, and it may cause a breakdown or a disaster.

**DO NOT SET THE PROJECTOR IN GREASY, WET, OR SMOKY CONDITIONS SUCH AS IN A KITCHEN TO PREVENT A BREAKDOWN OR A DISASTER. IF THE PROJECTOR COMES IN CONTACT WITH OIL OR CHEMICALS, IT MAY BECOME DETERIORATED.**

## CAUTION

Not for use in a computer room as defined in the Standard for the Protection of Electronic Computer/Data Processing Equipment, ANSI/NFPA 75.

Ne peut être utilisé dans une salle d'ordinateurs telle que définie dans la norme ANSI/NFPA 75 Standard for Protection of Electronic Computer/Data Processing Equipment.

# Safety Instructions

All the safety and operating instructions should be read before the product is operated.

Read all of the instructions given here and retain them for later use. Unplug this projector from AC power supply before cleaning. Do not use liquid or aerosol cleaners. Use a damp cloth for cleaning.

Follow all warnings and instructions marked on the projector.

For added protection to the projector during a lightning storm, or when it is left unattended and unused for long periods of time, unplug it from the wall outlet. This will prevent damage due to lightning and power line surges.

---

Do not expose this unit to rain or use near water... for example, in a wet basement, near a swimming pool, etc...

Do not use attachments not recommended by the manufacturer as they may cause hazards.

Do not place this projector on an unstable cart, stand, or table. The projector may fall, causing serious injury to a child or adult, and serious damage to the projector. Use only with a cart or stand recommended by the manufacturer, or sold with the projector. Wall or shelf mounting should follow the manufacturer's instructions, and should use a mounting kit approved by the manufacturers.

An appliance and cart combination should be moved with care. Quick stops, excessive force, and uneven surfaces may cause the appliance and cart combination to overturn.



---

Slots and openings in the back and bottom of the cabinet are provided for ventilation, to ensure reliable operation of the equipment and to protect it from overheating.

The openings should never be covered with cloth or other materials, and the bottom opening should not be blocked by placing the projector on a bed, sofa, rug, or other similar surface. This projector should never be placed near or over a radiator or heat register.

This projector should not be placed in a built-in installation such as a book case unless proper ventilation is provided.

Never push objects of any kind into this projector through cabinet slots as they may touch dangerous voltage points or short out parts that could result in a fire or electric shock. Never spill liquid of any kind on the projector.

Do not install the projector near the ventilation duct of air-conditioning equipment.

This projector should be operated only from the type of power source indicated on the marking label. If you are not sure of the type of power supplied, consult your authorized dealer or local power company.

Do not overload wall outlets and extension cords as this can result in fire or electric shock. Do not allow anything to rest on the power cord. Do not locate this projector where the cord may be damaged by persons walking on it.

Do not attempt to service this projector yourself as opening or removing covers may expose you to dangerous voltage or other hazards. Refer all servicing to qualified service personnel.

Unplug this projector from wall outlet and refer servicing to qualified service personnel under the following conditions:

- a. When the power cord or plug is damaged or frayed.
- b. If liquid has been spilled into the projector.
- c. If the projector has been exposed to rain or water.
- d. If the projector does not operate normally by following the operating instructions. Adjust only those controls that are covered by the operating instructions as improper adjustment of other controls may result in damage and will often require extensive work by a qualified technician to restore the projector to normal operation.
- e. If the projector has been dropped or the cabinet has been damaged.
- f. When the projector exhibits a distinct change in performance-this indicates a need for service.

When replacement parts are required, be sure the service technician has used replacement parts specified by the manufacturer that have the same characteristics as the original part. Unauthorized substitutions may result in fire, electric shock, or injury to persons.

Upon completion of any service or repairs to this projector, ask the service technician to perform routine safety checks to determine that the projector is in safe operating condition.

# Safety Instructions

## Air Circulation

Openings in the cabinet are provided for ventilation. To ensure reliable operation of the product and to protect it from overheating, these openings must not be blocked or covered.

### CAUTION

Hot air is exhausted from the exhaust vent. When using or installing the projector, the following precautions should be taken.

- Do not put any flammable object or spray can near the projector, hot air is exhausted from the air vents.
- Keep the exhaust vent at least 3' (1 m) away from any objects.
- Do not touch peripheral parts of the exhaust vent, especially screws and metallic parts. These areas will become hot while the projector is being used.
- Do not put anything on the cabinet. Objects put on the cabinet will not only get damaged but also may cause fire hazard by heat.
- Do not cover vents with papers or other materials.
- Make sure that there are no objects under a projector. An object under a projector may prevent a projector from taking cooling air through bottom vent.

Cooling fans are provided to cool down the projector. The fans' running speed is changed according to the temperature inside the projector.

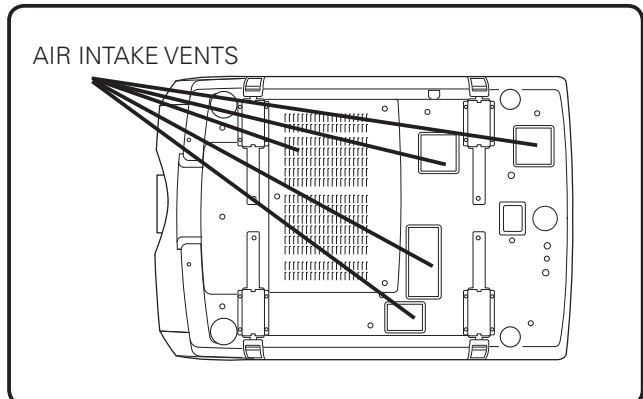
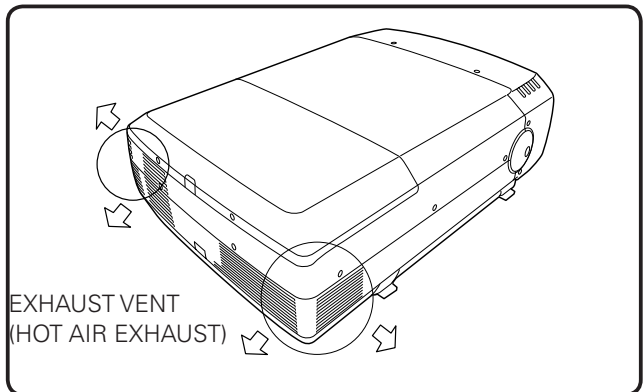
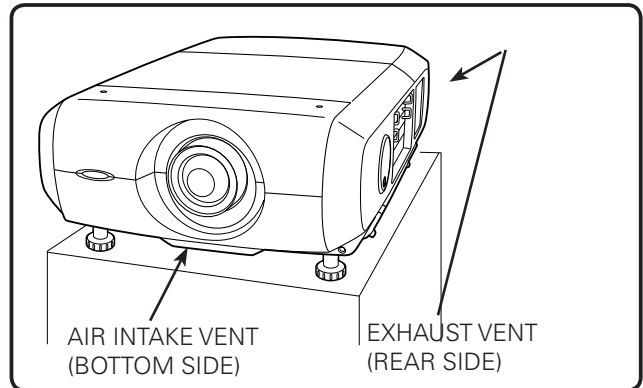

## IMPORTANT!

### Filter Maintenance!!

The projector uses a lamp which generates significant heat. The cooling fans and air vents are provided to dissipate the heat by drawing air into the housing and the filter is located in the intake vents to prevent dust from getting inside of the projector.

In order to care for the projector appropriately, regular cleaning is required. Remove any dirt or dust that has accumulated on the projector or in the filter.

If the projector reaches a time set in the timer setting, a Filter warning icon (Fig. 1) appears on the screen.

Blocking the air vents and leaving the projector uncleaned for a long time may not only damage the projector and may require costly repairs but may also cause accidents or fire.

For maintenance of the filter, refer to "Filter counter" on page 54 and "Maintenance and Care" on pages 55.

**Damages to the projector caused by using an uncleaned filter or improper maintenance will void the warranty on the projector.**



**Fig.1** Filter warning icon

## Installing the Projector in Proper Directions

Use the projector properly in specified positions. Improper positioning may reduce the lamp life and result in severe accident or fire hazard.

### Positioning Precautions

Avoid positioning the projector as described below when installing.

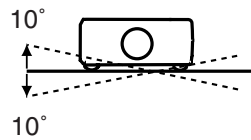

Do not roll the projector more than 10 degrees from side to side.



**NO UPWARD**

Do not point the projector up to project an image.



**NO DOWNWARD**

Do not point the projector down to project an image.



**NO SIDWAYS**

Do not put the projector on either side to project an image.

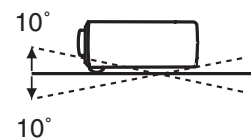

Do not pitch the projector more than 10 degrees backward and forward.



### CAUTION ON CEILING MOUNTING

For ceiling mounting, you need the ceiling mount kit designed for this projector. When not mounted properly, the projector may fall, causing hazards or injury. For details, consult your dealer. The warranty on this projector does not cover any damage caused by use of any non-recommended ceiling mount kit or installation of the ceiling mount kit in an improper location.



## Moving the Projector



For safety, be sure to hold Carrying Handles on both sides by 2 or more people when moving a projector. Moving it improperly may result in damage of cabinet or person's injury.

Replace lens cap and retract feet to prevent damage to lens and cabinet.

- 1** Pull up lock buttons on each side of carrying handles to release locks.
- 2** Pull carrying handles out fully until the handles click. Move a projector by holding two handles by 2 or more people.
- 3** To retract carrying handles, pull up lock buttons to release lock of handles and press handles fully in until the handles are locked.

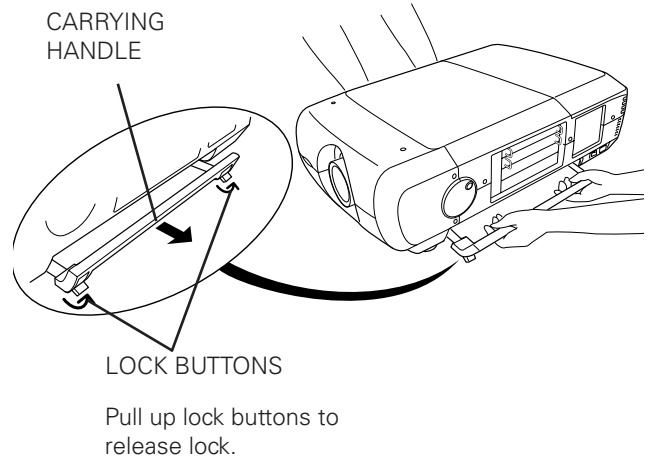

### CAUTION IN CARRYING OR TRANSPORTING THE PROJECTOR

- Do not drop or bump the projector, otherwise damages or malfunctions may result.
- When carrying the projector, use a suitable carrying case.
- Do not transport the projector by courier or any other transport service in an unsuitable transport case. This may cause damage to the projector. For information about transporting the projector by courier or any other transport service, consult your dealer.
- Do not put the projector in a case before it is cooled enough.



# Compliance

## Federal Communications Commission Notice

This equipment has been tested and found to comply with the limits for a Class A digital device, pursuant to Part 15 of FCC Rules. These limits are designed to provide reasonable protection against harmful interference when the equipment is operated in a commercial environment. This equipment generates, uses, and can radiate radio frequency energy and, if not installed and used in accordance with the instruction manual, may cause harmful interference to radio communications. Operation of this equipment in a residential area is likely to cause harmful interference in which case the user will be required to correct the interference at his own expense.

Do not make any changes or modifications to the equipment unless otherwise specified in the instructions. If such changes or modifications should be made, you could be required to stop operation of the equipment.

## Canadian Radio Interference Regulations

This Class A digital apparatus meets all requirements of the Canadian ICES-003.

## WARNING

This is a Class A product. In a domestic environment this product may cause radio interference in which case the user may be required to take adequate measures.

## AC Power Cord Requirement

The AC Power Cord supplied with this projector meets the requirement for use in the country you purchased it.

### AC Power Cord for the United States and Canada:

AC Power Cord used in the United States and Canada is listed by the Underwriters Laboratories (UL) and certified by the Canadian Standard Association (CSA).

AC Power Cord has a grounding-type AC line plug. This is a safety feature to be sure that the plug will fit into the power outlet. Do not try to defeat this safety feature. Should you be unable to insert the plug into the outlet, contact your electrician.

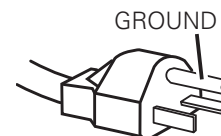

### AC Power Cord for the United Kingdom:

This cord is already fitted with a moulded plug incorporating a fuse, the value of which is indicated on the pin face of the plug. Should the fuse need to be replaced, an ASTA approved BS 1362 fuse must be used of the same rating, marked thus  $\diamond$ . If the fuse cover is detachable, never use the plug with the cover omitted. If a replacement fuse cover is required, ensure it is of the same colour as that visible on the pin face of the plug (i.e. red or orange). Fuse covers are available from the Parts Department indicated in your User Instructions.

If the plug supplied is not suitable for your socket outlet, it should be cut off and destroyed.

The end of the flexible cord should be suitably prepared and the correct plug fitted.

### **WARNING: A PLUG WITH BARED FLEXIBLE CORD IS HAZARDOUS IF ENGAGED IN A LIVE SOCKET OUTLET.**

The Wires in this mains lead are coloured in accordance with the following code:

- Green-and-yellow ..... Earth
- Blue ..... Neutral
- Brown ..... Live

As the colours of the wires in the mains lead of this apparatus may not correspond with the coloured markings identifying the terminals in your plug proceed as follows:

The wire which is coloured green-and-yellow must be connected to the terminal in the plug which is marked by the letter E or by the safety earth symbol  $\perp$  or coloured green or green-and-yellow.

The wire which is coloured blue must be connected to the terminal which is marked with the letter N or coloured black.

The wire which is coloured brown must be connected to the terminal which is marked with the letter L or coloured red.

### **WARNING: THIS APPARATUS MUST BE EARTHED.**

**THE SOCKET-OUTLET SHOULD BE INSTALLED NEAR THE EQUIPMENT AND EASILY ACCESSIBLE.**

# Part Names and Functions

## Front

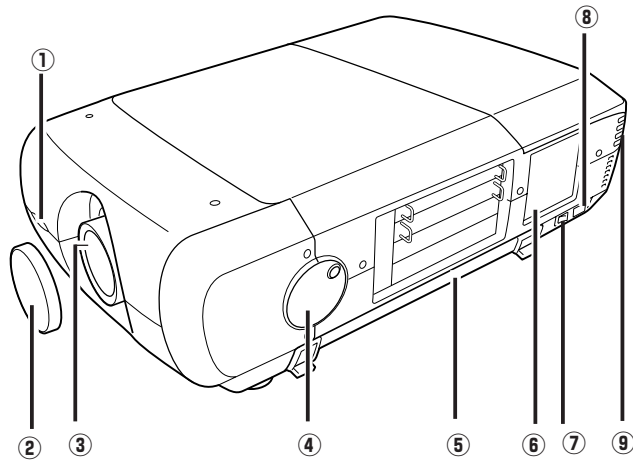

- ① Infrared Remote Receiver (Front)
- ② Lens Cap (Option)
- ③ Projection Lens (Option)
- ④ Level and Pitch Adjust Handle
- ⑤ Carrying Handle
- ⑥ Side Control
- ⑦ Main On/Off Switch
- ⑧ Power Cord Connector
- ⑨ Indicator (Rear)

## Back

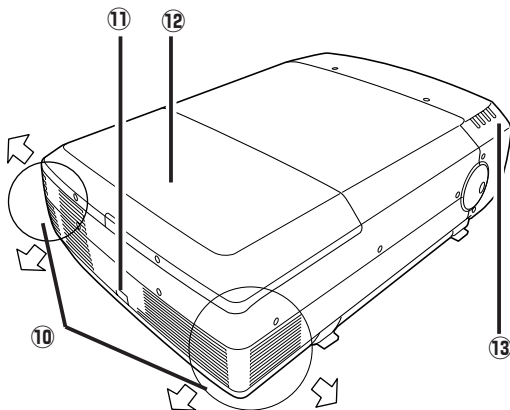

## ⚠ CAUTION

Hot air is exhausted from the exhaust vent. Do not put heat-sensitive objects near this side.

- ⑩ Exhaust Vent
- ⑪ Infrared Remote Receiver (Rear)
- ⑫ Lamp Cover
- ⑬ Indicator (Front)
- ⑭ Air Intake Vent
- ⑮ Adjustable Feet
- ⑯ Air Filter

## Bottom

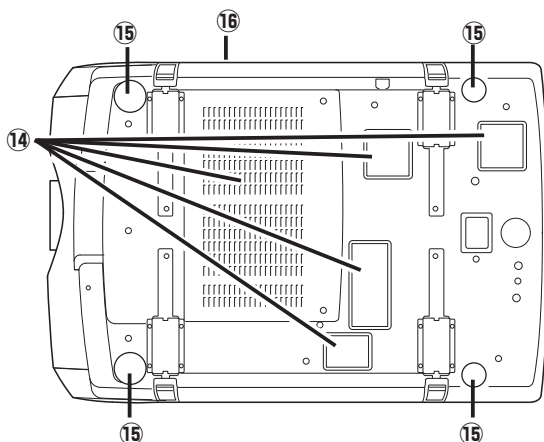

**Input / Output Terminals and Jacks**

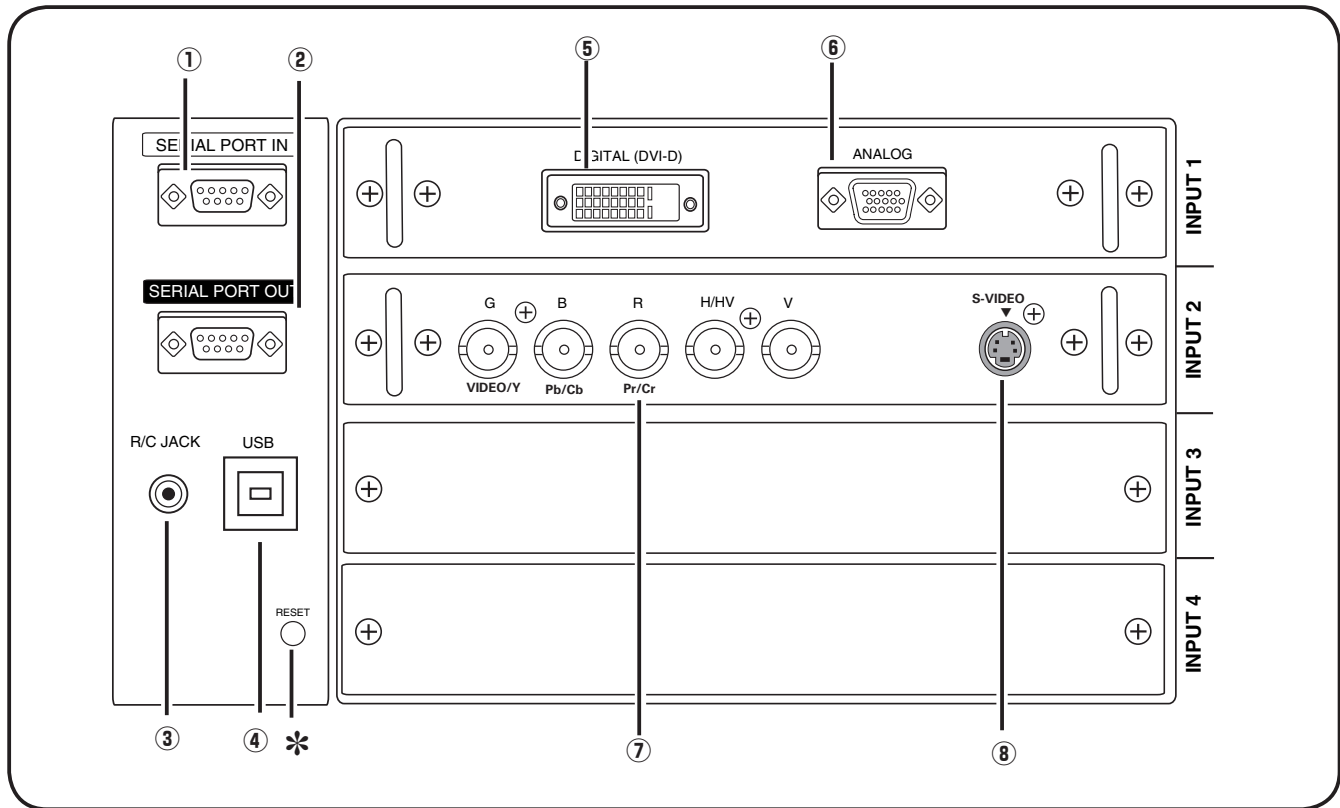

**① SERIAL PORT INTERMINAL**

If you control a projector by computer, you must connect a cable (not supplied) from your computer to this terminal.

**② SERIAL PORT OUT TERMINAL**

This terminal outputs signal from SERIAL PORT IN. More than two projectors can be controlled with one computer by connecting SERIAL PORT IN. of another projector to this terminal.

**③ R/C JACK**

When using the wired remote control, connect the wired remote control to this jack with a remote control cable (not supplied).

**④ USB CONNECTOR (Series B)**

Use this connector when controlling a computer with the remote control of the projector. Connect the USB terminal of your computer to this connector with the USB cable (not supplied).

**\* RESET button**

*A built-in micro processor which controls this unit may occasionally malfunction and need to be reset. This can be done by pressing the RESET button with a pen, which will shut down and restart the unit. Do not use the RESET function excessively.*

**⑤ DVI INPUT TERMINAL**

Connect computer output (Digital/DVI-D type) to this terminal. (Refer to p.20)  
HD (HDCP Compatible) signal can be also connected. (Refer to p.21)

**⑥ D-sub 15-PIN INPUT TERMINAL**

Connect computer output (Analog D-sub 15-pin type) to this terminal. (Refer to p.20)

**⑦ 5 BNC INPUT JACKS**

Connect the component or composite video output signal from video equipment to VIDEO/Y, Pb/Cb, and Pr/Cr jacks or connect the computer output signal (5 BNC Type [Green, Blue, Red, Horiz. Sync, and Vert. Sync.]) to G, B, R, H/V, and V jacks (pp.20–21).

**⑧ S-VIDEO INPUT JACK**

Connect the S-VIDEO output signal from video equipment to this jack (p.21).

## Side Control and Indicators

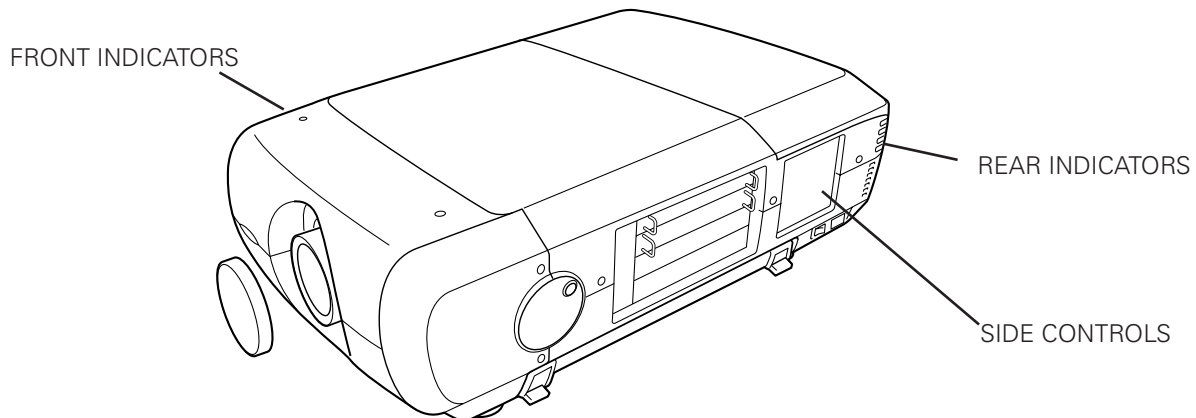

## Side Controls

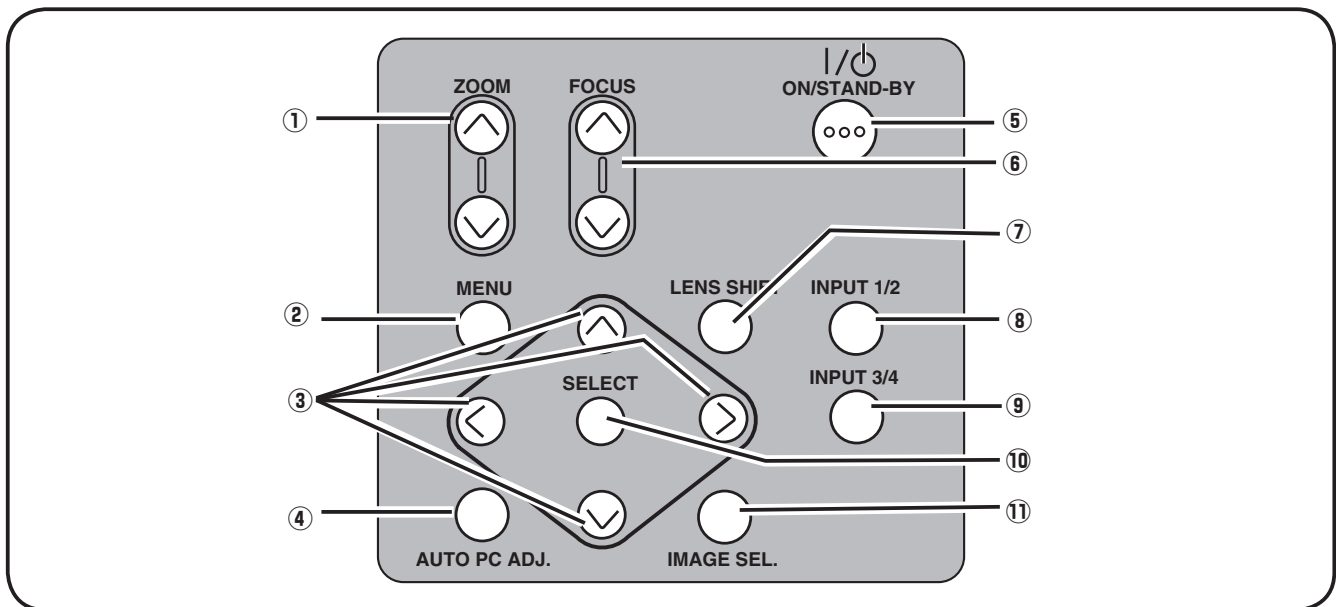

- ① **ZOOM buttons**  
Zoom in and out the images. (p.27)
- ② **MENU button**  
Open or close the On-Screen MENU. (p.25, 26)
- ③ **POINT button**  
- Select an item or adjust the value in the On-Screen MENU.  
- Pan the image in DIGITAL ZOOM + mode. (p.39)
- ④ **AUTO PC ADJ. button**  
Automatically adjusts the computer image to its optimum setting. (p.27)
- ⑤ **ON/STAND-BY button**  
Turn the projector on or off. (p.24)
- ⑥ **FOCUS buttons**  
Adjust the focus. (p.27)
- ⑦ **LENS SHIFT button**  
Select the LENS SHIFT function. (p.27)
- ⑧ **INPUT 1/2 button**  
Select an input source either INPUT 1 or INPUT 2. (pp.30-32)
- ⑨ **INPUT 3/4 button**  
Select an input source either INPUT 3 or INPUT 4. (p.30)
- ⑩ **SELECT button**  
Used to execute the selected item. It is also used to expand image in DIGITAL ZOOM mode. (p.39)
- ⑪ **IMAGE SEL. button**  
Select the image level. (p.37, 41)

**Indicators**

**Front Indicators**

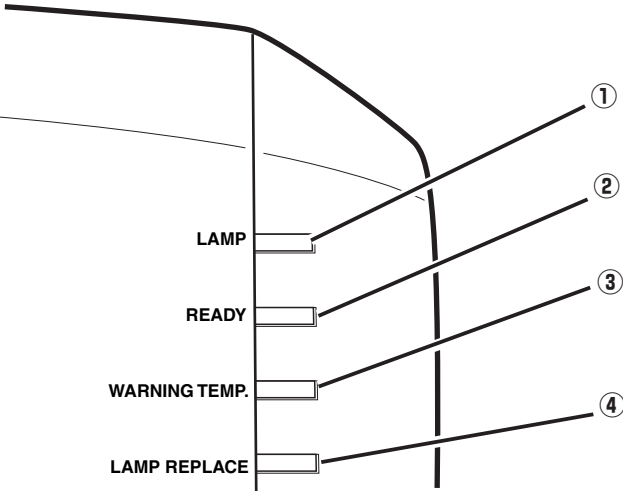

- ① **LAMP Indicator**  
This indicator is dim when a projector is turned on. And bright when a projector is in stand-by mode. (pp.68-69)
- ② **READY indicator**  
This indicator lights green when a projector is ready to be turned on. And it flashes green in Power Management mode. (pp.51, 68-69)

**Rear Indicators**

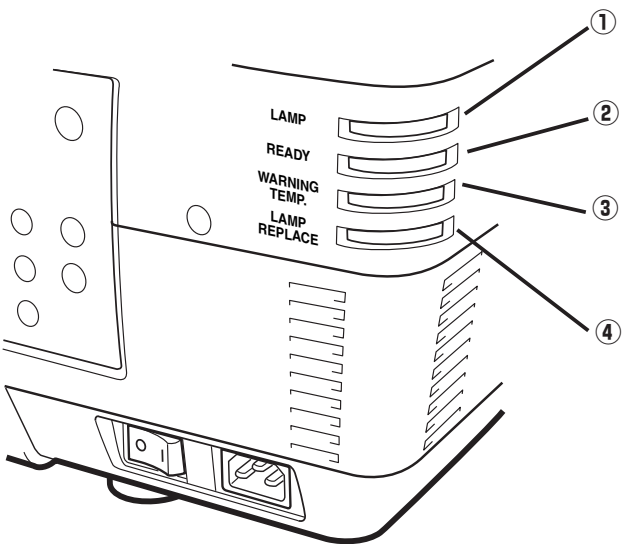

- ③ **WARNING TEMP. indicator**  
This indicator flashes red when internal projector temperature is too high. (pp.61, 68-69)
- ④ **LAMP REPLACE indicator**  
This LAMP REPLACE indicator lights orange when any of projection lamps is nearing its end, and flashes when any of them becomes out. Check which lamp needs to be replaced on Lamp Status Display. (pp.56, 68-69)

## Remote Control

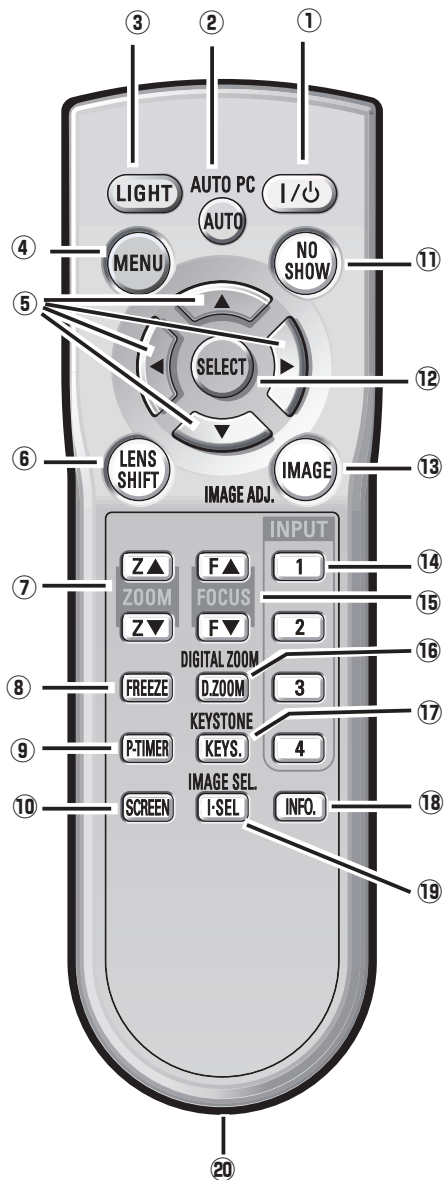

**✓ Note:**

To ensure safe operation, observe the following precautions:

- Do not bend, drop, or expose the remote control to moisture or heat.
- For cleaning, use a soft dry cloth. Do not apply benzene, thinner, splay, or any other chemical materials.

- ① **ON/STAND-BY button**  
Turn the projector on or off. (p.23)
- ② **AUTO PC button**  
Automatically adjust the computer image to its optimum setting (pp.28, 34).
- ③ **LIGHT button**  
Light the buttons on the remote control for about 10 seconds.
- ④ **MENU button**  
Open or close the On-Screen MENU. (pp.25-26)
- ⑤ **POINT ▲▼◀▶ buttons**  
–Select an item or adjust the value in The ON-SCREEN MENU.  
–Pan the image in DIGITAL ZOOM +/- mode. (p.39)
- ⑥ **LENS SHIFT button**  
Select the LENS SHIFT function. (p.27)
- ⑦ **ZOOM buttons**  
Zoom in and out the images.
- ⑧ **FREEZE button**  
Freeze the picture on the screen. (p.28)
- ⑨ **P-TIMER button**  
Operate the P-TIMER function. (p.29)
- ⑩ **SCREEN button**  
Select the screen size (pp.38-39).
- ⑪ **NO SHOW button**  
Temporarily turn off the image on the screen. (p.29)
- ⑫ **SELECT button**  
–Execute the selected item.  
–Expand or compress the image in the DIGITAL ZOOM mode. (p.39)
- ⑬ **IMAGE ADJ. button**  
Enter the image level adjustment mode. (pp.44-46)
- ⑭ **INPUT 1, 2, 3, 4 buttons**  
Select an input source. (pp.30-32)
- ⑮ **FOCUS buttons**  
Adjust the focus. (p.28)
- ⑯ **D.ZOOM button**  
Select the Digital zoom +/- mode and resize the image (p.39).
- ⑰ **KEYSTONE button**  
Correct keystone distortion. (pp.29,39,43)
- ⑱ **INFO. button**  
Display the input source information (p.28).
- ⑲ **IMAGE SEL. button**  
Select the image level. (pp.37, 41)
- ⑳ **Wired Remote Jack**  
connect the remote control cable (not supplied) to this jack when using as a wired remote control.

## Remote Control Battery Installation

- 1** Open the battery compartment lid.

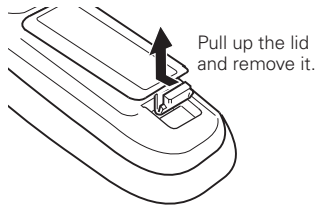

- 2** Install new batteries into the compartment.

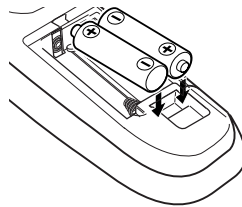

**Two AA size batteries**  
For correct polarity (+ and -), be sure battery terminals are in contact with pins in the compartment.

- 3** Replace the compartment lid.

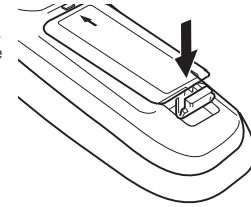

To ensure safe operation, please observe the following precautions :

- Use two (2) AA or LR6 type alkaline batteries.
- Always replace batteries in sets.
- Do not use a new battery with a used battery.
- Avoid contact with water or liquid.
- Do not expose the remote control to moisture or heat.
- Do not drop the remote control.
- If the battery has leaked on the remote control, carefully wipe the case clean and install new batteries.
- Risk of an explosion if battery is replaced by an incorrect type.
- Dispose of used batteries according to the instructions.

## Remote Control Receivers and Operating Range

Point the remote control toward the projector (to Infrared Remote Receivers) when pressing the buttons. Maximum operating range for the remote control is about 16.4' (5 m) and 60 degrees in front and rear of the projector.

Infrared Remote Receivers are provided both in front and back of the projector. You can conveniently use both of the receivers (pp. 10, 51)

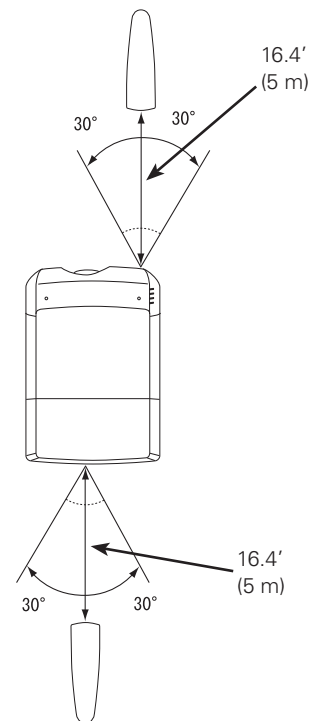

## Wired Remote Control

The remote control can be used as a wired remote control. Wired remote control helps you use the remote control outside of the operating range (16.4'/5 m). Connect the remote control and the projector with the remote control cable (sold separately). Connected with the remote control cable, the remote control does not emit wireless signal.



## Remote Control Code

The eight different remote control codes (Code 1–Code 8) are assigned to this projector. Switching the remote control codes prevents interference from other remote controls when several projectors or video equipment next to each other are operated at the same time. Change the remote control code for the projector first before changing that for the remote control. See “Remote control” in the Setting Menu on page 50.

- 1** Check the Reset Switch to "Use position" in the compartment lid on the back of the remote control.
- 2** During holding down the MENU button, press the IMAGE ADJ. button corresponding times to the number of the remote control code for the projector.

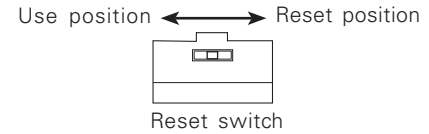

Remote Control Code	Number of Times Pressing IMAGE ADJ. button
Code 1	1
Code 2	2
Code 3	3
Code 4	4
Code 5	5
Code 6	6
Code 7	7
Code 8	8

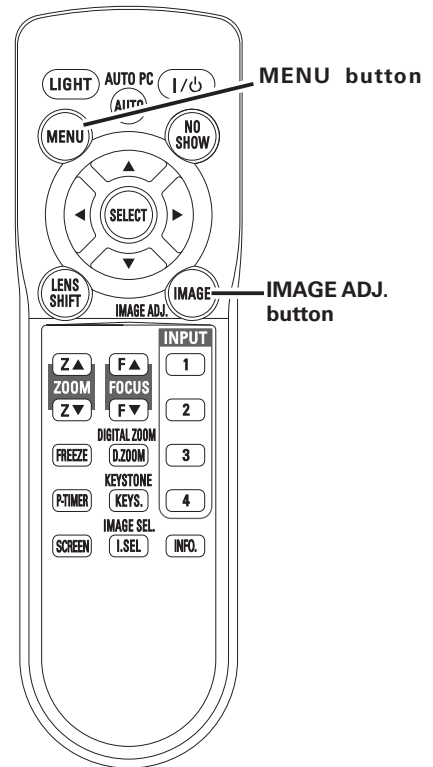

# Installation

## ***Lens Installation***

Before setting up a projector, install Projection Lens on a Projector.

1. Before installation, check where a projector is used and prepare a suitable lens. For the specifications of Projection Lens, refer to the manual attached separately or contact sales dealer where you purchased the projector.
2. For installation, refer to the installation manual accompanying a Projector.



When setting a projector after lens installation, be sure to replace a Lens Cap to protect a surface. And when carrying or holding up the projector, be careful not to put your hands on lens part. It may damage lens, cabinet, or mechanical parts.

## ***Positioning Projector***

This projector is designed to project on a flat projection surface.

***✓Note:***

***•Brightness in room has a great influence on picture quality. It is recommended to limit ambient lighting in order to provide the best image.***

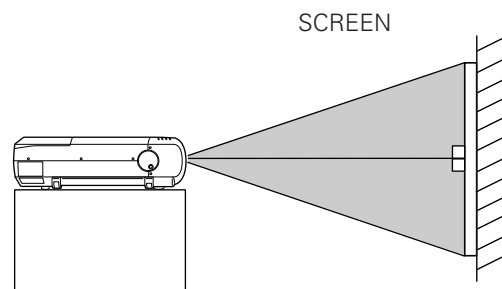

## Lens Shift Adjustment

Projection lens can be moved from side to side and up and down with the motor-driven lens shift function. This function makes the positioning of images easy on the screen. (See page 27)

The display position can be shifted upward up to 50% elevation of the display.

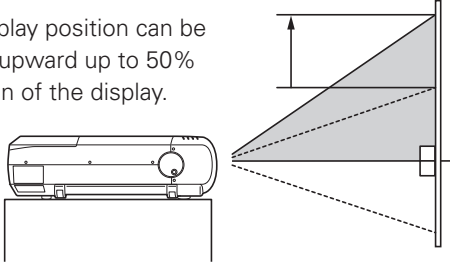

**When the lens is shifted to top.**

The display position can be shifted downward up to 50% low level of the display.

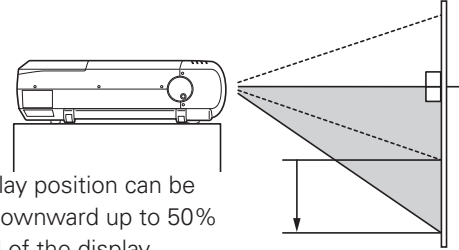

**When the lens is shifted to bottom.**

The display position can be shifted to the left in up to 10% width of the display.

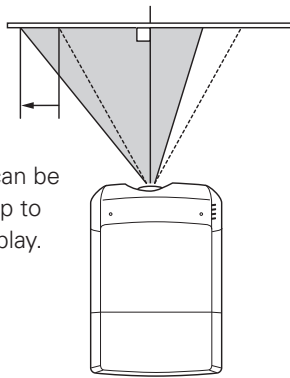

**When the lens is shifted to leftmost.**

The display position can be shifted to the right in up to 10% width of the display.

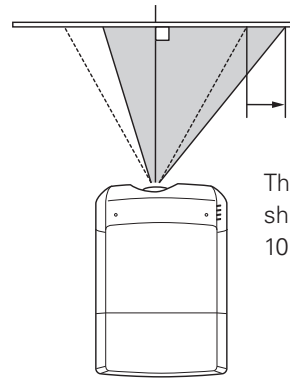

**When the lens is shifted to rightmost.**

## Picture Level and Pitch Adjustment

Picture tilt and projection angle can be adjusted with handles on both sides of a projector. Projection angle can be adjusted to 5.7 degrees upward.

- 1** Press the knob on the handle. The handle pops out.
- 2** Turn handles (right and left) until picture is projected on proper position. Rotate rear adjustable feet to stabilize the projector on a table.
- 3** Press the knob and retract the handle.

REAR ADJUSTABLE FEET. (Refer to p.10).  
LEVEL AND PITCH ADJUST HANDLE

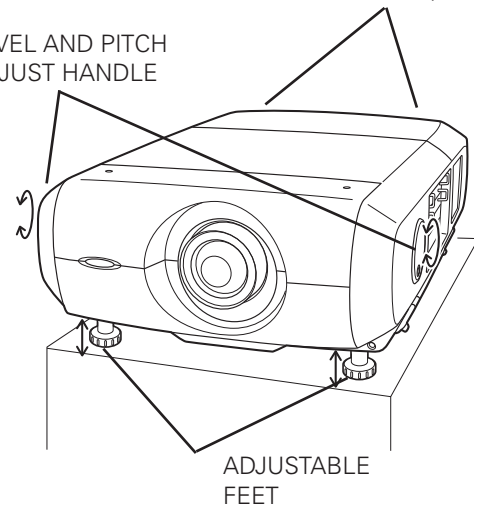

Height of front feet can be adjusted by turning handles.

## Terminals of Projector

This projector applies various input/output terminals and 4 terminal slots for expansion to tune to diversity of signals from computers and video equipment. 4-built-in Terminal Slots enable you to arrange desired combinations of input sources just by changing Terminal Boards. For Terminal Boards, contact sales dealer where you purchased a projector.

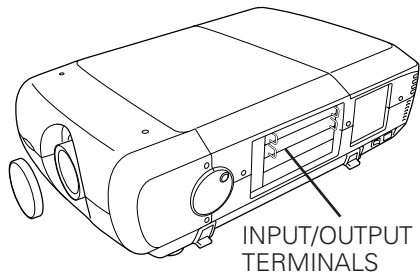

4 TERMINAL SLOTS (Factory set)

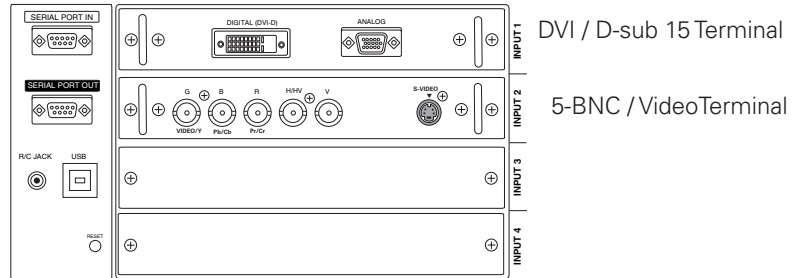

## Replacement of Terminal

✓ **Note:**

- In the replacement of terminal board, the MAIN ON/OFF switch should be OFF position.

- 1 Remove 2 Screws on a terminal.
- 2 Pull out the terminal by holding handle.
- 3 Replace the terminal. Insert a new terminal along Guide to fit Plug into Socket.
- 4 Tighten screws to secure the terminal.

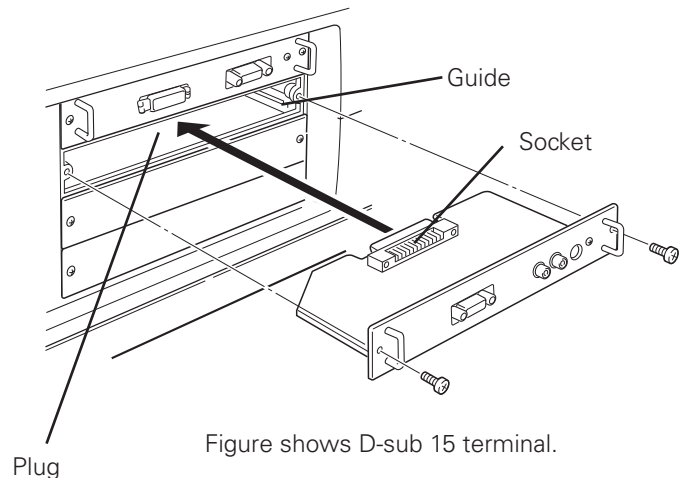
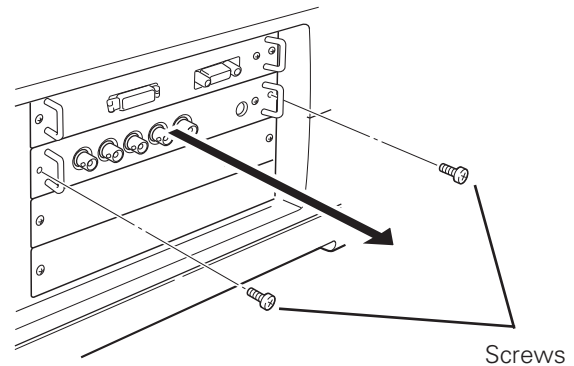

## NOTES ON ORDERING OR USING OPTIONAL INTERFACE BOARD

When ordering or using Optional Interface Board (Terminal Board), contact your sales dealer. When contacting the sales dealer, tell the Option Control Number (Op.cont.No.) in the menu that is located on the bottom of the information menu. (See page 28)

## Connecting to Computer

### Cables used for connection

- VGA Cable (D-sub 15 pin) \*
  - DVI Cable
  - BNC Cable (BNC x 5)
- (\*One cable is supplied; Other cables are not supplied with this projector.)

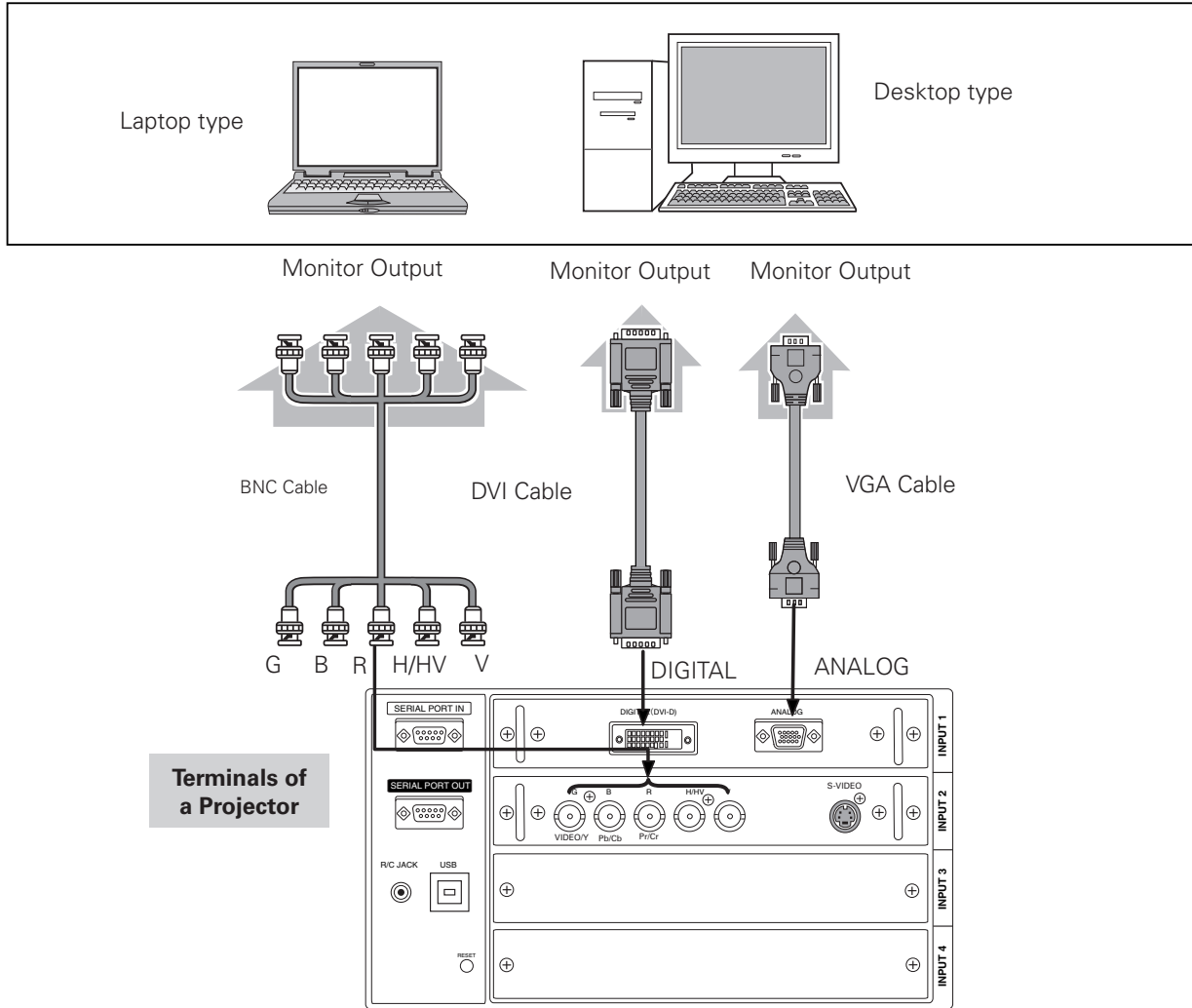

*Unplug the power cords of both the projector and external equipment from the AC outlet before connecting cables.*

## Connecting to Video Equipment

### Cables used for connection

- Video Cable (BNC x 3, BNC x 1)
- SCART-VGA Cable
- DVI Cable
- S-Video Cable

(Cables are not supplied with the projector.)

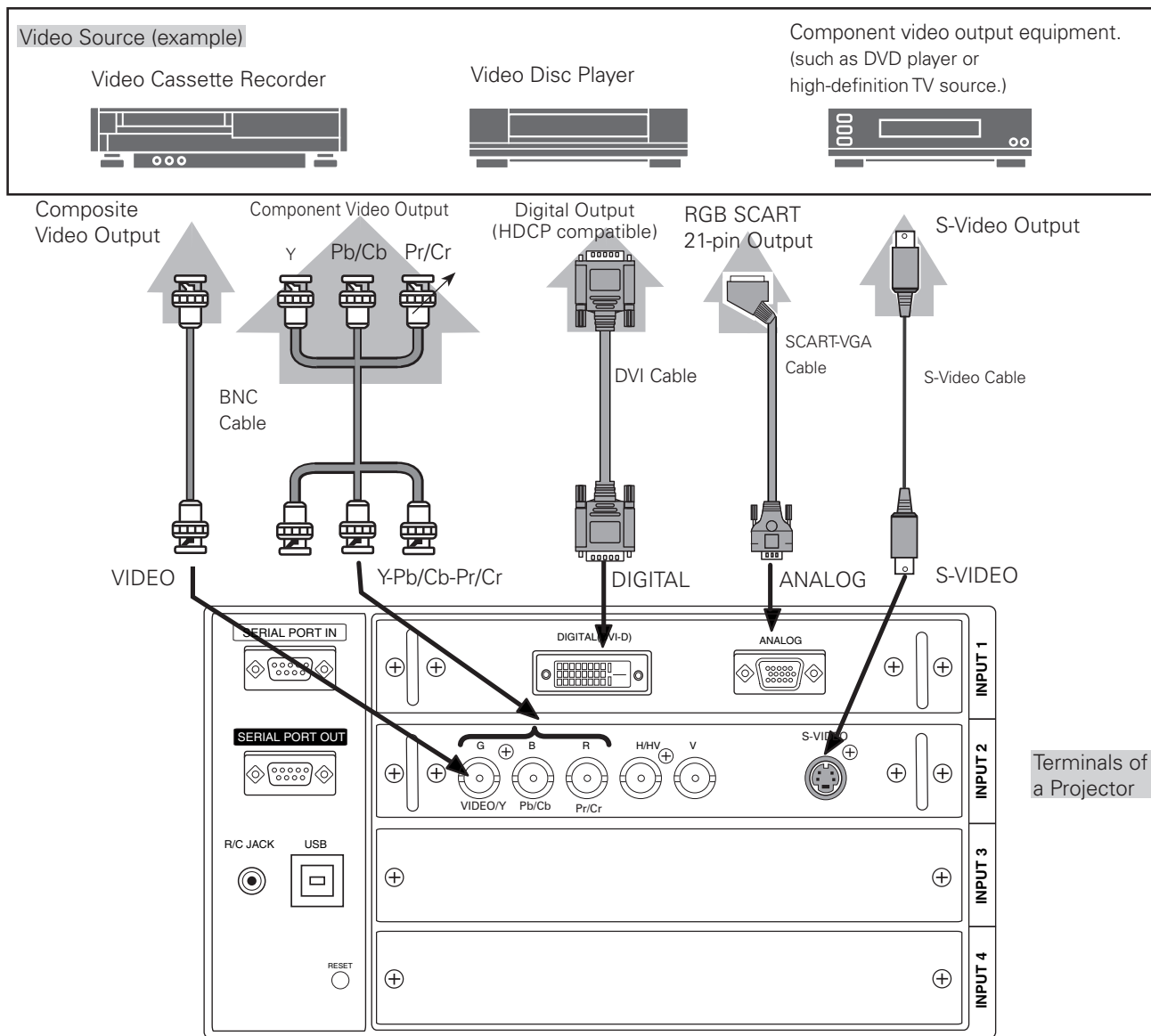

Unplug the power cords of both the projector and external equipment from the AC outlet before connecting cables.

## Connecting the AC Power Cord

This projector uses nominal input voltages of 200–240 V AC. It is designed to work with single-phase power systems having a grounded neutral conductor. To reduce the risk of electrical shock, do not plug into any other type of power system.

If you are not sure of the type of power being supplied, consult your authorized dealer or service station.

Connect the projector with all peripheral equipment before turning on the projector.



### CAUTION

The AC outlet must be near this equipment and must be easily accessible.

#### ✓ Note:

- *Unplug the AC power cord when the projector is not in use. When the projector is connected to an outlet with AC power cord, it is in stand-by mode and consumes a little electric power.*

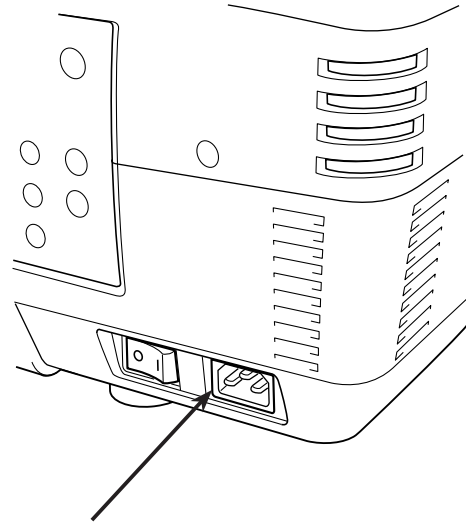

Connect the AC power cord (supplied) to the projector.

### NOTE ON THE POWER CORD

AC power cord must meet the requirements of the country where you use the projector. Confirm the AC plug type with the chart below and proper AC power cord must be used. If the supplied AC power cord does not match your AC outlet, contact your sales dealer.

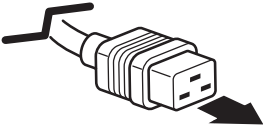
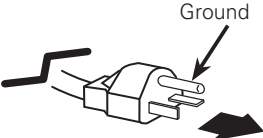
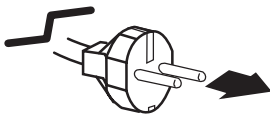
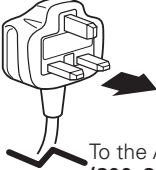
Projector side	AC Outlet side		
 <p>To POWER CORD CONNECTOR on your projector.</p>	<p><b>For the U.S.A. and Canada</b></p>  <p>To the AC Outlet. <b>(240 V AC)</b></p>	<p><b>For Continental Europe</b></p>  <p>To the AC Outlet. <b>(200–240 V AC)</b></p>	<p><b>For the U.K.</b></p>  <p>To the AC Outlet. <b>(200–240 V AC)</b></p>



# Basic Operation

## Turning On the Projector

- 1 Complete peripheral connections (with a computer, VCR, etc.) before turning on the projector.
- 2 Connect the projector's AC power cord into an AC outlet and turn the MAIN ON/OFF Switch to ON. The LAMP indicator lights red and the READY indicator lights green.
- 3 Press the ON/STAND-BY button on the side control or on the remote control. The LAMP indicator dims red and the cooling fans start to operate. The preparation display appears on the screen and the countdown starts.
- 4 After the countdown, the input source that was selected the last time and the Lamp mode icon (see page 56) appear on the screen.

If the projector is locked with a PIN code, PIN code Input Dialog Box will appear. Enter the PIN code as instructed below.

### Enter a PIN code

Use the Point ▲▼ buttons on the side control or on the remote control to enter a number. Press the Point ► button to fix the number and move the red frame pointer to the next box. The number changes to “\*.” Repeat this step to complete entering a four-digit number. After entering the four-digit number, move the pointer to “Set.” Press the SELECT button so that you can start to operate the projector.

If you fixed an incorrect number, use the Point ◀ button to move the pointer to the number you want to correct, and then enter the correct number.

If you entered an incorrect PIN code, “PIN code” and the number (\*\*\*\*) will turn red for a moment. Enter the correct PIN code all over again.

### What is PIN code?

PIN (Personal Identification Number) code is a security code that allows the person who knows it to operate the projector. Setting a PIN code prevents unauthorized use of the projector.

A PIN code consists of a four-digit number. Refer to the PIN code lock function in the Setting Menu on page 52-53 for locking operation of the projector with your PIN code.



The preparation display will disappear after 20 seconds.

### Selected Input Source and Lamp control

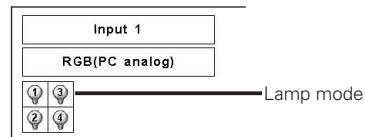

See page 56 for the Lamp control status

### ✓ Note:

- The Lamp replacement icon and the Filter warning icon may appear on the screen depending on the usage state of the projector.

### PIN code Input Dialog Box

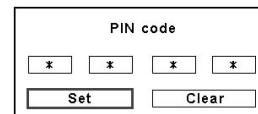

After the OK icon disappears, you can operate the projector.

### ✓ Note:

- When the Logo select function is set to “Off,” the logo will not be shown on the screen (p.48).
- When the “Countdown off” or “Off” is selected in the Display function, the countdown will not be shown on the screen (p.47).
- During the countdown period, all operations are invalid.
- If the correct PIN code number is not entered within three minutes after the PIN code dialog box appeared, the projector will be turned off automatically.
- The “1234” is set as the initial PIN code at the factory.



### CAUTION ON HANDLING PIN CODE

If you forget your PIN code, the projector can no longer be started. Take special care in setting a new PIN code; write down the number in a column on page 75 of this manual and keep it at hand. Should the PIN code be missing or forgotten, consult your dealer or service center.

## Turning Off the Projector

- 1** Press the ON/STAND-BY button on the side control or on the remote control, and "Power off?" appears on the screen.
- 2** Press the ON/STAND-BY button on the side control or on the remote control again to turn off the projector. The LAMP indicator lights bright and the READY indicator turns off. After the projector is turned off, the cooling fans operate for 90 seconds. You cannot turn on the projector during this cooling down period.
- 3** When the projector has cooled down enough, the READY indicator lights green and then you can turn on the projector. To unplug the AC power cord, wait until the projector is completely cooled down.

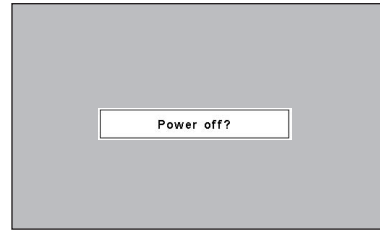

"Power off?" disappears after 4 seconds.



TO MAINTAIN THE LIFE OF THE LAMP, ONCE YOU TURN THE PROJECTOR ON, WAIT AT LEAST FIVE MINUTES BEFORE TURNING IT OFF. DO NOT UNPLUG THE AC POWER CORD WHILE COOLING FANS ARE RUNNING OR BEFORE THE READY INDICATOR LIGHTS GREEN AGAIN. OTHERWISE IT WILL RESULT IN SHORTENING OF THE LAMP LIFE.



DO NOT OPERATE THE PROJECTOR CONTINUOUSLY WITHOUT REST. CONTINUOUS USE MAY RESULT IN SHORTENING THE LAMP LIFE. TURN OFF THE PROJECTOR AND LET STAND FOR ABOUT AN HOUR IN EVERY 24 HOURS.

### ✓ Note:

- When the On start function is set to "On," the projector will be turned on automatically by connecting the AC power cord to an AC outlet (p.51).
- The running speed of cooling fans is changed according to the temperature inside the projector.
- Do not put the projector in a case before the projector is cooled enough.
- If the WARNING TEMP. indicator blinks red, see "Warning Indicators" on page 69.
- The projector cannot be turned on during the cooling period with the READY indicator turned off. You can turn it on again after the READY indicator becomes green again.

## How to Operate the On-Screen Menu

The projector can be adjusted or set via the On-Screen Menu. For each adjustment and setting procedure, refer to the respective sections in this manual.

- 1** Press the MENU button on the side control or the remote control to display the On-Screen Menu.
- 2** Use the Point ◀▶ buttons to select a Menu icon. Use the Point ▲▼ buttons to select an item in the selected menu.
- 3** Press the SELECT button to show the item data. Use the Point ◀▶ buttons to adjust the values.

To close the On-Screen Menu, press the MENU button again.

**✓ Note:**

- The selected item is not active until the SELECT button is pressed.

### Side Control

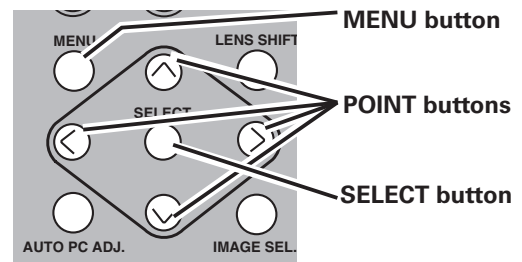

### Remote Control

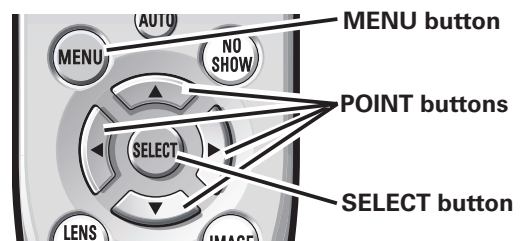

### On-Screen Menu

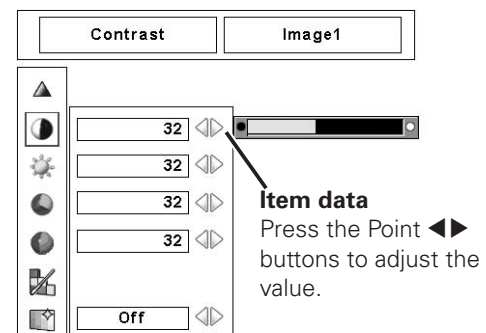
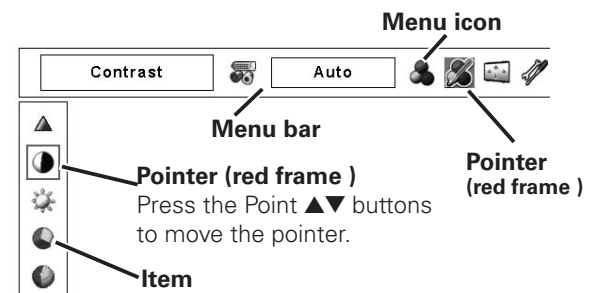

## Menu Bar

For detailed functions of each menu, see "Menu Tree" on pages 65-67.

### For Computer Source

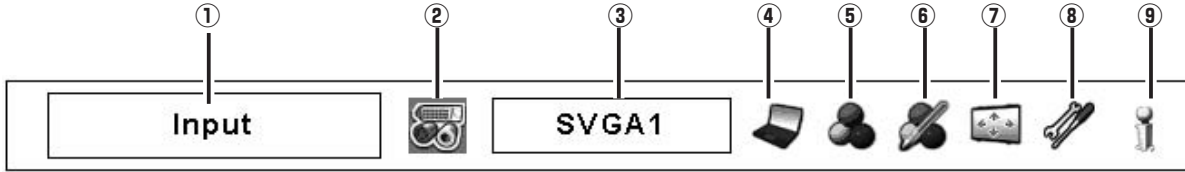

#### ① Guide Window

Show the selected Menu of the On-Screen Menu.

#### ② Input Menu

Used to select an input source Computer or Video (pp. 30-32).

#### ③ PC System Menu

Used to select computer system (p. 33).

#### ④ PC Adjust Menu

Used to adjust the parameters to match with the input signal format (pp. 34-36).

#### ⑤ Image Select Menu

Used to select an image level among Standard, Real, and Image 1-10 (p. 37).

#### ⑥ Image Adjust Menu

Used to adjust the computer image. [Contrast/ Brightness/ Color management/ Auto picture control/ Color temp./ White balance (R/G/B)/ Offset (R/G/B)/ Sharpness/ Gamma/ Reset/ Store/ Quit] (pp. 44-46).

#### ⑦ Screen Menu

Used to adjust the size of the image. [Normal/ True/ Wide/ Full screen/ Custom/ Keystone/ Ceiling/ Rear/ Reset/ Digital zoom +/-] (pp. 38-39).

#### ⑧ Setting Menu

Used to set the projector's operating configurations (pp. 47-54).

#### ⑨ Information Menu

Display the input source information (p. 28).

### For Video Source

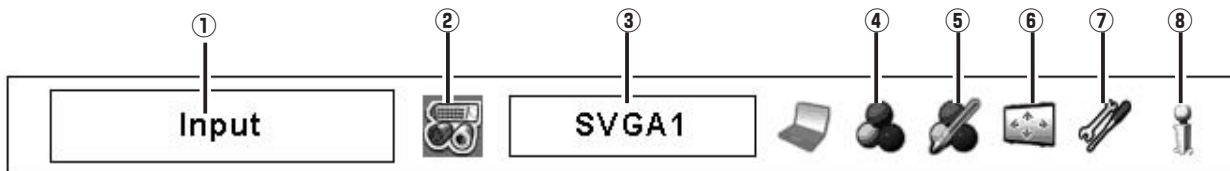

#### ① Guide Window

Show the selected Menu of the On-Screen Menu.

#### ② Input Menu

Used to select an input source Computer or Video (pp. 30-32).

#### ③ AV System Menu

Used to select the system of selected video source (p. 40).

#### ④ Image Select Menu

Used to select an image level among Standard, Cinema, and Image 1-10 (p. 41).

#### ⑤ Image Adjust Menu

Used to adjust the picture image. [Contrast/ Brightness/ Color/ Tint/ Color management/ Auto picture control/ Color temp./ White balance (R/G/B)/ Offset (R/G/B)/ Sharpness/ Gamma/ Noise reduction/ Progressive/ Reset/ Store/ Quit] (pp. 44-46)

#### ⑥ Screen Menu

Used to adjust the size of the image. [Normal/ Wide/ Custom/ Keystone/ Ceiling/ Rear/ Reset] (pp. 42-43).

#### ⑦ Setting Menu

Used to set the projector's operating configurations (pp. 47-54).

#### ⑧ Information Menu

Display the input source information (p. 28).

## Operating with Projector Control

### Zoom Adjustment

Display "Zoom" on the screen. Use the ZOOM ▲▼ buttons to zoom in and out the image.

### Focus Adjustment

Display "Focus" on the screen. Use the FOCUS ▲▼ buttons to adjust focus of the image.

### Lens Shift Adjustment

Display "Lens shift" on the screen. Use the Point ▲▼◀▶ buttons to position the screen to the desired point without having picture distortion.

The screen can be moved up or down to 50 percent, or sideways up to 10 percent from the central axis of the lens shift.

### Auto PC Adjustment

Operate the Auto PC Adj. function. The computer screen adjustment can be done easily by pressing this button.

See page 34 for details.

### Image Level Selection

Press the IMAGE SEL. button to select a desired image level of the screen.

For more detail, see p37, 41.

✓ **Note:**

- The arrow disappears at the maximum lens shift in each direction.
- The arrow turns red when the lens shift comes to the center position of the screen.

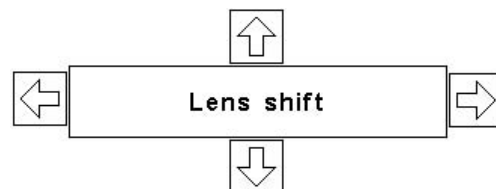
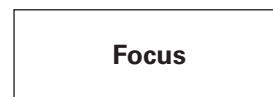
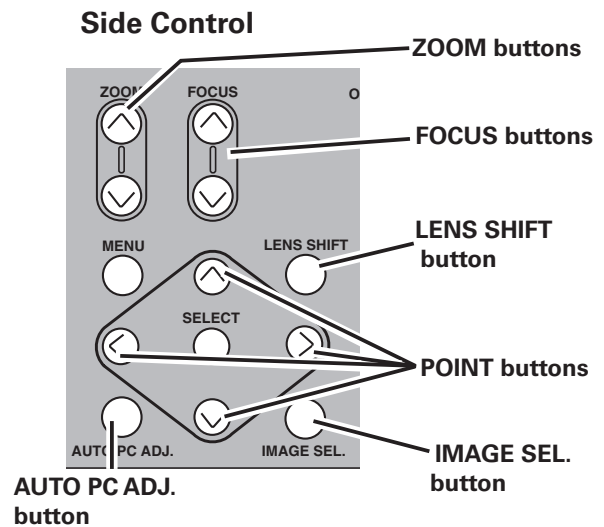

## Operating with Remote Control

Using the remote control for some frequently used operations is advisable. Just pressing one of the buttons enables you to make the desired operation quickly without calling up the On-Screen Menu.

### AUTO PC button

Press the AUTO PC button on the remote control to operate the Auto PC Adj. function. The computer screen adjustment can be done easily by pressing this button. See page 34 for details.

### LENS SHIFT button

See page 27 for details.

### ZOOM buttons

Press the ZOOM buttons on the remote control to zoom in and out the image.

### FOCUS buttons

Press the FOCUS buttons on the remote control to adjust focus of the image.

### FREEZE button

Press the FREEZE button on the remote control to freeze the picture on the screen. To cancel the FREEZE function, press the FREEZE button again or press any other button.

### SCREEN button

Press the SCREEN button on the remote control to select the desired screen size. The selected screen size symbol appears on the screen for 4 seconds. See pages 38 to 39 and 42 to 43 for details.

Press and hold the SCREEN button for more than 5 seconds to return all the screen size adjustment setting to the factory default setting.

### D.ZOOM button

Press the D.ZOOM button on the remote control to enter to the Digital zoom +/- mode. See page 39 for details.

### INFO. button

Information display can be used to confirm the current operating condition of the projector and the signal being projected through the projector.

Press the INFO. button on the remote control to display the information window on the screen. To hide the information window, press the INFO. button again or Point ◀▶ buttons.

The information window can also be selected from the menu.

## Remote Control

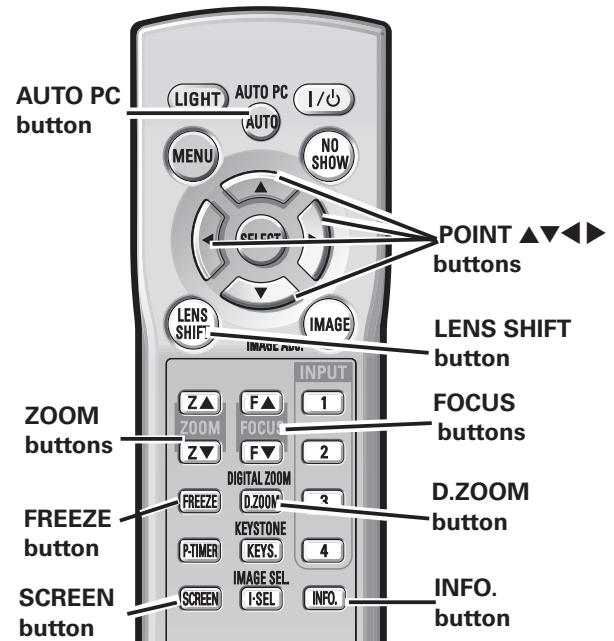

### ✓ Note:

- See the next page for the description of other buttons.

## Information Menu



Input	Input 1
	RGB(PC analog)
H-sync freq.	0.0 KHz
V-sync freq.	0.0 Hz
Screen	Normal
Language	English
Lamp mode	⬤⬤
Lamp control	⬤
Power management	Ready 5 Min
Security	Keylock
	PIN code lock Off
Remote control	Code 1

Option control No. 9

\* The H- and V-sync freq. values described in this figure may be different from the actual values.

## NO SHOW button

Press the NO SHOW button on the remote control to black out the image. To restore to normal, press the NO SHOW button again or press any other button.

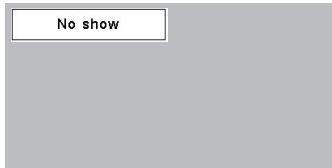

"No show" disappears after 4 seconds.

## IMAGE ADJ. button

Press the IMAGE ADJ. button on the remote control to adjust a image level of the screen.  
For more detail, see pp.44-46.

## IMAGE SEL. button

Press the IMAGE SEL. button on the remote control to select a desired image level of the screen.  
For more detail, see pp.37, 41.

## P-TIMER button

Press the P-TIMER button on the remote control. The Timer display "00 : 00" appears on the screen and starts to count time (00 : 00-59 : 59).  
To stop the P-TIMER, press the P-TIMER button.  
To cancel the P-TIMER, press the P-TIMER button again.

## Remote Control

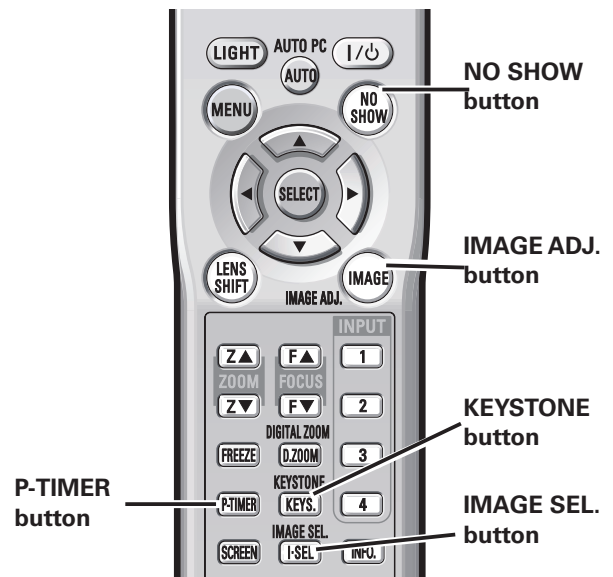

### ✓ Note:

- See the previous page for the description of other buttons.



P-Timer display

## KEYSTONE button

Press the KEYSTONE button on the remote control. The "Keystone" appears on the screen.

Use the Point ▲▼◀▶ buttons to correct keystone distortion. The keystone adjustment can be stored (pp.39, 43).

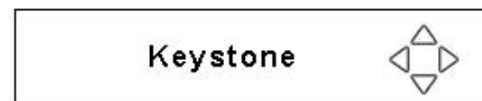

- The white arrows indicate that there is no correction.
- A red arrow indicates the direction of correction.
- An arrow disappears at the maximum correction.
- If you press the KEYSTONE button on the remote control again while the Keystone dialog box is being displayed, the keystone adjustment will be canceled.
- "Keystone" disappears after 10 seconds.

Reduce the upper width with Point ▲ button.

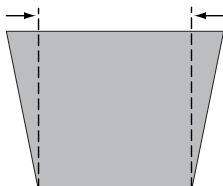

Reduce the lower width with Point ▼ button.

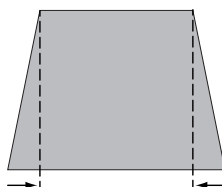

Reduce the left part with Point ◀ button.

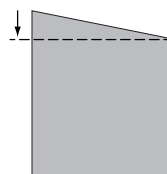

Reduce the right part with Point ▶ button.

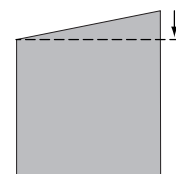



# Input Selection

## Input

### Side Control

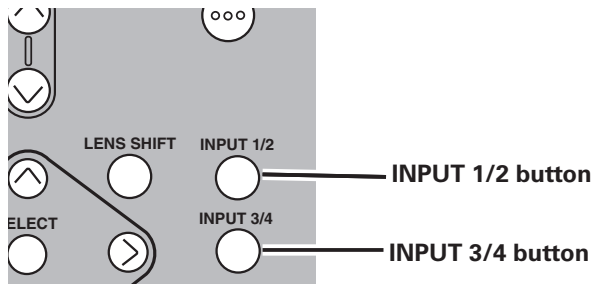

### Side Control button operation

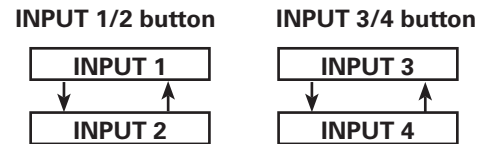

### Side Control Operation

Press the INPUT 1/2 or INPUT 3/4 button on the side control. It switches to INPUT 1 and INPUT 2, or INPUT 3 and INPUT 4 as you press the INPUT button.

Before using the INPUT button on the side control, you must select a correct input source by On-Screen Menu and the latest input source will be displayed.

### Remote Control

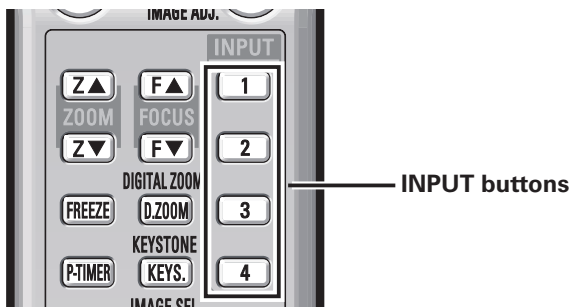

### Remote Control button operation

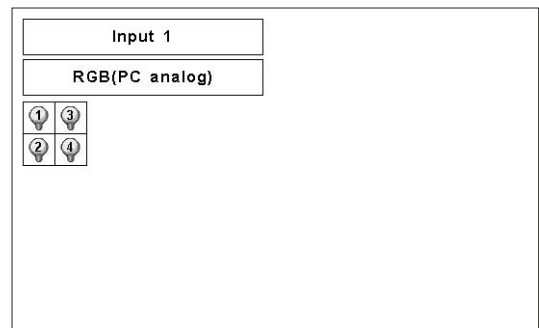

### Remote Control Operation

Press the INPUT 1, INPUT 2, INPUT 3 or INPUT 4 buttons on the remote control. It switches to INPUT 1, INPUT 2, INPUT 3 or INPUT 4 as you press the INPUT button.

Before using the INPUT button on the remote control, you must select a correct input source by On-Screen Menu and the latest input source will be displayed.

✓ **Note:**

- Empty slots can not be selected.
- When a slot is empty, the input is displayed in grayout.

## Computer Input Source Selection

### Menu Operation

#### When Selecting the INPUT 1 with DVI/D-sub 15 Board

- 1** Press the MENU button to display the On-Screen Menu. Use the Point ◀▶ buttons to move the red frame pointer to the INPUT Menu icon.
- 2** Use the Point ▲▼ buttons to move the red arrow pointer to the desired input and then press the SELECT button. The Source Select Menu appears.
- 3** Use the Point ▲▼ buttons to select the desired source and then press the SELECT button.

#### RGB (PC analog)

When your computer is connected to the INPUT 1 (ANALOG) terminal, select RGB (PC analog).

#### RGB (PC digital)

When your computer is connected to INPUT 1 (DIGITAL) terminal, select RGB (PC digital).

#### INPUT MENU

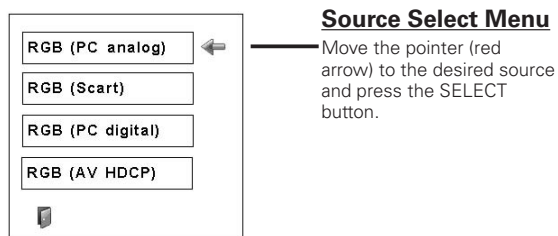
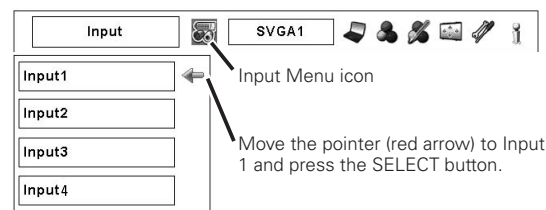

#### ✓ Note:

- *HDCP (High-bandwidth Digital Content Protection) is a system for protecting digital entertainment content which is delivered by DVI (Digital Visual Interface) from being copied. The specification of HDCP is decided and controlled by Digital Content Protection, LLC. Should the specification be changed, this projector may not display the digital content protected by HDCP.*

#### When Selecting the INPUT 2 with 5-BNC/Video Board

When connecting the computer output [5 BNC Type (Green, Blue, Red, Horiz. Sync, and Vert. Sync.)] from the computer to G, B, R, H/HV, and V jacks:

#### RGB

When your computer is connected to the INPUT 2 (5 BNC INPUT JACKS) terminal, select RGB.

#### INPUT MENU

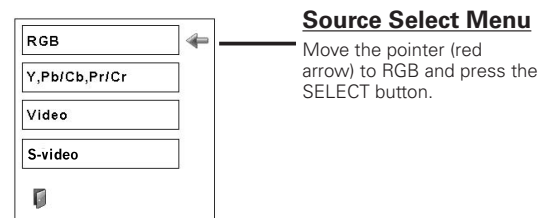
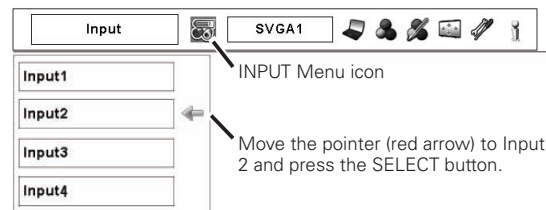

## Video Input Source Selection

### Menu Operation

#### When Selecting the INPUT 1 with DVI/D-sub 15 Board

When connecting to video equipment, select the type of Video source in the Source Select Menu.

##### RGB (Scart)

When scart video equipment is connected to the INPUT 1 (ANALOG) terminal, select RGB (Scart).

##### RGB (AV HDCP)

If the HDCP-compatible signal source is connected to the INPUT 1 (DIGITAL) terminal, select RGB (AV HDCP).

#### INPUT MENU

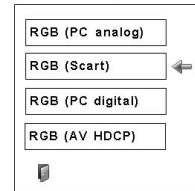
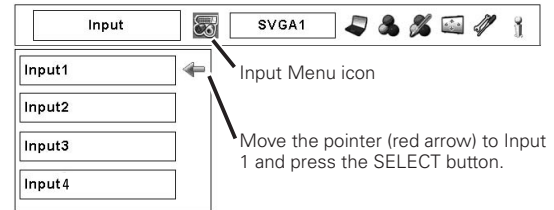

#### When Selecting the INPUT 2 with 5-BNC/Video Board

When connecting to video equipment, select the type of Video source in the Source Select Menu.

##### Y, Pb/Cb, Pr/Cr

When the video input signal is connected to the Y-Pb/Cb-Pr/Cr jacks, select Y, Pb/Cb, Pr/Cr.

##### Video

When the video input signal is connected to the VIDEO jack, select Video.

##### S-Video

When the video input signal is connected to the S-VIDEO jack, select S-Video.

#### INPUT MENU

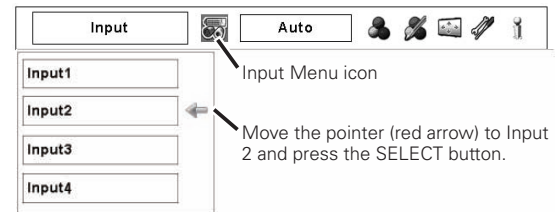

# Computer Input

## Computer System Selection

### Automatic Multi-Scan System

This projector automatically tunes to various types of computers based on VGA, SVGA, XGA, SXGA, SXGA+, WXGA, or UXGA (refer to "Compatible Computer Specifications" on pages 70–71). If a computer is selected as a signal source, this projector automatically detects the signal format and tunes to project a proper image without any additional settings. (Some computers need to be set manually.)

One of the following messages may appear when:

**Auto** The projector cannot recognize the connected signal conforming to the provided PC Systems. The "Auto" is displayed on the PC System Menu icon and the Auto PC Adjustment function works to display proper images. If the image is not projected properly, a manual adjustment is required. (pp. 36–37.)

**-----** There is no signal input from the computer. Check the connection between your computer and the projector. (See "Troubleshooting" on page 64.)

**Mode 1** The preset system is manually adjusted in the PC Adjust Menu. The adjusted data can be stored in the Mode 1–10. (pp. 36-37)

**SVGA 1** PC systems provided in this projector is chosen. The projector chooses a proper system provided in the projector and displays it.

\* Mode 1 and SVGA 1 are examples.

### Selecting Computer System Manually

PC system can also be selected manually.

- 1 Press the MENU button to display the On-Screen Menu. Use the Point ◀▶ buttons to move the red frame pointer to the PC System Menu icon.
- 2 Use the Point ▲▼ buttons to move the red arrow pointer to the desired system, and then press SELECT button.

#### PC SYSTEM MENU

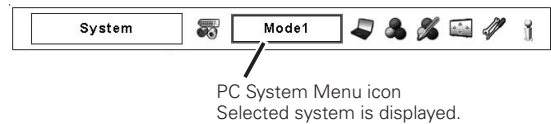

#### PC SYSTEM MENU

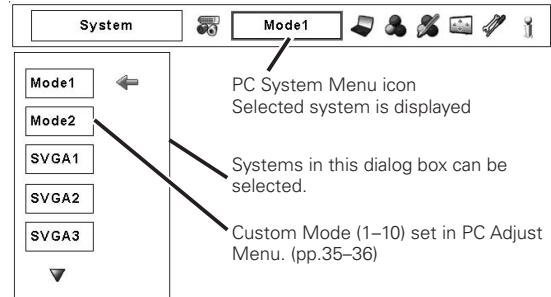

## Auto PC Adjustment

Auto PC Adjustment function is provided to automatically adjust Fine sync, Total dots, Horizontal and Vertical positions to conform to your computer.

### Direct Operation

The Auto PC adjustment function can be operated directly by pressing the AUTO PC button on the remote control or the AUTO PC ADJ. button on the side control.

### Remote Control

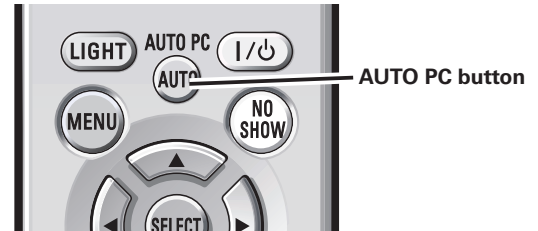

### Side Control

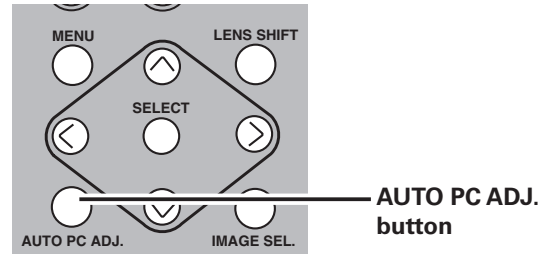

### Menu Operation



#### Auto PC adj.

- 1 Press the MENU button to display the On-Screen Menu. Use the Point ◀▶ buttons to move the red frame pointer to the PC Adjust Menu icon.
- 2 Use the Point ▲▼ buttons to move the red frame pointer to the AUTO PC adj. icon and then press the SELECT button twice.

#### To store the adjusted parameters.

The adjusted parameters from the Auto PC Adjustment can be stored in the projector. Once the parameters are stored, the setting can be done just by selecting Mode in PC SYSTEM Menu (p.34). See MANUAL PC ADJUSTMENT on pages 35–36.

#### ✓ Note:

- Fine sync, Total dots, Horizontal and Vertical position of certain computers cannot be fully adjusted with the Auto PC Adjustment function. When the image is not provided properly with this operation, manual adjustments are required. (pp. 35–36.)
- Auto PC Adjustment cannot be operated in Digital Signal Input on the DVI terminal and "480p," "575p," "480i," "575i," "720p," "1035i," or "1080i" is selected on the PC SYSTEM Menu.
- Depending on the condition of signals and the type and length of cables, the signals may not be properly viewed.

### PC ADJUST MENU

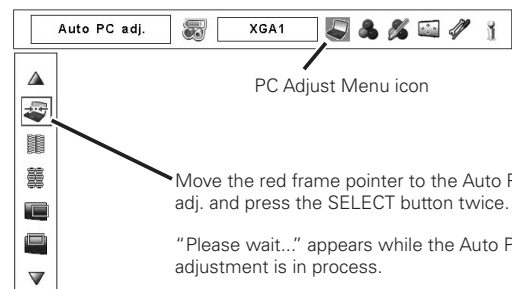

## Manual PC Adjustment

Some computers employ special signal formats which may not be tuned by Multi-Scan system of this projector. Manual PC Adjustment enables you to precisely adjust several parameters to match those special signal formats. The projector has 10 independent memory areas to store those parameters manually adjusted. It allows you to recall the setting for a specific computer.

**✓ Note:** The PC Adjust Menu cannot be operated when the digital signal input on the DVI terminal is selected on PC System Menu.

- 1** Press the MENU button to display the On-Screen Menu. Use the Point ◀▶ buttons to move the red frame pointer to the PC Adjust Menu icon.
- 2** Use the Point ▲▼ buttons to move the red frame pointer to the desired item and then press the SELECT button to display the adjustment dialog box. Use the Point ◀▶ buttons to adjust the setting value.

### Fine sync

Use the Point ◀▶ buttons to adjust the value, eliminating a flicker from the image displayed (from 0 to 31).

### Total dots

Use the Point ◀▶ buttons to adjust the number of total dots in one horizontal period to match your PC image.

### Position H

Use the Point ◀▶ buttons to adjust the horizontal picture position.

### Position V

Use the Point ◀▶ buttons to adjust the vertical picture position.

### Current mode

Press the SELECT button to show H-sync freq. and V-sync freq. of the connected computer.

### Clamp

Use the Point ◀▶ buttons to adjust the clamp level. When the image has dark bars, try this adjustment.

### Display area H

Use the Point ◀▶ buttons to adjust the horizontal area displayed by this projector.

### Display area V

Use the Point ◀▶ buttons to adjust the vertical area displayed by this projector.

## PC ADJUST MENU

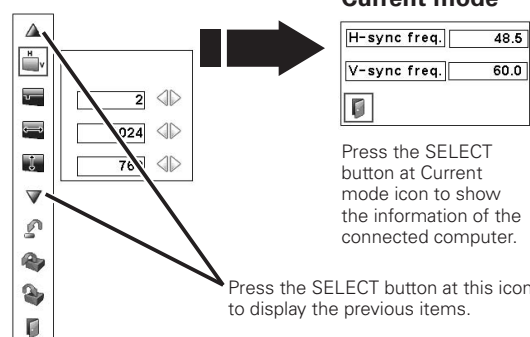
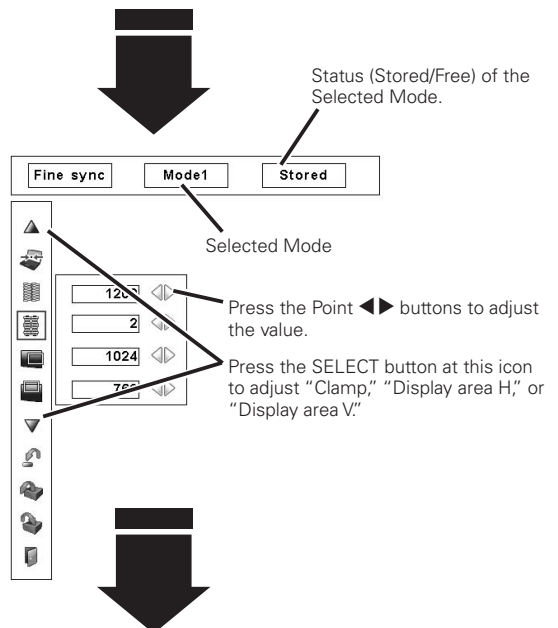
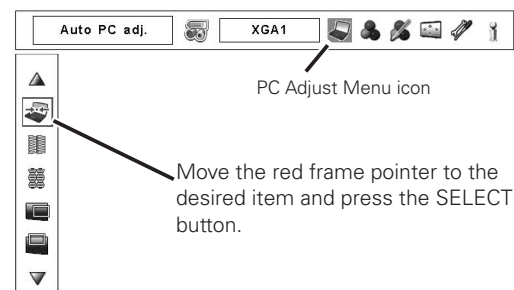

# Computer Input



## Reset

To reset the adjusted data, select Reset and press the SELECT button. A confirmation box appears and then select [Yes]. All adjustments will return to their previous figures.



## Mode free

To clear the adjusted data, select Mode free and then press the SELECT button. Move the red arrow pointer to the Mode that you want to clear and then press the SELECT button.



## Store

To store the adjusted data, select Store and then press the SELECT button. Move the red arrow pointer to one of the Mode 1 to 10 in which you want to store, and then press the SELECT button.



## Quit

Exit the PC Adjust Menu.

### To clear the adjusted data.

Where to free?

Mode1	Stored	0	0	0	0	0	0
Mode2	Free	0	0	0	0	0	0
Mode3	Free	0	0	0	0	0	0
Mode4	Free	0	0	0	0	0	0
Mode5	Free	0	0	0	0	0	0

OK?

Yes

No

Close this dialog box.

Confirmation box appears and then select [Yes].

### To store the adjusted data.

Where to store?

Mode1	Stored	0	0	0	0	0	0
Mode2	Free	0	0	0	0	0	0
Mode3	Free	0	0	0	0	0	0
Mode4	Free	0	0	0	0	0	0
Mode5	Free	0	0	0	0	0	0

This Mode has stored parameters.

Vacant

Close this dialog box.

Values of "Total dots," "Position H," "Position V," "Display area H," and "Display area V."

OK?

Yes

No

Confirmation box appears and then select [Yes].



## Image Level Selection

### Direct Operation

Press the IMAGE SEL. button on the remote control or on the side control to select the desired image level.

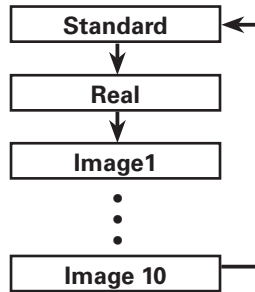

### Side Control

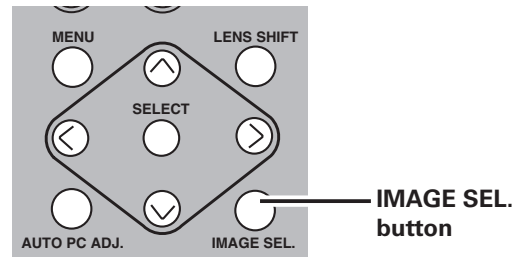

### Remote Control

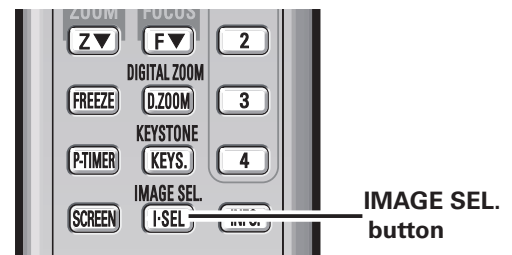

### Menu Operation

- 1** Press the MENU button to display the On-Screen Menu. Use the Point ◀▶ buttons to move the red frame pointer to the Image Select Menu icon.
- 2** Use the Point ▲▼ buttons to move the red frame pointer to the desired image level and then press the SELECT button.



Normal picture level preset on the projector.



Picture level with improved halftone for graphics.



User preset picture adjustment in the Image Adjust Menu. (p. 46)

### IMAGE SELECT MENU

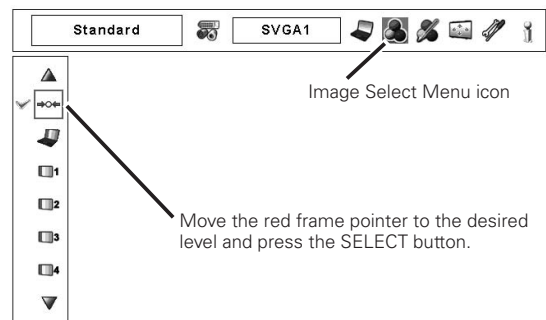

## Screen Size Adjustment

Select the desired screen size that conforms to the input signal source.

- 1 Press the MENU button to display the On-Screen Menu. Use the Point ◀▶ buttons to move the red frame pointer to the Screen Menu icon.
- 2 Use the Point ▲▼ buttons to move the red frame pointer to the desired function and then press the SELECT button.



### Normal

Provide the image at the normal computer aspect ratio of 4:3.



### True

Provide the image in its original size. When the original image size is larger than the screen size (1024 x 768), the projector enters to the panning mode automatically. Use the Point ▲▼◀▶ buttons to pan the image. When adjusted, the arrows will turn red. When reached to the correction limits, the arrows will disappear.



### Wide

Provide the image to fit the wide video aspect ratio (16:9) by expanding the image width uniformly. This function can be used to provide the squeezed video signal at 16:9.



### Full screen

Provides the full screen image.



### Custom

Adjust the screen scale and position manually with this function.

Press the SELECT button at Custom and the "Custom" is displayed on the screen for a few seconds. To display the Aspect dialog box, press the SELECT button at Custom again and then the Aspect dialog box appears.

- Scale H/V ..... Adjust the Horizontal/Vertical screen scale.
- H&V ..... When set to "On," the aspect ratio is fixed. The "Scale V" appears dimmed and becomes unavailable. Adjust "Scale H," then the screen scale is automatically modified based on the aspect ratio.
- Position H/V ..... Adjust the Horizontal/Vertical screen position.
- Common ..... Save the adjusted scale to all the inputs. Press the SELECT button at Common to display a confirmation box. To save the scale, press the SELECT button at "Yes." When Custom is selected, the saved scale is used.
- Reset ..... Reset the all adjusted values. Press the SELECT button at Reset to display a confirmation box. To reset, press the SELECT button at "Yes."

### SCREEN MENU

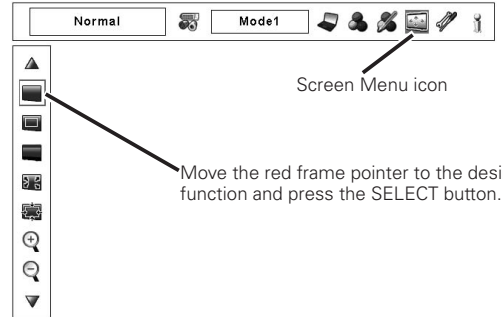

#### ✓ Note:

- True, Full screen, and Digital zoom +/- cannot be selected when no signal is detected in the PC System Menu. (p.33)
- The projector cannot display and resolution higher than 1600 x 1200. If your computer's screen resolution is higher than 1600 x 1200, lower the resolution before connecting the projector.
- The image data other than XGA (1024 x 768) is modified to fit the screen size in initial mode.
- The panning function may not operate properly if the stored Mode in the PC Adjust Menu is used. (p. 36)

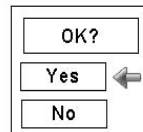
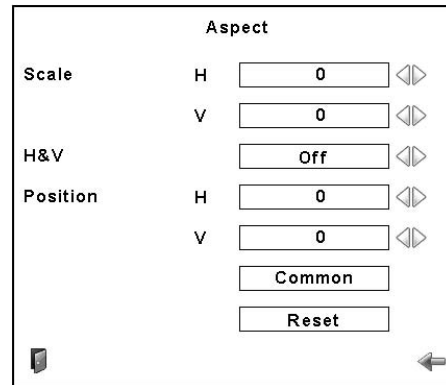

Press the SELECT button at Common or Reset, to display a confirmation box.

#### ✓ Note:

- When no signal is detected, "Normal" is set automatically and the Aspect dialog box disappears.
- The adjustable range for Scale H/V and Position H/V is limited depending on the input signal.



## Keystone

This function is used to store or reset the keystone correction when the AC power cord is unplugged. Use the Point ◀▶ buttons to switch between each option.

Store . . . Keep the keystone correction even when the AC power cord is unplugged.

Reset . . . Release the keystone correction when the AC power cord is unplugged.

To correct keystone distortion, press the Select button. The Keystone dialog box appears. Use the Point ▲▼◀▶ buttons to correct keystone distortion. (p.29)



## Ceiling

When this function is set to "On," the picture is top/bottom and left/right reversed. This function is used to project the image from a ceiling-mounted projector.



## Rear

When this function is set to "On," the picture is left/right reversed. This function is used to project the image from the rear of the screen.



## Reset

This function returns all adjusted values to the factory default settings. Press the SELECT button at Reset to display a confirmation box. To reset, press the SELECT button at "Yes."



## Quit

Exit the Screen Size Adjustment Menu.

## For zooming in and out the images



## Digital zoom +

Select Digital zoom +. The On-Screen Menu disappears and "D. zoom +" appears. Press the SELECT button to expand the image size. Use the Point ▲▼◀▶ buttons to pan the image. The Panning function can work only when the image is larger than the screen size.

You can also enter the Digital zoom + mode by pressing the D.ZOOM button on the remote control.



## Digital zoom -

Select Digital zoom -. The On-Screen Menu disappears and "D.Zoom -" appears. Press the SELECT button to compress the image size.

You can also enter the Digital zoom - mode by pressing the D.ZOOM button on the remote control.

To exit the Digital Zoom +/- mode, press any button except the D.ZOOM, SELECT, and Point buttons.

## SCREEN MENU

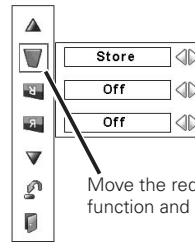

Move the red frame pointer to the desired function and press the SELECT button.

## Ceiling

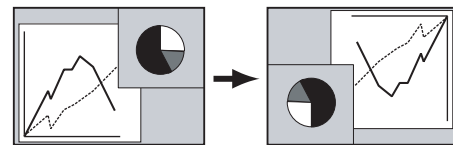

## Rear

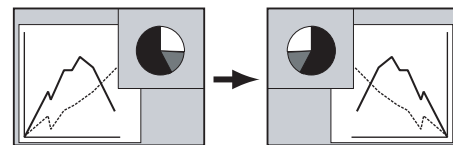

## ✓ Note:

- The panning function may not operate properly if the stored Mode in the PC Adjust Menu is used. (p. 36)
- The minimum compression ratio can be limited depending on the input signal or when the Keystone function is working.
- Digital zoom +/- cannot be selected when Full screen or True is selected.

# Video Input

## Video System Selection

- 1 Press the MENU button to display the On-Screen Menu. Use the Point ◀▶ buttons to move the red frame pointer to the AV System Menu icon.
- 2 Use the Point ▲▼ buttons to move the red arrow pointer to the desired system and then press the SELECT button.

## Video Jack or S-Video Jack

### Auto

The projector automatically detects an incoming video system, and adjusts itself to optimize its performance.

### PAL/SECAM/NTSC/NTSC4.43/PAL-M/PAL-N

If the projector cannot reproduce proper video image, select a specific broadcast signal format from among PAL, SECAM, NTSC, NTSC 4.43, PAL-M, and PAL-N.

### AV SYSTEM MENU (VIDEO OR S-VIDEO)

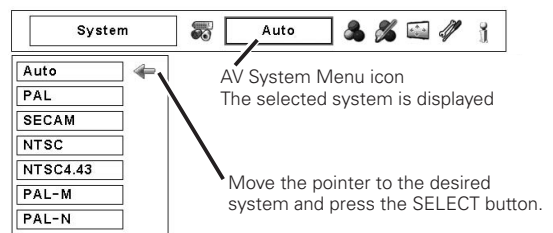

## Y, Pb/Cb, Pr/Cr Jacks

### Auto

The projector automatically detects an incoming video signal, and adjusts itself to optimize its performance.

When the Video System is 1035i or 1080i, select the system manually.

### COMPONENT VIDEO SIGNAL FORMAT

If the projector cannot reproduce proper video image, select a specific component video signal format from among 480i, 575i, 480p, 575p, 720p, 1035i, and 1080i.

### AV SYSTEM MENU (COMPONENT VIDEO)

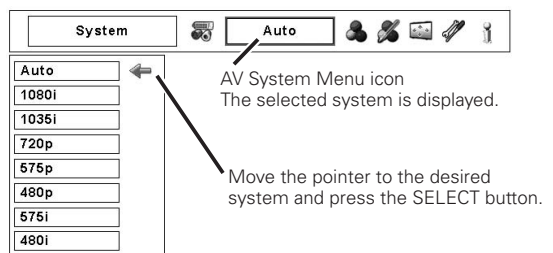

### ✓ Note:

- The AV System menu cannot be selected when selecting RGB(Scart).

## Image Level Selection

### Direct Operation

Press the IMAGE SEL. button on the remote control or on the side control to select the desired image level.

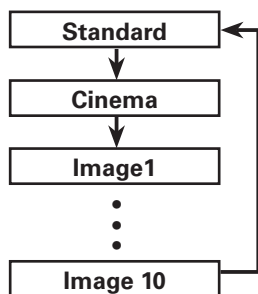

### Side Control

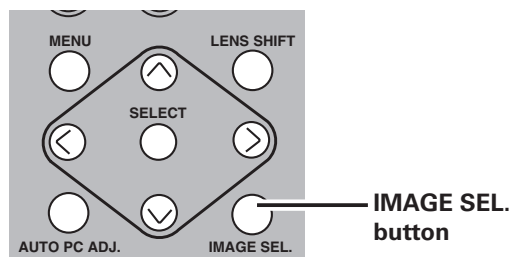

### Remote Control

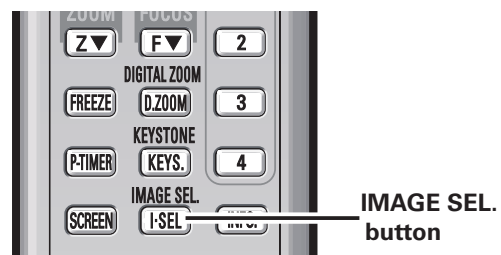

### Menu Operation

- 1** Press the MENU button to display the On-Screen Menu. Use the Point ◀▶ buttons to move the red frame pointer to the Image Select Menu icon.
- 2** Use the Point ▲▼ buttons to move the red frame pointer to the desired image level and then press the SELECT button.



**Standard**

Normal picture level preset on the projector.



**Cinema**

Picture level adjusted with fine tone.



**IMAGE 1-10**

User preset picture adjustment in the Image Adjust Menu. (p. 46)

### IMAGE SELECT MENU

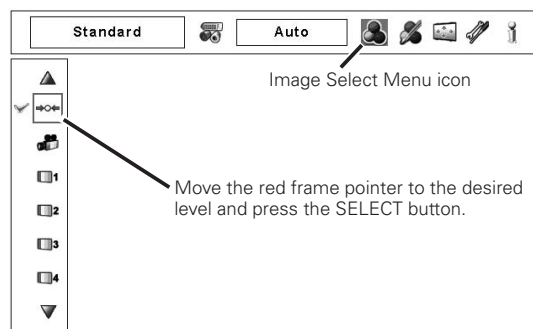

## Screen Size Adjustment

- 1 Press the MENU button to display the On-Screen Menu. Use the Point ◀▶ buttons to move the red frame pointer to the Screen Menu icon.
- 2 Use the Point ▲▼ buttons to move the red frame pointer to the desired function and then press the SELECT button.



### Normal

Provide the image at the normal video aspect ratio of 4:3.



### Wide

Provide the image at the wide screen ratio of 16:9.



### Custom

Adjust the screen scale and position manually with this function.

Press the SELECT button at Custom and the "Custom" is displayed on the screen for a few seconds. To display the Aspect dialog box, press the SELECT button at Custom again and then the Aspect dialog box appears.

- Scale H/V ..... Adjust the Horizontal/Vertical screen scale.
- H&V ..... When set to "On," the aspect ratio is fixed. The "Scale V" appears dimmed and becomes unavailable. Adjust "Scale H," then the screen scale is automatically modified based on the aspect ratio.
- Position H/V ..... Adjust the Horizontal/Vertical screen position.
- Common ..... Save the adjusted scale to all the inputs. Press the SELECT button at Common to display a confirmation box. To save the scale, press the SELECT button at "Yes." When Custom is selected, the saved scale is used.
- Reset ..... Reset the all adjusted values. Press the SELECT button at Reset to display a confirmation box. To reset, press the SELECT button at "Yes."

### SCREEN MENU

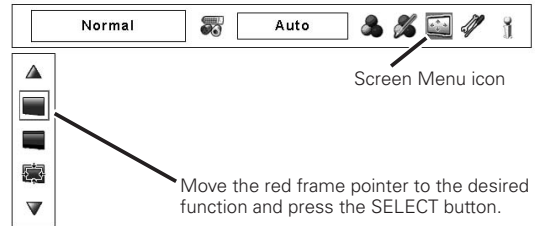

#### ✓ Note:

- Wide cannot be operated when "720p," "1035i," or "1080i" is selected on AV System Menu (p.40).

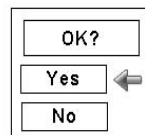
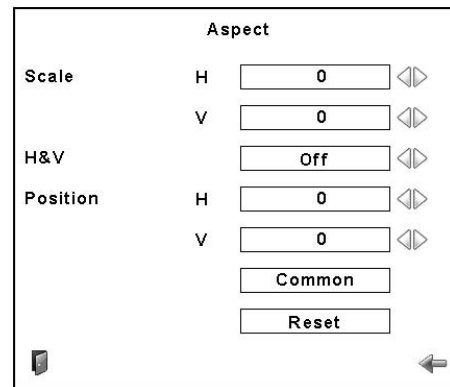

Press the SELECT button at Common or Reset, to display a confirmation box.

#### ✓ Note:

- When no signal is detected, "Normal" is set automatically and the Aspect dialog box disappears.
- The adjustable range for Scale H/V and Position H/V is limited depending on the input signal.



## Keystone

This function is used to store or reset the keystone correction when the AC power cord is unplugged. Use the Point ◀▶ buttons to switch between each option.

Store . . . Keep the keystone correction even when the AC power cord is unplugged.

Reset . . . Release the keystone correction when the AC power cord is unplugged.

To correct keystone distortion, press the Select button. The Keystone dialog box appears. Use the Point ▲▼◀▶ buttons to correct keystone distortion. (p.29)



## Ceiling

When this function is set to "On," the picture is top/bottom and left/right reversed. This function is used to project the image from a ceiling-mounted projector.



## Rear

When this function is set to "On," the picture is left/right reversed. This function is used to project the image from the rear of the screen.



## Reset

This function returns all adjusted values to the factory default settings. Press the SELECT button at Reset to display a confirmation box. To reset, press the SELECT button at "Yes."



## Quit

Exit the Screen Size Adjustment Menu.

## SCREEN MENU

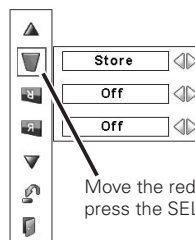

Move the red frame pointer to a function and press the SELECT button.

## Ceiling

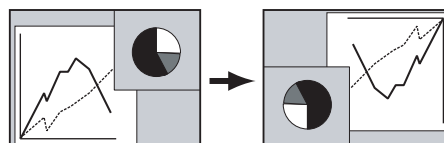

## Rear

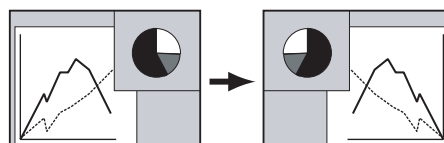

# Picture Image

## Image Adjustment

- 1 Press the MENU button to display the On-Screen Menu. Use the Point ◀▶ buttons to move the red frame pointer to the Image Adjust Menu icon.
- 2 Use the Point ▲▼ buttons to move the red frame pointer to the desired item and then press the SELECT button to display the adjustment dialog box. Use the Point ◀▶ buttons to adjust the setting value.



### Contrast

Press the Point ◀ button to decrease contrast; press the Point ▶ button to increase the contrast (from 0 to 63).



### Brightness

Press the Point ◀ button to decrease the brightness; press the Point ▶ button to increase the brightness (from 0 to 63).



### Color \*

Press the Point ◀ button to decrease the intensity of the color; press the Point ▶ button to increase the intensity of the color (from 0 to 63).



### Tint \*

Press the Point ◀▶ buttons to adjust the tint value to obtain proper color balance (from 0 to 63).



### Color Management

The Color Management function can be used to adjust the LEVEL, PHASE, and GAMMA of the selected display colors (except for black, white, and gray) on the screen and replace these colors with other colors if required.

You can store up to eight (8) color management data.

- 1 Use the Point ▲▼ buttons to move the red frame pointer to Color Management, and then press the SELECT button. The projected image freezes, and the COLOR MANAGEMENT POINTER appears.
- 2 Use the Point ▲▼◀▶ buttons to move the pointer to the spot where you want to adjust the color and then press the SELECT button. The COLOR SELECTION window appears, and the color in the center of the pointer is selected and you can adjust the color.
- 3 Use the Point ▲▼◀▶ buttons to adjust the LEVEL and PHASE of the color, and then press the SELECT button to confirm the setting. Then use the Point ▲▼ buttons to adjust the GAMMA for the color and press the SELECT button to accept the setting. After adjusting, press the SELECT button to go to the COLOR MANAGEMENT LIST.

## COLOR SELECTION MODE

### LIST

Go to the COLOR MANAGEMENT LIST.

## IMAGE ADJUST MENU

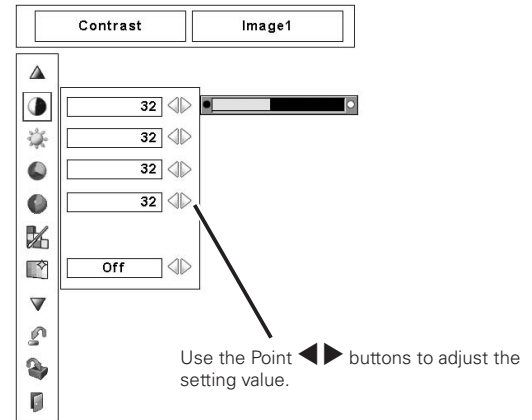
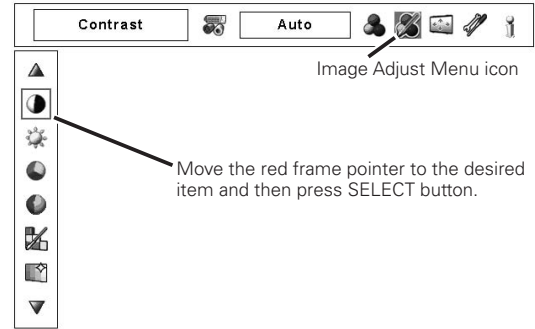

## POINTER MODE

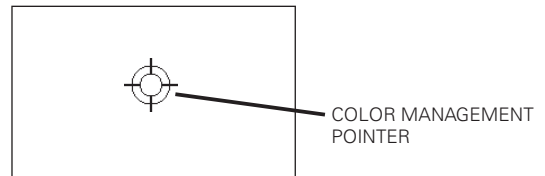

### ✓ Note:

- \* Displayed only in Video Input.
- Tint cannot be selected when the video system is PAL, SECAM, PAL-M, or PAL-N (p.40).



COLOR SELECTION MODE (continued)

**COLOR M.**

Return to the COLOR MANAGEMENT POINTER. (If you press the MENU button on the side control or the remote control, it returns to the COLOR MANAGEMENT POINTER and you will need to reselect and readjust the color.)

**MENU**

Return to the IMAGE ADJUST Menu. Any settings that have been changed will not be stored. To store the changed settings, be sure to select "LIST" and go to the COLOR MANAGEMENT LIST.

- 4 In the COLOR MANAGEMENT LIST, the adjusted color data are checkmarked. You can decide whether or not to apply the adjusted color data in the list to the projected image (see below).

LIST MODE



Clear the check mark if you do not want to apply the adjusted color data; select the check mark and then press the SELECT button. The check mark disappears.

**COLOR PALETTE**

Return to the COLOR SELECTION mode so that you can readjust the setting for the color in that line. (This option is not available if the check mark is cleared.)

**DEL**

Select the DEL box if you want to delete the adjusted data. Press the SELECT button and a confirmation box appears and then select [Yes]

**ALL DEL**

Delete all the data in the list. Press the SELECT button and a confirmation box appears and then select [Yes].

**MENU**

The same function as stated above.

**COLOR M.**

The same function as stated above.



**Auto picture control**

Use the Point ◀▶ buttons to select the desired Auto picture control position (Off, L1 or L2).

- Off . . . . Auto picture control OFF position.
- L1 . . . . Auto picture control LEVEL 1 position.
- L2 . . . . Auto picture control LEVEL 2 position.



**Color temp.**

Use the Point ◀▶ buttons to select the desired Color temp. level (High, Mid, Low, or XLow).

COLOR SELECTION MODE

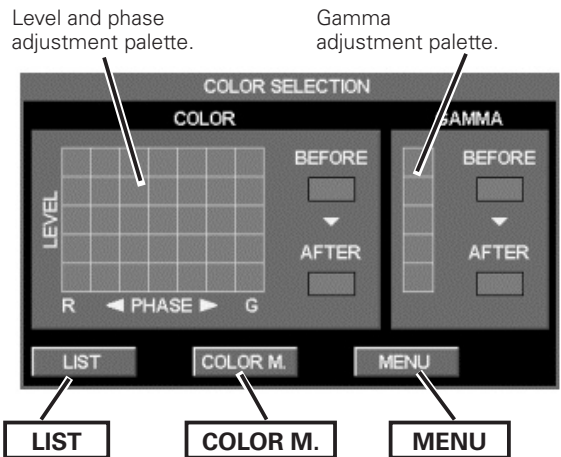

LIST MODE

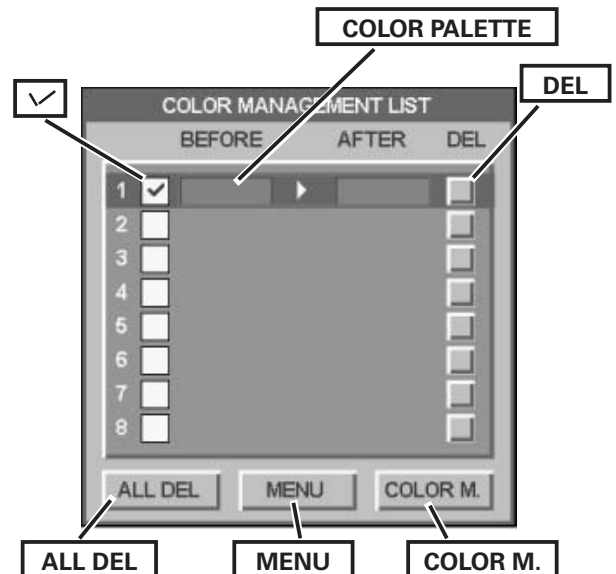

# Picture Image



## White balance (Red/Green/Blue)

Press the Point ◀ button to lighten red/green/blue tone; press the Point ▶ button to deepen red/green/blue tone (from 0 to 63).



## Offset (Red/Green/Blue)

Press the Point ◀ button to lighten red/green/blue tone of the black level of an image; press the Point ▶ button to deepen red/green/blue tone of the black level of an image (from 0 to 63).



## Sharpness

Press the Point ◀ button to decrease the sharpness of the image; press the Point ▶ button to increase the sharpness of the image (from 0 to 31).



## Gamma

Use the Point ◀▶ buttons to adjust the gamma value to obtain a better balance of contrast (from 0 to 15).



## Noise reduction \*

Noise interference on the screen can be reduced. Press the Point ◀▶ buttons to change the noise reduction mode.

- Off . . . . Noise reduction mode is "Off"
- On . . . . Noise reduction mode is "On"



## Progressive \*

An interlaced video signal can be displayed in progressive mode.

Press the Point ◀▶ buttons to change the progressive scan mode.

- Off . . . . Progressive scan mode is "Off."
- On . . . . Progressive scan mode is "On."

Film . . . . For watching a film. With this function, the projector reproduces pictures faithful to the original film quality.

### ✓ Note:

- Picture is distorted at the moment of On/Off /Film switching.



## Reset

To reset the adjusted data, select Reset and press the SELECT button. A confirmation box appears and then select [Yes]. All adjustments will return to their previous figures.



## Store

To store the adjusted data, move the red frame pointer to the Store icon and press the SELECT button. The Image Level Menu appears. Move the red arrow pointer to any of the Image 1 to 10 in which you want to set and press the SELECT button. A confirmation box appears and then select [Yes].



## Quit

Exit the Image Adjust Menu.

### ✓ Note:

- \* Displayed only in Video Input.
- When the White balance Red, Green, or Blue is adjusted, the Color temp. level will change to "Adj."
- The Film mode in the Progressive function cannot be selected when the video signal format is 1080i or 1035i.
- Progressive cannot be selected when "480p," "575p," or "720p" is selected (p.40).

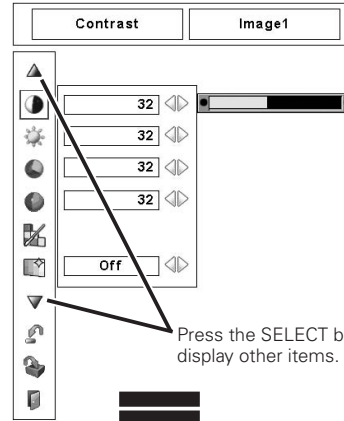

Press the SELECT button at this icon to display other items.

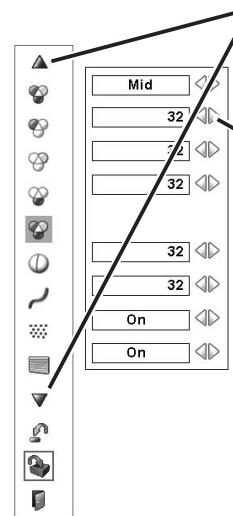

Press the SELECT button at this icon to display the previous items.

Press the Point ◀▶ buttons to adjust the setting value.

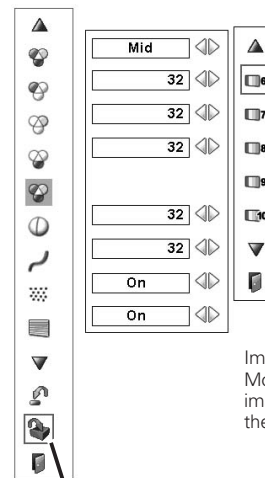

Image Level Menu  
Move the red frame pointer to an image item to be set and then press the SELECT button.

Store icon  
Press the SELECT button at this icon to store the adjustment.

# Setting

## Setting

This projector has a Setting menu that allows you to set up other various functions.

- 1 Press the MENU button to display the On-Screen Menu. Use the Point ◀▶ buttons to move the red frame pointer to the Setting Menu icon.
- 2 Use the Point ▲▼ buttons to move the red frame pointer to the desired item and then press the SELECT button. The Setting dialog box appears.

### Language

The language used in the On-Screen Menu is available in English, German, French, Italian, Spanish, Portuguese, Dutch, Swedish, Russian, Chinese, Korean, or Japanese.

### Menu

This function allows you to adjust the position of the On-Screen Display and the value adjustment bar in the Picture Image Adjustment Menu.

### Position

This function is used to adjust the On-Screen Menu display position. Press the SELECT button and the adjustment screen appears (arrows appear). Use the Point ▲▼◀▶ buttons to adjust the position. After making the adjustment, press the SELECT button to return to the Menu screen.

### Simple menu

When this function is set to "On," the value adjustment bar in the Picture Image Adjustment Menu appears on the screen.

### Display

This function decides whether to display On-Screen Displays.

- On . . . . . Shows all the On-Screen Displays. Use this function when you want to project images after the lamp becomes bright enough. The factory default setting is in this option.
- Countdown Off. . . Show the input image instead of the countdown when turning on the projector. Use this function when you want to project the image as early as possible even when the lamp is not bright enough.
- Off . . . . . Hide the On-Screen Displays except:
  - On-Screen Menu
  - "Power off?" (p.24)
  - Color management operation screen (pp.44-47)
  - "No signal" for Power management (p.51)
  - P-TIMER (p.29)
  - "Please wait...."
  - Arrows for the True function in the Screen Menu (p.38)

### Background

The selected background screen will be displayed when no input signal is detected.

- Blue . . . Blue colored background.
- User . . . The image you captured.
- Black . . . Black colored background.

### SETTING MENU (Language)

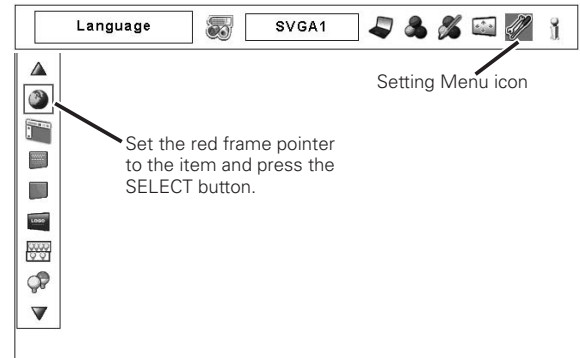

Press the SELECT button at Language, then the Language Menu appears.

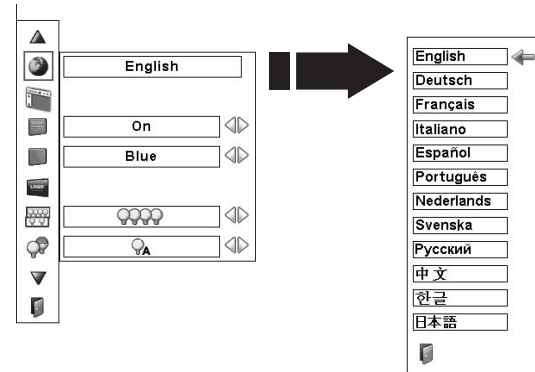

### Menu

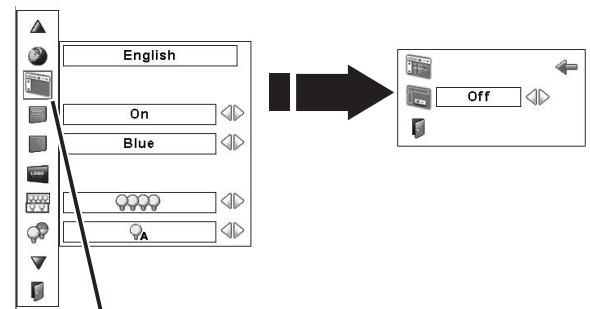

#### ✓ Note:

- User cannot be selected when the image is not captured.



## Logo

This function allows you to customize the screen logo with Logo select, Capture, and Logo PIN code lock functions.

### ✓ Note:

- When "On" is selected in the Logo PIN code lock function, Logo select and Capture functions cannot be selected.



## Logo select

This function decides on the starting-up display from among the following options.

- User . . . Show the image you captured.
- Default . Show the factory-set logo.
- Off . . . . Show the countdown display only.



## Capture

This function enables you to capture an image being projected to use it for a starting-up display or interval of presentations.

Select Capture and press the SELECT button.  
A confirmation box appears and select [Yes] to capture the projected image.

After capturing the projected image, go to the Logo select function and set it to "User". Then the captured image will be displayed the next time you turn on the projector.

To cancel the Capture function, select [No].

### ✓ Note:

- Before capturing an image, select "Standard" in the Image Select Menu to capture a proper image. (pp. 37, 41)
- A signal from a computer can be captured up to XGA (1024 X 768).
- Certain signals may not be captured properly.
- When capturing the image that has been adjusted by the Keystone function, the adjusted data is automatically reset and the projector captures an image without keystone correction.
- When starting to capture a new image, the previously stored image is cleared even if you cancel the capturing.
- Once you exit the Logo Menu after setting the Logo lock to "On," you are required to enter the PIN code every attempting to change the Logo setting.
- User cannot be selected when the image is not captured.

## Logo

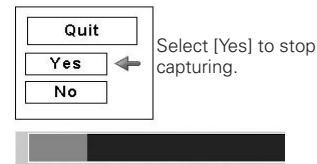
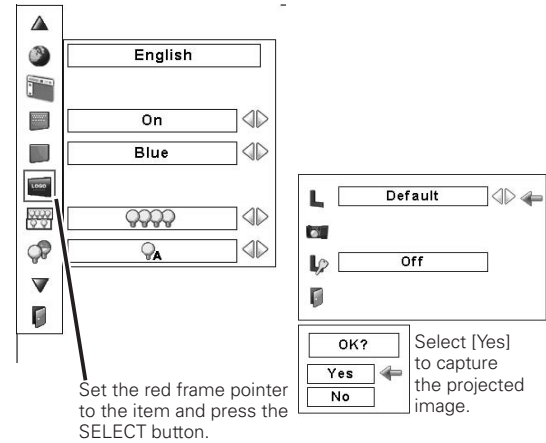

## Capture

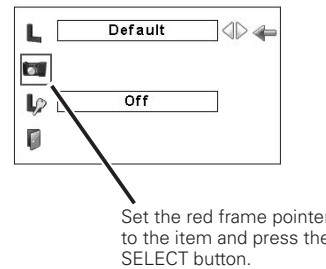

## **Logo PIN code lock**

This function prevents an unauthorized person from changing the screen logo.

- Off . . . . The screen logo can be changed freely from the Logo Menu.
- On . . . . The screen logo cannot be changed without a Logo PIN code.

If you want to change the Logo PIN code lock setting, press the SELECT button and the Logo PIN code dialog box appears. Enter a Logo PIN code by following the steps below. The initial Logo PIN code is set to "4321" at the factory.

### Enter a Logo PIN code

Use the Point ▲▼ buttons on the side control or on the remote control to enter a number. Press the Point ► button to fix the number and move the red frame pointer to the next box. The number changes to "\*" Repeat this step to complete entering a four-digit number. After entering the four-digit number, move the pointer to "Set." Press the SELECT button so that you can change the Logo PIN code lock setting.

If you fixed an incorrect number, use the Point ◀ button to move the pointer to the number you want to correct, and then enter the correct number.

If you entered an incorrect Logo PIN code, "Logo PIN code" and the number (\*\*\*\*) will turn red for a moment. Enter the correct PIN code all over again.

### Change the Logo PIN code lock setting

Use the Point ◀► buttons to switch On/Off, and then press the Point ▼ button to move the pointer to "Quit." Press the SELECT button to close the dialog box.

### Change the Logo PIN code

Logo PIN code can be changed to your desired four-digit number. Press the Point ▼ button to select "Logo PIN code change" and then press the SELECT button. The New Logo PIN code input dialog box appears. Set a new Logo PIN code.

Be sure to note the new Logo PIN code and keep it at hand. If you lost the number, you could no longer change the Logo PIN code setting. For details on PIN code setting, refer to "PIN code lock" on pages 52–53.

### Logo PIN Code Lock

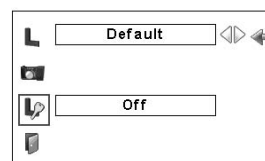

### Enter a Logo PIN code

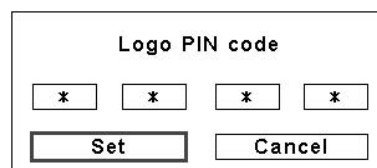

After a correct Logo PIN code is entered, the following dialog box appears.

### Change the Logo PIN code lock setting



Use the Point ◀► buttons to switch On/Off,

### Change the Logo PIN code

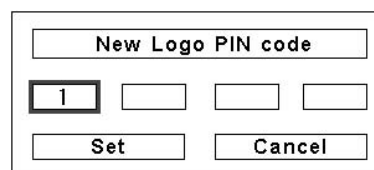

**CAUTION:**  
**WHEN YOU HAVE CHANGED THE LOGO PIN CODE, WRITE DOWN THE NEW PIN CODE IN COLUMN OF THE LOGO PIN CODE NO. MEMO ON PAGE 75, AND KEEP IT SECURELY. SHOULD THE LOGO PIN CODE BE LOST OR FORGOTTEN, THE LOGO PIN CODE SETTING CAN NO LONGER BE CHANGED.**



## Lamp mode

This Projector is equipped with 4 Projection Lamps and the number of using lamps can be switched to 4 lamps or 2 lamps. Using 2 lamps maintains the life of Projection Lamps. To change over Lamp Mode

Press the Point ▲▼ buttons to move the red frame pointer to "Lamp mode". Set "4 lamps mode" or "2 lamps mode" by pressing the Point ◀▶ buttons. When the Lamp Mode is switched from "4 lamps mode" to "2 lamps mode", the image becomes a little darker. When the Lamp Mode is switched from "2 lamps mode" to "4 lamps mode", the image becomes brighter gradually.



## Lamp control

This function allows you to change the brightness of the screen.

- Auto . . . . . Brightness according to the input signal.
- Normal . . . Normal brightness.
- Eco . . . . . Lower brightness. Lower brightness reduces the lamp power consumption and extends the lamp life.



## Fan control

Choose the running speed of cooling fans from the following options.

- Normal..... Normal speed.
- Max ..... Faster than the normal speed.



## Remote control

The eight different remote control codes (Code 1–Code 8) are assigned to the projector; the factory-set, initial code (Code 1) and the other seven codes (Code 2 to Code 8).

The same code should be set on both the projector and the remote control. For example, operating the projector in "Code 7", the remote control code also must be switched to "Code 7".

### **To change the code for the projector**

Select a remote control code in this Setting Menu.

### **To change the code for the remote control;**

Check the Reset Switch to "Use position" in the compartment lid on the back of the remote control.

And then during holding down the MENU button, press the IMAGE ADJ. button corresponding times to the number of the remote control code for the projector. (See page 16)

### **To reset the code for the remote control:**

Slide the Reset Switch to "Reset position" in the compartment lid on back of the remote control.

### ✓Note:

- After changing the Lamp Mode, it cannot be switched again for 90 seconds.

### Remote control

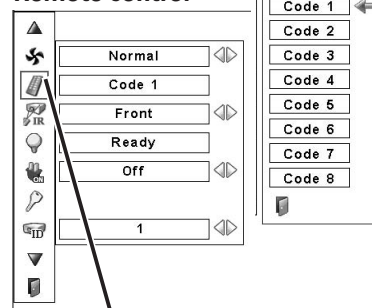

When pressing the SELECT button at Remote control, the Remote control code menu appears.

## RC sensor

Select a location of the infrared remote receiver of the remote control. See “Remote Control Receivers and Operating Range” on page 15 for details.

- Both..... Activate both the front and back receiver.
- Front..... Activate only the front receiver.
- Back..... Activate only the back receiver.

## Power management

For reducing power consumption as well as maintaining the lamp life, the Power management function turns off the projection lamp when the projector is not used for a certain period.

If the input signal is interrupted and no button is pressed for more than 30 seconds, the timer display with “No signal” appears. It starts the countdown until the lamp is turned off. The countdown time can be set between 1 and 30 minutes. Use the Point ◀▶ buttons to set the countdown timer.

Select one of the following options:

- Ready . . . . . When the lamp has been fully cooled down, the READY indicator starts blinking. In this condition, the projection lamp is turned on if the input signal is reconnected or any button on the side control or remote control is pressed .
- Shutdown . . . . . When the lamp has been fully cooled down, the power is turned off.
- Off . . . . . Power Management function is off.

### ✓ Note:

- Factory default is “Ready: 5 min.”

## On start

When this function is set to “On,” the projector will be automatically turned on just by connecting the AC power cord to the wall outlet.

### ✓ Note:

- Make sure that the main switch is ON, otherwise the On start function does not work.
- Be sure to turn off the projector properly (see “Turning Off the Projector” on page 24). If the projector is turned off in the incorrect sequence, the On start function does not work properly.

## Power management



Time left before the lamp is off

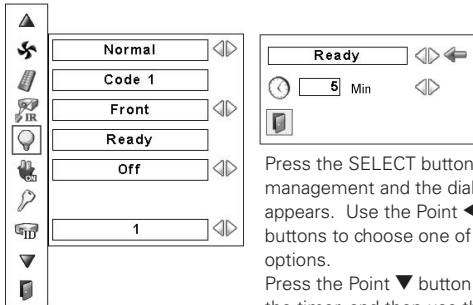

Press the SELECT button at Power management and the dialog box appears. Use the Point ◀▶ buttons to choose one of the three options. Press the Point ▼ button to select the timer, and then use the Point ◀▶ buttons to set the timer





## Security

### Key lock

This function locks the side control and remote control buttons to prevent operation by unauthorized persons.

 . . . . . Unlocked.

 . . . . . Lock the side control buttons.  
To unlock, use the remote control.

 . . . . . Lock the remote control buttons.  
To unlock, use the side control.

If the side control accidentally becomes locked and you do not have the remote control nearby and unable to operate the projector, contact the service station.

### PIN code lock

This function prevents the projector from being operated by unauthorized persons and provides the following setting options for security.

Off . . . . . Unlocked.

On1 . . . . . Enter the PIN code every time turning on the projector.

On2 . . . . . Enter the PIN code to operate the projector once the power cord is disconnected; as long as the AC power cord is connected, the projector can be operated without a PIN code.

Whenever you change the PIN code lock setting or the PIN code (the four-digit number), you are required to enter the PIN code. "1234" is set as the initial PIN code at the factory.

If you want to change the PIN code lock setting, press the SELECT button and the PIN code dialog box appears. Enter a PIN code by following the steps on the next page.

## Security

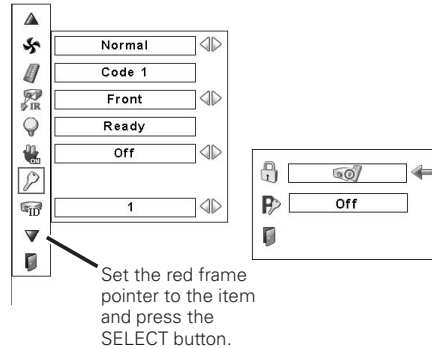

## Key lock

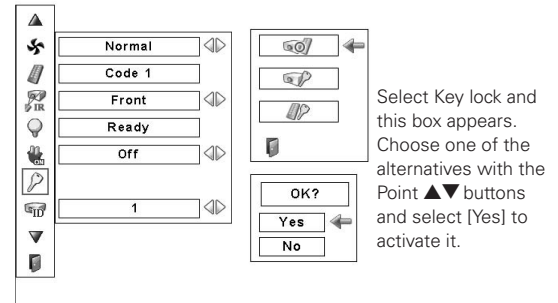

## PIN code lock

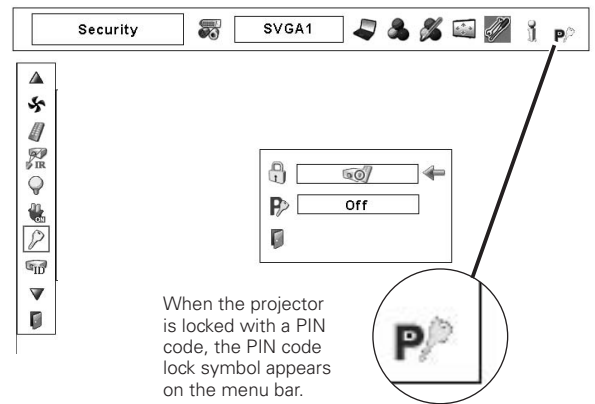



**Enter a PIN code**

Use the Point ▲▼ buttons on the side control or on the remote control to enter a number. Press the Point ► button to fix the number and move the red frame pointer to the next box. The number changes to “\*.” Repeat this step to complete entering a four-digit number. After entering the four-digit number, move the pointer to “Set.” Press the SELECT button so that you can change the PIN code lock setting .

If you fixed an incorrect number, use the Point ◀ button to move the pointer to the number you want to correct, and then enter the correct number.

If you entered an incorrect PIN code, “PIN code” and the number (\*\*\*\*) will turn red for a moment. Enter the correct PIN code all over again.

**Change the PIN Code Lock setting**

Use the Point ◀► button to select Off, On1, or On2 and then move the pointer to “Quit” with the Point ▼ button. Press the SELECT button to close the dialog box.

**Change the PIN Code**

The PIN code can be changed to your desired four-digit number. Press the Point ▼ buttons to select “PIN code change” and press the SELECT button. The New PIN code input dialog box appears. Set a new PIN code.

**CAUTION:**  
**WHEN YOU HAVE CHANGED THE PIN CODE, WRITE DOWN A NEW PIN CODE IN COLUMN OF THE PIN CODE NO. MEMO ON PAGE 75, AND KEEP IT SECURELY. IF YOU FORGET YOUR PIN CODE, THE PROJECTOR CAN NO LONGER BE STARTED.**

**Enter a PIN code**

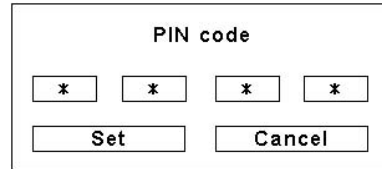

After a correct Logo PIN code is entered, the following dialog box appears.

**Change the PIN code lock setting**



Use the Point ◀► buttons to switch between the options.

**Change the PIN code**

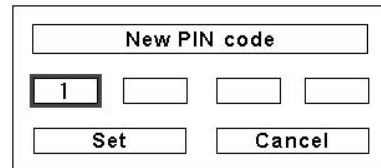

 **Projector ID**

This feature allows users to set serial communication configuration (Projector ID) when several projectors are connected via the RS-232C terminal (serial port) of the projector.

Use the Point ◀► buttons to adjust the Projector ID.

- Projector ID ... 1 - 999. (Factory default setting : Projector ID 1)



## Lamp counter

This function is used to reset the lamp counter.

When the lamp life reaches a recommended lamp replacement time, the time shown in the dialog box turns red and the Lamp replacement icon appears on the screen, indicating that the end of lamp life is approaching.

When replacing the projection lamp, reset the lamp counter. See "Resetting the Lamp Counter" on page 58.

### ✓ Note:

- The Lamp replacement icon will not appear when the Display function is set to "Off" (p.47), during "Freeze" (p.28), or "No show" (p.29).



## Filter counter

This function is used to set a frequency for the filter cleaning.

When the projector reached a specified time between cleanings, a Filter warning icon appears on the screen, notifying the cleaning is necessary. After cleaning the filter, be sure to select RESET and set the timer. The Filter warning icon will not turn off until the filter counter is reset.

For details about resetting the timer, refer to "Resetting the Filter Counter" on page 55.



## Test pattern

Various test pattern are available for use when setting up the projector.



## Factory default

This function returns all setting values except for the user logo, PIN code lock, Logo PIN code lock, lamp counter, filter counter and filter timer to the factory default settings.



## Quit

Exit the Setting Menu.



This icon appears on the screen when the end of lamp life is approaching.

### ✓ Note:

- This icon also appears at turning on and selecting input source.

## Filter counter



Set the red frame pointer to the item and press the SELECT button.

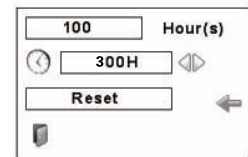

Use the Point ◀▶ buttons to set the timer. Select from (Off/ 100H/300H/500H) depending on the use environment



**Fig.1** Filter warning icon

Filter warning icon appears on the screen at a set time.

### ✓ Note:

- Fig.1 appear at turning on and selecting input source.
- Fig.1 will not appear when the Display function is set to "Off" (p.47), during "Freeze" (p.28), or "No show" (p.29).

## Factory default

Set the red frame pointer to the item and press the SELECT button.



Select Factory default and this box appears. Select [Yes], and the next box appears.

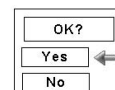
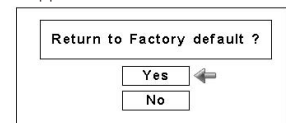

Select [Yes] to activate it.

# Maintenance and Care

## Air Filter Care and Cleaning

Filter prevents dust from accumulating on the optical elements inside the projector. Should the filter become clogged with dust particles, it will reduce cooling fans' effectiveness and may result in internal heat buildup and adversely affect the life of the projector. If a "Filter warning" icon appears on the screen, clean the filter immediately. Clean the filter by following the steps below.

- 1 Turn off the projector, and unplug the AC power cord from the AC outlet.
- 2 Pull out the air filter from the projector.
- 3 Clean the filter with brush out dust and particles.
- 4 Replace the air filter in a projector.

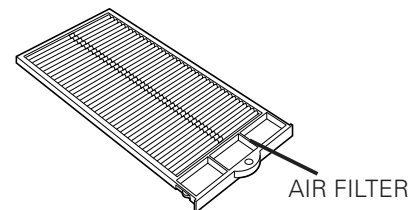
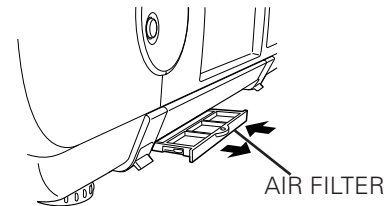

### CAUTION

Do not operate the projector with the Air Filter(s) removed. Dust may accumulate on the LCD Panels and Projection Mirrors degrading the picture quality. Do not put anything into the air intake vents. Doing so may result in a malfunction of the projector. Failure to properly clean the projector's air filters (in accordance with the instructions in your Projector's Operating Manual, or more frequently in any environment which is somewhat dusty or smoky) could result in overheating and will void the warranty on the projector.

### ✓Note:

- If the filter is heavily clogged and unable to clean, replace it with new ones. Please consult your dealer for details.
- Do not wash the filter with water or any other liquid matter.

Air Filter Parts No. 610 334 1057

## Resetting the Filter Counter

Be sure to reset the Filter counter after cleaning or replacing the filter.

- 1 Press the MENU button to display the On-Screen Menu. Use the Point ◀▶ buttons to move the red frame pointer to the Setting Menu icon.
- 2 Use the Point ▲▼ buttons to move the red frame pointer to Filter counter and then press the SELECT button. A dialog box appears showing the Used time option and the Scrolls remaining option. Use the Point ▲▼ buttons to select Used time.
- 3 Used time shows the total accumulated time of the filter use, a timer setting option, and the Reset option. Select Reset and the "Filter counter Reset?" appears. Select [Yes] to continue.
- 4 Another confirmation dialog box appears, select [Yes] to reset the Filter counter.

### Filter counter

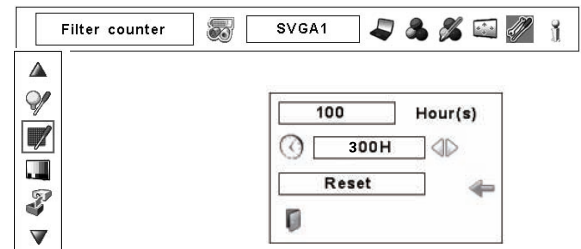

Select Reset and the "Filter counter Reset?" appears.

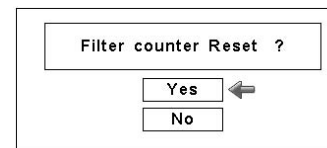

Select [Yes], then another confirmation box appears.

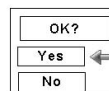

Select [Yes] again to reset the Filter counter.

## Lamp Management

This Projector is equipped with 4 Projection Lamps to ensure brighter image and those lamps are controlled by the Lamp Management Function. The Lamp Management Function detects the status of all lamps and shows the status on screen or on the LAMP REPLACE indicator. This function also automatically controls the Lamp Mode when any of lamps is out for the end of life or malfunctions.

LAMP REPLACE INDICATOR

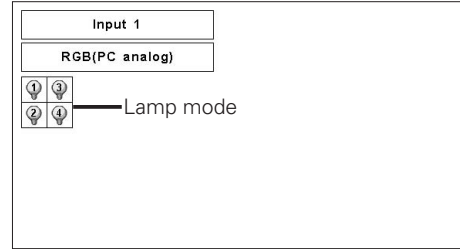
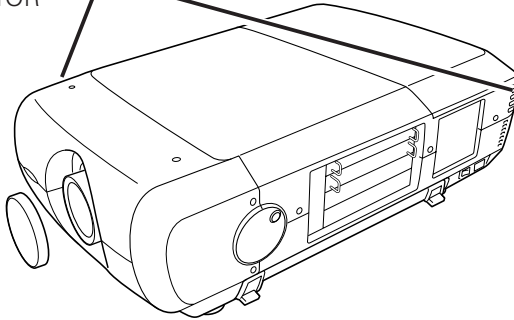

### Lamp Replace Indicator

This LAMP REPLACE indicator lights orange when any of Projection Lamps is nearing its end, and flashes when any of them becomes out. Check the number of lamp on the Lamp Status Display and the replace lamp.

### Lamp Status Display

Lamp Status Display appears on screen when the power switch is on or changed input position (input 1, input 2, Input 3 or input 4). This shows the status of each lamp as; ON, OFF, NEAR END, or OUT. Refer to the following for each status.

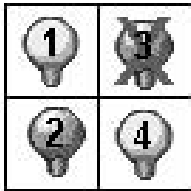

LAMP STATUS DISPLAY

**Yellow Lamp** ----- Projection Lamp lights normally.

**Dim Lamp** ----- Projection Lamp is turned off.

**Red Lamp** ----- Projection Lamp is nearing its end. When the image becomes darker or the color becomes unnatural, replace lamp. (LAMP REPLACE indicator lights orange.)

**X Mark on Lamp** ----- (LAMP REPLACE indicator flashes orange.) Projection lamp is defective or fails to be turned on. Restart a projector on, and make sure lamp is on. If this mark still appears, replace lamp corresponding with number marked X.

### Lamp Mode Changeover

The Lamp Management Function automatically changes the combination of lighting lamp (Lamp Mode) by detecting the status of lamp. When any of 4 lamps becomes out, the Lamp Mode is changed over from 4 lamps to 2 lamps. And when any of 2 lamps are out, the projector operates with 1 lamp. The Lamp Mode can be switched to 4 lamps or 2 lamps manually. Refer to the SETTING section on page 50.



4 LAMP MODE

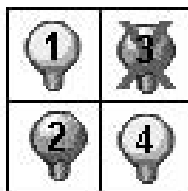

2 LAMP MODE  
(Example)



1 LAMP MODE  
(Example)

## Lamp Replacement

When the projection lamp of the projector reaches its end of life, the Lamp replacement icon appears on the screen and LAMP REPLACE indicator lights orange. Replace the lamp with a new one promptly. The timing when the LAMP REPLACE indicator should light is depending on the lamp mode.

### Indicators

LAMP 

READY 

WARNING TEMP. 

LAMP REPLACE 

### LAMP REPLACE indicator



Lamp replacement icon



### WARNING:

TURN OFF THE UV LAMP BEFORE OPENING THE LAMP COVER.



Allow a projector to cool, for at least 45 minutes before you open Lamp Cover. The inside of a projector can become very hot.



### CAUTION

For continued safety, replace with a lamp assembly of the same type.

Do not drop the lamp assembly or touch a glass bulb! The glass can shatter and may cause injury.

### ✓ Note:

- The Lamp replacement icon will not appear when the Display function is set to "Off" (p.47), during "Freeze" (p.28), or "No show" (p.29).

Follow these steps to replace the lamp.

- 1 Check the number of lamp to be replaced on the Lamp Status Display.
- 2 Turn off the projector and unplug the AC Power Cord. Let the projector cool for at least 45 minutes.
- 3 Remove the two screws on the Lamp Cover and press the button to open the Lamp Cover. (See the right figure.)
- 4 Loosen two screws and pull out the Lamp to be replaced by grasping handle.
- 5 Replace the Lamp with a new one and tighten two screws. Make sure the Lamp is set properly.
- 6 Put the Lamp Cover back and tighten two screws.
- 7 Connect the AC Power Cord to the projector and turn on the projector.
- 8 Reset the Lamp Replacement Counter. (Refer to section "Resetting the Lamp Counter" on page 58.)

NOTE : Do not reset LAMP REPLACEMENT COUNTER when lamp is not replaced.

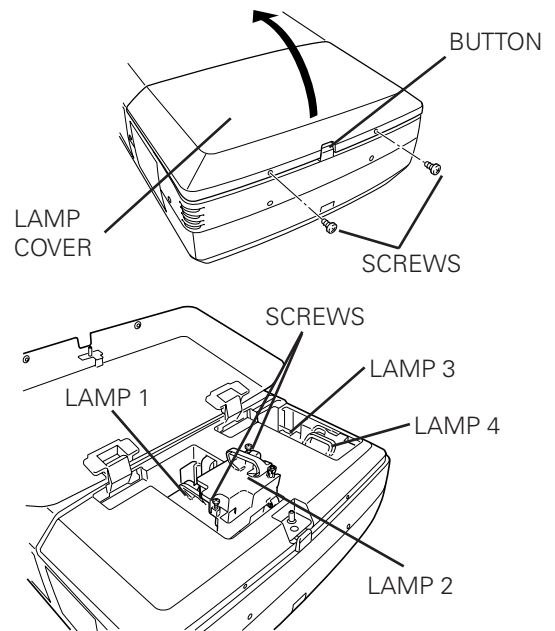

Make sure which number of lamp needs to be replaced on Lamp Status Display. Figure shows case of replacing LAMP 2.

**CAUTION : DO NOT OPERATE A PROJECTOR WHILE ANY OF LAMPS IS REMOVED. IT MAY RESULT IN MALFUNCTIONS, FIRE HAZARD, OR OTHER ACCIDENTS.**

### NOTES ON LAMP REPLACEMENT

To maintain quality of picture (better balance of color and brightness in entire screen), we recommend replacing all 4 lamps at a time.

## Resetting the Lamp Counter

Be sure to reset the Lamp counter after the lamp is replaced. When the Lamp counter is reset, the LAMP REPLACE indicator stops lighting and the Lamp replacement icon disappears.

- 1** Press the MENU button to display the On-Screen Menu. Use the Point ◀▶ buttons to move the red frame pointer to the Setting Menu icon
- 2** Use the Point ▲▼ buttons to move the red frame pointer to Lamp counter and then press the SELECT button. A dialog box appears. Select a lamp and the "Lamp replacement counter Reset?" appears. Select [Yes] to continue.
- 3** Another confirmation dialog box appears and select [Yes] to reset the Lamp counter.

✓ **Note:**

- Do not reset the Lamp counter without replacing the lamp. Be sure to reset the Lamp counter only after replacing the lamp.

### Lamp counter

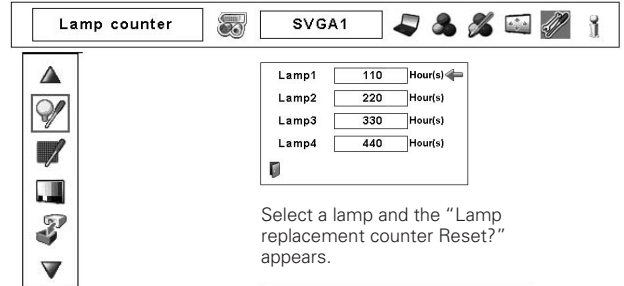

Select a lamp and the "Lamp replacement counter Reset?" appears.

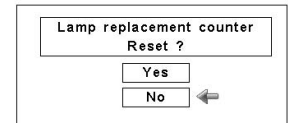

Select [Yes], then another confirmation box appears.

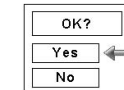

Select [Yes] again to reset the lamp counter.

### ORDER REPLACEMENT LAMP

Replacement Lamp can be ordered through your dealer. When ordering a Projection Lamp, give the following information to the dealer.

- **Model No. of your projector** : **PLC-XF47/PLC-XF47K**
- **Replacement Lamp Type No.** : **POA-LMP109**

(Service Parts No. 610 334 6267)



## LAMP HANDLING PRECAUTIONS

This projector uses a high-pressure lamp which must be handled carefully and properly. Improper handling may result in accidents, injury, or create a fire hazard.

- Lamp lifetime may differ from lamp to lamp and according to the environment of use. There is no guarantee of the same lifetime for each lamp. Some lamps may fail or terminate their lifetime in a shorter period of time than other similar lamps.
- If the projector indicates that the lamp should be replaced, i.e., if the LAMP REPLACE indicator lights up, replace the lamp with a new one IMMEDIATELY after the projector has cooled down. (Follow carefully the instructions in the Lamp Replacement section of this manual.) Continuous use of the lamp with the LAMP REPLACE indicator lighted may increase the risk of lamp explosion.
- Lamp may explode as a result of vibration, shock or degradation as a result of hours of use as its lifetime draws to an end. Risk of explosion may differ according to the environment or conditions in which the projector and lamp are being used.

### **IF A LAMP EXPLODES, THE FOLLOWING SAFETY PRECAUTIONS SHOULD BE TAKEN.**

If a lamp explodes, disconnect the projector's AC plug from the AC outlet immediately. Contact an authorized service station for a checkup of the unit and replacement of the lamp. Additionally, check carefully to ensure that there are no broken shards or pieces of glass around the projector or coming out from the cooling air circulation holes. Any broken shards found should be cleaned up carefully. No one should check the inside of the projector except those who are authorized trained technicians and who are familiar with projector service. Inappropriate attempts to service the unit by anyone, especially those who are not appropriately trained to do so, may result in an accident or injury caused by pieces of broken glass.

### ***Cleaning the Projection Lens***

Unplug the AC power cord before cleaning.

Gently wipe the projection lens with a cleaning cloth that contains a small amount of non-abrasive camera lens cleaner, or use a lens cleaning paper or commercially available air blower to clean the lens.

Avoid using an excessive amount of cleaner. Abrasive cleaners, solvents, or other harsh chemicals might scratch the surface of the lens.

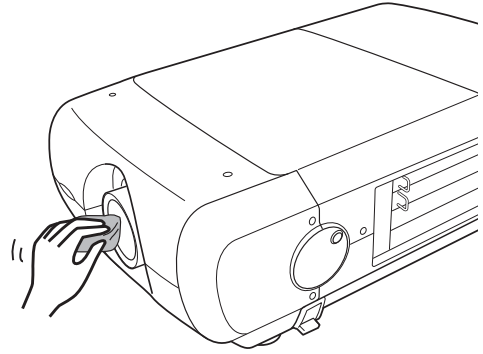

### ***Cleaning the Projector Cabinet***

Unplug the AC power cord before cleaning.

Gently wipe the projector body with a soft dry cleaning cloth. When the cabinet is heavily soiled, use a small amount of mild detergent and finish with a soft dry cleaning cloth. Avoid using an excessive amount of cleaner. Abrasive cleaners, solvents, or other harsh chemicals might scratch the surface of the cabinet.

When the projector is not in use, put the projector in an appropriate carrying case to protect it from dust and scratches.

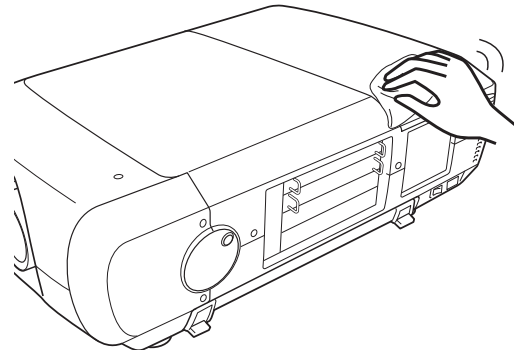



## Warning Indicators

The WARNING indicators show the state of the function which protects the projector. Check the state of the WARNING indicators and the READY indicator to take proper maintenance.

### **The projector is shut down and the WARNING TEMP. indicator is blinking red.**

When the temperature inside the projector reaches a certain level, the projector will be automatically shut down to protect the inside of the projector. The LAMP indicator turns red and the WARNING TEMP. indicator blinks while the projector is being cooled down. When the projector has cooled down enough (to its normal operating temperature), it can be turned on again by pressing the ON/STAND-BY button.

**✓ Note:**

- The WARNING TEMP. indicator continues to blink even after the temperature inside the projector returns to normal. When the projector is turned on again, the WARNING TEMP. indicator stops blinking.

**Then check the matters below:**

- Did you provide appropriate space for the projector to be ventilated? Check the installing condition to see if the air vents of the projector are not blocked.
- Has the projector been installed near an Air-Conditioning/ Heating Duct or Vent? Move the installation of the projector away from the duct or vent.
- Is the filter clean? Clean the filter.

### **The projector is shut down; and the LAMP indicator is lighting and other indicators are blinking.**

When the projector detects an abnormal condition, it will be automatically shut down to protect the inside of the projector and the LAMP indicator lights on and other indicators blink. In this case, unplug the AC power cord and plug it, and then turn on the projector once again to verify operation. If the projector cannot be turned on and these indicators are still lighting and blinking, unplug the AC power cord and contact the service station.



**CAUTION**

DO NOT LEAVE THE PROJECTOR WITH THE AC POWER CORD CONNECTED UNDER AN ABNORMAL CONDITION. IT MAY RESULT IN FIRE OR ELECTRIC SHOCK.

### Indicators

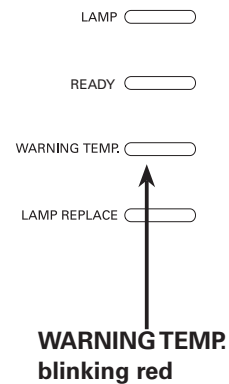

### Indicators

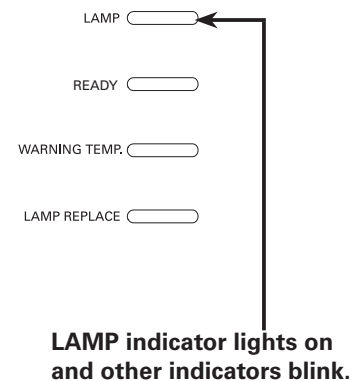



# Appendix

## Troubleshooting

Before calling your dealer or service center for assistance, check the items below once again.

1. Make sure you have properly connected the projector to peripheral equipment as described on pages 20–21.
2. Check the cable connection. Make sure that all computers, video equipment, and power cords are properly connected.
3. Make sure that all power is switched on.
4. If the projector still does not produce an image, restart your computer.
5. If an image still does not appear, disconnect the projector from your computer and check your computer monitor's display. A problem may be noticed with your graphics controller rather than with the projector. (When you reconnect the projector, be sure to turn the computer and monitor off before you turn on the projector. Turn on equipment in the order of the projector and computer.)
6. If a problem still persists, check the following solutions.

Problem:	Solutions
<b>No power.</b>	<ul style="list-style-type: none"> <li>– Plug the power cord of the projector into the AC outlet.</li> <li>– Turn the MAIN ON/OFF switch to ON.</li> <li>– Press the ON/STAND-BY Button to ON.</li> <li>– Make sure the READY Indicator lights.</li> <li>– Check the WARNING TEMP. and the READY indicator. If both the WARNING TEMP. and the READY indicator flashes, a projector cannot be turned on. (See "TURNING ON/OFF THE PROJECTOR" section on pages 23-24.)</li> <li>– Check the projection lamp. (Refer to page 57.)</li> </ul>
<b>Image is out of focus.</b>	<ul style="list-style-type: none"> <li>– Adjust focus of the projector.</li> <li>– Check Projection Lens to see if it needs cleaning.</li> <li>✓<b>Note:</b> Moving a projector from a cool temperature location to a warm temperature location may result in moisture condensation on Projection Lens. In such cases, leave the projector OFF and wait until condensation evaporates.</li> </ul>
<b>Picture is Left/Right reversed.</b>	<ul style="list-style-type: none"> <li>– Check the Ceiling / Rear function. (See page 43.)</li> </ul>
<b>Picture is Top/Bottom reversed.</b>	<ul style="list-style-type: none"> <li>– Check the Ceiling function. (See page 43)</li> </ul>
<b>Some displays are not seen during Operation.</b>	<ul style="list-style-type: none"> <li>– Check the Display function. (See "SETTING" section on page 47.)</li> </ul>
<b>No image.</b>	<ul style="list-style-type: none"> <li>– Check the connection between your computer or video equipment and a projector.</li> <li>– It takes about 20 seconds to display an image after turning on the projector.</li> <li>– See if the selected system is corresponding with your computer or video equipment.</li> <li>– Make sure the temperature is not out of Operating Temperature (41°F–95°F [5°C–35°C]).</li> </ul>
<b>The initial display is not shown.</b>	<ul style="list-style-type: none"> <li>– Make sure "Off " or "Countdown Off" are not chosen at Display function. (See "SETTING" section on page 47)</li> </ul>
<b>The initial display is not same with the default one.</b>	<ul style="list-style-type: none"> <li>– Make sure "User" or "Off" are not chosen at Logo select function. (See "SETTING" section on page 48)</li> </ul>
 <p><b>appears on the screen</b></p>	<ul style="list-style-type: none"> <li>– The end of lamp life is approaching. Replace the lamp with a new one promptly. (See page 57)</li> </ul>

<p><b>Picture is not bright enough.</b></p>	<ul style="list-style-type: none"> <li>-Check if "Contrast" or "Brightness" are adjusted properly. (See page 44)</li> <li>-Check if "Image level" is selected properly. (See pages 37, 41)</li> <li>-Check the Lamp control function. ( See "SETTING" section on page 50)</li> <li>- Check the Lamp replace indicator. If it lights, the end of lamp life is approaching. Replace the lamp with a new one promptly. (See page 57)</li> <li>-The image is darker when 2 lamp mode is selected, compared with 4 lamp mode. Check the lamp mode at SETTING section on page 50.</li> </ul>
<p><b>The color is strange.</b></p>	<ul style="list-style-type: none"> <li>-Check the Input signal, color system, video system, or computer system mode.</li> </ul>
<p><b>The image is distorted or runs off.</b></p>	<ul style="list-style-type: none"> <li>-Check "PC Adjust" menu or " Screen" menu and adjust them.</li> </ul>
<p><b>Auto PC adjustment function does not work.</b></p>	<ul style="list-style-type: none"> <li>-Check the Input signal. Auto PC Adjustment function can not work when 480p, 575p, 720p, 480i, 575i, 1035i, or 1080i is selected or when the digital signal is input into DVI terminal. (See page 34)</li> </ul>
<p><b>The setting does not remain after turning off power.</b></p>	<ul style="list-style-type: none"> <li>-Make sure you selected "Store" after adjusting settings. Some settings can not be stored if not registered with "Store".</li> </ul>
<p><b>Power management function does not work.</b></p>	<ul style="list-style-type: none"> <li>-Power management function can not work while "Freeze" or "No Show" function is running.</li> </ul>
<p><b>Capture function does not work.</b></p>	<ul style="list-style-type: none"> <li>-Check the connection to see if there is signal.</li> </ul>
<p><b>Some menus can not be selected.</b></p>	<ul style="list-style-type: none"> <li>-Each of the Video Input and Computer Input has a limit on selectable menus.</li> </ul>
<p><b>The power is turned off automatically.</b></p>	<ul style="list-style-type: none"> <li>-Power management function runs by initial setting. Check "SETTING" section on page 51.</li> </ul>
<p><b>You can not operate with the side control.</b></p>	<ul style="list-style-type: none"> <li>-The side control is not available If the side control is locked at "Key lock" under "Security" of SETTING section. Please check "SETTING" section on page 52.</li> </ul>
<p><b>Indicators blinks or lights.</b></p>	<ul style="list-style-type: none"> <li>-Check the status of the projector with referring to " INDICATORS AND PROJECTOR CONDITION" on pages 68-69.</li> </ul>
<p><b>The Remote Control does not work.</b></p>	<ul style="list-style-type: none"> <li>-Check the batteries.</li> <li>-Check if the RC sensor is set properly.(See page 51)</li> <li>-Make sure no obstruction is between the projector and remote control.</li> <li>-Make sure you are not too far from a projector when using the remote control. Maximum operating range is 16.4' (5m).</li> <li>-Make sure that the remote control code conforms to the projector's code. (See "SETTING" section on page 50.)</li> <li>-Make sure the reset switch in the compartment lid on back of the remote control is set to use position.</li> <li>-Unlock the Key lock function for the remote control. (See page 52)</li> <li>-Wireless remote control does not work when the remote control cable is connected to the projector. (See page 15)</li> </ul>
<p><b>Unable to unlock the Logo PIN code lock, Security key lock or Security PIN code lock.</b></p>	<ul style="list-style-type: none"> <li>-Contact the dealer where you purchased the projector or the service center.</li> </ul>
<p><b>Forget the Logo PIN code or Security PIN code.</b></p>	<ul style="list-style-type: none"> <li>-Contact the dealer where you purchased the projector or the service center.</li> </ul>
<p> <b>appears on the screen</b></p>	<ul style="list-style-type: none"> <li>-Your operation is invalid. Operate correctly.</li> </ul>

**WARNING:**

**High voltages are used to operate this projector. Do not attempt to open the cabinet.**

If problems still persist after following all operating instructions, contact the dealer where you purchased the projector or the service center. Specify the model number and explain about the problem. We will advise you how to obtain service.



This symbol on the nameplate means the product is Listed by Underwriters Laboratories Inc. It is designed and manufactured to meet rigid U.L. safety standards against risk of fire, casualty, and electrical hazards.



The CE Mark is a Directive conformity mark of the European Community (EC).



Pixelworks ICs used.

## Menu Tree

### Computer Input/Video Input

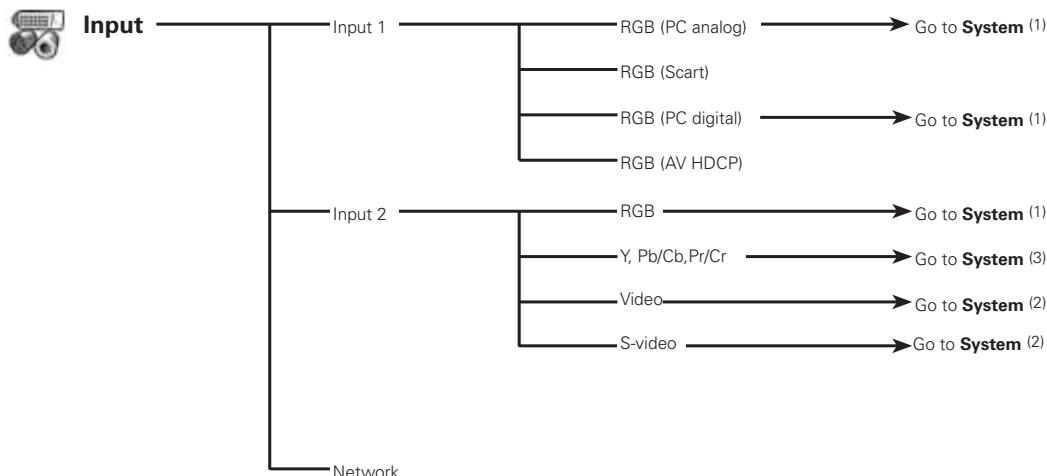

### Information

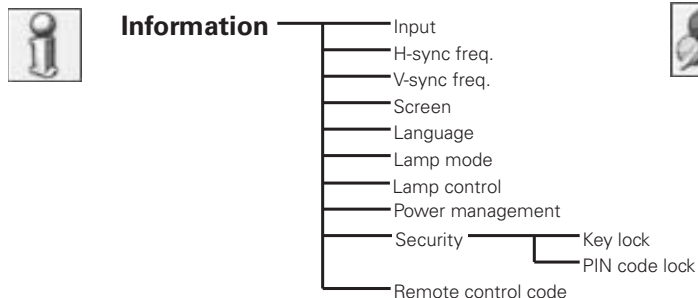

### Image Adjust

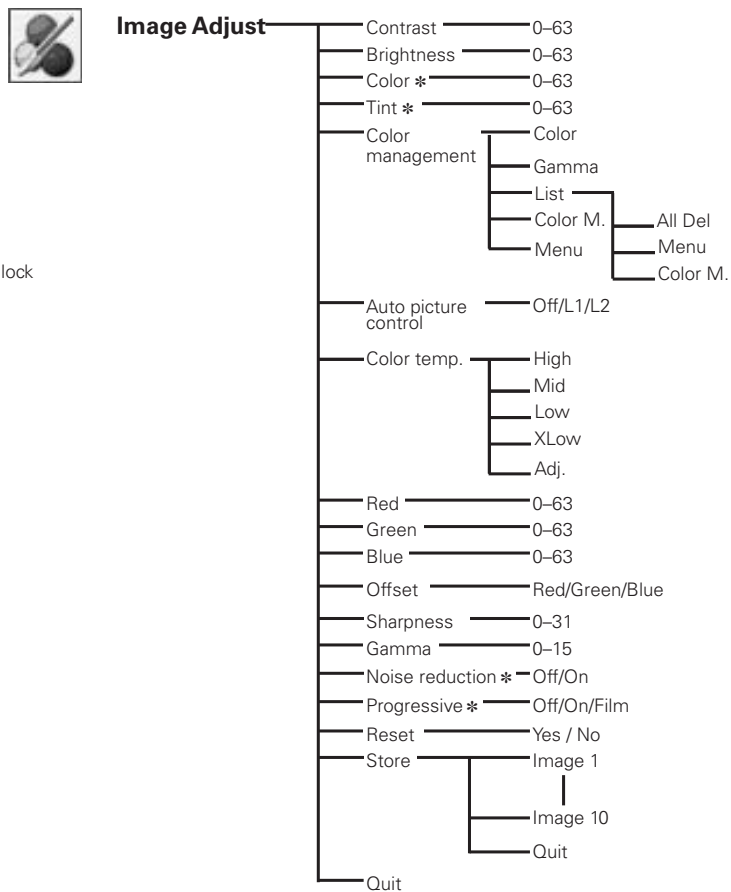

\* Displayed only in Video Input

✓ **Note:**

- The Menu display varies depending on the input signal.

## Computer Input

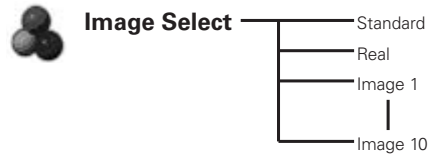
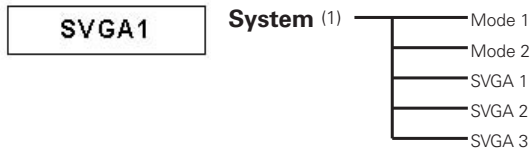

\* System displayed in the System Menu varies depending on the input signal.

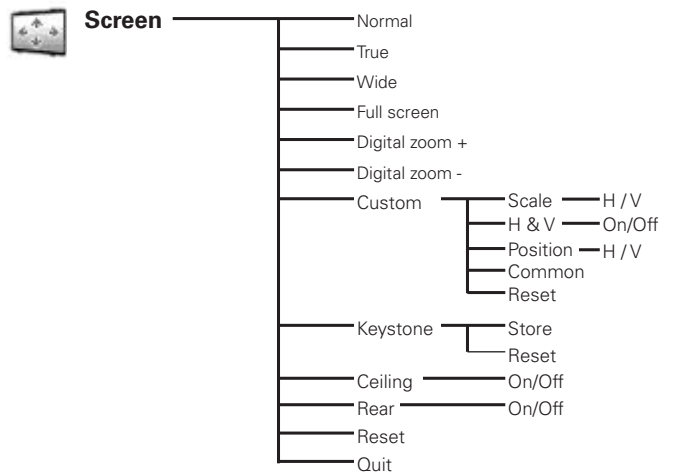
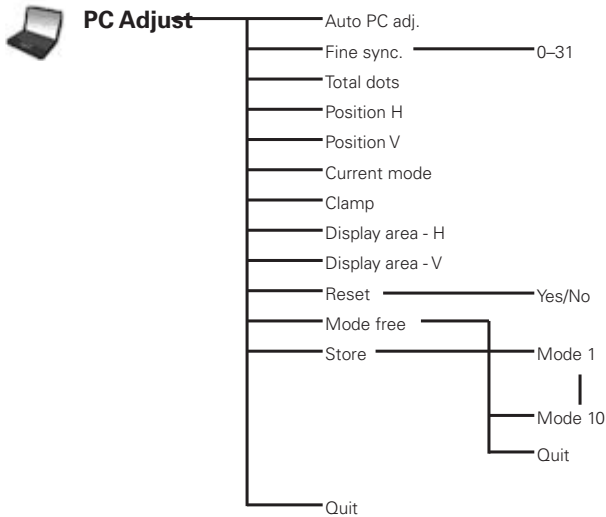

## Video Input

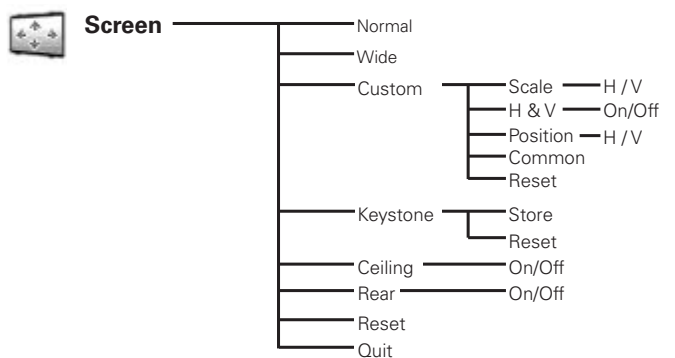
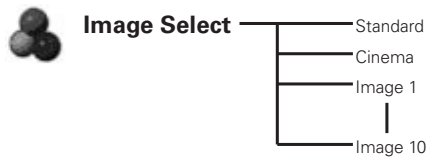
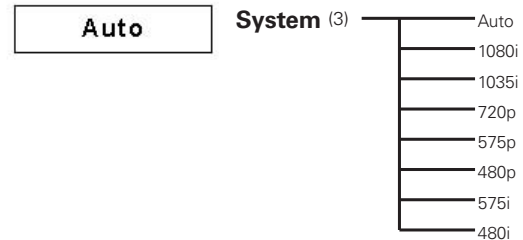
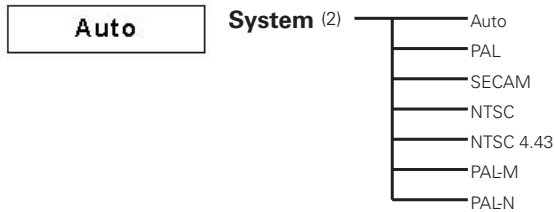

✓ **Note:**

• The Menu display varies depending on the input signal.

## Computer Input/Video Input



### Setting

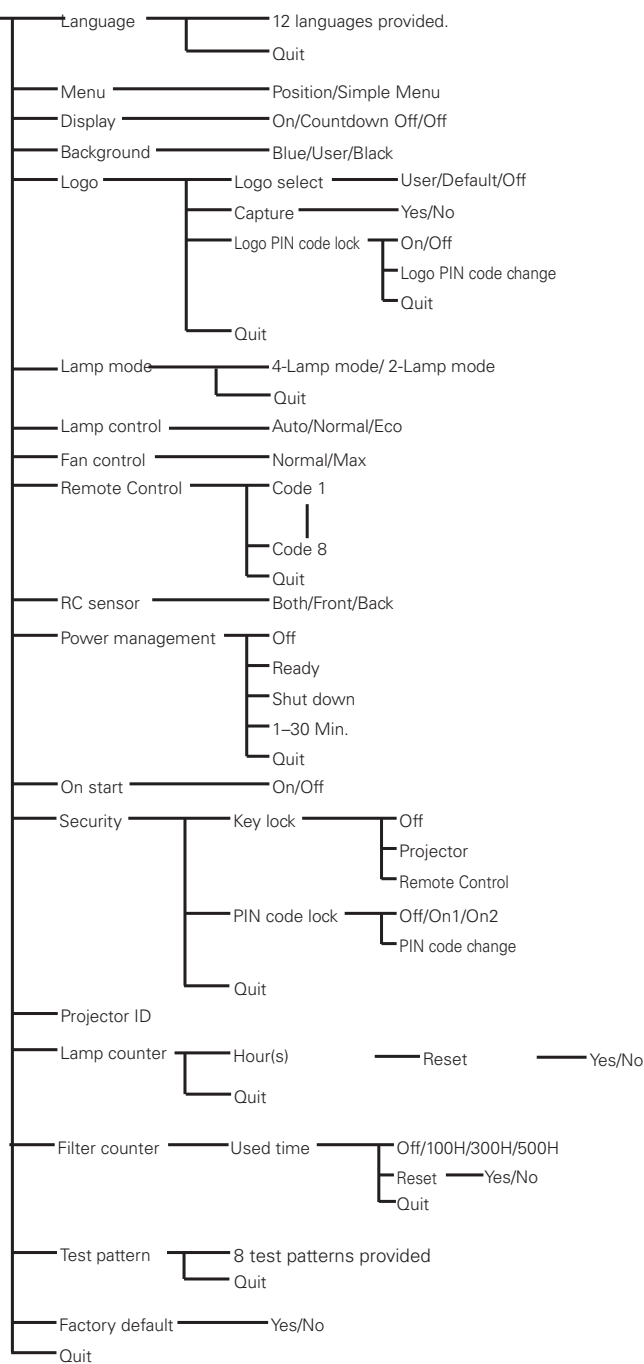

## Indicators and Projector Condition

Check the indicators for the projector condition.

### The projector is operating normally.

Indicators				Projector Condition
LAMP red	READY green	WARNING TEMP red	LAMP REPLACE orange	
●	●	●	●	The projector is off. (The main switch is OFF position or the AC power cord is unplugged.)
○	○	●	*	The projector is in stand-by mode. Press the ON/STAND-BY button to turn on the projector.
●	○	●	*	The projector is operating normally.
○	●	●	*	The projector is preparing for stand-by or the projection lamp is being cooled down. The projector cannot be turned on until cooling is completed and the READY indicator lights green.
●	⦿	●	*	The projector is in the Power management mode.

○ ●●● on

● ●●● dim

● ●●● off

⦿ ●●● blinking at the normal rate  
(approx. 1 second ON,  
1 second OFF)

⦿ ●●● blinking fast  
(approx. 0.5 seconds ON,  
0.5 seconds OFF)

⦿ ●●● blinking slow  
(approx. 2 seconds ON,  
2 seconds OFF)

- \* When the projection lamp reaches its end of life, the LAMP REPLACE indicator lights orange. When this lights orange, replace the projection lamp a new one promptly. Reset the lamp counter after replacing the lamp (p.57)



The projector is detecting abnormal condition.

Indicators				Projector Condition
LAMP red	READY green	WARNING TEMP. red	LAMP REPLACE orange	
				The temperature inside the projector is elevated close to the abnormally high level.
				The temperature inside the projector is abnormally high. The projector cannot be turned on. When the projector is cooled down enough and the temperature returns to normal, the READY indicator lights green and the projector can be turned on. (The WARNING TEMP. indicator keeps blinking.) Check and clean the filter.
				The projector has been cooled down enough and the temperature returns to normal. When turning on the projector, the WARNING TEMP. indicator stops blinking. Check and clean the filter.
				Any of 4 lamps becomes out, Lamp Mode is changed over from 4 lamps to 2 lamps. And when any of 2 lamps are out, a projector operates with 1 lamp.
				The lamp has been used overtime. Replace the lamp immediately and then reset the lamp counter. The indicator will be turned off after resetting the counter.
				The projector detects an abnormal condition and cannot be turned on. Unplug the AC power cord and plug it again to turn on the projector. If the projector is turned off again, unplug the AC power cord and contact the dealer or the service center. Do not leave the projector on. It may cause an electric shock or a fire hazard.

## Compatible Computer Specifications

Basically this projector can accept the signal from all computers with the V- and H-Frequency mentioned below and less than 230 MHz of Dot Clock.

PC Adjustment is limited when selecting these modes.

ON-SCREEN DISPLAY	RESOLUTION	H-Freq.(kHz)	V-Freq.(Hz)
VGA 1	640x480	31.470	59.880
VGA 2	720x400	31.470	70.090
VGA 3	640x400	31.470	70.090
VGA 4	640x480	37.860	74.380
VGA 5	640x480	37.860	72.810
VGA 6	640x480	37.500	75.000
VGA 7	640x480	43.269	85.000
MAC LC13	640x480	34.970	66.600
MAC 13	640x480	35.000	66.670
480p	640x480	31.470	59.880
575p	768x575	31.250	50.000
575i	768x576 (Interlace)	15.625	50.000
480i	640x480 (Interlace)	15.734	60.000
SVGA 1	800x600	35.156	56.250
SVGA 2	800x600	37.880	60.320
SVGA 3	800x600	46.875	75.000
SVGA 4	800x600	53.674	85.060
SVGA 5	800x600	48.080	72.190
SVGA 6	800x600	37.900	61.030
SVGA 7	800x600	34.500	55.380
SVGA 8	800x600	38.000	60.510
SVGA 9	800x600	38.600	60.310
SVGA 10	800x600	32.700	51.090
SVGA 11	800x600	38.000	60.510
MAC 16	832x624	49.720	74.550
XGA 1	1024x768	48.360	60.000
XGA 2	1024x768	68.677	84.997
XGA 3	1024x768	60.023	75.030
XGA 4	1024x768	56.476	70.070
XGA 5	1024x768	60.310	74.920
XGA 6	1024x768	48.500	60.020
XGA 7	1024x768	44.000	54.580
XGA 8	1024x768	63.480	79.350
XGA 9	1024x768 (Interlace)	36.000	87.170
XGA 10	1024x768	62.040	77.070
XGA 11	1024x768	61.000	75.700
XGA 12	1024x768 (Interlace)	35.522	86.960
XGA 13	1024x768	46.900	58.200
XGA 14	1024x768	47.000	58.300
XGA 15	1024x768	58.030	72.000
MAC 19	1024x768	60.240	75.080
SXGA 1	1152x864	64.200	70.400
SXGA 2	1280x1024	62.500	58.600
SXGA 3	1280x1024	63.900	60.000
SXGA 4	1280x1024	63.340	59.980
SXGA 5	1280x1024	63.740	60.010

ON-SCREEN DISPLAY	RESOLUTION	H-Freq.(kHz)	V-Freq.(Hz)
SXGA 6	1280x1024	71.690	67.190
SXGA 7	1280x1024	81.130	76.107
SXGA 8	1280x1024	63.980	60.020
SXGA 9	1280x1024	79.976	75.025
SXGA 10	1280x960	60.000	60.000
SXGA 11	1152x900	61.200	65.200
SXGA 12	1152x900	71.400	75.600
SXGA 13	1280x1024 (Interlace)	50.000	86.000
SXGA 14	1280x1024 (Interlace)	50.000	94.000
SXGA 15	1280x1024	63.370	60.010
SXGA 16	1280x1024	76.970	72.000
SXGA 17	1152x900	61.850	66.000
SXGA 18	1280x1024 (Interlace)	46.430	86.700
SXGA 19	1280x1024	63.790	60.180
SXGA 20	1280x1024	91.146	85.024
SXGA+ 1	1400x1050	63.970	60.190
SXGA+ 2	1400x1050	65.350	60.120
SXGA+ 3	1400x1050	65.120	59.900
SXGA+ 4	1400x1050	64.030	60.010
SXGA+ 5	1400x1050	62.500	58.600
MAC 21	1152x870	68.680	75.060
MAC	1280x960	75.000	75.080
MAC	1280x1024	80.000	75.080
WXGA 1	1366x768	48.360	60.000
WXGA 2	1360x768	47.700	60.000
WXGA 3	1376x768	48.360	60.000
WXGA 4	1360x768	56.160	72.000
WXGA 6	1280x768	47.776	59.870
WXGA 7	1280x768	60.289	74.893
WXGA 8	1280x768	68.633	84.837
WXGA 9	1280x800	49.600	60.050
WXGA 10	1280x800	41.200	50.000
UXGA 1	1600x1200	75.000	60.000
UXGA 2	1600x1200	81.250	65.000
UXGA 3	1600x1200	87.500	70.000
UXGA 4	1600x1200	93.750	75.000
UXGA 5	1600x1200	106.250	85.000
720p	1280x720	45.000	60.000
720p	1280x720	37.495	50.000
1035i	1920x1035 (Interlace)	33.750	60.000
1080i	1920x1080 (Interlace)	33.750	60.000
	1920x1080 (Interlace)	28.125	50.000

\*  
\*  
\*  
\*

\* True cannot be selected when UXGA2, UXGA3, UXGA4 and UXGA5 are selected (p.38)

When an input signal is digital from the DVI terminal, refer to the chart below.

ON-SCREEN DISPLAY	RESOLUTION	H-Freq.(kHz)	V-Freq.(Hz)
D-VGA	640x480	31.470	59.940
D-480p	720x480	31.470	59.880
D-575p	720x575	31.250	50.000
D-SVGA	800x600	37.879	60.320
D-XGA	1024x768	43.363	60.000
D-WXGA 1	1366x768	48.360	60.000
D-WXGA 2	1360x768	47.700	60.000
D-WXGA 3	1376x768	48.360	60.000
D-WXGA 4	1360x768	56.160	72.000
D-WXGA 5	1366x768	46.500	50.000
D-WXGA 6	1280x768	47.776	59.870
D-WXGA 7	1280x768	60.289	74.893
D-WXGA 8	1280x768	68.633	84.837
D-WXGA 9	1280x800	49.600	60.050
D-WXGA 10	1280x800	41.200	50.000

ON-SCREEN DISPLAY	RESOLUTION	H-Freq.(kHz)	V-Freq.(Hz)
D-SXGA 1	1280x1024	63.980	60.020
D-SXGA 2	1280x1024	60.276	58.069
D-SXGA+ 1	1400x1050	63.970	60.190
D-SXGA+ 2	1400x1050	65.350	60.120
D-SXGA+ 3	1400x1050	65.120	59.900
D-720p	1280x720	45.000	60.000
D-720p	1280x720	37.500	50.000
D-1035i	1920x1035 (Interface)	33.750	60.000
D-1080i	1920x1080 (Interface)	33.750	60.000
	1920x1080 (Interface)	28.125	50.000
D-1080psf/30	1920x1080	33.750	60.000
D-1080psf/25	1920x1080	28.125	50.000
D-1080psf/24	1920x1080	27.000	48.000

**✓ Note:**

- Depending on the condition of signals and the type and length of cables, these signals may not be properly viewed.
- Specifications are subject to change without notice.

## Technical Specifications

### Mechanical Information

---

Projector Type	Multi-media Projector
Dimensions (W x H x D)	22.87" x 9.902" x 32.11" (581 mm x 251.5 mm x 815.5 mm) (Not including adjustable feet)
Net Weight	80.3 lbs (36.5 kg)
Feet Adjustment	0° to 5.7°

### Panel Resolution

---

LCD Panel System	1.8" TFT Active Matrix type, 3 panels
Panel Resolution	1,024 x 768 dots
Number of Pixels	2,359,296 (1,024 x 768 x 3 panels)

### Signal Compatibility

---

Color System	PAL, SECAM, NTSC, NTSC4.43, PAL-M, and PAL-N
High Definition TV Signal	480i, 480p, 575i, 575p, 720p, 1035i, and 1080i
Scanning Frequency	H-sync. 15 kHz–120 kHz, V-sync. 48 Hz–120 Hz

### Optical Information

---

Projection Lamp	330 W NSHA lamp x 4
-----------------	---------------------

### Interface

---

Input 1	DVI-D Terminal (Digital), D-Sub 15-pin Terminal (Analog)
Input 2	BNC Type x 5 (R/Pr, G/Y, B/Pb, H/HV and V), S-Video
Other Jacks	Serial port in (D-sub 9), Serial port out (D-sub 9), USB port, and Wired Remote Jack

### Power

---

Voltage and Power Consumption	AC 240 V (9.7A Max. Ampere), 50/60 Hz (The U.S.A and Canada) AC 200–240 V (9.7A Max. Ampere), 50/60 Hz (Continental Europe and The U.K.)
-------------------------------	---

### Operating Environment

---

Operating Temperature	41°F–95°F (5°C–35°C)
Storage Temperature	14°F–140°F (-10°C–60°C)

### Remote Control

---

Battery	AA or LR6 Type x 2
Operating Range	16.4' (5 m/±30°)
Dimensions	1.97" (W) x 1.06" (H) x 6.61" (D) (50 mm x 27 mm x 168 mm)
Net Weight	4.6 oz (129 g) (including batteries)

### Accessories

---

Owner's Manual (CD-ROM)
Quick Reference Guide
AC Power Cord
Remote Control and Batteries
VGA cable
PIN Code Label
Lens Attachments (2 types) (For option lens)
Light Block Plates (3 types) (For option lens)
Spacer (For option lens)
Real Color Manager Pro (CD-ROM)

- The specifications are subject to change without notice.
- LCD panels are manufactured to the highest possible standards. Even though 99.99% of the pixels are effective, a tiny fraction of the pixels (0.01% or less) may be ineffective by the characteristics of the LCD panels.
- Each projector has its own characteristics.  
When projecting with several projectors on the same screen or side by side, you may recognize different white balance and color uniformity on each projector.

### ***Optional Parts***

The parts listed below are optionally available. When ordering those parts, specify the item name and Model No. to the sales dealer.

	<i>Model No.</i>
<b><i>Wired Remote Cable(30m)</i></b>	<i>: POA-CA-RC30</i>
<b><i>Option Slot Board (DVI)</i></b>	<i>: POA-MD18DVI</i>
<b><i>Option Slot Board (5-BNC)</i></b>	<i>: POA-MD16DVI</i>
<b><i>Option Slot Board (D-sub 15)</i></b>	<i>: POA-MD04VGA</i>
<b><i>Option Slot Board (Dual-SDI)</i></b>	<i>: POA-MD17SDID</i>
<b><i>Option Slot Board (Network board)</i></b>	<i>: POA-MD13NET2</i>

## Configurations of Terminals

### ANALOG (Mini D-sub 15 pin)

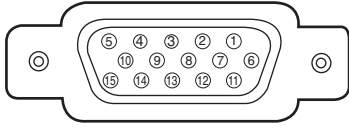

1	Red Input	9	+5V Power
2	Green Input	10	Ground (Vert. sync.)
3	Blue Input	11	Sense 0
4	Sense 2	12	DDC Data
5	Ground (Horiz.sync.)	13	Horiz. sync.
6	Ground (Red)	14	Vert. sync.
7	Ground (Green)	15	DDC Clock
8	Ground (Blue)		

### DIGITAL DVI-D (DVI 24 PIN)

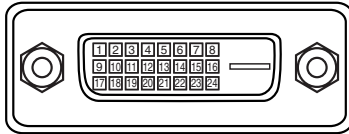

1	T.M.D.S. Data2-	9	T.M.D.S. Data1-	17	T.M.D.S. Data0-
2	T.M.D.S. Data2+	10	T.M.D.S. Data1+	18	T.M.D.S. Data0+
3	T.M.D.S. Data2 Shield	11	T.M.D.S. Data1 Shield	19	T.M.D.S. Data0 Shield
4	No Connect	12	No Connect	20	No Connect
5	No Connect	13	No Connect	21	No Connect
6	DDC Clock	14	+5V Power	22	T.M.D.S. Clock Shield
7	DDC Data	15	Ground (for +5V)	23	T.M.D.S. Clock+
8	No Connect	16	Hot Plug Detect	24	T.M.D.S. Clock-

### USB CONNECTOR (Series B)

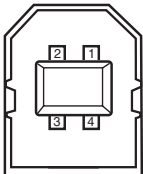

1	Vcc
2	- Data
3	+ Data
4	Ground

### CONTROL PORT CONNECTOR (D-sub 9 pin)

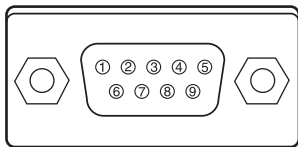

	Serial
1	---
2	R X D
3	T X D
4	---
5	SG
6	---
7	RTS
8	CTS
9	---

### ***PIN Code Number Memo***

Write down the PIN code number in the column below and keep it with this manual securely. If you forgot or lost the number and unable to operate the projector, contact the service station.

<b><i>PIN Code Lock No.</i></b>	<table border="1"> <tr> <td style="width: 30px; height: 30px;"></td> <td style="width: 30px; height: 30px;"></td> <td style="width: 30px; height: 30px;"></td> <td style="width: 30px; height: 30px;"></td> </tr> </table>				
	<b><i>Factory default set No: 1 2 3 4*</i></b>				
<b><i>Logo PIN Code Lock No.</i></b>	<table border="1"> <tr> <td style="width: 30px; height: 30px;"></td> <td style="width: 30px; height: 30px;"></td> <td style="width: 30px; height: 30px;"></td> <td style="width: 30px; height: 30px;"></td> </tr> </table>				
	<b><i>Factory default set No: 4 3 2 1*</i></b>				
	<p><i>*Should the four-digit number be changed, the factory set number will be invalid.</i></p>				

While the projector is locked with the PIN code...

Put the label below (supplied) on in a prominent place of the projector's body while it is locked with a PIN code.

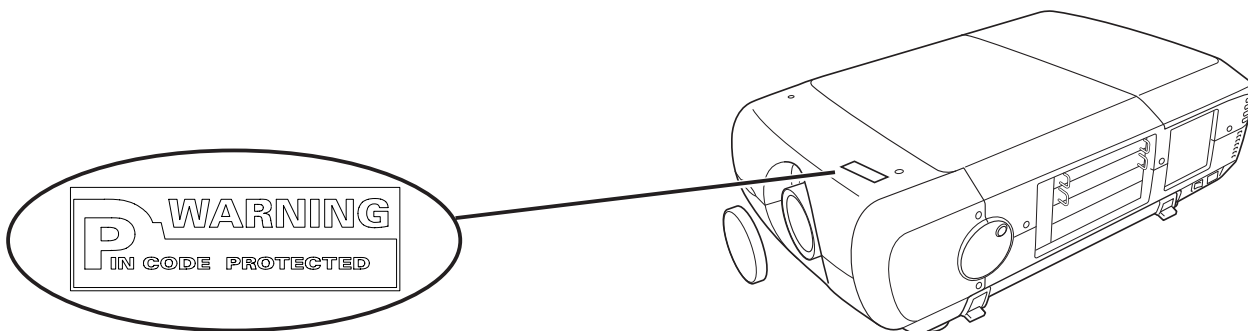

## Dimensions

Unit: inch (mm)

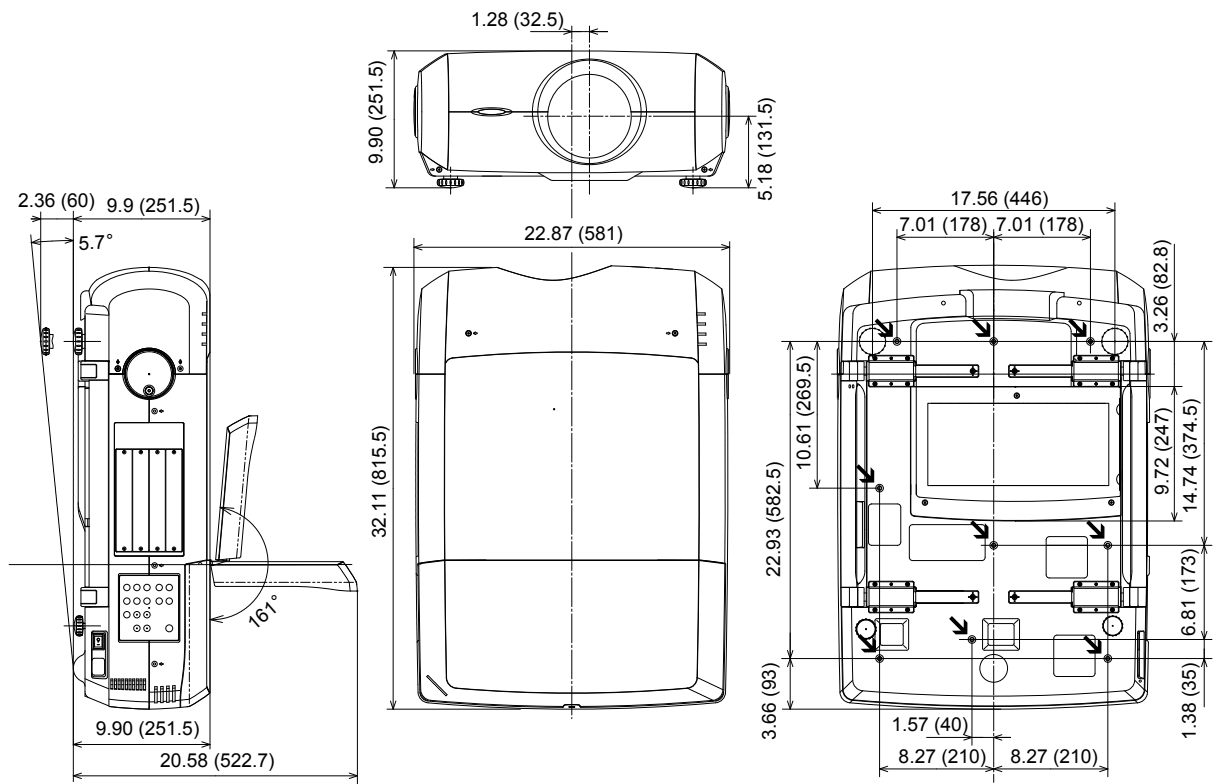



## Serial Control Interface

This projector provides a function to control and monitor the projector's operations by using the RS-232C serial port.

### Operation

- 1** Connect a RS-232C serial cross cable to SERIAL PORT IN on the projector and serial port on the PC. (See p.11)
- 2** Launch a communication software provided with PC and setup the communication condition as follows:
- 3** Type the command for controlling the projector and then enter the "Enter" key.

#### Example

When you want to change the input to INPUT 2, Type 'C' '0' '6' 'Enter'.

Baud rate	: 9600 / 19200 bps
Parity check	: none
Stop bit	: 1
Flow control	: none
Data bit	: 8

#### ✓Note:

- *The default of the baud rate is set to 19200 bps. If an error occurs in the communication, change the serial port and the communication speed (baud rate).*
- *Enter with ASCII 64-byte capital characters and one-byte characters.*

## Functional Execution Command

### Format

The command is sent from PC to the projector with the format below;

'C' [Command] 'CR'

Command: two characters (refer to the command table below).

-The projector decodes the command and returns the 'ACK' with the format below;

'ACK' 'CR'

-When the projector can not decode the command, it returns with format below.

'?' 'CR'

Command	Function
C00	Turn the projector ON
C01	Turn the projector OFF (immediately OFF)
C05	Select Input 1
C06	Select Input 2
C07	Select Input 3
C08	Select Input 4
C0D	Video mute ON
C0E	Video mute OFF
C0F	Aspect 4:3
C10	Aspect 16:9
C1C	Menu ON
C1D	Menu OFF
C3A	Pointer RIGHT

Command	Function
C3B	Pointer LEFT
C3C	Pointer UP
C3D	Pointer DOWN
C3F	Enter
C46	Zoom DOWN
C47	Zoom UP
C4A	Focus DOWN
C4B	Focus UP
C5D	Lens shift UP
C5E	Lens shift DOWN
C5F	Lens shift LEFT
C60	Lens shift RIGHT
C89	Auto PC Adj.
C8E	Keystone UP
C8F	Keystone DOWN
C90	Keystone RIGHT
C91	Keystone LEFT

## Status Read Command

### Format

The command is sent from PC to the projector with the format below;

'CR' [Command] 'CR'

Command: one character (refer to the command table below).

The projector decodes the command and returns the 'Character string' with the format below;

Command	Function	Projector Return	Projector status
CR0	Status Read	00	Power On
		80	Stand-by mode
		40	Countdown
		20	Cooling down
		10	Power Malfunction
		28	Cooling down at the temperature anomaly
		02	Unable to receive the RC232C command.
		24	Cooling down at Power Management mode
		04	Power Management mode after Cooling down
		21	Cooling down after the projector is turned off when the lamps are out.
		81	Stand-by mode after Cooling down when the lamps are out.
		88	Stand-by mode after Cooling down at the temperature anomaly.
CR6	Temperature Read	S1 S2 S3	S1 = Temperature at Sensor 1 (°C) S2 = Temperature at Sensor 2 (°C) S3 = Temperature at Sensor 3 (°C) (ex.) S1 = 12.3°C, S2 = 23.4°C, S3 = 34.5°C --> The projector displays "12.3 23.4 34.5" (For each sensor, two digit and the tenth place numbers are displayed with a space between each temperature.)
		?	Communication failure

The tables on page 77 and 78 show the typical command lists for controlling the projector. Please consult your local dealer for further information of other commands.



---

SANYO Electric Co., Ltd.