

# FUJIFILM

BL01622-200 **EN**

DIGITAL CAMERA

# FINEPIX F770EXR

# FINEPIX F750EXR

## Owner's Manual

Thank you for your purchase of this product. This manual describes how to use your FUJIFILM digital camera and the supplied software. Be sure that you have read and understood its contents and the warnings in "For Your Safety" (📖 ii) before using the camera.

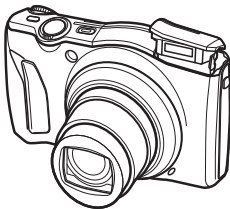

For information on related products, visit our website at [http://www.fujifilm.com/products/digital\\_cameras/index.html](http://www.fujifilm.com/products/digital_cameras/index.html)

Before You Begin

First Steps

Basic Photography and Playback

More on Photography

More on Playback

GPS

Movies

Connections

Menus

Technical Notes

Troubleshooting

Appendix



## IMPORTANT SAFETY INSTRUCTIONS

- **Read Instructions:** All the safety and operating instructions should be read before the appliance is operated.
- **Retain Instructions:** The safety and operating instructions should be retained for future reference.
- **Heed Warnings:** All warnings on the appliance and in the operating instructions should be adhered to.
- **Follow Instructions:** All operating and use instructions should be followed.

### Installation

**Power Sources:** This video product should be operated only from the type of power source indicated on the marking label. If you are not sure of the type of power supply to your home, consult your appliance dealer or local power company. For video products intended to operate from battery power, or other sources, refer to the operating instructions.

**Grounding or Polarization:** This video product is equipped with a polarized alternating-current line plug (a plug having one blade wider than the other). This plug will fit into the power outlet only one way. This is a safety feature. If you are unable to insert the plug fully into the outlet, try reversing the plug. If the plug should still fail to fit, contact your electrician to replace your obsolete outlet. Do not defeat the safety purpose of the polarized plug.

**Alternate Warnings:** This video product is equipped with a three-wire grounding-type plug, a plug having a third (grounding) pin. This plug will only fit into a grounding-type power outlet. This is a safety feature. If you are unable to insert the plug into the outlet, contact your electrician to replace your obsolete outlet. Do not defeat the safety purpose of the grounding type plug.

**Overloading:** Do not overload wall outlets and extension cords as this can result in a risk of fire or electric shock.

**Ventilation:** Slots and openings in the cabinet are provided for ventilation, to ensure reliable operation of the video product and to protect it from overheating, and these openings must not be blocked or covered. The openings should never be blocked by placing the video product on a bed, sofa, rug, or other similar surface.

This video product should not be placed in a built-in installation such as a bookcase or rack unless proper ventilation is provided or the manufacturer's instructions have been adhered to. This video product should never be placed near or over a radiator or heat register.

**Attachments:** Do not use attachments not recommended by the video product manufacturer as they may cause hazards.

**Water and Moisture:** Do not use this video product near water—for example, near a bath tub, wash bowl, kitchen sink, or laundry tub, in a wet basement, or near a swimming pool, and the like.

**Power-Cord Protection:** Power-supply cords should be routed so that they are not likely to be walked on or pinched by items placed upon or against them, paying particular attention to cords at plugs, convenience receptacles, and the point where they exit from the appliance.

**Accessories:** Do not place this video product on an unstable cart, stand, tripod, bracket, or table. The video product may fall, causing serious injury to a child or adult, and serious damage to the appliance. Use only with a cart, stand, tripod, bracket, or table recommended by the manufacturer, or sold with the video product. Any mounting of the appliance should follow the manufacturer's instructions, and should use a mounting accessory recommended by the manufacturer.

An appliance and cart combination should be moved with care. Quick stops, excessive force, and uneven surfaces may cause the appliance and cart combination to overturn.



**Antennas**

**Outdoor Antenna Grounding:** If an outside antenna or cable system is connected to the video product, be sure the antenna or cable system is grounded so as to provide some protection against voltage surges and built-up static charges. Section 810 of the National Electrical Code, ANSI/NFPA No. 70, provides information with respect to proper grounding of the mast and supporting structure, grounding of the lead-in wire to an antenna discharge unit, size of grounding conductors, location of antenna discharge unit, connection to grounding electrodes, and requirements for the grounding electrode.

*EXAMPLE OF ANTENNA GROUNDING AS PER NATIONAL ELECTRICAL CODE*

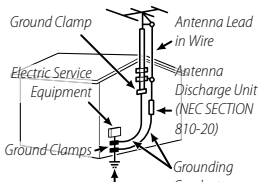

*Power Service Grounding Electrode System (NEC ART 250, PART H)*

**Power Lines:** An outside antenna system should not be located in the vicinity of overhead power lines or other electric light or power circuits, or where it can fall into such power lines or circuits. When installing an outside antenna system, extreme care should be taken to keep from touching such power lines or circuits as contact with them might be fatal.

**Use**

**Cleaning:** Unplug this video product from the wall outlet before cleaning. Do not use liquid cleaners or aerosol cleaners. Use a damp cloth for cleaning.

**Object and Liquid Entry:** Never push objects of any kind into this video product through openings as they may touch dangerous voltage points or short out parts that could result in a fire or electric shock. Never spill liquid of any kind on the video product.

**Lightning:** For added protection for this video product receiver during a lightning storm, or when it is left unattended and unused for long periods of time, unplug it from the wall outlet and disconnect the antenna or cable system. This will prevent damage to the video product due to lightning and power-line surges.

**Service**

**Servicing:** Do not attempt to service this video product yourself as opening or removing covers may expose you to dangerous voltage or other hazards. Refer all servicing to qualified service personnel.

**Damage Requiring Service:** Unplug this video product from the wall outlet and refer servicing to qualified service personnel under the following conditions:

- When the power-supply cord or plug is damaged.
- If liquid has been spilled, or objects have fallen into the video product.
- If the video product has been exposed to rain or water.
- If the video product has been dropped or the cabinet has been damaged.

If the video product does not operate nor-

mally follow the operating instructions. Ad-just only those controls that are covered by the operating instructions as an improper adjustment of other controls may result in damage and will often require extensive work by a qualified technician to restore the video product to its normal operation.

When the video product exhibits a distinct change in performance—this indicates a need for service.

**Replacement Parts:** When replacement parts are required, be sure the service technician has used replacement parts specified by the manufacturer or have the same characteristics as the original part. Unauthorized substitutions may result in fire, electric shock or other hazards.

**Safety Check:** Upon completion of any service or repairs to this video product, ask the service technician to perform safety checks to determine that the video product is in proper operating condition.

**Be sure to read these notes before use**

**Safety Notes**

- Make sure that you use your camera correctly. Read these safety notes and your *Owner's Manual* carefully before use.
- After reading these safety notes, store them in a safe place.

**About the Icons**

The icons shown below are used in this document to indicate the severity of the injury or damage that can result if the information indicated by the icon is ignored and the product is used incorrectly as a result.



This icon indicates that death or serious injury can result if the information is ignored.



This icon indicates that personal injury or material damage can result if the information is ignored.

The icons shown below are used to indicate the nature of the instructions which are to be observed.



Triangular icons tell you that this information requires attention ("Important").



Circular icons with a diagonal bar tell you that the action indicated is prohibited ("Prohibited").



Filled circles with an exclamation mark indicate an action that must be performed ("Required").

**WARNING**



Unplug from power source

***If a problem arises, turn the camera off, remove the battery, and disconnect and unplug the AC power adapter.*** Continued use of the camera when it is emitting smoke, is emitting any unusual odor, or is in any other abnormal state can cause a fire or electric shock. Contact your FUJIFILM dealer.



Avoid exposure to water

***Do not allow water or foreign objects to enter the camera.*** If water or foreign objects get inside the camera, turn the camera off, remove the battery, and disconnect and unplug the AC power adapter. Continued use of the camera can cause a fire or electric shock. Contact your FUJIFILM dealer.

**WARNING**



Do not use in the bathroom or shower

***Do not use the camera in the bathroom or shower.*** This can cause a fire or electric shock.



Do not disassemble

***Never attempt to change or take apart the camera (never open the case).*** Failure to observe this precaution can cause fire or electric shock.



Do not touch internal parts

***Should the case break open as the result of a fall or other accident, do not touch the exposed parts.*** Failure to observe this precaution could result in electric shock or in injury from touching the damaged parts. Remove the battery immediately, taking care to avoid injury or electric shock, and take the product to the point of purchase for consultation.



***Do not change, heat or unduly twist or pull the connection cord and do not place heavy objects on the connection cord.*** These actions could damage the cord and cause a fire or electric shock. If the cord is damaged, contact your FUJIFILM dealer.



***Do not place the camera on an unstable surface.*** This can cause the camera to fall or tip over and cause injury.



***Never attempt to take pictures while in motion.*** Do not use the camera while you are walking or driving a vehicle. This can result in you falling down or being involved in a traffic accident.



***Do not touch any metal parts of the camera during a thunderstorm.*** This can cause an electric shock due to induced current from the lightning discharge.



***Do not use the battery except as specified.*** Load the battery as shown by the indicator.









***Do not heat, change or take apart the battery. Do not drop or subject the battery to impacts. Do not store the battery with metallic products.*** Any of these actions can cause the battery to burst or leak and cause fire or injury as a result.



















***Use only the battery or AC power adapters specified for use with this camera. Do not use voltages other than the power supply voltage shown.*** The use of other power sources can cause a fire.



***If the battery leaks and fluid gets in contact with your eyes, skin or clothing, flush the affected area with clean water and seek medical attention or call an emergency number right away.***

 <b>WARNING</b>	
	<b>Do not use the charger to charge batteries other than those specified here.</b> The supplied battery charger is for use only with the type of battery supplied with the camera. Using the charger to charge conventional batteries or other types of rechargeable batteries can cause the battery to leak fluid, overheat or burst.
	<b>Danger of explosion if battery is incorrectly replaced. Replace only with the same or equivalent type.</b>
	<b>Do not use in the presence of flammable objects, explosive gases, or dust.</b>
	<b>When carrying the battery, install it in a digital camera or keep it in the hard case. When storing the battery, keep it in the hard case. When discarding, cover the battery terminals with insulation tape.</b> Contact with other metallic objects or batteries could cause the battery to ignite or burst.
	<b>Keep memory cards out of the reach of small children.</b> Because memory cards are small, they can be swallowed by children. Be sure to store memory cards out of the reach of small children. If a child swallows a memory card, seek medical attention or call an emergency number.

 <b>CAUTION</b>	
	<b>Do not use this camera in locations affected by oil fumes, steam, humidity or dust.</b> This can cause a fire or electric shock.
	<b>Do not leave this camera in places subject to extremely high temperatures.</b> Do not leave the camera in locations such as a sealed vehicle or in direct sunlight. This can cause a fire.
	<b>Keep out of the reach of small children.</b> This product could cause injury in the hands of a child.
	<b>Do not place heavy objects on the camera.</b> This can cause the heavy object to tip over or fall and cause injury.
	<b>Do not move the camera while the AC power adapter is still connected. Do not pull on the connection cord to disconnect the AC power adapter.</b> This can damage the power cord or cables and cause a fire or electric shock.
	<b>Do not use the AC power adapter when the plug is damaged or the plug socket connection is loose.</b> This could cause a fire or electric shock.

 <b>CAUTION</b>	
	<b>Do not cover or wrap the camera or the AC power adapter in a cloth or blanket.</b> This can cause heat to build up and distort the casing or cause a fire.
	<b>When you are cleaning the camera or you do not plan to use the camera for an extended period, remove the battery and disconnect and unplug the AC power adapter.</b> Failure to do so can cause a fire or electric shock.
	<b>When charging ends, unplug the charger from the power socket.</b> Leaving the charger plugged into the power socket can cause a fire.
	<b>Using a flash too close to a person's eyes may temporarily affect the eyesight.</b> Take particular care when photographing infants and young children.
	<b>When a memory card is removed, the card could come out of the slot too quickly. Use your finger to hold it and gently release the card.</b> Injury could result to those struck by the ejected card.
	<b>Request regular internal testing and cleaning for your camera.</b> Build-up of dust in your camera can cause a fire or electric shock. Contact your FUJIFILM dealer to request internal cleaning every two years. Please note that this service is free of charge.
	<b>Remove your fingers from the flash window before the flash fires.</b> Failure to observe this precaution could result in burns.
	<b>Keep the flash window clean and do not use the flash if the window is obstructed.</b> Failure to observe these precautions could cause smoke or discoloration.

### The Battery and Power Supply

**Note:** Check the type of battery used in your camera and read the appropriate sections.

The following describes the proper use of batteries and how to prolong their life. Incorrect use can shorten battery life or cause leakage, overheating, fire, or explosion.

#### Li-ion Batteries

*Read this section if your camera uses a rechargeable Li-ion battery.*

The battery is not charged at shipment. Charge the battery before use. Keep the battery in its case when not in use.

#### Notes on the Battery

The battery gradually loses its charge when not in use. Charge the battery one or two days before use.

Battery life can be extended by turning the camera off when not in use.

Battery capacity decreases at low temperatures; a depleted battery may not function at when cold. Keep a fully charged spare battery in a warm place and exchange as necessary, or keep the battery in your pocket or other warm place and insert it in the camera only when shooting. Do not place the battery in direct contact with hand warmers or other heating devices.

#### Charging the Battery

Charge the battery in the supplied battery charger. Charging times will increase at ambient temperatures below +10°C (+50°F) or above +35°C (+95°F). Do not attempt to charge the battery at temperatures above 40°C (+104°F); at temperatures below 0°C (+32°F), the battery will not charge.

Do not attempt to recharge a fully charged battery. The battery does not however need to be fully discharged before charging.

The battery may be warm to the touch immediately after charging or use. This is normal.

#### Battery Life

At normal temperatures, the battery can be recharged about 300 times. A noticeable decrease in the length of time the battery will hold a charge indicates that it has reached the end of its service life and should be replaced.

#### Storage

Performance may be impaired if the battery is left unused for extended periods when fully charged. Run the battery flat before storing it. If the camera will not be used for an extended period, remove the battery and store it in a dry place with an ambient temperature of from +15°C to +25°C (+59°F to +77°F). Do not store in locations exposed to extremes of temperature.

#### Cautions: Handling the Battery

- Do not transport or store with metal objects such as necklaces or hairpins.
- Do not expose to flame or heat.
- Do not disassemble or modify.
- Use with designated chargers only.
- Do not drop or subject to strong physical shocks.
- Do not expose to water.
- Keep the terminals clean.
- The battery and camera body may become warm to the touch after extended use. This is normal.

#### AA Alkaline/Rechargeable Ni-MH Batteries

*Read this section if your camera uses AA alkaline or rechargeable AA Ni-MH batteries.* Information on compatible battery types may be found elsewhere in the camera manual.

#### Cautions: Handling the Batteries

- Do not expose to water, flame, or heat, or store in warm or humid conditions.
- Do not transport or store with metal objects such as necklaces or hairpins.
- Do not disassemble or modify the batteries or battery casing.
- Do not subject to strong physical shocks.
- Do not use batteries that are leaking, deformed, or discolored.
- Keep out of reach of infants and small children.
- Insert in the correct orientation.

- Do not mix old and new batteries, batteries with different charge levels, or batteries of different types.
- If the camera will not be used for an extended period, remove the batteries. Note that the camera clock will be reset.
- The batteries may be warm to the touch immediately after use. Turn the camera off and allow the batteries to cool before handling.
- Battery capacity tends to decrease at low temperatures. Keep spare batteries in a pocket or other warm place and exchange as necessary. Cold batteries may recover some of their charge when warmed.
- Fingerprints and other stains on the battery terminals can impair battery performance. Thoroughly clean the terminals with a soft, dry cloth before inserting them in the camera.



If the batteries leak, clean the battery compartment thoroughly before inserting new batteries.



If fluid from the battery comes into contact with skin or clothing, flush the affected area with water. ***If fluid enters your eyes, immediately flush the affected area with water and seek medical attention. Do not rub your eyes. Failure to observe this precaution could result in permanent visual impairment.***

#### ■ Ni-MH Batteries

The capacity of Ni-MH batteries may be temporarily reduced when new, after long periods of disuse, or if they are repeatedly recharged before being fully discharged. This is normal and does not indicate a malfunction. Capacity can be increased by repeatedly discharging the batteries using the discharge option in the camera setup menu and recharging them using a battery charger.

ⓘ **CAUTION:** Do not use the discharge option with alkaline batteries.

The camera draws a small amount of current even when off. Ni-MH batteries that have been left in the camera for an extended period may be drawn down to the point that they no longer hold a charge. Battery performance may also drop if the batteries are run down in a device such as a flashlight. Use the discharge option in the camera setup menu to discharge Ni-MH batteries. Batteries that no longer hold a charge even after repeatedly being discharged and recharged have reached the end of their service life and must be replaced.

Ni-MH batteries can be recharged in a battery charger (sold separately). Batteries may become warm to the touch after charging. Refer to the instructions provided with the charger for more information. Use the charger with compatible batteries only.

Ni-MH batteries gradually lose their charge when not in use.

#### ■ Disposal

Dispose of used batteries in accord with local regulations.

#### AC Power Adapters (Available Separately)

*This section applies to all camera models.*

Use only FUJIFILM AC power adapters designated for use with this camera. Other adapters could damage the camera.

- The AC power adapter is for indoor use only.
- Be sure the DC plug is securely connected to the camera.
- Turn the camera off before disconnecting the adapter. Disconnect the adapter by the plug, not the cable.
- Do not use with other devices.
- Do not disassemble.
- Do not expose to high heat and humidity.
- Do not subject to strong physical shocks.
- The adapter may hum or become hot to the touch during use. This is normal.
- If the adapter causes radio interference, reorient or relocate the receiving antenna.

### Using the Camera

Do not aim the camera at extremely bright light sources, such as the sun in a cloudless sky. Failure to observe this precaution could damage the camera image sensor.

### Take Test Shots

Before taking photographs on important occasions (such as at weddings or before taking the camera on a trip), take a test shot and view the result in the LCD monitor to ensure that the camera is functioning normally. FUJIFILM Corporation can not accept liability for damages or lost profits incurred as a result of product malfunction.

### Notes on Copyright

Unless intended solely for personal use, images recorded using your digital camera system cannot be used in ways that infringe copyright laws without the consent of the owner. Note that some restrictions apply to the photographing of stage performances, entertainments, and exhibits, even when intended purely for personal use. Users are also asked to note that the transfer of memory cards containing images or data protected under copyright laws is only permissible within the restrictions imposed by those copyright laws.

### Handling

To ensure that images are recorded correctly, do not subject the camera to impact or physical shocks while images are being recorded.

### Liquid Crystal

In the event that the LCD monitor is damaged, care should be taken to avoid contact with liquid crystal. Take the urgent action indicated should any of the following situations arise:

- **If liquid crystal comes in contact with your skin**, clean the area with a cloth and then wash thoroughly with soap and running water.
- **If liquid crystal enters your eyes**, flush the affected eye with clean water for at least 15 minutes and then seek medical assistance.
- **If liquid crystal is swallowed**, rinse your mouth thoroughly with water. Drink large quantities of water and induce vomiting, then seek medical assistance.

Although the display is manufactured using extremely high-precision technology, it may contain pixels that are always lit or that do not light. This is not a malfunction, and images recorded with the product are unaffected.

### Trademark Information

*xD-Picture Card* and *.xP* are trademarks of FUJIFILM Corporation. The typefaces included herein are solely developed by Dyna-Comware Taiwan Inc. Macintosh, QuickTime, and Mac OS are trademarks of Apple Inc. in the U.S.A. and other countries. Windows 7, Windows Vista, and the Windows logo are trademarks of the Microsoft group of companies. Adobe and Adobe Reader are either trademarks or registered trademarks of Adobe Systems Incorporated in the U.S.A. and/or other countries. The SDHC and SDXC logos are trademarks of SD-3C, LLC. The HDMI logo is a trademark. YouTube is a trademark of Google Inc. All other trade names mentioned in this manual are the trademarks or registered trademarks of their respective owners.

### Electrical Interference

This camera may interfere with hospital or aviation equipment. Consult with hospital or airline staff before using the camera in a hospital or on an aircraft.

### Color Television Systems

NTSC (National Television System Committee) is a color television telecasting specification adopted mainly in the U.S.A., Canada, and Japan. PAL (Phases Alternation by Line) is a color television system adopted mainly in European countries and China.

### Exif Print (Exif Version 2.3)

Exif Print is a newly revised digital camera file format in which information stored with photographs is used for optimal color reproduction during printing.

### IMPORTANT NOTICE: Read Before Using the Software

Direct or indirect export, in whole or in part, of licensed software without the permission of the applicable governing bodies is prohibited.



**IMPORTANT:** Read this section before using the toponyms included in this product.

#### Toponym Data License Agreement

**Personal Use Only.** You agree to use this Data together with this digital camera for the solely personal, non-commercial purposes for which you were licensed, and not for service bureau, time-sharing or other similar purposes. Accordingly, but subject to the restrictions set forth in the following paragraphs, you may copy this Data only as necessary for your personal use to (i) view it, and (ii) save it, provided that you do not remove any copyright notices that appear and do not modify the Data in any way. You agree not to otherwise reproduce, copy, modify, decompile, disassemble or reverse engineer any portion of this Data, and may not transfer or distribute it in any form, for any purpose, except to the extent permitted by mandatory laws. Multi-disc sets may only be transferred or sold as a complete set as provided by FUJIFILM Corporation and not as a subset thereof.

**Restrictions.** Except where you have been specifically licensed to do so by FUJIFILM Corporation, and without limiting the preceding paragraph, you may not (a) use this Data with any products, systems, or applications installed or otherwise connected to or in communication with vehicles, capable of vehicle navigation, positioning, dispatch, real time route guidance, fleet management or similar applications; or (b) with or in communication with any positioning devices or any mobile or wireless-connected electronic or computer devices, including without limitation cellular phones, palmtop and handheld computers, pagers, and personal digital assistants or PDAs.

**Warning.** The Data may contain inaccurate or incomplete information due to the passage of time, changing circumstances, sources used and the nature of collecting comprehensive geographic data, any of which may lead to incorrect results.

**No Warranty.** This Data is provided to you "as is," and you agree to use it at your own risk. FUJIFILM Corporation and its licensors (and their licensors and suppliers) make no guarantees, representations or warranties of any kind, express or implied, arising by law or otherwise, including but not limited to, content, quality, accuracy, completeness, effectiveness, reliability, fitness for a particular purpose, usefulness, use or results to be obtained from this Data, or that the Data or server will be uninterrupted or error-free.

**Disclaimer of Warranty.** FUJIFILM Corporation AND ITS LICENSORS (INCLUDING THEIR LICENSORS AND SUPPLIERS) DISCLAIM ANY WARRANTIES, EXPRESS OR IMPLIED, OF QUALITY, PERFORMANCE, MERCHANTABILITY, FITNESS FOR A PARTICULAR PURPOSE OR NON-INFRINGEMENT. Some States, Territories and Countries do not allow certain warranty exclusions, so to that extent the above exclusion may not apply to you.

**Disclaimer of Liability.** FUJIFILM Corporation AND ITS LICENSORS (INCLUDING THEIR LICENSORS AND SUPPLIERS) SHALL NOT BE LIABLE TO YOU: IN RESPECT OF ANY CLAIM, DEMAND OR ACTION, IRRESPECTIVE OF THE NATURE OF THE CAUSE OF THE CLAIM, DEMAND OR ACTION ALLEGING ANY LOSS, INJURY OR DAMAGES, DIRECT OR INDIRECT, WHICH MAY RESULT FROM THE USE OR POSSESSION OF THE INFORMATION; OR FOR ANY LOSS OF PROFIT, REVENUE, CONTRACTS OR SAVINGS, OR ANY OTHER DIRECT, INDIRECT, INCIDENTAL, SPECIAL OR CONSEQUENTIAL DAMAGES ARISING OUT OF YOUR USE OR INABILITY TO USE THIS INFORMATION, ANY DEFECT IN THE INFORMATION, OR THE BREACH OF THESE TERMS OR CONDITIONS, WHETHER IN AN ACTION IN CONTRACT OR TORT OR BASED ON A WARRANTY, EVEN IF FUJIFILM Corporation OR ITS LICENSORS HAVE BEEN ADVISED OF THE POSSIBILITY OF SUCH DAMAGES. Some States, Territories and Countries do not allow certain liability exclusions or damages limitations, so to that extent the above may not apply to you.

**Export Control.** You agree not to export from anywhere any part of the Data provided to you or any direct product thereof except in compliance with, and with all licenses and approvals required under, applicable export laws, rules and regulations.

**Entire Agreement.** These terms and conditions constitute the entire agreement between FUJIFILM Corporation (and its licensors, including their licensors and suppliers) and you pertaining to the subject matter hereof, and supersedes in their entirety any and all written or oral agreements previously existing between us with respect to such subject matter.

**Goveming Law.** The above terms and conditions shall be governed by the laws of the State of Illinois, Netherlands, without giving effect to (i) its conflict of laws provisions, or (ii) the United Nations Convention for Contracts for the International Sale of Goods, which is explicitly excluded. You agree to submit to the jurisdiction of the State of Illinois, The Netherlands for any and all disputes, claims and actions arising from or in connection with the Data provided to you hereunder.

**Geodetics.** The geodetic system used by this device to record latitude and longitude is WGS 84.

**Copyright.** The map data included in this device are protected under copyright law and except for personal use may not be employed without the permission of the copyright holder.

**Navigation.** This device can not be used for purposes of navigation.

### Licensed Software Copyright Holders



© 2010 NAVTEQ All rights reserved.



This service uses POI (Points Of Interest) of ZENRIN CO., LTD. "POWERED BY ZENRIN" is a trademark of ZENRIN CO., LTD. © 2010 ZENRIN CO., LTD. All rights reserved.

© Her Majesty the Queen in Right of Canada, © Queen's Printer for Ontario, © Canada Post Corporation, GeoBase®, © Department of Natural Resources Canada, ZIP+4®, © United States Postal Service® 2010. the USPS®.

Australia	Copyright. Based on data provided under license from PSMA Australia Limited ( <a href="http://www.pasma.com.au">www.pasma.com.au</a> ).
Austria	"© Bundesamt für Eich- und Vermessungswesen"
Croatia, Cyprus, Estonia, Latvia, Lithuania, Moldova, Poland, Slovenia and/or Ukraine	"© EuroGeographics"
France	The following notice must appear on all copies of the Data, and may also appear on packaging: "source: © IGN France – BD TOPO®"
Germany	"Die Grundlagendaten wurden mit Genehmigung der zuständigen Behörden entnommen" or "Die Grundlagendaten wurden mit Genehmigung der zustaendigen Behoerden entnommen."
Great Britain	"Based upon Crown Copyright material"
Greece	"Copyright Geomatics Ltd."
Hungary	"Copyright © 2003; Top-Map Ltd."
Italy	"La Banca Dati Italiana è stata prodotta usando quale riferimento anche cartografia numerica ed al tratto prodotta e fornita dalla Regione Toscana."
Norway	"Copyright © 2000; Norwegian Mapping Authority"
Portugal	"Source: IgeoE – Portugal"
Spain	"Información geográfica propiedad del CNIG"
Sweden	"Based upon electronic data Ö National Land Survey Sweden."
Switzerland	"Topografische Grundlage: Ö Bundesamt für Landestopographie."

**■ Governing Law**

**POI information in Japan:** The above terms and conditions shall be governed by the laws of Japan, without giving effect to (i) its conflict of laws provisions, or (ii) the United Nations Convention for Contracts for the International Sale of Goods, which is explicitly excluded. You agree to submit to the exclusive jurisdiction of the Tokyo District Court in the first instance for any and all disputes, claims and actions arising from or in connection with the Data provided to you hereunder.

**POI information outside Japan:** The above terms and conditions shall be governed by the laws of the State of Illinois, without giving effect to (i) its conflict of laws provisions, or (ii) the United Nations Convention for Contracts for the International Sale of Goods, which is explicitly excluded. You agree to submit to the jurisdiction of the State of Illinois for any and all disputes, claims and actions arising from or in connection with the Data provided to you hereunder.

**Government End Users:** If the Data is being acquired by or on behalf of the United States government or any other entity seeking or applying rights similar to those customarily claimed by the United States government, this Data is a “commercial item” as that term is defined at 48 C.F.R. (“FAR”) 2.101, is licensed in accordance with these End-User Terms, and each copy of Data delivered or otherwise furnished shall be marked and embedded as appropriate with the following “Notice of Use,” and shall be treated in accordance with such Notice:

**NOTICE OF USE**

**CONTRACTOR (MANUFACTURER/ SUPPLIER) NAME:** NAVTEQ

**CONTRACTOR (MANUFACTURER/SUPPLIER) ADDRESS:** 425 West Randolph Street, Chicago, Illinois 60606









This Data is a commercial item as defined in FAR 2.101 and is subject to these End-User Terms under which this Data was provided.

© 2010 NAVTEQ – All rights reserved.

If the Contracting Officer, federal government agency, or any federal official refuses to use the legend provided herein, the Contracting Officer, federal government agency, or any federal official must notify NAVTEQ prior to seeking additional or alternative rights in the Data.

## About This Manual

This manual is for use with FinePix F770EXR and F750EXR cameras. With the exceptions of the features listed below, operations for the two models are identical.

Feature \ Model	FinePix F770EXR	FinePix F750EXR
 <b>GPS</b>	 65	Not available
 <b>RAW</b>	 117	
 <b>BEST FRAME CAPTURE</b>	 48	
 <b>FINAL <i>n</i></b>	Not available	 48

### Memory Cards

Pictures can be stored in the camera's internal memory or on optional SD, SDHC, and SDXC memory cards ( 12), referred to in this manual as "memory cards."

Before using the camera, read this manual and the warnings in “For Your Safety” (📖 ii). For information on specific topics, consult the sources below.

**Table of Contents** ..... 📖 xv

The “Table of Contents” gives an overview of the entire manual. The principal camera operations are listed here.

**Troubleshooting** ..... 📖 124

Having a specific problem with the camera? Find the answer here.

**Warning Messages and Displays** ... 📖 131

Find out what’s behind that flashing icon or error message in the display.

 **Temperature Warning**

The camera will turn off automatically before its temperature or the temperature of the battery rise above safe limits. Pictures taken when a temperature warning is displayed may exhibit higher levels of “noise” (mottling). Turn the camera off and wait for it to cool before turning it on again.

## Frequently-Used Buttons

### ■ Turning the Camera on in Playback Mode

- ➔ When the camera is off, playback can be started by pressing the  button for about a second.

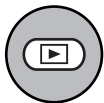

### ■ Taking Pictures During Playback

- ➔ To return instantly to shooting mode, press the shutter button halfway.

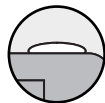

### ■ Deleting Pictures

- ➔ To delete a picture, display it full frame and press the selector up ().

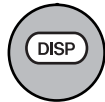
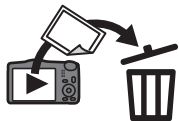

### ■ Silent Mode

- ➔ Press and hold the **DISP/BACK** button to disable camera lights and sounds.



# Table of Contents

For Your Safety .....	ii
IMPORTANT SAFETY INSTRUCTIONS .....	ii
Safety Notes .....	iv
About This Manual .....	xii
Frequently-Used Buttons .....	xiv

## Before You Begin

Symbols and Conventions .....	1
Supplied Accessories .....	1
Parts of the Camera .....	2
Camera Displays .....	4
Shooting .....	4
Playback .....	5



















## First Steps





Charging the Battery .....	7
Inserting the Battery and a Memory Card .....	9
Compatible Memory Cards .....	12
Turning the Camera on and Off .....	14
Shooting Mode .....	14
Playback Mode .....	14
Basic Setup .....	16

## Basic Photography and Playback

Taking Pictures in  (EXR AUTO) Mode .....	17
Viewing Pictures .....	21

## More on Photography

Shooting Mode .....	22
<b>EXR</b> (EXR AUTO/EXR Priority) .....	23
 (EXR AUTO) .....	23
EXR Priority .....	24
Adv. ADVANCED .....	25
 MOTION PANORAMA 360 .....	25
 PRO FOCUS .....	28
 PRO LOW-LIGHT .....	29
 MULTIPLE EXPOSURE .....	30
 INDIVID. SHUTTER 3D .....	31
SP SCENE POSITION .....	33
M MANUAL .....	35
A APERTURE PRIORITY AE .....	35
S SHUTTER PRIORITY AE .....	36
P PROGRAM AE .....	36
Focus Lock .....	37
 Exposure Compensation .....	39
 Macro Mode (Close-ups) .....	40
 Using the Flash (Super-Intelligent Flash) .....	41
 Using the Self-Timer .....	43
The Fn Button .....	44
 Intelligent Face Detection .....	45
 Continuous Shooting .....	46
 TOP <i>n</i> (F770EXR) .....	47
 TOP <i>n</i> (F750EXR) .....	47
 FINAL <i>n</i> (F750EXR Only) .....	48
 BEST FRAME CAPTURE (F770EXR Only) .....	48
 AE BKT .....	50
 FILM SIMULATION BKT .....	50
 DYNAMIC RANGE BKT .....	50

 Face Recognition .....	51
Adding New Faces .....	51
Viewing, Editing, and Deleting Existing Data .....	53
Adding Faces Automatically .....	53
<b>More on Playback</b>	
<b>Playback Options</b> .....	55
Continuous Shooting .....	55
★ Favorites: Rating Pictures .....	55
Playback Zoom .....	56
Multi-Frame Playback .....	57
 <b>Deleting Pictures</b> .....	58
 <b>Image Search</b> .....	59
 <b>PhotoBook Assist</b> .....	60
Creating a PhotoBook .....	60
Viewing Photobooks .....	61
Editing and Deleting Photobooks .....	61
<b>Viewing Panoramas</b> .....	62
<b>Viewing Photo Information</b> .....	63
<b>GPS (F770EXR Only)</b>	
<b>Recording GPS Data with Pictures</b> .....	65
<b>GPS Tracking</b> .....	67
<b>Viewing GPS Data</b> .....	69
Photo Navigation .....	69
Copying GPS Data to Other Images .....	70
 <b>Landmark Navigator</b> .....	71







**Movies**

<b>Recording Movies</b> .....	73
Movie Frame Size .....	74
<b>Viewing Movies</b> .....	75

**Connections**































<b>Viewing Pictures on TV</b> .....	76
<b>Printing Pictures via USB</b> .....	78
Printing the DPOF Print Order .....	80
<b>Viewing Pictures on a Computer</b> .....	82
Windows: Installing MyFinePix Studio .....	82
Macintosh: Installing FinePixViewer .....	85
Connecting the Camera .....	87

**Menus**

<b>Using the Menus: Shooting Mode</b> .....	90
Using the <b>F</b> -Mode Menu .....	90
<b>F</b> -Mode Menu Options .....	90
 ISO .....	90
 IMAGE SIZE .....	91
 CONTINUOUS .....	92
 LANDMARK NAVIGATOR (F770EXR Only) .....	92
 SET-UP (F770EXR Only) .....	92
 ADVANCED ANTI BLUR .....	93
 FILM SIMULATION .....	93



Using the Shooting Menu.....	94	<b>Using the Menus: Playback Mode .....</b>	<b>101</b>
Shooting Menu Options .....	94	Using the <b>F</b> -Mode Menu .....	101
<b>EXR</b> MODE .....	94	<b>F</b> -Mode Menu Options .....	101
Adv. MODE .....	94	PHOTOBOK ASSIST.....	101
SCENE POSITION.....	94	LANDMARK NAVIGATOR (F770EXR Only) .....	101
ISO.....	94	PHOTO NAVIGATION (F770EXR Only) .....	101
IMAGE SIZE.....	94	SET-UP (F770EXR Only) .....	102
IMAGE QUALITY .....	94	SLIDE SHOW .....	102
D-Rng DYNAMIC RANGE .....	95	Using the Playback Menu .....	103
FILM SIMULATION .....	95	Playback Menu Options.....	103
WHITE BALANCE .....	96	PHOTOBOK ASSIST.....	103
INTELLIGENT SHARPNESS.....	97	LANDMARK NAVIGATOR (F770EXR Only) .....	103
CONTINUOUS.....	97	LOCATION INFO COPY (F770EXR Only) .....	103
MY LANDMARK REGISTER (F770EXR Only) .....	97	PHOTO NAVIGATION (F770EXR Only) .....	103
ADVANCED ANTI BLUR .....	97	IMAGE SEARCH .....	103
FACE DETECTION .....	97	ERASE .....	103
PHOTOMETRY .....	98	MARK FOR UPLOAD TO .....	104
AF MODE.....	99	SLIDE SHOW .....	105
FACE RECOGNITION.....	99	RED EYE REMOVAL .....	105
MOVIE AF MODE.....	100	PROTECT.....	105
MOVIE MODE.....	100	CROP .....	106
STILL SHOOTING IN MOVIE .....	100	RESIZE.....	106
AE BKT EV STEPS.....	100	IMAGE ROTATE .....	107
		COPY .....	107
		VOICE MEMO .....	108
		ERASE FACE RECOG.....	108
		PRINT ORDER (DPOF).....	108
		DISP ASPECT .....	109

<b>The Setup Menu</b> .....	110	 <b>START-UP SCREEN</b> .....	119
Using the Setup Menu .....	110	 <b>DEMONSTRATION (F770EXR Only)</b> .....	119
Setup Menu Options .....	111		
 <b>DATE/TIME</b> .....	111		
 <b>TIME DIFFERENCE</b> .....	111		
 <b>言語/LANG.</b> .....	111		
 <b>SILENT MODE</b> .....	111		
 <b>RESET</b> .....	112		
 <b>FORMAT</b> .....	112		
 <b>SET-UP (F770EXR Only)</b> .....	112		
 <b>IMAGE DISP.</b> .....	113		
 <b>FRAME NO.</b> .....	113		
 <b>OPERATION VOL.</b> .....	114		
 <b>SHUTTER VOLUME</b> .....	114		
 <b>SHUTTER SOUND</b> .....	114		
 <b>PLAYBACK VOLUME</b> .....	114		
 <b>LCD BRIGHTNESS</b> .....	114		
 <b>MONITOR SUNLIGHT MODE</b> .....	114		
 <b>AUTO POWER OFF</b> .....	114		
 <b>Fn BUTTON</b> .....	114		
 <b>DUAL IS MODE</b> .....	115		
 <b>RED EYE REMOVAL</b> .....	115		
 <b>INTELLIGENT DIGITAL ZOOM</b> .....	116		
 <b>AF ILLUMINATOR</b> .....	117		
 <b>RAW (F770EXR Only)</b> .....	117		
 <b>SAVE ORG IMAGE</b> .....	117		
 <b>AUTOROTATE PB</b> .....	117		
 <b>BACKGROUND COLOR</b> .....	117		
 <b>GUIDANCE DISPLAY</b> .....	117		
 <b>VIDEO SYSTEM</b> .....	118		
 <b>POWER MANAGEMENT</b> .....	118		
 <b>DATE STAMP</b> .....	119		
		<b>Technical Notes</b>	
		Optional Accessories .....	120
		Accessories from FUJIFILM .....	121
		Caring for the Camera .....	122
		Storage and Use .....	122
		Cleaning .....	123
		Traveling .....	123
		<b>Troubleshooting</b>	
		Problems and Solutions .....	124
		Warning Messages and Displays .....	131
		<b>Appendix</b>	
		Internal Memory/Memory Card Capacity .....	135
		FinePix F770EXR .....	135
		FinePix F750EXR .....	136
		Specifications .....	137

# Before You Begin

## Symbols and Conventions

The following symbols are used in this manual:

- ⓘ : This information should be read before use to ensure correct operation.
- 📌 : Additional information that may be helpful when using the camera.
- 📖 : Other pages in this manual on which related information may be found.

Menus and other text in the displays are shown in **bold**. In the illustrations in this manual, displays may be simplified for explanatory purposes.

## Supplied Accessories

The following items are included with the camera:



Rechargeable  
battery

**F770EXR:** NP-50A  
**F750EXR:** NP-50

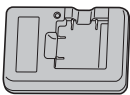

BC-45W battery  
charger



USB cable

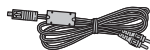

AVV cable



CD-ROM  
(contains this  
manual)

- Strap
- *Basic Manual*

### Attaching the Strap

Attach the strap  
as shown.

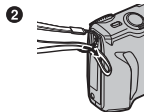
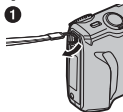

## Parts of the Camera

For more information, refer to the page listed to the right of each item.

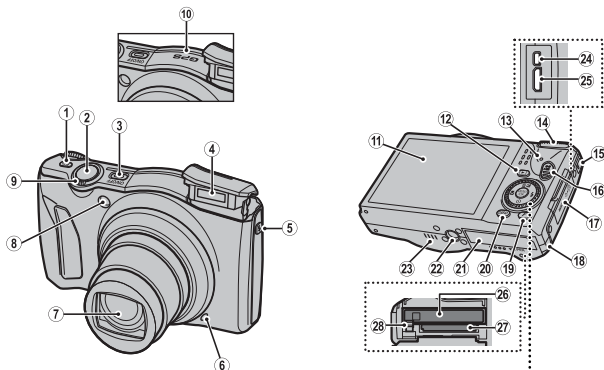

### Selector button

#### Move cursor up

 (exposure compensation) button ( 39)

 (delete) button ( xiv)

**MENU/OK button**

#### Move cursor left

 (macro) button ( 40)

#### Move cursor right





 (flash) button ( 41)

#### Command dial

#### Move cursor down

 (self-timer) button ( 43)

\* The illustrations in this manual have been simplified for explanatory purposes.

<b>1</b> Fn (function) button.....	44	<b>16</b>  (movie recording) button.....	73
<b>2</b> Shutter button.....	19	<b>17</b> Terminal cover .....	76, 78, 87
<b>3</b> <b>ON/OFF</b> button .....	14	<b>18</b> DC coupler cable cover .....	121
<b>4</b> Flash .....	41	<b>19</b>  (photo mode) button .....	90, 101
<b>5</b> Flash pop-up button.....	41	Monitor sunlight mode <sup>1</sup> .....	6
<b>6</b> Microphone .....	73, 108	<b>20</b> <b>DISP</b> (display)/ <b>BACK</b> button .....	6, 16
<b>7</b> Lens and lens cover		 (silent mode) button <sup>2</sup> .....	xiv
<b>8</b> AF-assist illuminator.....	117	<b>21</b> Battery-chamber cover.....	9
Self-timer lamp .....	43	<b>22</b> Tripod mount	
<b>9</b> Zoom control .....	18, 56	<b>23</b> Speaker.....	75, 108
<b>10</b> Built-in GPS antenna (F770EXR only) .....	65	<b>24</b> USB multi-connector .....	76, 78, 87
<b>11</b> LCD monitor .....	4	<b>25</b> Connector for HDMI cable .....	77
<b>12</b>  (playback) button .....	21	<b>26</b> Battery latch .....	9, 11
<b>13</b> Indicator lamp (see below)		<b>27</b> Battery chamber.....	9
<b>14</b> Mode dial.....	22	<b>28</b> Memory card slot.....	10
<b>15</b> Strap eyelet .....	1		

1 Press and hold the  button for monitor sunlight mode.

2 Press and hold the **DISP/BACK** button until  is displayed.

## The Indicator Lamp

The indicator lamp shows camera status as follows:

Indicator lamp	Camera status
Glows green	Focus locked.
Blinks green	Blur, focus, or exposure warning. Picture can be taken.
Blinks green and orange	Recording pictures. Additional pictures can be taken.
Glows orange	Recording pictures. No additional pictures can be taken at this time.
Blinks orange	Flash charging; flash will not fire when picture is taken.
Blinks red	Lens or memory error.

## Camera Displays

The following types of indicator may be displayed during shooting and playback. Indicators vary with camera settings.

### Shooting

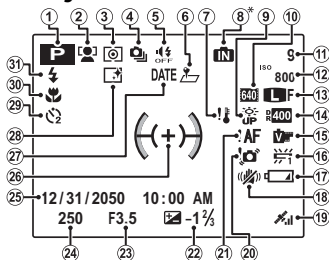

1	Shooting mode	22
2	Intelligent Face Detection indicator	45
3	Metering	98
4	Continuous shooting mode	46
5	Silent mode indicator	3, 111
6	Place name stamp (F770EXR only)	92
7	Temperature warning	131
8	Internal memory indicator*	
9	Monitor sunlight mode	6
10	Movie mode	74

11	Number of available frames	135
12	Sensitivity	90
13	Image size/quality	91, 94
14	Dynamic range	95
15	Film simulation	93
16	White balance	96
17	Battery level	6
18	Dual IS mode	115
19	GPS signal strength (F770EXR only)	65
20	Blur warning	42, 131
21	Focus warning	19, 131
22	Exposure compensation	39
23	Aperture	
24	Shutter speed	
25	Date and time	16
26	Focus frame	37
27	Date stamp	119
28	Intelligent sharpness	97
29	Self-timer indicator	43
30	Macro (close-up) mode	40
31	Flash mode	41

\* **IN**: indicates that no memory card is inserted and that pictures will be stored in the camera's internal memory (📖 10).



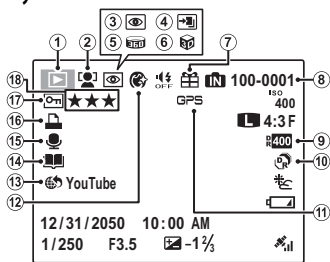

## ■ Playback



1	Playback mode indicator.....	21, 55
2	Intelligent Face Detection indicator .....	45, 105
3	Red-eye removal indicator .....	105
4	Pro focus mode, pro low-light mode.....	28, 29
5	Motion panorama .....	62
6	3D image .....	31
7	Gift image.....	55
8	Frame number .....	113
9	Dynamic range .....	95
10	<b>EXR</b> mode.....	23
11	GPS data (F770EXR only) .....	69
12	Portrait enhancer.....	33
13	Mark for upload to.....	104
14	Photobook assist.....	60
15	Voice memo indicator .....	108
16	DPOF print indicator .....	80
17	Protected image .....	105
18	Favorites .....	55



## Battery Level

Battery level is shown as follows:



Indicator	Description
 (white)	Battery partially discharged.
 (white)	Battery more than half discharged.
 (red)	Low battery. Charge as soon as possible.
 (blinks red)	Battery exhausted. Turn camera off and charge battery.

## Hiding and Viewing Indicators

Press **DISP/BACK** to cycle through shooting and playback indicators as follows:

- **Shooting:** Indicators displayed/indicators hidden/best framing/HD framing/histogram
- **Playback:** Indicators displayed/indicators hidden/★ favorites ( 55)/photo info ( 63)

## Bright Ambient Lighting

Reflections and glare caused by bright ambient lighting may make it hard to see the display in the monitor, particularly when the camera is used outdoors. This can be addressed by holding the **F** button to trigger outdoor mode. Outdoor mode can also be enabled using the  **MONITOR SUNLIGHT MODE** option in the setup menu ( 114).



# First Steps

## Charging the Battery

The battery is not charged at shipment. Charge the battery before use.

### 1 Place the battery in the supplied battery charger.

Insert the battery in the orientation indicated by the  $\ominus \text{Ⓜ} \oplus$  labels.

The F770EXR uses an NP-50A rechargeable battery, the F750EXR an NP-50 rechargeable battery.

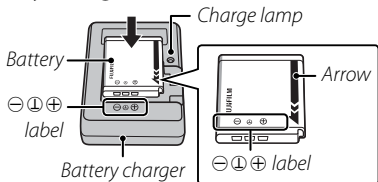

### 2 Plug the charger in.

Plug the charger into an indoor power outlet. The charging indicator will light.

#### The Charging Indicator

The charging indicator shows battery charge status as follows:

Charging indicator	Battery status	Action
Off	Battery not inserted.	Insert the battery.
	Battery fully charged.	Remove the battery.
On	Battery charging.	—
Blinks	Battery fault.	Unplug the charger and remove the battery.

### **3 Charge the battery.**

Remove the battery when charging is complete. See the specifications (📖 141) for charging times (note that charging times increase at low temperatures).

- ⓘ Unplug the charger when it is not in use.

## Inserting the Battery and a Memory Card

Although the camera can store pictures in internal memory, optional SD, SDHC, and SDXC *memory cards* (sold separately) can be used to store additional pictures. After charging the battery, insert the battery and memory card as described below.

### 1 Open the battery-chamber cover.

- ◆ Be sure the camera is off before opening the battery-chamber cover.
- ⓘ Do not open the battery-chamber cover when the camera is on. Failure to observe this precaution could result in damage to image files or memory cards.
- ⓘ Do not use excessive force when handling the battery-chamber cover.

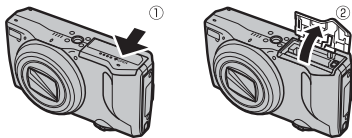

### 2 Insert the battery.

Align the orange stripe on the battery with the orange battery latch and slide the battery into the camera, keeping the battery latch pressed to one side. Confirm that the battery is securely latched.

- ⓘ Insert the battery in the correct orientation. **Do NOT use force or attempt to insert the battery upside down or backwards.** The battery will slide in easily in the correct orientation.

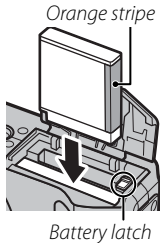

### 3 Insert the memory card.

Holding the memory card in the orientation shown at right, slide it in until it clicks into place at the back of the slot.

- ① Be sure card is in the correct orientation; do not insert at an angle or use force. If the memory card is not correctly inserted or no memory card is inserted, **IN** will appear in the LCD monitor and internal memory will be used for recording and playback.

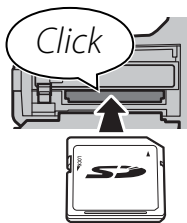

- ① SD/SDHC/SDXC memory cards can be locked, making it impossible to format the card or to record or delete images. Before inserting an SD/SDHC/SDXC memory card, slide the write-protect switch to the unlocked position.

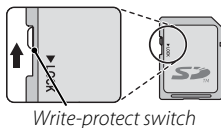

### 4 Close the battery-chamber cover.

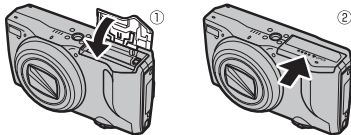

### ◆ Using an AC Power Adapter

- The camera can be powered by an optional AC power adapter and DC coupler (sold separately). See the manuals provided with the AC power adapter and DC coupler for details.
- Depending on the country or region of sale, a demo mode slide show may start if the camera is turned on while powered by an AC power adapter. Press the shutter button to end the show.

### ● Removing the Battery and Memory Card

Before removing the battery or memory card, **turn the camera off** and open the battery-chamber cover.

To remove the battery, press the battery latch to the side, and slide the battery out of the camera as shown.

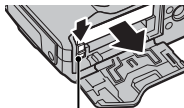

Battery latch

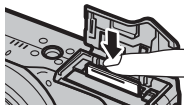

To remove the memory card, press it in and release it slowly. The card can then be removed by hand. When a memory card is removed, the card could come out of the slot too quickly. Use your finger to hold it and gently release the card.



## ■ Compatible Memory Cards

FUJIFILM and SanDisk SD, SDHC, and SDXC memory cards have been approved for use in the camera. A complete list of approved memory cards is available at [http://www.fujifilm.com/support/digital\\_cameras/compatibility/](http://www.fujifilm.com/support/digital_cameras/compatibility/). Operation is not guaranteed with other cards. The camera can not be used with *xD-Picture Cards* or MultiMediaCard (MMC) devices.

### ① Memory Cards

- *Do not turn the camera off or remove the memory card while the memory card is being formatted or data are being recorded to or deleted from the card.* Failure to observe this precaution could damage the card.
- Format SD/SDHC/SDXC memory cards before first use, and be sure to reformat all memory cards after using them in a computer or other device. For more information on formatting memory cards, see “ **FORMAT**” (📖 112).
- Memory cards are small and can be swallowed; keep out of reach of children. If a child swallows a memory card, seek medical assistance immediately.
- miniSD or microSD adapters that are larger or smaller than the standard dimensions of an SD/SDHC/SDXC card may not eject normally; if the card does not eject, take the camera to an authorized service representative. Do not forcibly remove the card.
- Do not affix labels to memory cards. Peeling labels can cause camera malfunction.
- Movie recording may be interrupted with some types of SD/SDHC/SDXC memory card. Use a **CLASS 4**  card or better when shooting HD or high-speed movies.

- The data in internal memory may be erased or corrupted when the camera is repaired. Please note that the repairer will be able to view pictures in internal memory.
- Formatting a memory card or internal memory in the camera creates a folder in which pictures are stored. Do not rename or delete this folder or use a computer or other device to edit, delete, or rename image files. Always use the camera to delete pictures from memory cards and internal memory; before editing or renaming files, copy them to a computer and edit or rename the copies, not the originals.

### ① Batteries

- Remove dirt from the battery terminals with a clean, dry cloth. Failure to observe this precaution could prevent the battery from charging.
- Do not affix stickers or other objects to the battery. Failure to observe this precaution could make it impossible to remove the battery from the camera.
- Do not short the battery terminals. The battery could overheat.
- Read the cautions in “The Battery and Power Supply” (📖 vi).
- Use only battery chargers designated for use with the battery. Failure to observe this precaution could result in product malfunction.
- Do not remove the labels from the battery or attempt to split or peel the outer casing.
- The battery gradually loses its charge when not in use. Charge the battery one or two days before use.

## Turning the Camera on and Off

### ***Shooting Mode***

Press the **ON/OFF** button to turn the camera on. The lens will extend automatically.

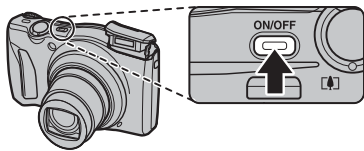

Press **ON/OFF** again to turn the camera off.

### ◆ **Switching to Playback Mode**

Press the **▶** button to start playback. Press the shutter button halfway to return to shooting mode.

### ***Playback Mode***

To turn the camera on and begin playback, press the **▶** button for about a second.

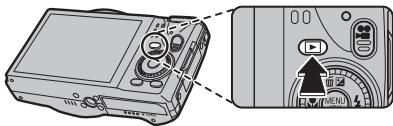

Press the **▶** button again or press the **ON/OFF** button to turn the camera off.

### ◆ **Switching to Shooting Mode**

To exit to shooting mode, press the shutter button halfway. Press the **▶** button to return to playback.





- ⓘ Forcibly obstructing the lens could cause damage or product malfunction.
- ⓘ Fingerprints and other marks on the lens can affect pictures. Keep the lens clean.
- ⓘ The **ON/OFF** button does not completely end the supply of power to the camera.

#### 🔍 **Auto Power Off**

The camera will turn off automatically if no operations are performed for the length of time selected for  **AUTO POWER OFF** (📖 114).

## Basic Setup

A language-selection dialog is displayed the first time the camera is turned on. Set up the camera as described below (you can reset the clock or change languages at any time using the  **DATE/TIME** or  **言語/LANG.** options in the setup menu; for information on displaying the setup menu, see page 111).

### 1 Highlight a language and press **MENU/OK**.

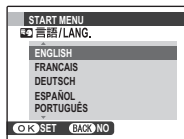

- ◆ Press **DISP/BACK** to skip the current step. Any steps you skip will be displayed the next time the camera is turned on.

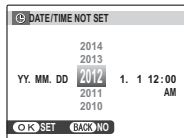

### 2 The date and time will be displayed. Press the selector left or right to highlight the year, month, day, hour, or minute and press up or down to change. To change the order in which the year, month, and day are displayed, highlight the date format and press the selector up or down. Press **MENU/OK** when settings are complete.



### 3 Power management options will be displayed. Press the selector up or down to highlight one of the following options and then press **MENU/OK**:

-  **POWER SAVE**: Save battery power.
-  **CLEAR DISPLAY**: Choose for a brighter, higher quality display.

#### ◆ The Camera Clock

If the battery is removed for an extended period, the camera clock will be reset and the language-selection dialog will be displayed when the camera is turned on.

# Basic Photography and Playback

## Taking Pictures in **EXR AUTO** (**EXR AUTO**) Mode

This section describes how to take pictures in **EXR AUTO** (**EXR AUTO**) mode.

### 1 Select **EXR** mode.

Turn the camera on and rotate the mode dial to **EXR**. The **EXR AUTO** display will appear in the LCD monitor.

#### The **Face** Icon

In **EXR AUTO** mode, the camera continuously adjusts focus and searches for faces, increasing the drain on the battery. **Face** is displayed in the LCD monitor.



#### Scene Icon (📖 23)

The camera automatically selects the appropriate scene.

- ❖ The camera analyses the scene and selects the preferred **EXR** mode when the shutter button is pressed halfway (📖 24).
- ❖ To raise the flash when lighting is poor, press the flash pop-up button (📖 41).

## 2 Frame the picture.

Use the zoom control to frame the picture in the display.

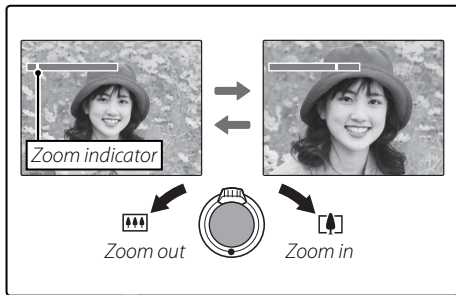

### **Holding the Camera**

Hold the camera steady with both hands and brace your elbows against your sides. Shaking or unsteady hands can blur your shots.

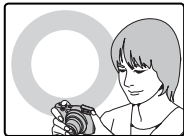

To prevent pictures that are out of focus or too dark (underexposed), keep your fingers and other objects away from the lens and flash.

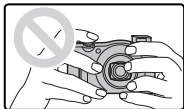

### 3 Focus.

Press the shutter button halfway to focus.

- ◆ The lens may make a noise when the camera focuses; this is normal. If the subject is poorly lit, the AF-assist illuminator may light; see “**AF-ILLUMINATOR**” (117) for information on disabling the illuminator.

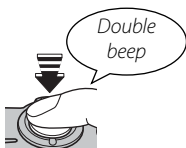

**If the camera is able to focus**, it will beep twice and the indicator lamp will glow green.

**If the camera is unable to focus**, the focus frame will turn red, **!AF** will be displayed, and the indicator lamp will blink green. Change the composition or use focus lock (37).

## 4 Shoot.

Smoothly press the shutter button the rest of the way down to take the picture.



### **The Shutter Button**

The shutter button has two positions. Pressing the shutter button halfway sets focus and exposure; to shoot, press the shutter button the rest of the way down.

## Viewing Pictures

Pictures can be viewed in the LCD monitor. When taking important photographs, take a test shot and check the results.

### 1 Press the button.

The most recent picture will be displayed.

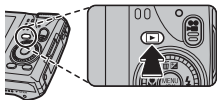

### 2 View additional pictures.

Press the selector right to view pictures in the order recorded, left to view pictures in reverse order.

Press the shutter button to exit to shooting mode.

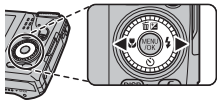

# More on Photography

## Shooting Mode

Choose a shooting mode according to the scene or type of subject. To select a shooting mode, align the mode icon with the mark next to the mode dial.

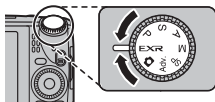

**EXR:** Improve clarity, reduce noise, increase dynamic range, or let the camera automatically adjust settings to suit the scene (📖 23).

**📷 (AUTO):** A simple “point-and-shoot” mode recommended for first-time users of digital cameras.

**M, A, S, P:** Select for full control over camera settings (📖 35), including aperture (**M** and **A**) and/or shutter speed (**M** and **S**).

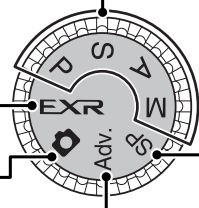

**SP (SCENE POSITION):** Choose a scene suited to the subject or shooting conditions and let the camera do the rest (📖 33).

**Adv. (ADVANCED):** Sophisticated techniques made easy (📖 25).



## **EXR (EXR AUTO/EXR Priority)**

Optimize settings for your current subject or improve clarity, reduce noise, or enhance dynamic range. Rotate the mode dial to **EXR** and choose one of the following **EXR** modes in the shooting menu.



### ■ **EXR AUTO (EXR AUTO)**

The camera automatically selects the scene and **EXR** mode according to shooting conditions (📖 17).

- ◆ If **AUTO** is selected for **IMAGE SIZE** in **EXR AUTO** mode, the camera will automatically select the optimal image size.
- ◆ **INTELLIGENT DIGITAL ZOOM** is restricted to 2× (📖 116).



Scene icon

### *The Scene Icon*

The camera selects from the following scenes:

Scene	LAND-SCAPE	NIGHT (TRIPOD)	MACRO	BEACH	SUNSET	SNOW	SKY	GREEN-ERY	SKY & GREENERY	
<b>Main subject</b>	<b>AUTO</b>	<b>SCAPE</b>	<b>NIGHT</b>	<b>MACRO</b>	<b>BEACH</b>	<b>SUNSET</b>	<b>SNOW</b>	<b>SKY</b>	<b>GREEN-ERY</b>	<b>SKY &amp; GREENERY</b>
Non-portrait	📷	🌄	🌃*	🔍*	🏖️	🌅	❄️	☁️	🌳	🌳
Portrait	Normal	👤👤	👤👤*	—	👤👤	👤👤	👤👤	👤👤	👤👤	👤👤
	Backlit	👤👤	—	—	👤👤	👤👤	👤👤	👤👤	👤👤	👤👤
Moving object	🏃	🏃	🏃	🏃	🏃	🏃	🏃	🏃	🏃	🏃
Portrait and motion	Normal	👤👤	👤👤	—	👤👤	👤👤	👤👤	👤👤	👤👤	👤👤
	Backlit	👤👤	—	—	👤👤	👤👤	👤👤	👤👤	👤👤	👤👤

\* If 📷 is displayed, the camera will take a series of shots (advanced anti-blur; 📖 24).

- ⓘ The mode selected may vary with shooting conditions. If the mode and subject do not match, select **📷** mode (📖 22) or choose **SP** (📖 33) and select a scene manually.



### **Advanced Anti Blur**

When  is displayed, the camera will take a series of exposures and combine them to form a single image, reducing “noise” (mottling) and blur.

- ◆  is available when **ON** is selected in the shooting menu (📖 93) and the flash (📖 41) is off or set to auto.
- ① Some time may be required to combine the exposures into a single image. A single combined image may not be created if the subject or camera moves during shooting. Keep the camera steady during shooting and do not move the camera until shooting is complete.
- ① Frame coverage is reduced.







### *The* **EXR** *Icon*

When the shutter button is pressed halfway, the camera chooses the preferred **EXR** mode:

-  (**RESOLUTION PRIORITY**): Produces crisp, clear shots.
-  (**HIGH ISO & LOW NOISE**): Reduces noise in pictures taken at high sensitivities.
-  (**D-RANGE PRIORITY**): Increases the amount of detail visible in highlights.

### ■ **EXR** Priority

Select this mode to manually choose from the following **EXR** modes:

-  (**RESOLUTION PRIORITY**): Choose for crisp, clear shots.
  -  (**HIGH ISO & LOW NOISE**): Reduce noise in pictures taken at high sensitivities.
  -  (**D-RANGE PRIORITY**): Increase the amount of detail visible in highlights.
-  **DYNAMIC RANGE** (📖 95) can be set to  (1600%) and  (800%).

**Adv. *ADVANCED***

This mode combines “point-and-shoot” simplicity with sophisticated photographic techniques. The  **Adv. MODE** option in the shooting menu can be used to choose from the following advanced modes:



** MOTION PANORAMA 360**

Follow an on-screen guide to take photos that will automatically be joined to form a panorama. The camera zooms all the way out and remains fixed at the widest angle until shooting is complete.



- 1** To select the angle through which you will pan the camera while shooting, press the selector down. Press the selector left or right to highlight an angle and press **MENU/OK**.
- 2** Press the selector right to view a choice of pan directions. Press the selector left or right to highlight a pan direction and press **MENU/OK**.
- 3** Press the shutter button all the way down to start recording. There is no need to keep the shutter button pressed during recording.

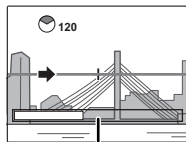

**4** Pan the camera in the direction shown by the arrow. Shooting ends automatically when the progress bar is full and the panorama is complete.







*Progress bar*

- ◆ Shooting ends if the shutter button is pressed all the way down during shooting. No panorama will be recorded if the shutter button is pressed before the camera has been panned through 120°.
- ❗ Panoramas are created from multiple frames. The camera may in some cases record an greater or lesser angle than selected or be unable to stitch the frames together perfectly. The last part of the panorama may not be recorded if shooting ends before the panorama is complete.
- ❗ Shooting may be interrupted if the camera is panned too quickly or too slowly. Panning the camera in a direction other than that shown cancels shooting.
- ❗ The desired results may not be achieved with moving subjects, subjects close to the camera, unvarying subjects such as the sky or a field of grass, subjects that are in constant motion, such as waves and waterfalls, or subjects that undergo marked changes in brightness. Panoramas may be blurred if the subject is poorly lit.



Choose  for seamless 360° panoramas that can be played back in a loop ( 62).

- ◆ The  **SAVE ORG IMAGE** option in the setup menu can be used to record a  panorama in addition to a seamless  panorama ( 117).
- ① Depending on the subject and shooting conditions, the camera may produce distorted results or a  panorama. The top and bottom of the area visible in the shooting display are cropped out and white strips may appear at the top and bottom of the display.



### For Best Results

For best results, move the camera in a small circle at a steady speed, keeping the camera horizontal and being careful only to pan in the direction shown by the guides. If the desired results are not achieved, try panning at a different speed.

### ■ PRO FOCUS

The camera takes up to three shots each time the shutter button is pressed, softening the background to emphasize the main subject. The amount of softening can be adjusted before shooting by pressing the selector left or right. Use for portraits or photos of flowers similar to those produced by SLR cameras.



- ◆ Softening can not be applied to background objects that are too close to the main subject. If a message stating that the camera can not create the effect is displayed when the camera focuses, try backing away from your subject and zooming in. The camera may also be unable to soften the background if the subject is moving; if prompted, check the results and try again.



## ■ PRO LOW-LIGHT

Each time the shutter button is pressed, the camera makes four exposures and combines them into a single photograph. Use to reduce noise and blur when photographing poorly lit subjects or static subjects at high zoom ratios.



- ◆ A single combined photograph may not be created with some scenes or if the subject or camera moves during shooting. Do not move the camera until shooting is complete.

### PRO FOCUS/PRO LOW-LIGHT

To save unprocessed copies of pictures taken in these modes, select **ON** for the  **SAVE ORG IMAGE** option in the setup menu ( 117).

- ① Keep the camera steady during shooting.
- ① Frame coverage is reduced.

## ■ MULTIPLE EXPOSURE

Create a photograph that combines two exposures.

**1** Take the first shot.

**2** Press **MENU/OK**. The first shot will be shown superimposed on the view through the lens as a guide to taking the second shot.

◆ To return to Step 1 and retake the first shot, press the selector left. To save the first shot and exit without creating a multiple exposure, press **DISP/BACK**.

**3** Take the second shot.

**4** Press **MENU/OK** to create the multiple exposure, or press the selector left to return to Step 3 and retake the second shot.



## ■ INDIVID. SHUTTER 3D

Take two shots from different angles to create a 3D image.

- 1 To choose the order in which the pictures are taken, press the selector right to display the current order and then press the selector left or right to choose from the options below.

: Take the left shot first.

: Take the right shot first.

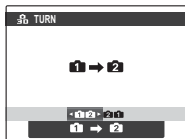

- 2 Press the shutter button to take the first shot.

❖ To exit without recording a picture, press **DISP/BACK**.

- 3 The first shot will be shown superimposed on the view through the lens. Using it as a guide, frame the second shot and press the shutter release button.

❖ The 3D effect may not be visible with some subjects or under some shooting conditions. For best results, the distance the camera is moved between shots should be about  $\frac{1}{30}$ th to  $\frac{1}{50}$ th of the distance to the subject.



❖ The camera will turn off automatically if no operations performed for the time selected for **OFF AUTO POWER OFF** (📖 114). The first shot will not be saved if the second shot is not taken before the camera turns off.

### Viewing and Printing 3D Images















- **The camera** displays images in 2D. Press the selector down to toggle between the first and second shots.
  - **Devices equipped for 3D display**, such as the FINEPIX REAL 3D V3 digital photo frame or FINEPIX REAL 3D W3 digital camera, will display the images in 3D.
  - **3D prints** can be ordered from <http://www.fujifilm.com/3d/print/>
  - **The supplied software** displays 3D anaglyph images. 3D photos can also be viewed using other applications that support the MP format.
  - **3D TVs** that support the MP format can display images in 3D. See the manual for your TV for details.
- ① Images are not output in 3D when printed directly from the camera.
- ① 3D images are displayed in 2D in slide shows and when output on a conventional TV.
- ① 3D images can not be edited or retouched.





**Note:** The MP (**M**ulti-**P**icture) format is a CIPA standard for files containing multiple still images. Files in MP format are referred to as “MP files” and have the extension “\*.MPO”. The camera uses this format for 3D images.

**SP SCENE POSITION**

The camera offers a choice of “scenes,” each adapted to particular shooting conditions or a specific type of subject. Use the  **SCENE POSITION** option in the shooting menu to choose the scene assigned to the **SP** position on the mode dial.



Scene	Description
 <b>NATURAL &amp; FLASH</b>	The camera takes two shots: one without the flash and one with.
 <b>NATURAL LIGHT</b>	Capture natural lighting under low-light conditions.
 <b>PORTRAIT</b>	Choose for portraits.
 <b>PORTRAIT ENHANCER</b>	Choose for a smooth skin effect when shooting portraits.
 <b>DOG</b>	Choose when photographing dogs.
 <b>CAT</b>	Choose when photographing cats.
 <b>LANDSCAPE</b>	Choose for daylight shots of buildings and landscapes.
 <b>SPORT</b>	Choose when photographing moving subjects.
 <b>NIGHT</b>	Choose this mode for poorly lit twilight or night scenes.
 <b>NIGHT (TRIPOD)</b>	Choose this mode for slow shutter speeds when shooting at night.
 <b>FIREWORKS</b>	Slow shutter speeds are used to capture the expanding burst of light from a firework.
 <b>SUNSET</b>	Choose this mode to record the vivid colors in sunrises and sunsets.
 <b>SNOW</b>	Choose for crisp, clear shots that capture the brightness of scenes dominated by shining white snow.
 <b>BEACH</b>	Choose for crisp, clear shots that capture the brightness of sunlit beaches.

Scene	Description
 <b>UNDERWATER</b>	Reduces the blue cast typically associated with underwater lighting.
 <b>PARTY</b>	Capture indoor background lighting under low-light conditions.
 <b>FLOWER</b>	Choose for vivid close-ups of flowers.
 <b>TEXT</b>	Take clear pictures of text or drawings in print.

### **DOG/CAT**

The camera focuses on the faces of dogs or cats that are facing the camera, and the self-timer menu offers a  **AUTO RELEASE** option that releases the shutter automatically when a pet is detected (📖 43). During playback, image search (📖 59) can be used to search for pictures taken in either mode.

❖ Although camera can detect many different breeds of dogs and cats, results may vary with the breed and shooting conditions. The camera may fail to detect pets with dark-colored faces or long hair covering their entire face. If a dog or cat is not detected, the camera focuses on the subject at the center of the frame.

**M MANUAL**

In this mode, you control both shutter speed and aperture.

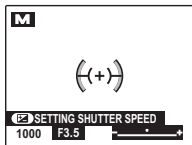

Press the selector up (⏏) to highlight shutter speed or aperture and use the command dial to adjust the highlighted item. If desired, exposure can be altered from the value selected by the camera.

**The Exposure Indicator**

The amount the picture will be under- or over-exposed at current settings is shown by the exposure indicator.

**A APERTURE PRIORITY AE**

You choose the aperture using the command dial, while the camera adjusts shutter speed for optimal exposure.



ⓘ If the correct exposure can not be achieved at the selected aperture, shutter speed will be displayed in red. Adjust aperture until the correct exposure is achieved. If the subject is outside the metering range of the camera, the shutter speed display will show "----". Press the shutter button halfway to measure exposure again.

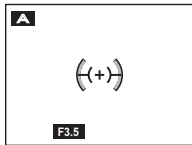

## **S SHUTTER PRIORITY AE**

You choose the shutter speed using the command dial, while the camera adjusts aperture for optimal exposure.



- ① If the correct exposure can not be achieved at the selected shutter speed, aperture will be displayed in red. Adjust shutter speed until the correct exposure is achieved. If the subject is outside the metering range of the camera, the aperture display will show "F---". Press the shutter button halfway to measure exposure again.

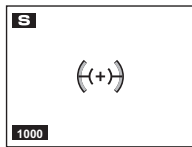

## **P PROGRAM AE**

The camera sets exposure automatically.



- ① If the subject is outside the metering range of the camera, the shutter speed and aperture displays will show "----". Press the shutter button halfway to measure exposure again.

## Focus Lock

To compose photographs with off-center subjects:

**1 Focus:** Position the subject in the focus frame ((+)) and press the shutter button halfway to lock focus and exposure. Focus and exposure will remain locked while the shutter button is pressed halfway (AF/AE lock).



**2 Recompose:** Keep the button pressed halfway.



**3 Shoot:** Press the button all the way down.



### Autofocus

Although the camera boasts a high-precision autofocus system, it may be unable to focus on the subjects listed below. If the camera is unable to focus, focus on another subject at the same distance and use focus lock to recompose the photograph.

- Very shiny subjects such as mirrors or car bodies.
- Fast-moving subjects.
- Subjects photographed through a window or other reflective object.
- Dark subjects and subjects that absorb rather than reflect light, such as hair or fur.
- Insubstantial subjects, such as smoke or flame.
- Subjects that show little contrast with the background (for example, subjects in clothing that is the same color as the background).
- Subjects positioned in front of or behind a high-contrast object that is also in the focus frame (for example, a subject photographed against a backdrop of highly contrasting elements).



## Exposure Compensation

To adjust exposure compensation when photographing very bright, very dark, or high-contrast subjects, press the selector up () . Press the selector up or down or use the command dial to choose an exposure compensation value and then press **MENU/OK**.

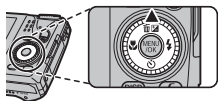



*Choose positive (+) values  
to increase exposure*



*Choose negative (-) values  
to reduce exposure*

- ◆ A  icon and exposure indicator are displayed at settings other than  $\pm 0$ . Exposure compensation is not reset when the camera is turned off; to restore normal exposure control, choose a value of  $\pm 0$ .
- ◆ Turn the flash off when using exposure compensation.

## Macro Mode (Close-ups)

For close-ups, press the selector left () and select . When macro mode is in effect, the camera focuses on subjects near the center of the frame. Use the zoom control to compose pictures ( 18).

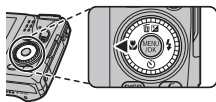

To exit macro mode, press the selector left () and select **OFF**.

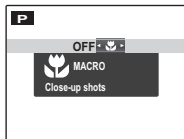

- ◆ Use of a tripod is recommended to prevent blur caused by camera shake.
- ◆ The shadow cast by the lens may appear in photographs taken with the flash at very short ranges. Zoom out or increase the distance to the subject.

## ⚡ Using the Flash (Super-Intelligent Flash)

When the flash is used, the camera's *Super-Intelligent Flash* system instantly analyzes the scene based on such factors as the brightness of the subject, its position in the frame, and its distance from the camera. Flash output and sensitivity are adjusted to ensure that the main subject is correctly exposed while preserving the effects of ambient background lighting, even in dimly-lit indoor scenes. Use the flash when lighting is poor, for example when shooting at night or indoors under low light.

1 Press the flash pop-up button to raise the flash.



2 Press the selector right (➡) and choose from the following flash modes:

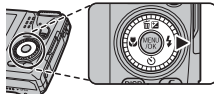



Option	Description
AUTO/AUTO*	The flash fires when required. Recommended in most situations.
⚡/👁️*	The flash fires whenever a picture is taken. Use for backlit subjects or for natural coloration when shooting in bright light.
S⚡/👁️*	Capture both the main subject and the background under low light (note that brightly lit scenes may be overexposed).

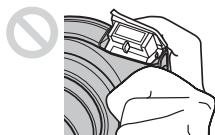

\* 👁️ icon indicates that Intelligent Face Detection and red-eye removal are on and will be used to minimize "red-eye" caused by the flash reflecting from the retinas of portrait subjects.

- ◆ Changing the angle of the flash turns the flash off.



- ◆ Lower the flash where flash photography is prohibited or to capture natural lighting under dim light. We also recommend that you lower the flash when the camera is off.
- ◆ If the flash will fire,  will be displayed when the shutter button is pressed halfway. At slow shutter speeds,  will appear in the display to warn that pictures may be blurred; use of a tripod is recommended.
- ◆ The flash may fire several times with each shot. Do not move the camera until shooting is complete.
- ◆ The flash may cause vignetting.

## ⏸ Using the Self-Timer

To use the self-timer, press the selector down (⏸) and choose from the following options:

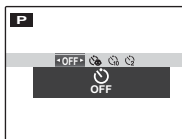
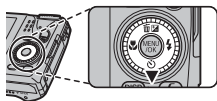

Option	Description
⏸ (OFF)	Self-timer off.
🐾 (AUTO RELEASE)	The shutter is released automatically when the camera detects the face of a cat or dog (📖 34).
👶 (AUTO RELEASE)	The shutter is released automatically when the camera detects a human portrait subject facing the camera. Use for portraits of babies.
⏸ (10 SEC)	The shutter is released ten seconds after the shutter button is pressed. Use for self-portraits. The self-timer lamp on the front of the camera lights when the timer starts and begins to blink shortly before the photo is taken.
⏸ (2 SEC)	The shutter is released two seconds after the shutter button is pressed. Use to reduce blur caused by the camera moving when the shutter button is pressed. The self-timer lamp will blink as the timer counts down.

## The Fn Button

The role played by the **Fn** button can be selected using the **Fn Fn BUTTON** option in the setup menu (📖 114).

The following options are available:

**ISO** (📖 90)/**IMAGE SIZE** (📖 91)/**IMAGE QUALITY** (📖 94)/  
**RAW** (F770EXR Only) (📖 117)/**DYNAMIC RANGE** (📖 95)/  
**FILM SIMULATION** (📖 93)/**PHOTOMETRY** (📖 98)/**AF MODE** (📖 99)/  
**FACE RECOGNITION** (📖 51)/**FACE DETECTION** (📖 45)/  
**LANDMARK NAVIGATOR** (F770EXR Only) (📖 71)

- ❖ The **Fn Fn BUTTON** menu can also be displayed by pressing and holding the **Fn** button.

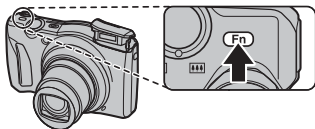

## Intelligent Face Detection

Intelligent Face Detection sets focus and exposure for human faces anywhere in the frame, preventing the camera from focusing on the background in group portraits. Choose for shots that emphasize portrait subjects.

To use Intelligent Face Detection, press **MENU/OK** to display the shooting menu and select **ON** for  **FACE DETECTION**. Faces can be detected with the camera in vertical or horizontal orientation; if a face is detected, it will be indicated by a green border. If there is more than one face in the frame, the camera will select the face closest to the center; other faces are indicated by white borders.

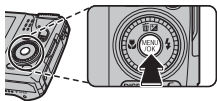





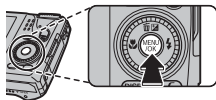

- ❗ In some modes, the camera may set exposure for the frame as a whole rather than the portrait subject.
- ❗ If the subject moves as the shutter button is pressed, their face may not be in the area indicated by the green border when the picture is taken.

## Continuous Shooting

To capture motion in a series of pictures, press **MENU/OK**, select  **CONTINUOUS** in the shooting menu (📖 97), and choose from the options listed in this section.



Option	F770EXR	F750EXR
 <b>AE BKT</b>		(📖 50)
 <b>FILM SIMULATION BKT</b>		(📖 50)
 <b>DYNAMIC RANGE BKT</b>		(📖 50)
 <b>TOP <i>n</i></b>	(📖 47)	(📖 47)
 <b>BEST FRAME CAPTURE</b>	(📖 48)	—
 <b>FINAL <i>n</i></b>	—	(📖 48)
<b>OFF</b>	—	—

- ❖ The flash turns off automatically. The previously selected flash mode is restored when **OFF** is selected for  **CONTINUOUS**.
- ❖ Frame rate varies with shutter speed.
- ❖ Focus and exposure are determined by the first frame in each series.
- ❖ The number of pictures that can be taken in a single burst varies with the scene and camera settings. The number of pictures that can be recorded depends on the memory available.



### ■ TOP n (F770EXR)

The camera takes photographs while the shutter button is pressed. To choose the frame rate:

- 1 Press the selector right when the camera is in shooting mode.
- 2 Press the selector up or down to choose a frame rate and press **MENU/OK** to select and return to shooting mode.

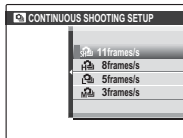

### ■ TOP n (F750EXR)

The camera takes photographs while the shutter button is pressed. To choose the frame rate and maximum number of shots per burst:

- 1 Press the selector right when the camera is in shooting mode.
- 2 Highlight the current frame rate or number of shots and press the selector right, then press selector up or down to choose a new value and press **MENU/OK** to select.
- 3 Press **DISP/BACK** to return to shooting mode when settings are complete.

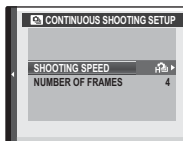

### FINAL *n* (F750EXR Only)

The camera takes up to 40 pictures, but only the last shots are recorded. The number of shots recorded can be selected by pressing the selector right while the camera is in shooting mode.

Only one photo is taken if the self-timer is used.

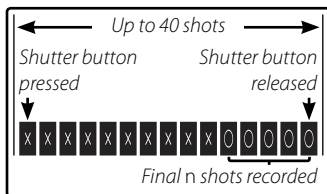

### BEST FRAME CAPTURE (F770EXR Only)

The camera takes a series of pictures, starting before and ending after the shutter button is pressed.

- 1 Press the selector right when the camera is in shooting mode.
- 2 Highlight the current frame rate and press the selector right, then press selector up or down to choose a new value and press **MENU/OK** to select.

Some frame rates may reduce the number of shots available.

- 3 Highlight the number of shots and press the selector right. Press the selector up or down to choose the number of shots in each burst and left or right to choose their distribution (the number on the left is taken *before* and the number on the right *after* the shutter button is pressed). Press **MENU/OK** when settings are complete and press **DISP/BACK** to return to shooting mode.

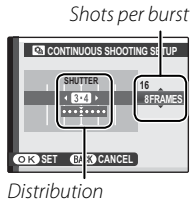

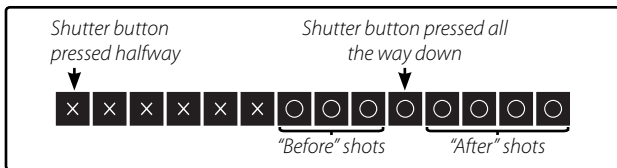

- 4 Take photographs. The camera begins recording while the shutter button is pressed halfway, and completes the burst when the shutter button is pressed all the way down. The illustration shows a burst of eight shots, three before the shutter button is pressed and four after.







- ① If the shutter button is pressed all the way down before the number of frames selected for the "before" portion is recorded, the remaining frames will be taken after the shutter button is pressed all the way down.
- ① If the shutter button is pressed halfway for an extended period, the camera may record the burst before the shutter button is pressed all the way down.









## ■ AE BKT

Each time the shutter button is pressed, the camera takes three shots: one using the metered value for exposure, the second overexposed by the amount selected for  **AE BKT EV STEPS** in the shooting menu ( 100), and the third underexposed by the same amount (the camera may not be able to use the selected bracketing increment if the amount of over- or under- exposure exceeds the limits of the exposure metering system).

## ■ FILM SIMULATION BKT

Each time the shutter button is pressed, the camera takes one shot and processes it to create three copies with different  **FILM SIMULATION** settings ( 93):  **PROVIA/STANDARD** for the first,  **Velvia/VIVID** for the second, and  **ASTIA/SOFT** for the third.

## ■ DYNAMIC RANGE BKT

Each time the shutter button is pressed, the camera takes three shots at different  **DYNAMIC RANGE** settings ( 95):  **100%** for the first,  **200%** for the second, and  **400%** for the third ( **ISO** can not exceed 3200; values less than 400 are not available when  is selected for  **IMAGE SIZE**).

## Face Recognition

The camera can store information on the face and personal details (name, relationship, and birth date) of portrait subjects and assign these subjects priority for Intelligent Face Detection or display their names and other information during playback.



### **Adding New Faces**

Follow the steps below to add faces to the face recognition database.

#### **1 Select REGISTER.**

Select **REGISTER** for  **FACE RECOGNITION** in the shooting menu.

◆ To disable face recognition, select **OFF**.

#### **2 Take a photograph.**

After checking that the subject is facing the camera, frame the subject using the guides and take the photograph.

◆ If an error is displayed, take the photograph again.



### 3 Enter face recognition data

Press **MENU/OK** to display face recognition data and enter the following information:

- **NAME:** Enter a name of up to 14 characters and press **MENU/OK**.
  - **BIRTHDAY:** Enter the subject's date of birth and press **MENU/OK**.
  - **CATEGORY:** Choose the option that describes your relationship to the subject and press **MENU/OK**.
- ◆ If you attempt to zoom in on the face of a person indicated by a green border in the face recognition database on their birthday, the camera will display their name and the message "Happy Birthday!"

### ***Viewing, Editing, and Deleting Existing Data***

Follow the steps below to view, edit, or delete face recognition data.

**1** Select **VIEW & EDIT** for  **FACE RECOGNITION**.

**2** Select a face.

**3** View or edit face recognition data.

The name, category, or birth date can be edited as described in Step 3 of “Adding New Faces” (📖 52). To retake the photo, select **REPLACING IMAGE** and shoot a new portrait as described above.

◆ To delete face recognition data for the selected subject, select **ERASE**.

### ***Adding Faces Automatically***

To automatically add frequently-photographed subjects to the face recognition database, select **ON** for **AUTO REGISTRATION** in the face recognition menu. If the camera detects a face that has been photographed many times without being added to the database, it will display a message prompting you to create a new face recognition entry. Press **MENU/OK** and enter face recognition data.

◆ The camera may sometimes fail to recognize new faces automatically. If necessary, faces can be added manually using the **REGISTER** option.

## Face Recognition

The camera can store up to eight faces. If you attempt to add a ninth face, a confirmation dialog will be displayed; use **VIEW & EDIT** to make room for new faces by deleting existing data. **AUTO REGISTRATION** is disabled if there are already data for eight faces.

When Intelligent Face Detection ( 45) is on and the frame contains multiple subjects from the face recognition database, the camera displays the name of the subject that will be used to set focus and exposure (the subject shown by the green frame). If no name is entered, the camera will show “----”. Subjects identified using face recognition but not used to set focus and exposure are shown by orange frames, other subjects by white frames.

① The camera may fail to identify subjects in the face recognition database if they are not facing the camera or are only partly in the frame, or if details of the subjects' faces or expressions differ markedly from those in the database.



## More on Playback

### Playback Options

To view the most recent picture in the LCD monitor, press the  button.

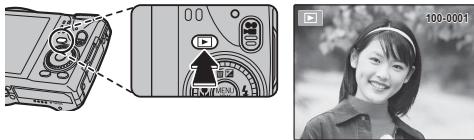

Press the selector right to view pictures in the order recorded, left to view pictures in reverse order. Keep the selector pressed to scroll rapidly to the desired frame.

◆ Pictures taken using other cameras are indicated by a  ("gift image") icon during playback.

### Continuous Shooting

In the case of pictures taken in continuous shooting mode, only the first frame of each series will be displayed. Press the selector down to view the other pictures in the series.

### ★ Favorites: Rating Pictures

To rate the picture currently displayed in full-frame playback, press **DISP/BACK** and press the selector up and down to select from zero to five stars.

## **Playback Zoom**

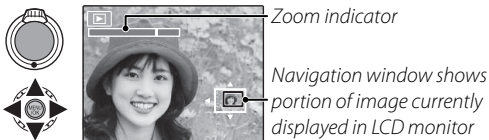

Select **[Z]** to zoom in on pictures displayed in single-frame playback; select **[Z]** to zoom out. When the picture is zoomed in, the selector can be used to view areas of the image not currently visible in the display.



Press **DISP/BACK** to exit zoom.

- ◆ Rotate the command dial to view other pictures without changing the zoom ratio.
- ◆ The maximum zoom ratio varies with image size. Playback zoom is not available with cropped or resized copies saved at a size of **640** or smaller.

## ***Multi-Frame Playback***

Selecting  when a picture is shown full-frame in the LCD monitor displays the current image with previous and following images in the background. Select  to increase the number of images displayed to two, nine, or one hundred,  to view fewer images.

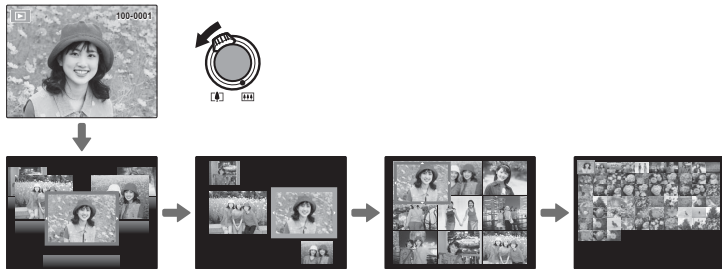

When two or more images are displayed, use the selector to highlight images and press **MENU/OK** to view the highlighted image full frame. In the nine- and hundred-frame displays, use the selector to view more pictures.

## Deleting Pictures

To delete individual pictures, multiple selected pictures, or all pictures, press **MENU/OK**, select  **ERASE** (📖 103), and choose from the options below. *Note that deleted pictures can not be recovered. Copy important pictures to a computer or other storage device before proceeding.*

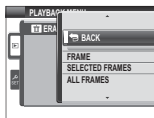









Option	Description
<b>FRAME</b>	Press the selector left or right to scroll through pictures and press <b>MENU/OK</b> to delete the current picture (a confirmation dialog is not displayed).
<b>SELECTED FRAMES</b>	Highlight pictures and press <b>MENU/OK</b> to select or deselect (pictures in photobooks or print orders are shown by  ). When the operation is complete, press <b>DISP/BACK</b> to display a confirmation dialog, then highlight <b>OK</b> and press <b>MENU/OK</b> to delete the selected pictures.
<b>ALL FRAMES</b>	A confirmation dialog will be displayed; highlight <b>OK</b> and press <b>MENU/OK</b> to delete all unprotected pictures (if a memory card is inserted, only the pictures on the memory card will be affected; the pictures in internal memory are only deleted if no memory card is inserted). Pressing <b>DISP/BACK</b> cancels deletion; note that any pictures deleted before the button was pressed can not be recovered.

- ◆ Protected pictures can not be deleted. Remove protection from any pictures you wish to delete (📖 105).
- ◆ If a message appears stating that the selected images are part of a DPOF print order, press **MENU/OK** to delete the pictures.

## Image Search

Search for pictures.

- 1 Select  **IMAGE SEARCH** in the playback menu ( 103), highlight one of the following search criteria, and press **MENU/OK**:
  - **BY DATE**: Search by date.
  - **BY GPS LOCATION NAME** (F770EXR Only): Search by location name (location names that do not begin with a letter from A to Z are listed in the search conditions under “#”).
  - **BY FACE**: Search for faces from the face recognition database.
  - **BY ★ FAVORITES**: Search by rating.
  - **BY SCENE**: Search by scene.
  - **BY TYPE OF DATA**: Find all still pictures or all movies.
  - **BY UPLOAD MARK**: Find all pictures selected for upload to a specified destination.
- 2 Select a search condition. Only pictures that match the search condition will be displayed. To delete or protect selected pictures or to view the search results in a slide show, press **MENU/OK** and choose  **ERASE** ( 103),  **PROTECT** ( 105), or  **SLIDE SHOW** ( 102).

## PhotoBook Assist

---

Create books from your favorite photos.

### ***Creating a PhotoBook***

**1** Select **NEW BOOK** for  **PHOTOBOOK ASSIST** in the playback menu ( 101) and choose from the following options:

- **SELECT FROM ALL:** Choose from all available pictures.
- **SELECT BY IMAGE SEARCH:** Choose from pictures matching selected search conditions ( 59).

◆ Movies, 3D photos, and photographs  640 or smaller can not be selected for photobooks.

**2** Scroll through the images and press the selector up to select or deselect. To display the current image on the cover, press the selector down. Press **MENU/OK** to exit when the book is complete.

◆ The first picture selected becomes the cover image. Press the selector down to select a different image for the cover.

**3** Select **COMPLETE PHOTOBOOK** (to select all photos or all photos matching the specified search conditions for the book, choose **SELECT ALL**). The new book will be added to the list in the photobook assist menu.

ⓘ Books can contain up to 300 pictures.

ⓘ Books that contain no photos are automatically deleted.

### **Viewing Photobooks**

Highlight a book in the photobook assist menu and press **MENU/OK** to display the book, then press the selector left or right to scroll through the pictures.

### **Editing and Deleting Photobooks**

Display the photobook and press **MENU/OK**. The following options will be displayed; select the desired option and follow the on-screen instructions.

- **EDIT:** Edit the book as described in “Creating a PhotoBook” (📖 60).
- **ERASE:** Delete the book.

#### **Photobooks**

Photobooks can be copied to a computer using the supplied MyFinePix Studio software.

## Viewing Panoramas

If you press the selector down when a panorama is displayed full frame, the camera will play back the picture from left to right or from bottom to top. To pause playback, press the selector down; press the selector down again to resume. To exit to full-frame playback, press the selector up while panorama playback is in progress. Once displayed in full-frame playback, panoramas can be zoomed in or out using the zoom control or deleted by pressing the selector up (🗑️).

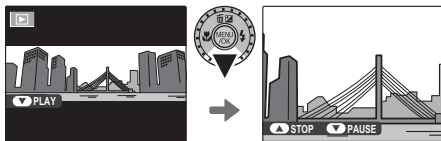

- ▶️ 📺 panoramas play back in an endless loop (📖 27); the playback direction can be controlled by pressing the selector left or right. The camera will not turn off automatically while playback is in progress (📖 114).



## Viewing Photo Information

Photo information can be viewed by pressing **DISP/BACK** to cycle through indicators (📖 6) until the following display appears:

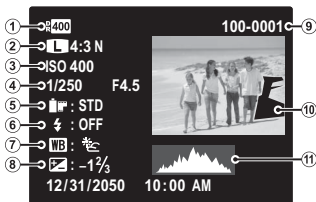

- ① Dynamic range
- ② Image size and quality
- ③ Sensitivity
- ④ Shutter speed/aperture
- ⑤ Film simulation
- ⑥ Flash mode
- ⑦ White balance
- ⑧ Exposure compensation
- ⑨ Frame number
- ⑩ Picture (overexposed areas blink on and off)
- ⑪ Histogram

### Histograms

Histograms show the distribution of tones in the image. Brightness is shown by the horizontal axis, the number of pixels by the vertical axis.

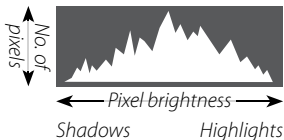

**Optimal exposure:** Pixels are distributed in an even curve throughout the tone range.

**Overexposed:** Pixels are clustered on the right side of the graph.

**Underexposed:** Pixels are clustered on the left side of the graph.

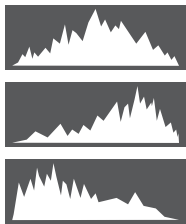

 **Zooming in on the Focus Point**

Press the selector down to zoom in on the focus point. Press **DISP/BACK** or **MENU/OK** to return to full-frame playback.





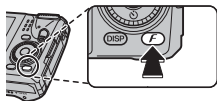

## GPS (F770EXR Only)

### Recording GPS Data with Pictures

To record GPS data with new pictures, press the **F** button and select one of the following options for **GPS SETUP > LOCATION SEARCH** in the **F**-mode menu (📖 92).



- **PERMANENTLY ON:** The camera continues to update GPS data for up to 3 hours after being turned off. The camera will be quicker to display GPS data when turned on, but the drain on the battery will increase. Note that GPS data is not updated at battery levels of  or below.
  - **WHEN SWITCHED ON:** The camera updates GPS data only when on. The camera may need some time to acquire GPS data when turned on. This option is selected automatically at battery levels of  and below.
- ❖ GPS works best outdoors under clear skies.

During shooting, GPS data are displayed in the monitor as shown at right. Signal strength is indicated by the number of bars;  is displayed when the camera is searching for a signal,  if the camera is in GPS demo mode, and  if no signal is detected. The most current location is shown by a place name or (if no place name is available) by the longitude and latitude.

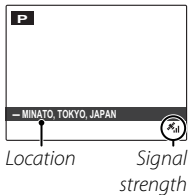

- ❖ **LOCATION INFO** (📖 92) can be used to choose whether the camera shows place names or latitude and longitude. Choose **OFF** to hide GPS information.

- ① Using GPS increases the drain on the battery, causing battery performance to drop at low temperatures.
- ① The receiver may have an error of a few hundred meters (yards).
- ① The camera may be unable to receive GPS data in some locations. If possible, choose an outdoor location with few obstructions when turning the camera on.
- ① The position recorded when a photo is taken may differ from the actual location if some time has passed since the camera was last able to update GPS data.
- ① Select **OFF** for **LOCATION SEARCH** (📖 92) and **TRACKING DATA** (📖 92) in the **GPS SET-UP** menu when in a hospital and before takeoff and landing if traveling by air.
- ① Place names are current as of the date on which the map database was created (📖 139) and will not be updated to reflect any changes after that date.
- ① Place name data are unavailable in some countries and regions. If no name is available, the latitude and longitude will be displayed for a few seconds.

### GPS

The camera may be unable to receive GPS data if the antenna (📖 2) is obstructed or when underground, underwater, under a bridge or overpass, inside a vehicle, building, tunnel, or metal briefcase, between tall buildings, or in the vicinity of cell phones or other devices that broadcast in the 1.5 GHz band.

Obey all local regulations regarding the use of GPS devices. Note that the use of GPS devices is restricted in some countries, including the People's Republic of China. Before going abroad, consult with the embassy or a travel agent. The camera may display  (no signal) in locations in which restrictions apply.





## GPS Tracking

To record a GPS track log to a file on the memory card, select **ON** for **GPS SET-UP > TRACKING DATA** (📖 92; be sure the clock is set to the correct time and date as described on page 16). A new log file is created when **ON** is selected and once every 24 hours thereafter. Note that the camera will continue to update GPS data even when off, increasing the drain on the battery.

- ⓘ GPS logs can be viewed in MyFinePix Studio.
- ⓘ See “GPS” (📖 66) for information on using GPS.
- ⓘ The indicator lamp glows orange during recording GPS data even when the camera is turned off while **ON** is selected. Select **OFF** before removing the battery or memory card. Failure to observe this precaution could damage the card.
- ⓘ Tracking ends after the camera has been off for 3 hours consecutively.
- ⓘ Signal strength will be displayed in yellow and GPS data will not be logged if the battery is low (🔋 or less), no memory card is inserted, or the memory card has less than 32 MB free. To resume the log, select **ON** after inserting a charged battery or a memory card with more than 32 MB free.
- ⓘ GPS tracking may be interrupted during movie recording and playback.

### Using GPS to Set the Camera Clock

The **AUTO TIME CORRECTION** item in the  **SET-UP** menu can be used to synchronize the camera clock to the time provided by GPS satellites. Select **ON (W/o SUMMERTIME)** to set the clock to local standard time or **ON (W/ SUMMERTIME)** to set the clock to local daylight saving time. If daylight saving time is in effect, time will automatically be advanced one hour.

- ① If the camera is able to receive GPS data, the clock will be synchronized when the camera is turned off.
- ① Selecting  **LOCAL** for  **TIME DIFFERENCE** turns **AUTO TIME CORRECTION** off. Note that GPS may not provide the correct time in some locations; if necessary select **OFF** for **AUTO TIME CORRECTION** and set the clock using  **DATE/TIME** ( 111).

## Viewing GPS Data

During playback, pictures for which GPS data exist are indicated by a **GPS** icon. GPS data are shown for a few seconds each time the picture is displayed.

GPS icon



### Photo Navigation

To show the direction and distance from your present position to the location where a picture was taken:

- 1 Select an option other than **OFF** for **GPS SET-UP > LOCATION SEARCH** and confirm that the camera is receiving GPS data (📖 102).
- 2 Display a picture with a **GPS** icon.
- 3 Select **GPS PHOTO NAVIGATION** in the playback menu (📖 101). The approximate direction and distance to the location where the picture was taken are displayed as shown, using the units selected for **GPS SET-UP > km/mile** (📖 102). Distances over 1000 units are indicated by ">", those under 100 units by "<".

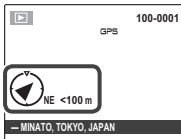

📌 Photo navigation ends when the next picture is displayed.

### **Copying GPS Data to Other Images**

GPS data can be copied from other pictures to images that lack correct GPS information.

- 1** Select **GPS LOCATION INFO COPY** in the playback menu (📖 103).
  - 2** Press the selector left or right to display the source image for the GPS data and press **MENU/OK**.
  - 3** Press the selector left or right to display the destination and press **MENU/OK** to copy the data to the image.
- ① GPS data can not be deleted. When GPS data are copied, however, the original GPS data for the destination image is replaced by the data for the source image; the original data for the destination image, if any, can not be recovered.
  - ① The camera may be unable to copy GPS data to or from images created on other devices.



## GPS Landmark Navigator

Landmark navigation uses GPS and the camera map database to show information on objects the display (this is sometimes known as “augmented reality,” or **AR**). To view landmark information, select **GPS LANDMARK NAVIGATOR** in the **F**-mode menu (📖 101, 90).

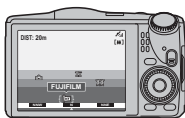

The display varies with camera orientation:

- For an “AR” display, hold the camera with the lens pointed forward.
- For a “radar” display, hold the camera with the lens pointed down.

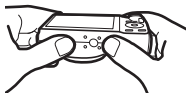
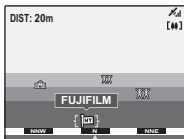

- ◆ Use the zoom control to zoom in and out. To display additional information, press the selector left or right to highlight landmarks and press **MENU/OK**. Press the selector down to choose the landmark type. Press **DISP/BACK** to return to playback or press the shutter button halfway to exit to shooting mode.
- ◆ Landmarks can be added using **GPS MY LANDMARK REGISTER** (📖 97).

- ⓘ Landmark information is based on the most recently-received GPS data; it is intended as a guide only and may be unavailable or contain errors under some conditions, including when the camera is held upside down. Headings rely on a magnetic compass and may not be correct if the camera is inside a building or vehicle or close to metal objects, magnets, high-voltage power lines, or electrical equipment.

### Calibration

A  icon indicates that the camera's internal sensor requires calibration. Move the camera slowly in a large figure eight while rotating your wrist as shown.

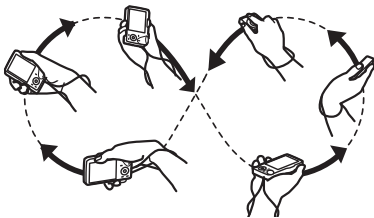

If the icon does not clear from the display, choose a different location and try again.

- ⓘ To ensure that you do not drop the camera, use the strap (📄 1).

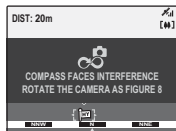

# Movies

## Recording Movies

Press  to shoot a movie. During recording, the following indicators will be displayed and sound will be recorded via the built-in microphone (be careful not to cover the microphone during recording).

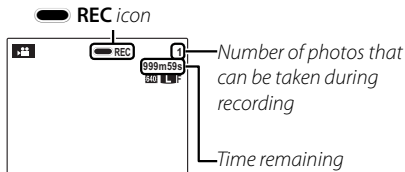

To end recording, press the  button again. Recording ends automatically when the movie reaches maximum length or memory is full.

- ❖ Zoom can be adjusted while recording is in progress.
- ❖ If the subject is poorly lit, the AF-assist lamp may light to assist the focus operation. To turn the AF-assist lamp off, select **OFF** for  **AF ILLUMINATOR** in the setup menu (📖 117).
- ❖ Focus, exposure, and white balance are adjusted automatically throughout recording. The color and brightness of the image may vary from that displayed before recording begins.
- ❖ Sounds made by the camera may be recorded.







### Taking Photographs During Recording

Press the shutter button to take a photograph during recording.

- ◆ See page 100 for information on choosing how photographs are recorded.
  - ◆ The photo is saved separately from the movie and does not appear as part of the movie.
  - ① Photos can not be taken while a high-speed movie is being recorded.
  - ① The number of photos that can be taken is limited.
- ① The indicator lamp lights while movies are being recorded. Do not open the battery chamber during shooting or while the indicator lamp is lit. Failure to observe this precaution could prevent the movie from being played back.
  - ① Vertical or horizontal streaks may appear in movies containing very bright subjects. This is normal and does not indicate a malfunction.
  - ① The temperature of the camera may rise if it is used to record movies for an extended period or if the ambient temperature is high. This is normal and does not indicate a malfunction.

### Movie Frame Size

Before recording, select a frame size using the  **MOVIE MODE** option in the shooting menu ( 100).

Option	Description
 <b>1920</b> (1920×1080)	Full HD (High Definition).
 <b>1280</b> (1280×720)	High Definition.
 <b>640</b> (640×480)	Standard definition.
 <b>640×480</b> (80 fps)	High speed movie. Sound is not recorded, and focus, exposure, and white balance are not adjusted automatically. Black bands appear at the top and
 <b>320×240</b> (160 fps)	bottom of movies recorded at  <b>320×112</b> .
 <b>320×112</b> (320 fps)	

## Viewing Movies

During playback, movies are displayed in the LCD monitor as shown at right. The following operations can be performed while a movie is displayed:

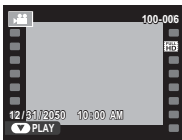

Option	Description
Start/pause playback	<b>Press the selector down</b> to start playback. Press again to pause. While playback is paused, you can press the selector left or right to rewind or advance one frame at a time.
End playback/delete	<b>Press the selector up</b> to end playback.
Adjust speed	<b>Press the selector left or right</b> to adjust playback speed during playback.
Adjust volume	<b>Press MENU/OK</b> to pause playback and display volume controls. Press the selector up or down to adjust the volume and press <b>MENU/OK</b> to exit. Volume can also be adjusted from the setup menu.

### Playback Speed

**Press the selector left or right** to adjust playback speed. Speed is shown by the number of arrows (▶ or ◀).

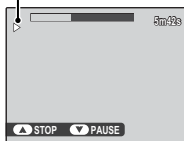

ⓘ Do not cover the speaker during playback.

## Connections

### Viewing Pictures on TV

Connect the camera to a TV to show pictures to a group.

- 1 Turn the camera off.
- 2 Connect the supplied A/V cable as shown below.

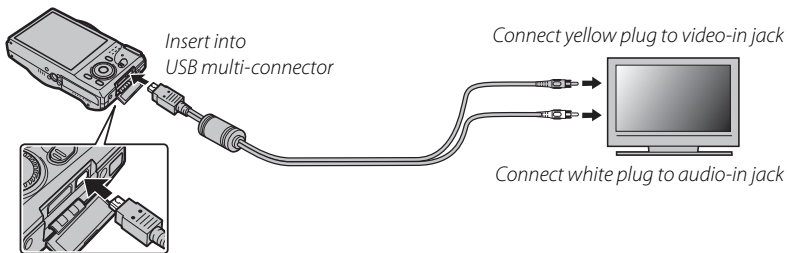

- ◆ Image quality drops during movie playback.

### Connecting the Camera to High Definition (HD) TVs

An HDMI cable (available from third-party suppliers) can be used to connect the camera to High Definition (HD) devices (playback only). The USB and A/V cables can not be used while an HDMI cable is connected.

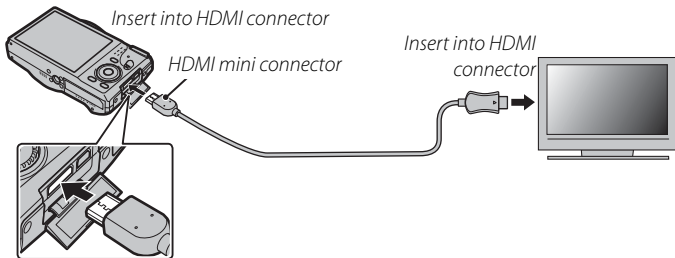

◆ When an HDMI cable is connected, pictures and sound are played back on the TV.

- ① When connecting cables, be sure the connectors are fully inserted.
- 3 Tune the television to the video or HDMI input channel. See the documentation supplied with the television for details.
- 4 Press the  button for about a second to turn the camera on. The camera monitor turns off and pictures and movies are played back on the TV. Note that the camera volume controls have no effect on sounds played on the TV; use the television volume controls to adjust the volume.

## Printing Pictures via USB

If the printer supports PictBridge, the camera can be connected directly to the printer as shown below and pictures can be printed without first being copied to a computer. Note that depending on the printer, not all the functions described below may be supported.



- 1 Connect the supplied USB cable as shown and turn the printer on.

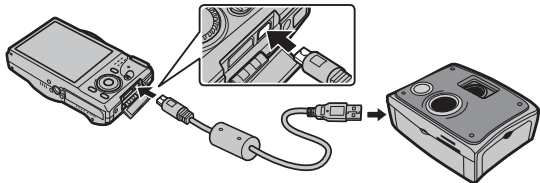

- 2 Turn the camera on.
- 3 Press the selector left or right to display a picture you wish to print.
- 4 Press the selector up or down to choose the number of copies (up to 99).
- 5 Repeat steps 3–4 to select additional pictures. Press **MENU/OK** to display a confirmation dialog when settings are complete.



- 6 Press **MENU/OK** to start printing. Printing can be interrupted by pressing **DISP/BACK**, but note that some printers may not respond immediately. If the printer stops before printing is complete, turn the camera off and then on again.
  - 7 After confirming that **PRINTING** has cleared from the camera display, turn the camera off and disconnect the USB cable.
- ❖ Pictures can be printed from internal memory or a memory card that has been formatted in the camera.
  - ❖ If no pictures are selected, the camera will print one copy of the current picture.
  - ❖ Page size, print quality, and border selections are made using the printer.

#### **Printing the Date of Recording**

To print the date of recording on pictures, press **DISP/BACK** in the PictBridge display and select **PRINT WITH DATE**  in the PictBridge menu (to print pictures without the date of recording, select **PRINT WITHOUT DATE**). Some printers do not support date printing. See the printer manual for details.

### **Printing the DPOF Print Order**

The  **PRINT ORDER (DPOF)** option in the playback menu can be used to create a digital “print order” for PictBridge-compatible printers (📖 120) or devices that support DPOF.

#### **DPOF**

DPOF (Digital Print Order Format) is a standard that allows pictures to be printed from “print orders” stored in internal memory or on a memory card. The information in the order includes the pictures to be printed and the number of copies of each picture.



- 1** Select playback mode and press **MENU/OK** to display the playback menu.
- 2** Highlight  **PRINT ORDER (DPOF)** and press **MENU/OK**.
- 3** Highlight one of the following options and press **MENU/OK**:
  - **WITH DATE** : Print the date of recording on pictures.
  - **WITHOUT DATE**: Do not print the date of recording on pictures.

◆ Some printers do not support date printing. See the printer manual for details.
- 4** Press the selector left or right to display a picture you wish to add to or remove from the print order.

- 5 Press the selector up or down to choose the number of copies (up to 99). To remove a picture from the print order, press the selector down until the number of copies is zero.
- 6 Repeat Steps 4–5 to complete the print order and press **MENU/OK** when settings are complete.
- 7 A confirmation dialog will be displayed. Press **MENU/OK** to save the print order.
  - ◆ Remove the memory card to create or modify a print order for the pictures in internal memory.
  - ◆ Print orders can contain a maximum of 999 pictures.
  - ◆ If a memory card is inserted containing a print order created by another camera, a message will be displayed. Create a new print order as described above.

## Viewing Pictures on a Computer

The supplied software can be used to copy pictures to a computer, where they can be stored, viewed, organized, and printed. Before proceeding, install the software as described below. **Do not connect the camera to the computer until installation is complete.**

### ***Windows: Installing MyFinePix Studio***

**1** Confirm that the computer meets the following system requirements:

	<b>Windows 7 (SP 1)/Windows Vista (SP 2)<sup>1</sup></b>	<b>Windows XP (SP 3)<sup>1</sup></b>
<b>CPU</b>	3 GHz Pentium 4 or better (2.4 GHz Core 2 Duo or better) <sup>2</sup>	2 GHz Pentium 4 or better (2.4 GHz Core 2 Duo or better) <sup>2</sup>
<b>RAM</b>	1 GB or more	512 MB or more (1 GB or more) <sup>2</sup>
<b>Free disk space</b>	2 GB or more	
<b>GPU</b>	Supports DirectX 9 or later (recommended)	Supports DirectX 7 or later (required; performance not guaranteed with other GPUs)
<b>Video</b>	1,024 × 768 pixels or more with 24-bit color or better	
<b>Other</b>	<ul style="list-style-type: none"><li>• Built-in USB port recommended. Operation is not guaranteed with other USB ports.</li><li>• .NET Framework 3.5 Service Pack 1 required when uploading images or using Map Viewer.</li><li>• Internet connection (broadband recommended) required to install .NET Framework (if necessary), to use auto update feature, and when performing such tasks as sharing pictures on-line or via e-mail.</li></ul>	

**1** Other versions of Windows are not supported. Only pre-installed operating systems are supported; operation is not guaranteed on home-built computers or computers that have been upgraded from earlier versions of Windows.

**2** Recommended when displaying HD movies.

- 2 Start the computer. Log in to an account with administrator privileges before proceeding.
- 3 Exit any applications that may be running and insert the installer CD in a CD-ROM drive.

 **Windows 7/Windows Vista**

If an AutoPlay dialog is displayed, click **SETUP.EXE**. A “User Account Control” dialog will then be displayed; click **Yes** (Windows 7) or **Allow** (Windows Vista).

The installer will start automatically; click **Install MyFinePix Studio** and follow the on-screen instructions to install MyFinePix Studio and RAW FILE CONVERTER (F770EXR only).

 **If the Installer Does Not Start Automatically**

If the installer does not start automatically, select **Computer** or **My Computer** from the Start menu, then double-click the **FINEPIX** CD icon to open the FINEPIX CD window and double-click **setup** or **SETUP.EXE**.

- 4** If prompted to install Windows Media Player or DirectX, follow the on-screen instructions to complete installation.
- 5** Remove the installer CD from the CD-ROM drive when installation is complete. Store the installer CD in a dry location out of direct sunlight in case you need to re-install the software.

Installation is now complete. Proceed to “Connecting the Camera” (📖 87).

***Macintosh: Installing FinePixViewer***

- 1 Confirm that the computer meets the following system requirements:

<b>CPU</b>	PowerPC or Intel (Core 2 Duo or better)*
<b>OS</b>	Pre-installed copies of Mac OS X version 10.3.9–10.6 (visit <a href="http://www.fujifilm.com/support/digital_cameras/compatibility/">http://www.fujifilm.com/support/digital_cameras/compatibility/</a> for more information). Mac OS X version 10.7 and later not supported.
<b>RAM</b>	256 MB or more (1 GB or more)*
<b>Free disk space</b>	A minimum of 200 MB required for installation with 400 MB available when FinePixViewer is running
<b>Video</b>	800 × 600 pixels or more with thousands of colors or better
<b>Other</b>	Built-in USB port recommended. Operation is not guaranteed with other USB ports.

\* Recommended when displaying HD movies.

- 2 After starting the computer and quitting any applications that may be running, insert the installer CD in a CD-ROM drive and double-click **Installer for Mac OS X**.

◆ To install RAW FILE CONVERTER, double-click **SILKYRFCEXInstaller**. RAW FILE CONVERTER is used to view RAW images on your computer (F770EXR only).

- 3 An installer dialog will be displayed; click **Installing FinePixViewer** to start installation. Enter an administrator name and password when prompted and click **OK**, then follow the on-screen instructions to install FinePixViewer. Click **Exit** to quit the installer when installation is complete.

**4** Remove the installer CD from the CD-ROM drive. Note that you may be unable to remove the CD if Safari is running; if necessary, quit Safari before removing the CD. Store the installer CD in a dry location out of direct sunlight in case you need to re-install the software.

**5 Mac OS X 10.5 or earlier:** Open the “Applications” folder, start Image Capture, and select **Preferences...** from the Image Capture application menu. The Image Capture preferences dialog will be displayed; choose **Other...** in the **When a camera is connected, open** menu, then select **FPVBridge** in the “Applications/FinePixViewer” folder and click **Open**. Quit Image Capture.

**Mac OS X 10.6:** Connect the camera and turn it on. Open the “Applications” folder and start Image Capture. The camera will be listed under **DEVICES**; select the camera and choose **FPVBridge** from the **Connecting this camera opens** menu and click **Choose**. Quit Image Capture.

Installation is now complete. Proceed to “Connecting the Camera” (📖 87).



## **Connecting the Camera**

- 1 If the pictures you wish to copy are stored on a memory card, insert the card into the camera.
  - ◆ Windows users may require the Windows CD when starting the software for the first time.
  - Ⓛ Loss of power during transfer could result in loss of data or damage to internal memory or the memory card. Charge the battery before connecting the camera.
- 2 Turn the camera off and connect the supplied USB cable as shown, making sure the connectors are fully inserted. Connect the camera directly to the computer; do not use a USB hub or keyboard.

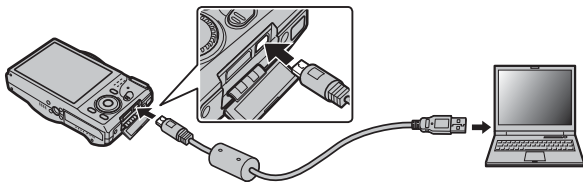

- 3 Press the  button for about a second to turn the camera on and follow the on-screen instructions to copy pictures to the computer. To exit without copying pictures, click **Cancel**.

For more information on using the supplied software, start the application and select the appropriate option from the **Help** menu.

- ❗ If a memory card containing a large number of images is inserted, there may be a delay before the software starts and you may be unable to import or save images. Use a memory card reader to transfer pictures.
- ❗ Make sure that the computer does not display a message stating that copying is in progress and that the indicator lamp is out before turning the camera off or disconnecting the USB cable (if the number of images copied is very large, the indicator lamp may remain lit after the message has cleared from the computer display). Failure to observe this precaution could result in loss of data or damage to internal memory or the memory card.
- ❗ Disconnect the camera before inserting or removing memory cards.
- ❗ In some cases, it may not be possible to access pictures saved to a network server using the supplied software in the same way as on a standalone computer.
- ❗ The user bears all applicable fees charged by the phone company or Internet service provider when using services that require an Internet connection.

 **Disconnecting the Camera**

After confirming that the indicator lamp is out, turn the camera off and disconnect the USB cable.

 **Uninstalling the Supplied Software**

Only uninstall the supplied software when it is no longer required or before beginning reinstallation. After quitting the software and disconnecting the camera, drag the “FinePixViewer” folder from “Applications” into the Trash and select **Empty Trash** in the **Finder** menu (Macintosh), or open the control panel and use “Programs and Features” (Windows 7/Windows Vista) or “Add or Remove Programs” (Windows XP) to uninstall MyFinePix Studio. Under Windows, one or more confirmation dialogs may be displayed; read the contents carefully before clicking **OK**.

# Menus

## Using the Menus: Shooting Mode

Use the **F**-mode and shooting menus to adjust shooting settings. The options available vary with the shooting mode selected.

### Using the **F**-Mode Menu

To display **F**-mode menu shooting options, press the **F** button in shooting mode. Highlight items and press the selector right to view options, then highlight an option and press **MENU/OK**. Press **DISP/BACK** to exit when settings are complete.

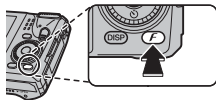

### **F**-Mode Menu Options

**ISO** ISO

(defaults to **AUTO**)

Control the camera's sensitivity to light. Higher values can reduce blur; note, however, that mottling may appear in pictures taken at high sensitivities.



Option	Description
<b>AUTO</b>	Sensitivity is adjusted automatically in response to shooting conditions.
<b>AUTO (3200) / AUTO (1600) / AUTO (800) / AUTO (400)</b>	As above, except that sensitivity will not be raised above the value in parentheses.
<b>12800 / 6400 / 3200 / 1600 / 800 / 400 / 200 / 100</b>	Sensitivity is set to the specified value, which is shown in the display.

## IMAGE SIZE

(defaults to **L** 4:3)

Choose the image size and aspect ratio at which pictures are recorded. Large pictures can be printed at large sizes with no drop in quality, while small pictures require less memory, allowing more pictures to be recorded.



### Size Versus Aspect Ratio

#### Size

Option	Prints at sizes up to
<b>L</b>	34×25 cm (13.5×10 in.)
<b>M</b>	24×18 cm (9.5×7 in.)
<b>S</b>	17×13 cm (7×5 in.)

#### Aspect ratio

**4:3:** Pictures have the same proportions as the camera display.

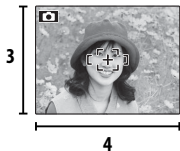



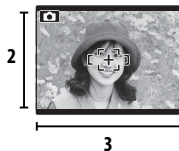



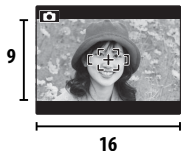



**3:2:** Pictures have the same proportions as a frame of 35 mm film.



**16:9:** Suited for display on High Definition (HD) devices.



**CONTINUOUS**(defaults to **OFF**)

Capture motion in a series of pictures (📖 46). Choose from , , , , , and **OFF** (F770EXR) or , , , , , and **OFF** (F750EXR).

**GPS LANDMARK NAVIGATOR (F770EXR Only)**

View landmark information (📖 71).

**GPS SET-UP (F770EXR Only)**

Access the following GPS options (📖 65).





Option	Description
<b>POWER SEARCH ON</b>	Immediately update GPS data. ❖ GPS data are not updated if <b>OFF</b> for <b>LOCATION SEARCH</b> .
<b>MY LANDMARK REGISTER</b>	Add custom landmarks, names, or photos to the map database, or edit or delete custom landmarks.
<b>LOCATION SEARCH</b>	Turn the GPS receiver on or off.
<b>LOCATION INFO</b>	Display GPS data.
<b>AUTO TIME CORRECTION</b>	Use GPS data to set the camera clock.
<b>TRACKING DATA</b>	Record GPS data.
<b>km/mile</b>	Choose the units used to display GPS information.
<b>PLACE NAME STAMP</b>	Choose <b>ON</b> to embed GPS data in photos (GPS data will not be embedded in movies, panoramas, or 3D photos). Note that GPS data can not be deleted; select <b>OFF</b> before shooting if you do not wish to record GPS data with your pictures.

**ADVANCED ANTI BLUR**(defaults to **ON**)

Select **ON** to enable advanced anti blur in  mode (🗨 24).

**FILM SIMULATION**(defaults to **STD**)

Simulate the effects of different types of film, including sepia and black-and-white.

Option	Description
 <b>PROVIA/STANDARD</b>	Standard color reproduction. Suited to a wide range of subjects, from portraits to landscapes.
 <b>Velvia/VIVID</b>	A high-contrast palette of saturated colors, suited to nature photographs.
 <b>ASTIA/SOFT</b>	A soft-toned palette of less saturated colors.
 <b>B&amp;W</b>	Take pictures in black and white.
 <b>SEPIA</b>	Take pictures in sepia.

## **Using the Shooting Menu**

To display the shooting menu, press **MENU/OK** in shooting mode. Highlight items and press the selector right to view options, then highlight an option and press **MENU/OK**. Press **DISP/BACK** to exit when settings are complete.

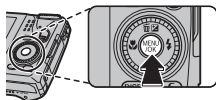

## **Shooting Menu Options**

### **EXR MODE**

(defaults to )

Choose an option for **EXR** mode (📖 23).

### **Adv. MODE**

(defaults to )

Choose an advanced shooting mode (📖 25).

### **SCENE POSITION**

(defaults to )

Choose a scene for **SP** mode (📖 33).

### **ISO**

(defaults to **AUTO**)

Control the camera's sensitivity to light (📖 90).

### **IMAGE SIZE**

(defaults to  **4:3**)

Choose image size and aspect ratio (📖 91).

### **IMAGE QUALITY**

(defaults to **F**)

Choose how much image files are compressed.

Option	Description
<b>FINE</b>	Low compression. Select for higher image quality.
<b>NORMAL</b>	High compression. Select this option to store more pictures.



**D-Rng DYNAMIC RANGE**(defaults to **AUTO**)

Control contrast. Higher values are recommended for scenes that include both sunlight and deep shade or for increased contrast with such subjects as sunlight on water, brightly-lit autumn leaves, portraits taken against a blue sky, and white objects or people wearing white; note, however, that mottling may appear in pictures taken at higher values. If **AUTO** is selected, the camera will automatically select values between 100% and 400% in response to shooting conditions.

Option	Description
<b>AUTO</b>	Increase contrast when shooting indoors or under overcast skies.
R100 100%	
R200 200%	
R400 400%	Reduce loss of detail in highlights and shadows when photographing high-contrast scenes.
R800 800%	
R1600 1600%	











⚙️ R1600 1600% and R800 800% are available only when **D-RANGE PRIORITY** is selected in **EXR** mode and an option other than **V** Velvia/VIVID or **S** ASTIA/SOFT is selected for **F** FILM SIMULATION.

**F** FILM SIMULATION(defaults to **STR**)

Simulate the effects of different types of film (📖 93).

**WB WHITE BALANCE**(defaults to **AUTO**)





If **AUTO** does not produce natural colors (for example, when taking close-ups), select  and measure a value for white balance or choose the option that matches the light source.



Option	Description
<b>AUTO</b>	White balance adjusted automatically.
	Measure a value for white balance.
	For subjects in direct sunlight.
	For subjects in the shade.
	Use under “daylight” fluorescent lights.
	Use under “warm white” fluorescent lights.
	Use under “cool white” fluorescent lights.
	Use under incandescent lighting.
	For underwater photography

 **Custom White Balance**

Choose  to adjust white balance for unusual lighting conditions. White balance measurement options will be displayed; frame a white object so that it fills the display and press the shutter button all the way down to measure white balance.

- If **“COMPLETED!”** is displayed, press **MENU/OK** to set white balance to the measured value.
- If **“UNDER”** is displayed, raise exposure compensation ( 39) and try again.
- If **“OVER”** is displayed, lower exposure compensation and try again.

 For greater precision, adjust  **FILM SIMULATION**,  **ISO**, and  **DYNAMIC RANGE** before measuring white balance.











-  At settings other than , auto white balance is used with the flash.
-  Results vary with shooting conditions. Play pictures back after shooting to check colors in the display.

**INTELLIGENT SHARPNESS**(defaults to **OFF**)

Select **ON** to process photos digitally for sharp, super high-resolution results.

- ◆ The time needed to record images increases.
- ◆ The effects are not visible in the display during shooting.
- ◆ Intelligent sharpness may turn off automatically in some modes.
- ◆ This option has no effect on photos taken in continuous mode.

**CONTINUOUS**(defaults to **OFF**)

Capture motion in a series of pictures (📖 46). Choose from , , , , , and **OFF** (F770EXR) or , , , , , and **OFF** (F750EXR).

**GPS MY LANDMARK REGISTER (F770EXR Only)**

Add custom landmarks, names, or photos to the map database, or edit or delete custom landmarks (📖 71).

**ADVANCED ANTI BLUR**(defaults to **ON**)



Select **ON** to enable advanced anti blur in  mode (📖 24).

**FACE DETECTION**

Choose whether the camera automatically detects and sets focus and exposure for human portrait subjects (📖 45).





**PHOTOMETRY**(defaults to )





Choose how the camera meters exposure when Intelligent Face Detection is off.

<b>Option</b>	<b>Description</b>
 <b>MULTI</b>	Automatic scene recognition is used to adjust exposure for a wide range of shooting conditions.
 <b>SPOT</b>	The camera meters lighting conditions at the center of the frame. Recommended when the background is much brighter or darker than the main subject.
 <b>AVERAGE</b>	Exposure is set to the average for the entire frame. Provides consistent exposure across multiple shots with the same lighting, and is particularly effective for landscapes and portraits of subjects dressed in black or white.

**AF MODE**

This option controls how the camera selects the focus area for photographs. Regardless of the option selected, the camera will focus on the subject in the center of the frame when macro mode is on.

Option	Description
 <b>CENTER</b>	The camera focuses on the subject in the center of the frame.
 <b>MULTI</b>	When the shutter button is pressed halfway, the camera detects high-contrast subjects near the center of the frame and selects the focus area automatically.
 <b>CONTINUOUS</b>	The camera continuously adjusts focus to reflect changes in the distance to the subject in the focus frame.
 <b>TRACKING</b>	Position the subject in the center focus area and press the selector left. Focus will track the subject as it moves through the frame.



- ◆ Note that in  and  modes, the camera focuses continuously, increasing the drain on the battery, and that the sound of the camera focusing may be audible.
- ◆ If a face is detected when  is selected, a  icon will be displayed and the camera will continuously adjust focus to maintain focus on the face.

**FACE RECOGNITION**

Add portrait subjects to the face recognition database. These subjects will be given priority during Intelligent Face Detection, and their names and other information can be viewed during playback (📖 54).

**MOVIE AF MODE** (defaults to )

This option controls how the camera selects the focus area for movies.

Option	Description
 <b>CENTER</b>	The camera focuses on the subject in the center of the frame.
 <b>CONTINUOUS</b>	The camera continuously adjusts focus to reflect changes in the distance to subjects near the center of the frame.



- Note that in  mode, the camera focuses continuously, increasing the drain on the battery, and that the sound of the camera focusing may be audible.

**MOVIE MODE** (defaults to )



Choose a frame size for movies ( 73).

**STILL SHOOTING IN MOVIE** (defaults to **MOVIE PRIORITY**)

Choose how the camera records photographs taken during movie recording ( 74).

Option	Description
<b>MOVIE PRIORITY</b>	The camera takes a photograph without interrupting movie recording. Image size is determined by the option selected for  <b>MOVIE MODE</b> .
<b>STILL IMAGE PRIORITY</b>	The camera interrupts filming to take the photograph and resumes filming automatically when recording is complete. Image size is determined by the option selected for  <b>IMAGE SIZE</b> , but note that the photograph will be recorded at size <b>M</b> if <b>L</b> is selected.

**AE BKT EV STEPS** (defaults to  $\pm 1/3$ )

Choose the size of the exposure bracketing increment used when  **AE BKT** is selected for  **CONTINUOUS**. Select from increments of  $+1/3$ EV,  $+2/3$ EV, and +1 EV (note that the camera may not be able to use the selected bracketing increment if the amount of over- or under- exposure exceeds the limits of the exposure metering system).

## Using the Menus: Playback Mode

---

The **F**-mode and playback menus are used to manage the pictures in internal memory or on the memory card.

### ***Using the F-Mode Menu***

To display **F**-mode menu playback options, press the **F** button in playback mode. Highlight items and press the selector right to view options, then highlight an option and press **MENU/OK**. Press **DISP/BACK** to exit when settings are complete.

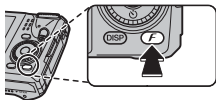

### ***F-Mode Menu Options***

#### **PHOTOBOOK ASSIST**

Create books from your favorite photos ( 60).

#### **LANDMARK NAVIGATOR (F770EXR Only)**

View landmark information ( 71).

#### **PHOTO NAVIGATION (F770EXR Only)**

View the direction and distance from your present position to the location where a picture was taken ( 69).

---

**GPS SET-UP (F770EXR Only)**

Access the following GPS options (📖 65).

Option	Description
<b>POWER SEARCH ON</b>	Immediately update GPS data. ❖ GPS data are not updated if <b>OFF</b> for <b>LOCATION SEARCH</b> .
<b>LOCATION INFO COPY</b>	Copy GPS data from one picture to another.
<b>LOCATION SEARCH</b>	Turn the GPS receiver on or off.
<b>LOCATION INFO</b>	Display GPS data.
<b>AUTO TIME CORRECTION</b>	Use GPS data to set the camera clock.
<b>TRACKING DATA</b>	Record GPS data.
<b>km/mile</b>	Choose the units used to display GPS information.
<b>PLACE NAME STAMP</b>	Choose <b>ON</b> to embed GPS data in photos (GPS data will not be embedded in movies, panoramas, or 3D photos). Note that GPS data can not be deleted; select <b>OFF</b> before shooting if you do not wish to record GPS data with your pictures.

**SLIDE SHOW***(defaults to MULTIPLE)*

View pictures in an automated slide show. Choose the type of show and press **MENU/OK** to start. Press **DISP/BACK** at any time during the show to view on-screen help. The show can be ended at any time by pressing **MENU/OK**.

Option	Description
<b>NORMAL</b>	Press selector left or right to go back or skip ahead one frame. Select <b>FADE-IN</b> for fade transitions between frames.
<b>FADE-IN</b>	
<b>NORMAL</b> 🗨️	As above, except that camera automatically zooms in on faces selected with Intelligent Face detection.
<b>FADE-IN</b> 🗨️	
<b>MULTIPLE</b>	Display several pictures at once.

❖ The camera will not turn off automatically while a slide show is in progress.



## **Using the Playback Menu**

To display the playback menu, press **MENU/OK** in playback mode. Highlight items and press the selector right to view options, then highlight an option and press **MENU/OK**. Press **DISP/BACK** to exit when settings are complete.

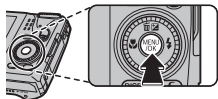

## **Playback Menu Options**

### **PHOTOBOOK ASSIST**

Create books from your favorite photos (📖 60).

### **LANDMARK NAVIGATOR (F770EXR Only)**

View landmark information (📖 71).

### **LOCATION INFO COPY (F770EXR Only)**

Copy GPS data from one picture to another (📖 70).

### **PHOTO NAVIGATION (F770EXR Only)**

View the direction and distance from your present position to the location where a picture was taken (📖 69).

### **IMAGE SEARCH**

Search for pictures (📖 59).

### **ERASE**

Delete all or selected pictures (📖 58).

### MARK FOR UPLOAD TO

Select pictures for upload to YouTube or Facebook using MyFinePix Studio (Windows only).

#### ■ Selecting Pictures for Upload

**1** Select **YouTube** to choose movies for upload to YouTube, **FACEBOOK** to choose photos and movies for upload to Facebook.

**2** Press the selector left or right to display pictures and press **MENU/OK** to select or deselect. Press **DISP/BACK** to exit when all the desired pictures are selected.

◆ Only movies can be selected for upload to YouTube.

◆ During playback, selected pictures are indicated by  **YouTube** or  **FACEBOOK** icons.

#### ■ RESET ALL: Deselecting All Pictures

Choose **RESET ALL** to deselect all pictures. If the number of pictures affected is very large, a message will be displayed while the operation is in progress. Press **DISP/BACK** to exit before the operation is complete.

#### ■ Uploading Pictures (Windows Only)

Selected pictures can be uploaded using the **YouTube/Facebook Upload** option in MyFinePix Studio.

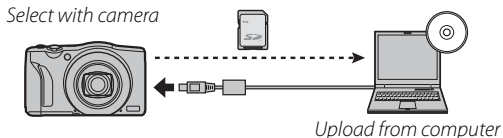

For information on installing MyFinePix Studio and connecting the camera to a computer, see "Viewing Pictures on a Computer" (📖 82).

**SLIDE SHOW**(defaults to **MULTIPLE**)

View pictures in an automated slide show (📖 102).

**RED EYE REMOVAL**

If the current picture is marked with a 👤 icon to indicate that it was taken with Intelligent Face Detection, this option can be used to remove red-eye. The camera will analyze the image; if red-eye is detected, the image will be processed to create a copy with reduced red-eye.

- 1 Display the desired picture.
- 2 Select **RED EYE REMOVAL** in the playback menu.
- 3 Press **MENU/OK**.

- ❖ Red eye may not be removed if the camera is unable to detect a face or the face is in profile. Results may differ depending on the scene. Red eye can not be removed from pictures that have already been processed using red-eye removal or pictures created with other devices.
- ❖ The amount of time needed to process the image varies with the number of faces detected.
- ❖ Copies created with **RED EYE REMOVAL** are indicated by a 👤 icon during playback.

**PROTECT**

Protect pictures from accidental deletion.

- 1 Select **PROTECT** in the playback menu.
  - 2 Highlight one of the following options and press **MENU/OK**:
    - **FRAME**: Protect selected pictures. Press the selector left or right to view pictures and press **MENU/OK** to select or deselect. Press **DISP/BACK** when the operation is complete.
    - **SET ALL**: Protect all pictures.
    - **RESET ALL**: Remove protection from all pictures.
- ⓘ Protected pictures will be deleted when the memory card or internal memory is formatted (📖 112).

### CROP

Create a cropped copy of the current picture.

- 1 Display the desired picture.
  - 2 Select  **CROP** in the playback menu.
  - 3 Use the zoom control to zoom in and out and use the selector to scroll the picture until the desired portion is displayed.
  - 4 Press **MENU/OK** to display a confirmation dialog.
  - 5 Press **MENU/OK** again to save the cropped copy to a separate file.
- ◆ Larger crops produce larger copies; all copies have an aspect ratio of 4:3. If the size of the final copy will be **640**, **OK** will be displayed in yellow.

### RESIZE

Create a small copy of the current picture.

- 1 Display the desired picture.
  - 2 Select  **RESIZE** in the playback menu.
  - 3 Highlight a size and press **MENU/OK** to display a confirmation dialog.
  - 4 Press **MENU/OK** to save the resized copy to a separate file.
- ◆ The sizes available vary with the size of the original image.
-

**IMAGE ROTATE**

Rotate pictures taken in tall orientation so that they are displayed in tall orientation in the LCD monitor.

- 1 Display the desired picture.
  - 2 Select **IMAGE ROTATE** in the playback menu.
  - 3 Press the selector down to rotate the picture 90° clockwise, up to rotate it 90° counterclockwise.
  - 4 Press **MENU/OK**. The picture automatically be displayed in the selected orientation whenever it is played back on the camera.
- ◆ Protected pictures can not be rotated. Remove protection before rotating pictures (📖 105).
  - ◆ The camera may not be able to rotate pictures created with other devices.

**COPY COPY**

Copy pictures from internal memory to a memory card.

- 1 Select **COPY COPY** in the playback menu.
  - 2 Highlight one of the following options and press the selector right:
    - **INTERNAL MEMORY → SD CARD**: Copy pictures from internal memory to a memory card.
    - **SD CARD → INTERNAL MEMORY**: Copy pictures from a memory card to internal memory.
  - 3 Highlight one of the following options and press **MENU/OK**:
    - **FRAME**: Copy selected pictures. Press the selector left or right to view pictures and press **MENU/OK** to copy the current picture.
    - **ALL FRAMES**: Copy all pictures.
- ◆ Copying ends when the destination is full.
  - ◆ DPOF print information is not copied (📖 80).

### VOICE MEMO

Add a voice memo to the current photograph. Holding the camera at a distance of about 20 cm, face the microphone and press **MENU/OK** to begin recording. Press **MENU/OK** again to end recording (recording ends automatically after 30 seconds).

- ◆ Voice memos can not be added to movies or protected pictures. Remove protection from pictures before recording voice memos.
- ◆ If a voice memo already exists for the current picture, the options will be displayed. Select **RE-REC** to replace the existing memo.

### **Playing Voice Memos**

Pictures with voice memos are indicated by a  icon during playback. To play the voice memo back, select **PLAY** for  **VOICE MEMO** in the playback menu.

- ◆ The camera may not play voice memos recorded with other devices.
- ◆ Do not cover the speaker during playback.

### ERASE FACE RECOG.

Remove face recognition links from the current image. When this option is selected, the camera will zoom in on an area in the current picture that it has matched with a face in the face recognition database. If the match is not correct, press **MENU/OK** to remove the link to the face recognition database.

- ◆ Face recognition links can not be removed from copies with a size of **640** or smaller.

### PRINT ORDER (DPOF)

Select pictures for printing on DPOF- and PictBridge-compatible devices ( 80).

**DISP ASPECT**

Choose how High Definition (HD) devices display pictures with an aspect ratio of 4:3 (this option is available only when an HDMI cable is connected). Select **16:9** to display the image so that it fills the screen with its top and bottom cropped out, **4:3** to display the entire image with black bands at either side.

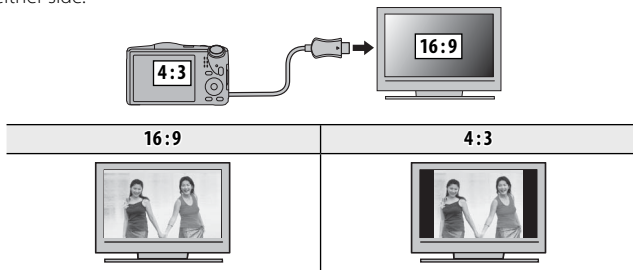

- ◆ Photographs with an aspect ratio of 16:9 are displayed full screen, those with an aspect ratio of 3:2 in a black frame.

# The Setup Menu

## Using the Setup Menu

### 1 Display the setup menu.

1.1 Press **MENU/OK** to display the menu for the current mode.

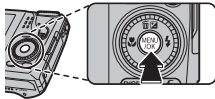

1.2 Press the selector left to highlight the tab for the current menu.

1.3 Press the selector down to highlight .

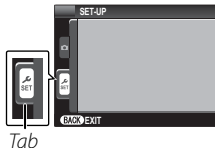

1.4 Press the selector right to place the cursor in the setup menu.

### 2 Adjust settings.

Highlight items and press the selector right to view options, then highlight an option and press **MENU/OK**. Press **DISP/BACK** to exit when settings are complete.



## ***Setup Menu Options***

### **DATE/TIME**



Set the camera clock ( 16).





### **TIME DIFFERENCE**

(defaults to )

Switch the camera clock instantly from your home time zone to the local time at your destination when traveling. To specify the difference between local time and your home time zone:

- 1 Highlight  **LOCAL** and press the selector right.
- 2 Use the selector to choose the time difference between local time and your home time zone.
- 3 Press **MENU/OK**.

To switch between local time and your home time zone, highlight  **LOCAL** or  **HOME** and press **MENU/OK**.

Option	Description
 <b>HOME</b>	Switch to the time currently selected for  <b>DATE/TIME</b> (see above).
 <b>LOCAL</b>	Switch to local time. If this option is selected,  and the time and date will be displayed in yellow for three seconds each time the camera is turned on.

### **言語/LANG.**

Choose a language.

### **SILENT MODE**

(defaults to **OFF**)

Select **ON** to disable the speaker, flash, and AF-assist illuminator in situations in which camera sounds or lights may be unwelcome (note that the flash will still fire in  mode).

### RESET

Reset all settings except  **DATE/TIME**,  **TIME DIFFERENCE**,  **BACKGROUND COLOR**, and  **VIDEO SYSTEM** to default values.

**1** Highlight  **RESET** and press the selector right to display a confirmation dialog.

**2** Highlight **OK** and press **MENU/OK**.

### FORMAT

If a memory card is inserted in the camera, this option will format the memory card. If no memory card is inserted, this option will format internal memory.

- ⓘ All data—including protected pictures—will be deleted from the memory card or internal memory. Be sure important files have been copied to a computer or other storage device.
- ⓘ Do not open the battery-chamber cover during formatting.

### SET-UP (F770EXR Only)

Access the following GPS options ( 65).

Option	Description
<b>POWER SEARCH ON</b>	Immediately update GPS data.  GPS data are not updated if <b>OFF</b> for <b>LOCATION SEARCH</b> .
<b>LOCATION SEARCH</b>	Turn the GPS receiver on or off.
<b>LOCATION INFO</b>	Display GPS data.
<b>AUTO TIME CORRECTION</b>	Use GPS data to set the camera clock.
<b>TRACKING DATA</b>	Record GPS data.
<b>km/mile</b>	Choose the units used to display GPS information.
<b>PLACE NAME STAMP</b>	Choose <b>ON</b> to embed GPS data in photos (GPS data will not be embedded in movies, panoramas, or 3D photos). Note that GPS data can not be deleted; select <b>OFF</b> before shooting if you do not wish to record GPS data with your pictures.

**IMAGE DISP.** (defaults to **1.5 SEC**)

Choose how long pictures are displayed in the LCD monitor after shooting.

Option	Description
<b>3 SEC</b>	Pictures are displayed for three seconds ( <b>3 SEC</b> ) or 1.5 seconds ( <b>1.5 SEC</b> ).
<b>1.5 SEC</b>	Colors may differ slightly from those in the final image.
<b>ZOOM (CONTINUOUS)</b>	Pictures are displayed until the <b>MENU/OK</b> button is pressed.
<b>OFF</b>	Pictures are not displayed after shooting.

**FRAME NO.** (defaults to **CONT.**)

New pictures are stored in image files named using a four-digit file number assigned by adding one to the last file number used. The file number is displayed during playback as shown at right. **FRAME NO.** controls whether file numbering is reset to 0001 when a new memory card is inserted or the current memory card or internal memory is formatted.

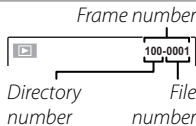

Option	Description
<b>CONTINUOUS</b>	Numbering continues from the last file number used or the first available file number, whichever is higher. Choose this option to reduce the number of pictures with duplicate file names.
<b>RENEW</b>	Numbering is reset to 0001 after formatting or when a new memory card is inserted.

- ❖ If the frame number reaches 999-9999, the shutter release will be disabled (133).
- ❖ Selecting **RESET** (112) sets **FRAME NO.** to **CONTINUOUS** but does not reset the file number.
- ❖ Frame numbers for pictures taken with other cameras may differ.

### OPERATION VOL. (defaults to )

Adjust the volume of the sounds produced when camera controls are operated. Choose  **OFF** (mute) to disable control sounds.

### SHUTTER VOLUME (defaults to )

Adjust the volume of the sounds produced when the shutter is released. Choose  **OFF** (mute) to disable the shutter sound.

### SHUTTER SOUND (defaults to )

Choose the sound made by the shutter.

### PLAYBACK VOLUME (defaults to **7**)

Adjust the volume for movie and voice memo playback.

### LCD BRIGHTNESS (defaults to **0**)

Control the brightness of the display.

### MONITOR SUNLIGHT MODE (defaults to **OFF**)

Select **ON** to make the display in the monitor easier to read in bright light ( 6).

### AUTO POWER OFF (defaults to **2 MIN**)

Choose the length of time before the camera turns off automatically when no operations are performed. Shorter times increase battery life; if **OFF** is selected, the camera must be turned off manually. Note that in some situations the camera turns off automatically even when **OFF** is selected.

### Fn BUTTON (defaults to LANDMARK NAVIGATOR (F770EXR) / ISO (F750EXR))

Choose the role played by the **Fn** button ( 44).

---

**DUAL IS MODE**(defaults to **CONTINUOUS**)

Choose from the following image stabilization options:

Option	Description
<b>CONTINUOUS + MOTION</b>	Image stabilization on. If <b>+ MOTION</b> is selected, the camera will adjust shutter speed to reduce motion blur when a moving objects are detected.
<b>CONTINUOUS</b>	
<b>SHOOTING + MOTION</b>	As above, except that image stabilization is performed only when the shutter button is pressed halfway or the shutter is released.
<b>SHOOTING ONLY</b>	
<b>OFF</b>	Image stabilization off. Choose this option when using a tripod.

**+ MOTION** has no effect when sensitivity is set to a fixed value, and may also be unavailable at some other combinations of settings. The effect may vary with lighting conditions and the speed at which the object is moving.

**RED EYE REMOVAL**(defaults to **ON**)

Choose **ON** to remove red-eye effects caused by the flash when shooting with Intelligent Face Detection.

- Red-eye reduction is performed only when a face is detected.
- Red-eye removal is not available with RAW images.

**INTELLIGENT DIGITAL ZOOM**(defaults to **OFF**)

If **ON** is selected, selecting  at the maximum optical zoom position triggers intelligent digital zoom, further magnifying the image while processing it for sharp, high-resolution results.

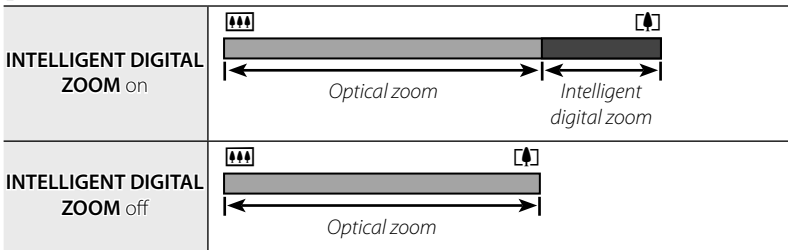
**The Zoom Indicator**

- ◆ Selecting another mode may end intelligent digital zoom and restore maximum optical zoom.
- ◆ In **EXR** mode, the camera will match the **EXR** mode to the scene for zoom ratios of up to 40x when combined with optical zoom.
- ◆ Intelligent digital zoom may sometimes produce lower quality images than optical zoom.
- ◆ The time needed to record images increases.
- ◆ The effects are not visible in the display during shooting.
- ◆ Intelligent digital zoom is not available in continuous mode or during movie recording.

**AF ILLUMINATOR**(defaults to **ON**)

If **ON** is selected, the AF-assist illuminator will light to assist autofocus.

- ⓘ The camera may be unable to focus using the AF-assist illuminator in some cases. If the camera is unable to focus in macro mode, try increasing the distance to the subject.
- ⓘ Avoid shining the AF-assist illuminator directly into your subject's eyes.

**RAW (F770EXR Only)**(defaults to **OFF**)

Choose **RAW+JPEG** or **RAW** to record RAW pictures (note that because RAW data are not processed on the camera, RAW pictures must be copied to a computer for processing). If **RAW+JPEG** is selected, JPEG copies will also be recorded. Choose **OFF** to record pictures in JPEG format only.

- 🔗 To convert RAW files for display on a computer, use the supplied RAW File Converter software.
- ⓘ Crop, resize, and red-eye removal are not available with RAW images. The maximum zoom available when viewing RAW images is 3.2 x.

**SAVE ORG IMAGE**(defaults to **OFF**)

Choose **ON** to save unprocessed copies of seamless  panoramas or pictures taken using  **RED EYE REMOVAL**,  **PRO LOW-LIGHT MODE**, or  **PRO FOCUS MODE**.

**AUTOROTATE PB**(defaults to **ON**)

Choose **ON** to automatically rotate “tall” (portrait-orientation) pictures during playback.

**BACKGROUND COLOR**

Choose a color scheme.

**GUIDANCE DISPLAY**(defaults to **ON**)

Choose whether to display tool tips.

### VIDEO SYSTEM



Choose a video mode for connection to a TV.

Option	Description
<b>NTSC</b>	Select this mode for connection to video devices in North America, the Caribbean, parts of Latin America, and some East Asian countries.
<b>PAL</b>	Select this mode for connection to video devices in the United Kingdom and much of Europe, Australia, New Zealand, and parts of Asia and Africa.

### POWER MANAGEMENT

(defaults to )

Optimize camera performance for increased battery life or display quality.

Option	Description
 <b>POWER SAVE</b>	Reduces display refresh rate. The display dims to save power if no operations are performed for a short period, but can be restored by operating camera controls. Select this option to save power.
 <b>CLEAR DISPLAY</b>	Choose this option for a brighter, higher quality display and for a longer delay before the monitor dims to save power.

  **POWER SAVE** does not take effect when Intelligent Face Detection is on.



**DATE DATE STAMP**(defaults to **OFF**)

Stamp the time and/or date of recording on photographs as they are taken.

Option	Description
+	Stamp new photographs with the date and time of recording.
	Stamp new photographs with the date of recording.
<b>OFF</b>	Do not stamp the time and date on new photographs.

- ① Time and date stamps can not be deleted. Turn **DATE DATE STAMP** off to prevent time and date stamps appearing on new photographs.
- ① If the camera clock is not set, you will be prompted to set the clock to the current date and time (📖 16).
- ① We recommend that you turn the DPOF “print date” option off when printing images with a time and date stamp (📖 80).
- ① Time and date stamps do not appear on movies, panoramas, or 3D photos.

**STARTUP START-UP SCREEN**(defaults to **OFF**)

Choose whether the camera displays a splash screen at startup.

**GPS DEMONSTRATION (F770EXR Only)**(defaults to **OFF**)

Choose **ON** for a GPS demo. This option should normally be left **OFF**.

# Technical Notes

## Optional Accessories



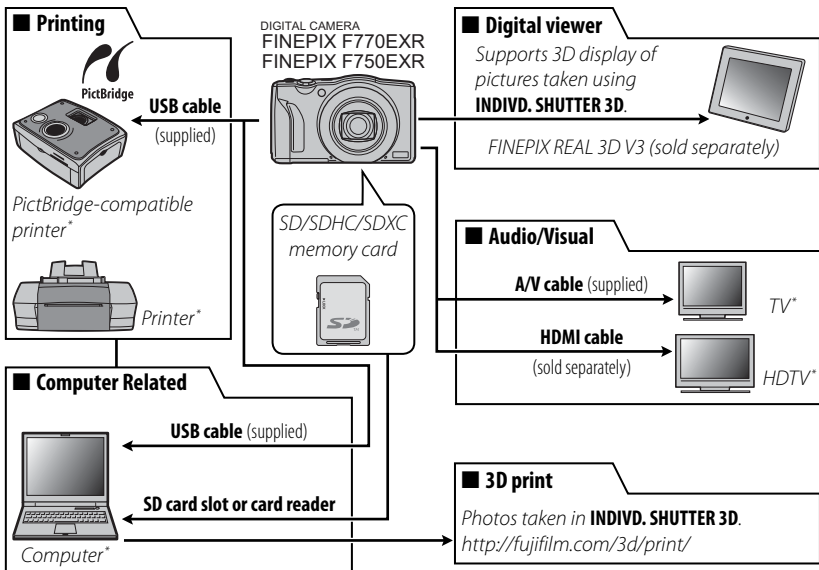

The camera supports a wide range of accessories from FUJIFILM and other manufacturers.

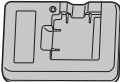

\* Available separately.

## **Accessories from FUJIFILM**

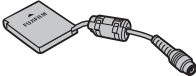
The following optional accessories are available from FUJIFILM. For the latest information on the accessories available in your region, check with your local FUJIFILM representative or visit [http://www.fujifilm.com/products/digital\\_cameras/index.html](http://www.fujifilm.com/products/digital_cameras/index.html).

<b>Rechargeable Li-ion batteries</b>	<b>NP-50:</b> Additional large-capacity NP-50 rechargeable batteries can be purchased as required. The F750EXR can be used with NP-50 batteries only; note that when used with the F770EXR, the NP-50 may record fewer photos per charge than the NP-50A.	
<b>Battery chargers</b>	<b>BC-45W:</b> Replacement battery chargers can be purchased as required. The BC-45W charges an NP-50A/NP-50 battery in about 150 minutes at +20 °C (+68 °F).	
<b>AC power adapters</b>	<b>AC-5VX</b> (requires CP-50 DC coupler): Use for extended playback or when copying pictures to a computer (shape of adapter and plug vary with region of sale).	
<b>DC couplers</b>	<b>CP-50:</b> Connect the AC-5VX to the camera.	
<b>Digital viewer</b>	<b>FINEPIX REAL 3D V3:</b> View 3D images without 3D glasses.	

## Caring for the Camera

---

To ensure continued enjoyment of the product, observe the following precautions.

### **Storage and Use**

If the camera will not be used for an extended period, remove the battery and memory card. Do not store or use the camera in locations that are:

- exposed to rain, steam, or smoke
- very humid or extremely dusty
- exposed to direct sunlight or very high temperatures, such as in a closed vehicle on a sunny day
- extremely cold
- subject to strong vibration
- exposed to strong magnetic fields, such as near a broadcasting antenna, power line, radar emitter, motor, transformer, or magnet
- in contact with volatile chemicals such as pesticides
- next to rubber or vinyl products

### ■ **Water and Sand**

Exposure to water and sand can also damage the camera and its internal circuitry and mechanisms. When using the camera at the beach or seaside, avoid exposing the camera to water or sand. Do not place the camera on a wet surface.

### ■ **Condensation**

Sudden increases in temperature, such as occur when entering a heated building on a cold day, can cause condensation inside the camera. If this occurs, turn the camera off and wait an hour before turning it on again. If condensation forms on the memory card, remove the card and wait for the condensation to dissipate.

**Cleaning**

Use a blower to remove dust from the lens and LCD monitor, then gently wipe with a soft, dry cloth. Any remaining stains can be removed by wiping gently with a piece of FUJIFILM lens-cleaning paper to which a small amount of lens-cleaning fluid has been applied. Care should be taken to avoid scratching the lens or LCD monitor. The camera body can be cleaned with a soft, dry cloth. Do not use alcohol, thinner, or other volatile chemicals.













**Traveling**

Keep the camera in your carry-on baggage. Checked baggage may suffer violent shocks that could damage the camera.

# Troubleshooting

## Problems and Solutions

### Power and Battery

Problem	Solution
The camera does not turn on.	<ul style="list-style-type: none"><li>• <b>The battery is exhausted:</b> Charge the battery or insert a fully-charged spare battery (📖 7).</li><li>• <b>The battery is inserted incorrectly:</b> Reinsert in the correct orientation (📖 9).</li><li>• <b>The battery-chamber cover is not latched:</b> Latch the battery-chamber cover (📖 9).</li><li>• <b>The AC power adapter and DC coupler are connected incorrectly:</b> Reconnect the AC power adapter and DC coupler.</li></ul>
The battery runs down quickly.	<ul style="list-style-type: none"><li>• <b>The battery is cold:</b> Warm the battery by placing it in a pocket or other warm place and reinsert it in the camera immediately before taking a picture.</li><li>• <b>There is dirt on the battery terminals:</b> Clean the terminals with a soft, dry cloth.</li><li>•  <b>CLEAR DISPLAY is selected for  POWER MANAGEMENT:</b> Select  <b>POWER SAVE</b> to reduce the drain on the battery (📖 118).</li><li>• <b>ON is selected for  MONITOR SUNLIGHT MODE:</b> Select <b>OFF</b> to reduce the drain on the battery (📖 6).</li><li>•  <b>is selected for shooting mode:</b> Select  mode to reduce the drain on the battery (📖 22).</li><li>•  <b>CONTINUOUS</b> or  <b>TRACKING is selected for  AF MODE:</b> Select a different AF mode (📖 99).</li><li>• <b>The battery has been charged many times:</b> The battery has reached the end of its charging life. Purchase a new battery.</li><li>• <b>PERMANENTLY ON is selected for  LOCATION SEARCH:</b> Select <b>WHEN SWITCHED ON</b> or <b>OFF</b> (📖 65, 92).</li><li>•  <b>TRACKING DATA is on:</b> Turn  <b>TRACKING DATA</b> off (📖 65, 92).</li></ul>
The camera turns off suddenly.	<ul style="list-style-type: none"><li>• <b>The battery is exhausted:</b> Charge the battery or insert a fully-charged spare battery (📖 7).</li><li>• <b>The AC power adapter or DC coupler has been disconnected:</b> Reconnect the AC power adapter and DC coupler.</li></ul>

Problem	Solution
Charging does not start.	Reinsert the battery in the correct orientation and make sure that the charger is plugged in (📖 7).
Charging is slow.	Charge the battery at room temperature (📖 vi).
The charging lamp lights, but the battery does not charge.	<ul style="list-style-type: none"> <li>• <b>There is dirt on the battery terminals:</b> Clean the terminals with a soft, dry cloth.</li> <li>• <b>The battery has been charged many times:</b> The battery has reached the end of its charging life. Purchase a new battery. If the battery still fails to charge, contact your FUJIFILM dealer.</li> <li>• <b>The battery is too hot or too cold:</b> Wait for the battery temperature to stabilize (📖 7).</li> </ul>

## Menus and Displays

Problem	Solution
Menus and displays are not in English.	Select <b>ENGLISH</b> for 🗨️ 言語/LANG. (📖 16, 111).



## Shooting

Problem	Solution
No picture is taken when the shutter button is pressed.	<ul style="list-style-type: none"> <li>• <b>Memory is full:</b> Insert a new memory card or delete pictures (📖 10, 58).</li> <li>• <b>Memory is not formatted:</b> Format the memory card or internal memory (📖 112).</li> <li>• <b>There is dirt on the memory card contacts:</b> Clean the contacts with a soft, dry cloth.</li> <li>• <b>The memory card is damaged:</b> Insert a new memory card (📖 10).</li> <li>• <b>The battery is exhausted:</b> Charge the battery or insert a fully-charged spare battery (📖 7).</li> <li>• <b>The camera has turned off automatically:</b> Turn the camera on (📖 14).</li> <li>• <b>The indicator lamp was orange when you attempted to record a panorama:</b> Wait until the indicator lamps turns off (📖 3).</li> </ul>
The LCD monitor goes dark after shooting.	The LCD monitor may darken while the flash charges. Wait for the flash to charge (📖 41).
3D images do not turn out as expected.	Use a tripod or change the distance the camera is moved between the first and second shots (📖 31)

Problem	Solution
The camera does not focus.	<ul style="list-style-type: none"> <li>• <b>The subject is close to the camera:</b> Select macro mode (📖 40).</li> <li>• <b>The subject is far away from the camera:</b> Cancel macro mode (📖 40).</li> <li>• <b>The subject is not suited to autofocus:</b> Use focus lock (📖 37).</li> </ul>
Pictures are not the same size.	If <b>AUTO</b> is selected for <b>IMAGE SIZE</b> in <b>EXPOS</b> mode, the camera will optimize not only sensitivity and other settings, but also image size. To record all pictures at the same size, choose another shooting mode or select another option for <b>IMAGE SIZE</b> (📖 91).
Macro mode is not available.	Choose a different shooting mode (📖 22).
GPS	<ul style="list-style-type: none"> <li>• <b>The camera is slow to acquire GPS data:</b> Some time may be needed to acquire GPS data immediately after the camera or <b>GPS LOCATION SEARCH</b> is turned on or if the camera has been unable to acquire GPS data for an extended period (📖 65, 92).</li> <li>• <b>Location data are incorrect:</b> Select <b>OFF</b> for <b>GPS DEMONSTRATION</b> (📖 119).</li> <li>• <b>Landmark names are displayed on pictures :</b> <b>GPS PLACE NAME STAMP</b> is on. GPS data can not be deleted; to avoid recording the location with subsequent pictures, turn <b>GPS PLACE NAME STAMP</b> off (📖 92).</li> </ul>
Intelligent Face Detection is not available.	<b>Intelligent Face Detection is not available in the current shooting mode:</b> Choose a different shooting mode (📖 22).
No face is detected.	<ul style="list-style-type: none"> <li>• <b>The subject's face is obscured by sunglasses, a hat, long hair, or other objects:</b> Remove the obstructions.</li> <li>• <b>The subject's face occupies only a small area of the frame:</b> Change the composition so that the subject's face occupies a larger area of the frame (📖 37).</li> <li>• <b>The subject's head is tilted or horizontal:</b> Ask the subject to hold their head straight.</li> <li>• <b>The camera is tilted:</b> Keep the camera level (📖 18).</li> <li>• <b>The subject's face is poorly lit:</b> Shoot in bright light.</li> </ul>
Wrong subject is selected.	The selected subject is closer to the center of the frame than the main subject. Recompose the picture or turn face detection off and frame the picture using focus lock (📖 37).





Problem	Solution
The flash does not fire.	<ul style="list-style-type: none"> <li>• <b>The flash is not available in the current shooting mode:</b> Choose a different shooting mode (📖 22).</li> <li>• <b>The battery is exhausted:</b> Charge the battery or insert a fully-charged spare battery (📖 7).</li> <li>• <b>The camera is in continuous mode:</b> Select <b>OFF</b> for  <b>CONTINUOUS</b> (📖 46).</li> <li>• <b>The camera is in silent mode:</b> Turn silent mode off (📖 111).</li> <li>• <b>The flash is not raised:</b> Raise the flash (📖 41).</li> </ul>
Some flash modes are not available.	<ul style="list-style-type: none"> <li>• <b>The desired flash mode is not available in the current shooting mode:</b> Choose a different shooting mode (📖 22).</li> <li>• <b>The camera is in silent mode:</b> Turn silent mode off (📖 111).</li> </ul>
The flash does not fully light the subject.	<ul style="list-style-type: none"> <li>• <b>The subject is not in range of the flash:</b> Position the subject in range of the flash (📖 139).</li> <li>• <b>The flash window is obstructed:</b> Hold the camera correctly (📖 18).</li> <li>• <b>Fast shutter speed selected:</b> Choose a slower shutter speed (📖 35, 36).</li> </ul>
Pictures are blurred.	<ul style="list-style-type: none"> <li>• <b>The lens is dirty:</b> Clean the lens (📖 123).</li> <li>• <b>The lens is blocked:</b> Keep objects away from the lens (📖 18).</li> <li>• <b>!AF is displayed during shooting and the focus frame is displayed in red:</b> Check focus before shooting (📖 131).</li> <li>• <b>!CF is displayed during shooting:</b> Use the flash or a tripod (📖 42).</li> </ul>
Pictures are mottled.	<ul style="list-style-type: none"> <li>• <b>A slow shutter speed is selected at high temperatures:</b> This is normal and does not indicate a malfunction.</li> <li>• <b>The camera has been used continuously at high temperatures or a temperature warning is displayed:</b> Turn the camera off and wait for it to cool down.</li> </ul>
Pictures are not recorded.	<p>Power was interrupted during shooting. Before connecting the AC power adapter or DC coupler, turn the camera off. Leaving the camera on can result in corrupted files or damage to the memory card or internal memory.</p>

Problem	Solution
Sounds made by the camera are recorded with movies.	<ul style="list-style-type: none"> <li>•  <b>CONTINUOUS is selected for  MOVIE AF MODE:</b> Select a different AF mode (📖 100).</li> <li>• <b>Zoom was adjusted during shooting:</b> Do not adjust zoom during shooting.</li> <li>• <b>Intelligent Face Detection is on:</b> Turn Intelligent Face Detection off (📖 45).</li> </ul>



## Playback

Problem	Solution
Pictures are grainy.	The pictures were taken with a different make or model of camera.
No sound in movie playback.	<ul style="list-style-type: none"> <li>• <b>Playback volume is too low:</b> Adjust playback volume (📖 114).</li> <li>• <b>The microphone was obstructed:</b> Hold the camera correctly during recording (📖 18, 41).</li> <li>• <b>The speaker is obstructed:</b> Hold the camera correctly during playback (📖 75).</li> </ul>
Selected pictures are not deleted.	Some of the pictures selected for deletion are protected. Remove protection using the device with which it was originally applied (📖 105).
File numbering is unexpectedly reset.	The battery-chamber cover was opened while the camera was on. Turn the camera off before opening the battery-chamber cover (📖 14).

## Connections/Miscellaneous





Problem	Solution
No picture or sound.	<ul style="list-style-type: none"> <li>• <b>The camera is not properly connected:</b> Connect the camera properly (📖 76).</li> <li>• <b>An A/V cable was connected during movie playback:</b> Connect the camera once movie playback has ended.</li> <li>• <b>Input on the television is set to “TV”:</b> Set input to “VIDEO”.</li> <li>• <b>The camera is not set to the correct video standard:</b> Match the camera  <b>VIDEO SYSTEM</b> setting to the TV (📖 118).</li> <li>• <b>The volume on the TV is too low:</b> Adjust the volume.</li> </ul>
No color	Match the camera  <b>VIDEO SYSTEM</b> setting to the TV (📖 118).



Problem	Solution
The computer does not recognize the camera.	Be sure the camera and computer are correctly connected (📖 87).
Can not transfer RAW or JPEG files to computer.	Use the bundled software to transfer pictures (📖 82).
Pictures can not be printed.	<ul style="list-style-type: none"> <li>• <b>The camera is not properly connected:</b> Connect the camera correctly (📖 78).</li> <li>• <b>The printer is off:</b> Turn the printer on.</li> </ul>
Only one copy is printed/ the date is not printed.	The printer is not PictBridge compatible.
The camera is unresponsive.	<ul style="list-style-type: none"> <li>• <b>Temporary camera malfunction:</b> Remove and reinsert the battery (📖 9) or disconnect and reconnect the AC power adapter/DC coupler.</li> <li>• <b>The battery is exhausted:</b> Charge the battery (📖 7) or insert a fully-charged spare battery (📖 9).</li> </ul>
The camera does not function as expected.	Remove and reinsert the battery (📖 9) or disconnect and reconnect the AC power adapter/DC coupler. If the problem persists, contact your FUJIFILM dealer.
I want to use an AC power adapter and DC coupler overseas.	Check the label on the AC power adapter. The AC power adapter can be used with voltages of 100 – 240V. Consult your travel agent for information on plug adapters.
No sound.	Turn silent mode off (📖 111).

Problem	Solution
Hue or content of display changes unexpectedly.	Choose <b>OFF</b> for  <b>MONITOR SUNLIGHT MODE</b> (📖 6).
Time and date stamps	<ul style="list-style-type: none"><li>• <b>Time and date stamps are not correct:</b> Set the camera clock (📖 16).</li><li>• <b>Time and date stamps appear on photographs:</b> Time and date stamps can not be deleted. To prevent stamps appearing on new photographs, select <b>OFF</b> for  <b>DATE STAMP</b> (📖 119).</li></ul>
FinePixViewer can not be installed or does not start.	FinePixViewer does not support Mac OS X version 10.7 or later. Use one of the applications supplied with Mac OS X or purchase other software.



## Warning Messages and Displays

The following warnings are displayed in the LCD monitor:

Warning	Description
 (red)	Low battery. Charge the battery (📖 7) or insert a fully-charged spare battery (📖 9).
 (blinks red)	Battery exhausted. Charge the battery (📖 7) or insert a fully-charged spare battery (📖 9).
	Slow shutter speed. Pictures may be blurred; use the flash or a tripod.
<b>!AF</b> (displayed in red with red focus frame)	The camera can not focus. Try one of the following solutions: <ul style="list-style-type: none"><li>• Use focus lock to focus on another subject at the same distance, then recompose the picture (📖 37).</li><li>• Use macro mode to focus when taking close-ups (📖 40).</li></ul>
Aperture or shutter speed displayed in red	The subject is too bright or too dark and the picture will be over- or under-exposed. If the subject is dark, use the flash (📖 41).
FOCUS ERROR	
TURN OFF THE CAMERA AND TURN ON AGAIN	Camera malfunction or moving parts of lens obstructed. Turn the camera off and then on again, taking care not to touch the lens. If the message persists, contact a FUJIFILM dealer.
LENS CONTROL ERROR	
CARD NOT INITIALIZED	<ul style="list-style-type: none"><li>• <b>The memory card or internal memory is not formatted or the memory card was formatted in a computer or other device:</b> Format the memory card or internal memory using the  <b>FORMAT</b> option in the camera setup menu (📖 112).</li><li>• <b>The memory card contacts require cleaning:</b> Clean the contacts with a soft, dry cloth. If the message is repeated, format the card (📖 112). If the message persists, replace the card.</li><li>• <b>Camera malfunction:</b> Contact a FUJIFILM dealer.</li></ul>
PROTECTED CARD	The memory card is locked. Unlock the card (📖 10).
BUSY	The memory card is incorrectly formatted. Use the camera to format the card (📖 112).
	Turn the camera off and wait for it to cool. If no action is taken, the camera will turn off automatically.

Warning	Description
CARD ERROR	The memory card is not formatted for use in the camera. Format the card (📖 112).
	The memory card contacts require cleaning or the memory card is damaged. Clean the contacts with a soft, dry cloth. If the message is repeated, format the card (📖 112). If the message persists, replace the card.
	Incompatible memory card. Use a compatible card (📖 12).
	Camera malfunction. Contact a FUJIFILM dealer.
 MEMORY FULL	The memory card or internal memory is full and pictures can not be recorded or copied. Delete pictures or insert a memory card with more free space.
 MEMORY FULL	
INTERNAL MEMORY IS FULL	
INSERT A NEW CARD	
WRITE ERROR	<ul style="list-style-type: none"> <li>• <b>Memory card error or connection error:</b> Reinsert the card or turn the camera off and then on again. If the message persists, contact a FUJIFILM dealer.</li> </ul>
	<ul style="list-style-type: none"> <li>• <b>Not enough memory remaining to record additional pictures:</b> Delete pictures or insert a memory card with more free space.</li> </ul>
	<ul style="list-style-type: none"> <li>• <b>The memory card or internal memory is not formatted:</b> Format the memory card or internal memory (📖 112).</li> </ul>
READ ERROR	<ul style="list-style-type: none"> <li>• <b>The file is corrupt or was not created with the camera:</b> The file can not be viewed.</li> </ul>
	<ul style="list-style-type: none"> <li>• <b>The memory card contacts require cleaning:</b> Clean the contacts with a soft, dry cloth. If the message is repeated, format the card (📖 112). If the message persists, replace the card.</li> </ul>
	<ul style="list-style-type: none"> <li>• <b>Camera malfunction:</b> Contact a FUJIFILM dealer.</li> </ul>

Warning	Description
FRAME NO. FULL	The camera has run out of frame numbers (current frame number is 999-9999). Format the memory card and select <b>RENEW</b> for <b>FRAME NO.</b> Take a picture to reset frame numbering to 100-0001, then select <b>CONTINUOUS</b> for <b>FRAME NO.</b> (📖 113).
PRESS AND HOLD THE DISP BUTTON TO DEACTIVATE SILENT MODE	An attempt was made to choose a flash mode or adjust the volume with the camera in silent mode. Exit silent mode before choosing a flash mode or adjusting the volume (📖 111).
TOO MANY FRAMES	<ul style="list-style-type: none"> <li>• <b>A search has returned more than 30,000 results:</b> Choose a search that returns fewer results.</li> <li>• <b>More than 999 images are selected for deletion:</b> Choose fewer images.</li> </ul>
PROTECTED FRAME	An attempt was made to delete, rotate, or add a voice memo to a protected picture. Remove protection and try again (📖 105).
CAN NOT CROP	pictures can not be cropped.
CAN NOT CROP	The picture is damaged or was not created with the camera.
CANNOT EXECUTE	An attempt was made to create a resized copy at a size equal to or larger than the original. Choose a smaller size.
CANNOT EXECUTE	
CANNOT EXECUTE	
CAN NOT ROTATE	An attempt was made to rotate a picture that can not be rotated.
CAN NOT ROTATE	Movies can not be rotated.
CANNOT EXECUTE	Red-eye removal can not be applied to the selected picture.
CANNOT EXECUTE	Red-eye removal can not be applied to movies.
NO CARD	No memory card inserted when <b>COPY</b> is selected. Insert a memory card.

Warning	Description
SD NO IMAGE	The source selected for  COPY contains no images. Select a different source.
iF NO IMAGE	
! ERROR	<ul style="list-style-type: none"> <li>• <b>The voice memo file is corrupt:</b> The voice memo can not be played back.</li> <li>• <b>Camera malfunction:</b> Contact a FUJIFILM dealer.</li> </ul>
DPOF FILE ERROR	The DPOF print order on the current memory card contains more than 999 images. Copy the pictures to internal memory and create a new print order.
CAN NOT SET DPOF	The picture can not be printed using DPOF.
 CAN NOT SET DPOF	Movies can not be printed using DPOF.
COMMUNICATION ERROR	A connection error occurred while pictures were being printed or copied to a computer or other device. Confirm that the device is turned on and that the USB cable is connected.
PRINTER ERROR	Printer out of paper or ink, or other printer error. Check printer (see printer manual for details). To resume printing, turn the printer off and then turn it back on.
PRINTER ERROR RESUME?	Printer out of paper or ink, or other printer error. Check printer (see printer manual for details). If printing does not resume automatically, press <b>MENU/OK</b> to resume.
CANNOT BE PRINTED	An attempt was made to print a movie, a picture not created with the camera, or a picture in a format not supported by the printer. Movies and some pictures created with other devices can not be printed; if the picture is a still picture created with the camera, check the printer manual to confirm that the printer supports the JFIF-JPEG or Exif-JPEG format. If it does not, the pictures can not be printed.



# Appendix

## Internal Memory/Memory Card Capacity

The following table shows the recording time or number of pictures available at different image sizes. All figures are approximate; file size varies with the scene recorded, producing wide variations in the number of files that can be stored, and the number of exposures or length remaining may not diminish at an even rate. A limited number of test pictures can be taken when no memory card is inserted.

### ■ FinePix F770EXR

Medium ☐		Internal memory (approx. 30 MB)		4 GB		8 GB	
		FINE	NORMAL	FINE	NORMAL	FINE	NORMAL
Photographs	<b>L</b> 4:3	4	7	610	970	1240	1970
	<b>L</b> 16:9	6	10	810	1290	1650	2620
	<b>M</b> 4:3	7	14	970	1900	1970	3850
	<b>M</b> 16:9	10	19	1280	2480	2590	5030
	<b>S</b> 4:3	15	28	1900	3570	3850	7250
	<b>S</b> 16:9	27	41	3470	5060	7040	10270
Movies	<b>HS 1920</b> <sup>1</sup>	15 sec.		37 min.		76 min.	
	<b>HD 1280</b> <sup>1</sup>	20 sec.		48 min.		98 min.	
	<b>640</b> <sup>2</sup>	51 sec.		113 min.		229 min.	
	<b>HS 640 × 480</b> <sup>3</sup>	38 sec.		84 min.		171 min.	
	<b>HS 320 × 240</b> <sup>3</sup>	77 sec.		168 min.		342 min.	
	<b>HS 320 × 112</b> <sup>3</sup>	38 sec.		84 min.		171 min.	

1 Use a **CLASS 4** card or better. Individual movies can not exceed 29 minutes in length.

2 Individual movies can not exceed 120 minutes in length.

3 Use a **CLASS 4** card or better. Individual movies can not exceed 30 seconds in length.

## ■ FinePix F750EXR

Medium		Internal memory (approx. 25 MB)		4 GB		8 GB	
		FINE	NORMAL	FINE	NORMAL	FINE	NORMAL
Photographs	<b>L</b> 4:3	3	6	620	990	1250	1990
	<b>L</b> 16:9	5	8	830	1310	1670	2640
	<b>M</b> 4:3	6	12	990	1930	1990	3880
	<b>M</b> 16:9	8	15	1300	2530	2620	5080
	<b>S</b> 4:3	12	23	1930	3640	3880	7320
	<b>S</b> 16:9	22	33	3540	5160	7110	10370
Movies	<b>HD</b> 1920 <sup>1</sup>	12 sec.		38 min.		76 min.	
	<b>HD</b> 1280 <sup>1</sup>	16 sec.		49 min.		98 min.	
	<b>640</b> <sup>2</sup>	40 sec.		115 min.		232 min.	
	<b>HS</b> 640 × 480 <sup>3</sup>	30 sec.		85 min.		172 min.	
	<b>HS</b> 320 × 240 <sup>3</sup>	62 sec.		172 min.		345 min.	
	<b>HS</b> 320 × 112 <sup>3</sup>	31 sec.		86 min.		172 min.	

1 Use a CLASS  card or better. Individual movies can not exceed 29 minutes in length.

2 Individual movies can not exceed 120 minutes in length.

3 Use a CLASS  card or better. Individual movies can not exceed 30 seconds in length.



## System

<b>Focus range</b> (distance from front of lens)	Approx. 45 cm (1.4 ft.)–infinity (wide angle); 2.5 m (8.2 ft.)–infinity (telephoto) • <b>Macro:</b> approx. 5 cm–3.0 m/1.9 in.–9.8 ft. (wide angle); 1.3 m–3.0 m/4.2 ft.–9.8 ft. (telephoto)		
<b>Sensitivity</b>	Standard output sensitivity equivalent to ISO 100, 200, 400, 800, 1600, 3200, 6400 (image size <b>M</b> or <b>S</b> ), 12800 (image size <b>S</b> ); AUTO, AUTO (400), AUTO (800), AUTO (1600), AUTO (3200)		
<b>Metering</b>	256-segment through-the-lens (TTL) metering; MULTI, SPOT, AVERAGE		
<b>Exposure control</b>	Programmed AE; aperture-priority AE; shutter-priority AE; manual exposure		
<b>Exposure compensation</b>	–2 EV – +2 EV in increments of 1/3 EV		
<b>Picture stabilization</b>	Optical stabilization (image-sensor shift)		
<b>Shutter speed</b> (combined mechanical and electronic shutter)	8 s–1/2,000 s	• : 1/4 s–1/1,000 s	• : 3 s–1/1,000 s
	• <b>S</b> : 2 s–1/2,000 s	• <b>Other modes:</b> 1/4 s–1/2,000 s	• : 4 s–1/2 s
<b>Continuous</b>			
<b>F770EXR</b>	<ul style="list-style-type: none"> <li>• : Max. 200 frames; frame rate can be selected from 11, 8, 5, and 3 fps (The frame rate varies depending on the shooting conditions or numbers of frames in continuous shooting.)</li> <li>• : Max. 16 frames; frame rate can be selected from 11, 8, 5, and 3 fps</li> </ul>		
<b>F750EXR</b>	<ul style="list-style-type: none"> <li>• /: Max. 12 frames; frame rate can be selected from 12, 6, and 3 fps</li> </ul>		
<b>Focus</b>	<ul style="list-style-type: none"> <li>• <b>Mode:</b> Center AF, multi AF, continuous AF, tracking AF</li> <li>• <b>Autofocus system:</b> Contrast-detect TTL AF</li> </ul>		
<b>White balance</b>	Custom, auto, direct sunlight, shade, daylight fluorescent, warm white fluorescent, cool white fluorescent, incandescent, underwater		
<b>Self-timer</b>	Off, 2 sec., 10 sec.; auto shutter release ( and		

**System**

**Flash** Auto flash; effective range when sensitivity is set to **AUTO** is approx. 15 cm–3.7 m/0.4 ft.–12.1 ft. (wide angle; note that lens may block flash at short ranges), 90 cm–2.4 m/2.9 ft.–7.8 ft. (telephoto)

**Flash mode** Auto, fill flash, off, slow sync (red-eye removal off); auto with red-eye removal, fill flash with red-eye removal, off, slow sync with red-eye removal (red-eye removal on)

**LCD monitor** 3.0-in., 460k-dot color LCD monitor; frame coverage approx. 100%

**Movies**

- **FHD 1920**: 1,920 × 1,080 (1080p), 30 fps
- **FHD 1280**: 1,280 × 720 (720p), 30 fps
- **640**: 640 × 480 (VGA), 30 fps
- **FHD 640×480**: 80 fps
- **FHD 320×240**: 160 fps
- **FHD 320×112**: 320 fps

**Note:** **FHD**, **HD**, and **640** movies are recorded with stereo sound.

**Date map database was created** October 2010

**Input/output terminals**

**A/V OUT** (audio/video output) NTSC or PAL output with monaural sound

**Digital input/output** USB 2.0 High-Speed; shares A/V OUT connector; MTP/PTP

**HDMI output** HDMI mini connector

### Power supply/other

#### Power supply

- **F770EXR:** NP-50A rechargeable battery
- **F750EXR:** NP-50 rechargeable battery
- AC-5VX AC power adapter and CP-50 DC coupler (sold separately)

**Battery life** (approximate number of frames that can be taken with a fully-charged battery)

Battery type	Approximate number of frames
NP-50A/NP-50 (type supplied with camera)	300

CIPA standard, measured in  (auto) mode using battery supplied with camera and SD memory card.

**Note:** Number of shots that can be taken with battery varies with battery charge level and will decline at low temperatures.

#### Dimensions (W × H × D)

105.1 mm × 63.3 mm × 36.0 mm/4.1 in. × 2.4 in. × 1.4 in., excluding projections  
(minimum depth 24.9 mm/0.9 in.)

#### Shooting weight

- **F770EXR:** Approx. 234 g/8.2 oz., including battery and memory card
- **F750EXR:** Approx. 228 g/8.0 oz., including battery and memory card

#### Camera weight

- **F770EXR:** Approx. 213 g/7.5 oz., excluding battery, accessories, and memory card
- **F750EXR:** Approx. 209 g/7.3 oz., excluding battery, accessories, and memory card

#### Operating conditions

- **Temperature:** 0 °C – +40 °C/+32 °F – +104 °F
- **Humidity:** 10–80% (no condensation)



### ■ Notices

- Specifications subject to change without notice; for the latest information, visit [http://www.fujifilm.com/products/digital\\_cameras/index.html](http://www.fujifilm.com/products/digital_cameras/index.html). FUJIFILM shall not be held liable for damages resulting from errors in this manual.
- Although the LCD monitor is manufactured using advanced high-precision technology, small bright points and anomalous colors may appear, particularly in the vicinity of text. This is normal for this type of LCD monitor and does not indicate a malfunction; images recorded with the camera are unaffected.
- Digital cameras may malfunction when exposed to strong radio interference (e.g., electric fields, static electricity, or line noise).
- Due to the type of lens used, some distortion may occur at the periphery of images. This is normal.



# FUJIFILM

---

**FUJIFILM Corporation**

7-3, AKASAKA 9-CHOME, MINATO-KU, TOKYO 107-0052, JAPAN

[http://www.fujifilm.com/products/digital\\_cameras/index.html](http://www.fujifilm.com/products/digital_cameras/index.html)





# Restrictions on Camera Settings

Option	Shooting Mode																														
	EXR				Adv.						SP																				
	EXR	SR	SR	SR	SR	SR	SR	SR	M	A	S	P	04	05	06	07	08	09	10	11	12	13	14	15	16	17	18	19	20		
<b>HD</b>	HS 1920																													✓	
	HD 1280																														✓
	640																													✓	
	HS 640x480																													✓	
	HS 320x240																													✓	
	HS 320x112																													✓	
<b>SR</b>		✓	✓	✓					✓	✓	✓																				
<b>SR</b>	OFF	✓	✓	✓	✓	✓	✓	✓	✓	✓	✓	✓	✓	✓	✓	✓	✓	✓	✓	✓	✓	✓	✓	✓	✓	✓	✓	✓	✓	✓	
	1	✓	✓	✓	✓	✓	✓	✓	✓	✓	✓	✓	✓	✓	✓	✓	✓	✓	✓	✓	✓	✓	✓	✓	✓	✓	✓	✓	✓	✓	
	1		✓	✓	✓	✓	✓	✓	✓	✓	✓	✓	✓	✓	✓	✓	✓	✓	✓	✓	✓	✓	✓	✓	✓	✓	✓	✓	✓	✓	
	2	✓	✓	✓	✓	✓	✓	✓	✓	✓	✓	✓	✓	✓	✓	✓	✓	✓	✓	✓	✓	✓	✓	✓	✓	✓	✓	✓	✓	✓	
	2	✓	✓	✓	✓	✓	✓	✓	✓	✓	✓	✓	✓	✓	✓	✓	✓	✓	✓	✓	✓	✓	✓	✓	✓	✓	✓	✓	✓	✓	
<b>SR</b>	OFF		✓	✓	✓	✓	✓	✓	✓	✓	✓	✓	✓	✓	✓	✓	✓	✓	✓	✓	✓	✓	✓	✓	✓	✓	✓	✓	✓	✓	
	ON	✓	✓	✓	✓	✓	✓	✓	✓	✓	✓	✓	✓	✓	✓	✓	✓	✓	✓	✓	✓	✓	✓	✓	✓	✓	✓	✓	✓	✓	
<b>SR</b>	OFF	✓	✓	✓	✓	✓	✓	✓	✓	✓	✓	✓	✓	✓	✓	✓	✓	✓	✓	✓	✓	✓	✓	✓	✓	✓	✓	✓	✓	✓	
	ON	✓	✓	✓	✓	✓	✓	✓	✓	✓	✓	✓	✓	✓	✓	✓	✓	✓	✓	✓	✓	✓	✓	✓	✓	✓	✓	✓	✓	✓	
<b>SR</b>	OFF	✓	✓	✓	✓	✓	✓	✓	✓	✓	✓	✓	✓	✓	✓	✓	✓	✓	✓	✓	✓	✓	✓	✓	✓	✓	✓	✓	✓	✓	
	ON	✓	✓	✓	✓	✓	✓	✓	✓	✓	✓	✓	✓	✓	✓	✓	✓	✓	✓	✓	✓	✓	✓	✓	✓	✓	✓	✓	✓	✓	
<b>SR</b>	OFF	✓	✓	✓	✓	✓	✓	✓	✓	✓	✓	✓	✓	✓	✓	✓	✓	✓	✓	✓	✓	✓	✓	✓	✓	✓	✓	✓	✓	✓	
	ON	✓	✓	✓	✓	✓	✓	✓	✓	✓	✓	✓	✓	✓	✓	✓	✓	✓	✓	✓	✓	✓	✓	✓	✓	✓	✓	✓	✓	✓	
<b>SR</b>	OFF	✓	✓	✓	✓	✓	✓	✓	✓	✓	✓	✓	✓	✓	✓	✓	✓	✓	✓	✓	✓	✓	✓	✓	✓	✓	✓	✓	✓	✓	
	ON	✓	✓	✓	✓	✓	✓	✓	✓	✓	✓	✓	✓	✓	✓	✓	✓	✓	✓	✓	✓	✓	✓	✓	✓	✓	✓	✓	✓	✓	

1 Automatically optimized for selected shooting mode.

2 Image sizes over **S** are set to **S**.

3 Image sizes over **M** are set to **M**.

4 Aspect ratio fixed at 4:3.

5 Fixed at settings before recording a movie.