



s510

Digital Camera
User Manual

Table of Contents

| | |
|--|----|
| Preface | 3 |
| About this Manual | 3 |
| Safety and Handling Precautions..... | 3 |
| Using this Menu | 4 |
| Introduction | 5 |
| System Requirements | 5 |
| Main Features | 5 |
| Package Contents..... | 6 |
| Camera Views | 7 |
| Camera Buttons | 8 |
| Navigation Control..... | 9 |
| Camera Memory | 10 |
| Getting Started..... | 10 |
| Attach the Camera Strap..... | 10 |
| Inserting the Battery | 10 |
| Inserting an SD/SDHC/SDXC Memory Card..... | 11 |
| Charging the Battery by USB..... | 11 |
| Turning the Power On and Off | 12 |
| Initial Settings..... | 12 |
| Modes | 12 |
| Using the LCD monitor | 13 |
| LCD Monitor Layout | 13 |
| Recording Photos, Videos and Voices..... | 18 |
| Taking Photos | 18 |
| Setting the Zoom Control | 19 |
| Using Flash | 20 |
| Setting the Focus Mode | 20 |
| Setting Continuous Shooting | 21 |
| Using the Function Menu | 22 |
| Recording Videos..... | 26 |
| Using the Record Menu..... | 28 |
| Using Voice Recording | 35 |
| Playback | 42 |
| Viewing in Single Navigation..... | 42 |
| Viewing Thumbnails | 42 |
| Zooming photos | 43 |
| Playing Videos..... | 43 |
| Using Video Edit..... | 44 |
| Playing Video Recording..... | 45 |
| Playing Voice Memo..... | 45 |
| Deleting a Photo/Video/Audio..... | 46 |
| Playback Photos | 46 |
| Using the Setup Menu | 56 |
| Setting Sounds..... | 56 |
| Setting Power Save..... | 56 |

| | |
|--|----|
| Setting LCD Save..... | 57 |
| Setting Date & Time | 57 |
| Setting Language | 57 |
| Setting Display Mode | 57 |
| Setting File Numbering | 58 |
| Setting TV Out | 58 |
| Setting LCD Brightness | 58 |
| Setting Memory Kit | 59 |
| Reset All | 59 |
| Making Connections | 60 |
| Connecting the Camera to a PC | 60 |
| Connecting the Camera to a Printer | 61 |
| Setting the Print Mode Menu | 62 |
| Appendix..... | 63 |
| About Folder and File Names..... | 63 |
| Troubleshooting | 63 |
| Specifications | 64 |

Preface

About this Manual

- The contents of this manual and the bundled Basic Reference are subject to change without notice.
- Note that the example screens and product illustrations shown in this User's Guide may differ somewhat from the screens and configuration of the actual camera.

Copyright

- This manual contains proprietary information protected by copyright. All rights are reserved. No part of this manual may be reproduced by any mechanical, electronic or other means, in any form, without prior written permission of the manufacturer.
- HP shall not be liable for technical or editorial errors or omissions contained herein.
© Copyright 2012

Federal Communications Commission (FCC) Compliance

This equipment has been tested and found to comply with the limits for a Class B digital device, pursuant to Part 15 of the FCC Rules. These limits are designed to provide reasonable protection against harmful interference in a residential installation. This equipment generates, uses, and can radiate radio frequency energy and, if not installed and used in accordance with the instructions, may cause harmful interference to radio communications. However, there is no guarantee that interference will not occur in a particular installation. If this equipment does cause harmful interference to radio or television reception, which can be determined by turning the equipment off and on, the user is encouraged to try to correct the interference by one or more of the following measures:

- Reorient or relocate the receiving antenna.
- Increase the distance between the equipment and the receiver.
- Connect the equipment to an outlet on a circuit different from that to which the receiver is connected.
- Consult the dealer or an experienced radio/TV technician for help.

Warning: A shielded-type power cord is required in order to meet FCC emission limits and to prevent interference to radio and television reception. Use only shielded cable to connect I/O devices to this equipment. Any changes or modifications not expressly approved by the manufacturer may void your warranty and service agreement.

Declaration of Conformity

This device complies with Part 15 of the FCC rules. Operation is subject to the following conditions:

- This device may not cause harmful interference.
- This device must accept any interference received, including interference that may cause undesired operation.

Trademark Recognition

Window 2000/XP/Vista/7 are registered trademarks of Microsoft Corporation in the United States and/or other countries. Windows is an abbreviated term referring to the Microsoft Windows Operation System. All other companies or product names are trademarks or registered trademarks of their respective companies.

Safety and Handling Precautions

Camera Information



- Do not take apart or attempt to service the camera yourself.
- Do not expose the camera to moisture, or extreme temperatures.
- Allow the camera to warm up when moving from cold to warm temperatures.
- Do not touch the camera lens.
- Do not expose the lens to direct sunlight for extended periods.
- Do not use abrasive chemicals, cleaning solvents or strong detergents to clean the product. Wipe the product with a slightly damp soft cloth.
- Do not use the flash or LED Light near a person's eyes to prevent possible eye injury.
- To prevent you from falling over or resulting in traffic accident, please do not use the camera while you are walking, driving or riding a vehicle.
- Please handle the camera strap with care, and never place the strap around the neck of an infant or child. Wrapping the strap around a neck may cause suffocation.
- Do not subject the LCD monitor to impact.
- To prevent the risk of fire or electric shock, do not expose this appliance to rain or moisture.

Battery Information

- Power off the camera before installing or removing the battery.
- Use only the provided battery or type of battery and charger that came with your camera. Using other types of battery or charger may damage the equipment and invalidate the warranty.
- When using Li-ion battery in this product, ensure that they are inserted correctly. Inserting the battery incorrectly can cause damage to the product and in rare occasions possibly cause an explosion.
- When the camera is used for an extended period of time, it is normal for the camera body to feel warm.
- Download all pictures and remove the battery from the camera if you are going to store the camera for a long period of time.
- The type of battery and the battery power level may cause the lens to extend or retract properly. Ensure you use the correct battery type and use a fully charged battery.
- Risk of explosion if battery is replaced by an incorrect type. Dispose of used batteries according to the instructions.
- Please keep the batteries out of the reach of children to prevent from swallowing batteries, which might cause poisoning.

Using this Menu

Symbols used in this manual are explained below:

| | |
|--|---|
|  | This indicates useful information when using your camera. |
|  | This indicates important message that should be read before using the function. |

Introduction

Congratulations on your purchase of the new HP digital camera.
Capturing high-quality digital photos is fast and easy with this state-of-the-art smart camera.

System Requirements

In order to get the most out of your camera, your computer must meet the following system requirements:

For Windows:

- Windows XP/Vista/Win7
- Processor: Pentium D 3.0GHz or above
- Memory: 1GB RAM (2G is recommended)
- HDD space: 300MB or above (10GB is recommend)
- 32bit color display monitor
- Microsoft DirectX 9.0C
- USB port and CD-ROM drive

For Macintosh:

- Power Mac G3 or later
- Mac OS 10.3X ~ 10.6 <Mass storage> or later
- Memory: 1GB or above
- USB port and CD-ROM drive

Main Features

- 16 megapixels resolution
- Up to 5X optical zoom and 5x digital zoom
- 2.7 inch color LCD monitor
- 64 MB internal flash memory with optional external SD/SDHC/SDXC card
- Supports up to 4GB of SD card, and up to 32GB of SDHC card and to 64GB of SDXC card
- Easy-to-use button interface
- DCF, DPOF, PictBridge compatibility
- Slideshow to review still images
- A/V output to view your images, videos and audio on your TV
- USB port to transfer images, videos and audio to your computer

Package Contents

Please check the contents of your camera package. It should contain:

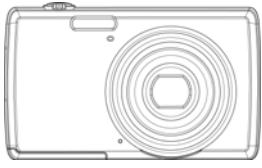

Digital camera

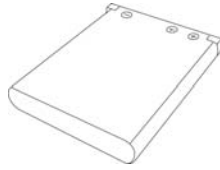

Rechargeable battery x 1 pcs



USB cable



Wrist strap

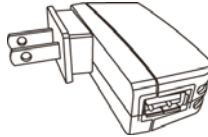

USB adapter
(The type of plug may vary depending on the country or region)

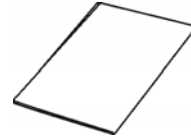

Quick Start Guide

Camera Views

Front View

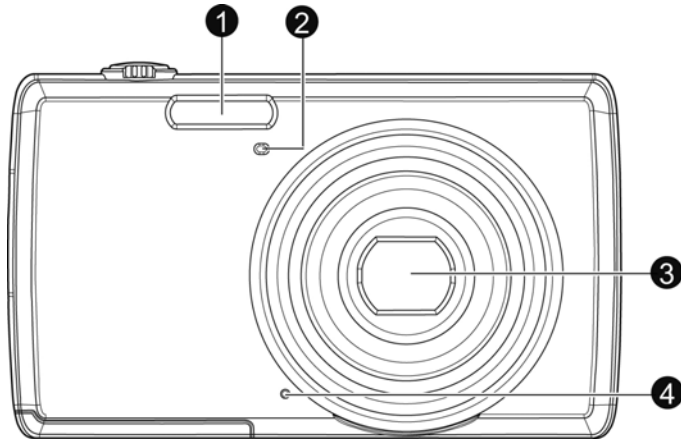

- 1. Flash
- 2. Self-timer LED
- 3. Lens
- 4. Microphone

Back View

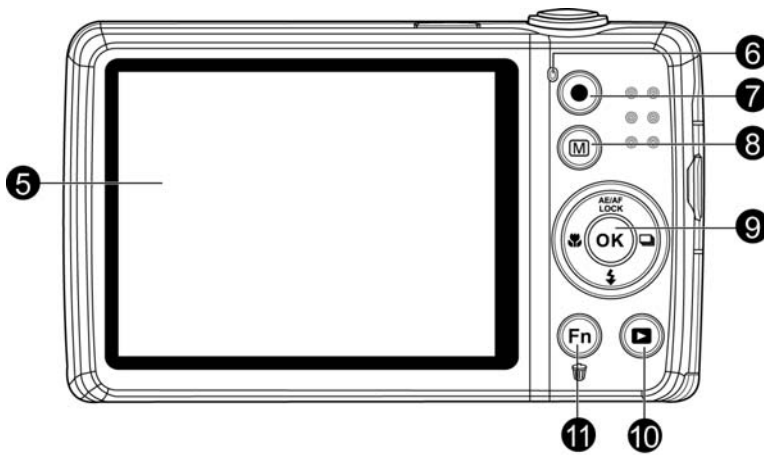

- 5. LCD monitor
- 6. LED indicator
- 7. Video Record button
- 8. Menu button
- 9. OK button/4-way navigation control
- 10. Playback button
- 11. Fn/Delete button

Top View

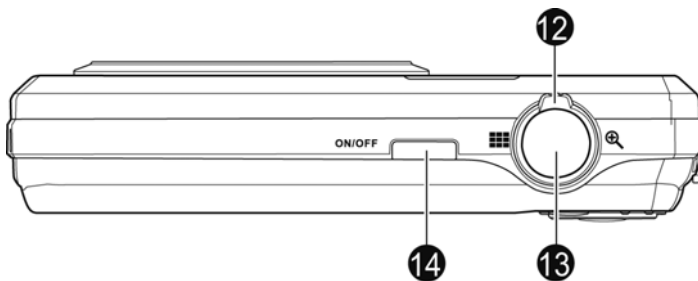

- 12. Zoom dial
- 13. Shutter button
- 14. Power button

Bottom View

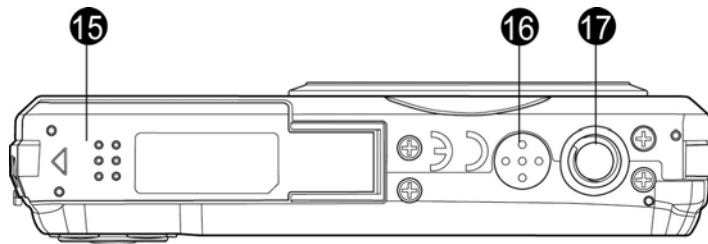

- 15. Battery/Memory card compartment

- 16. Speaker

- 17. Tripod screw hole

Left/Right View

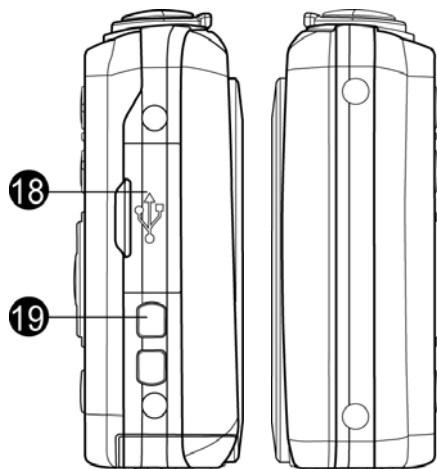

- 18. USB/TV Out

- 19. Strap ring

Camera Buttons

Your camera is equipped with different buttons for ease of use.

| Button | Description |
|--------------|--|
| Power | Press the Power button to turn the power on/off. |
| Shutter | Press to capture an image or start/stop recording audio clip. |
| Zoom dial | In photo and movie mode, spin the zoom dial to left to zoom out, right to zoom in. In Playback mode, spin to zoom in to magnify image or zoom out enter 9-image/calendar thumbnails. |
| Menu | Press to enter or exit menu/submenu. |
| Fn/Delete | In Photo and Movie mode, press to enter function menu. In Playback mode, press to delete an image, video or audio clip. |
| Playback | Press to enable Playback mode or return Record mode. |
| Video Record | Press to start/stop recording video. |

Navigation Control

The **4-way Navigation Control** and the **OK** button allow you to access the various menus available from the On Screen Display (OSD). You can configure a wide range of settings to ensure maximum results from your images and videos. Further functions of these buttons are as follows:

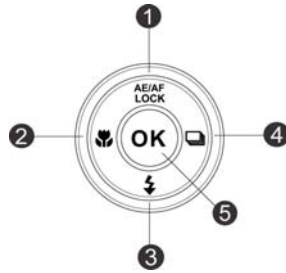

| No. | Description |
|-----|---------------------------------------|
| 1 | AE/AF LOCK (Auto Exposure/Auto Focus) |
| 2 | Macro Button |
| 3 | Flash Button |
| 4 | Continuous Shooting Button |
| 5 | OK Button |

| Button | Description |
|---------------------------|---|
| AE/AF LOCK/Up | <ol style="list-style-type: none"> To lock AE/AF, press and hold the AE/AF LOCK/Up button for 1 second, or half press the shutter button then press the AE/AF LOCK/Up button in Photo Mode. To unlock AE/AF by any one of the following ways: <ul style="list-style-type: none"> Press the AE/AF LOCK/Up button Rotate the zoom control Press the MENU/Fn/Playback/Movie/Power button to launch another function In Menu, press to navigate through the menu and submenu selections. |
| Macro/Left | <ol style="list-style-type: none"> In Photo Mode, press to scroll through Macro options. (Auto Focus, Super Macro, Pan Focus, Infinity and Manual Focus) In Playback mode, press to view the previous image, video or audio clip. In Playback movie mode, press to rewind video playback. In Menu, press to exit a submenu or to navigate through the menu selections. |
| Flash/Down | <ol style="list-style-type: none"> In Photo Mode, press to scroll through the flash mode options. (Auto, Red-eye Reduction, Forced On, Slow Sync and Forced Off) In Menu, press to navigate through the menu and submenu selections. |
| Continuous Shooting/Right | <ol style="list-style-type: none"> Press to scroll through Continuous Shooting options. (Off, Burst, Speedy Burst and AEB) In Playback mode, press to view the next image, video or audio clip. In playback Movie mode, press to forward video playback. In Menu, press to enter the submenu or to navigate through the menu selections. |
| OK | <ol style="list-style-type: none"> Confirm a selection when using the OSD menus. In Playback Movie/Audio mode, press to start video or audio playback. |

Camera Memory

Internal memory

Your camera is equipped with 64MB of internal memory. Users can store files up to 37MB. If there is no memory card inserted in the memory card slot, all photos, videos and audio clips recorded are automatically stored in the internal memory.

External storage

Your camera supports SD cards of up to 4GB in size. It also supports SDHC cards with a maximum capacity of 32GB. Then also supports SDXC cards with a maximum capacity of 64GB. If there is a storage card inserted in the memory slot, the camera automatically saves all photos, videos and audio clips in the external storage card. The icon  indicates the camera is using SD card.



Not all cards may be compatible with your camera. When purchasing a card, please check the card's specifications and take the camera with you.

Getting Started

Attach the Camera Strap

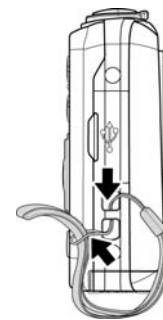

Inserting the Battery

Follow these instructions to insert the rechargeable battery into the battery/memory card compartment. Please read "Battery Information" on page 4 before inserting/removing the battery.

1. Make sure the power is off before inserting the battery.
2. Unlock and open the battery/memory card compartment at the bottom of the camera.
3. Insert the battery into the compartment with the terminal facing inside the camera with correct orientation as shown.

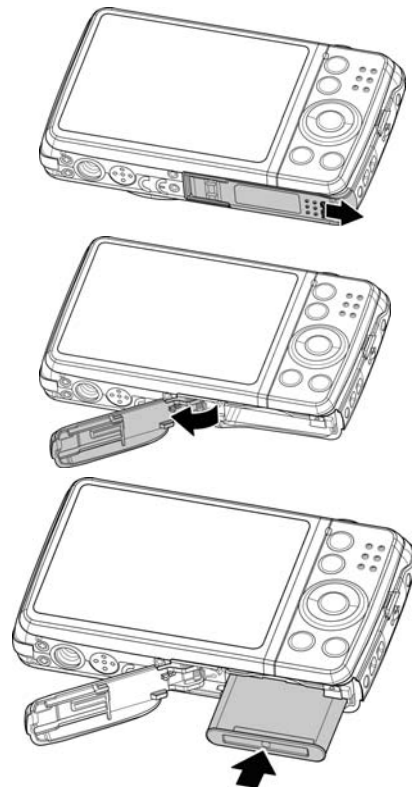

4. Close and lock the battery/memory card compartment.

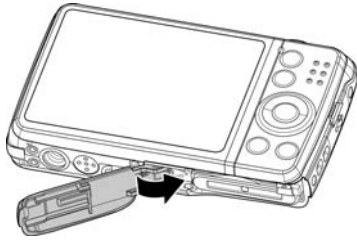

Inserting an SD/SDHC/SDXC Memory Card

Expand your camera's storage by using SD, SDHC or SDXC memory cards.

1. Unlock and open the Battery/memory card compartment at the bottom of the camera.
2. Insert the SD/SDHC/SDXC card into the memory card slot with the metallic part facing the back side of the camera.
3. Push the SD/SDHC/SDXC card into the memory slot until it clicks into place.
4. Close and lock the Battery/memory card compartment.

To remove the SD/SDHC/SDXC card

1. Unlock and open the battery/memory card compartment.
2. Gently push the card until it pops out.
3. Pull out the card carefully.

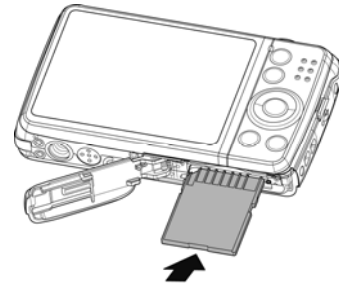
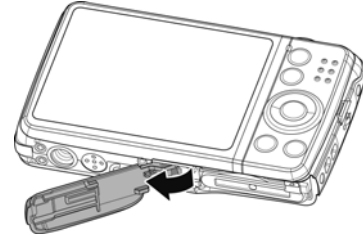

Windows 2000/XP are not support SDXC card (exFAT format). But in Windows XP (Service Pack 2 or 3 do), you can download exFAT patch update to support SDXC card.

Charging the Battery by USB

In other way charging the battery, you can use the USB cable to connect the camera with PC or USB adapter.

1. Connect the camera with the USB cable as shown.
2. Connect the other end with the USB adapter and plug it into a power outlet or with the USB port of PC directly for charging.
 - When the battery is charging, the LED indicator flashes.
 - When the battery is fully charged, the LED indicator turns off.
 - If the battery is defective or unable to charge properly, the LED indicator flashes rapidly.
 - When the camera charges without the battery inside, the LED indicator turns off.

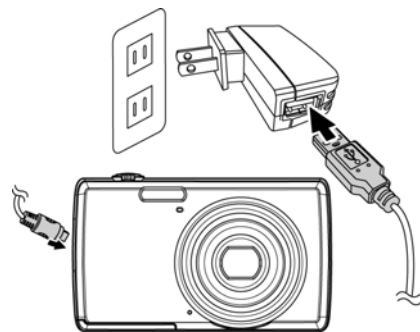

- It's recommended not to operate the camera when charging.
Actual charging time depends on current battery capacity and charging conditions.

Turning the Power On and Off

There are two ways to power on the camera:

- Press the Power button, and the startup image displays briefly and the startup sound plays if enabled. The lens will extend and the camera is ready to take photos or record video.
- Press the Playback button, and the camera is in Playback mode. The zoom lens is not extended.

To power off the camera, press the **Power button**.

Initial Settings

When you power on your camera for the first time, you will be asked to do the initial settings of your camera. First is the setup of language menu. Specify in which language menus and messages are to be displayed on the LCD monitor.

Setting the Language

1. Use the 4-way navigation control to move through the selections.
2. Select a language, and then press **OK** to apply.

Setting the Date & Time

1. Use the 4-way navigation control to move through the selections.
2. Press Up/Down key on the navigation control to change the value for the date and time.
3. Press **OK** to apply.

4. If necessary, press  to close the menu.

Now, you are ready to start taking photos and videos.



Holding down Up/Down key on the navigation control to change the values continuously.

Modes

Your camera has three modes:

Record Mode

This is the default mode while you power on the camera every time. You are able to take photos and record audio clips in this mode.

Playback mode

Press the **Playback button**  after the camera is turned on to view and edit captured photos or playback videos and audio clips. The recording of voice memo attached to images is available in this mode.

Video Record mode

Press the **Video Record button**  after the camera is start/stop recording video in this mode.

Using the LCD monitor

The LCD monitor shows all important information regarding camera settings as well as the visual image of your photo or video. The display on the LCD monitor is called the On Screen Display or OSD.

LCD Monitor Layout

Photo Mode Screen Layout

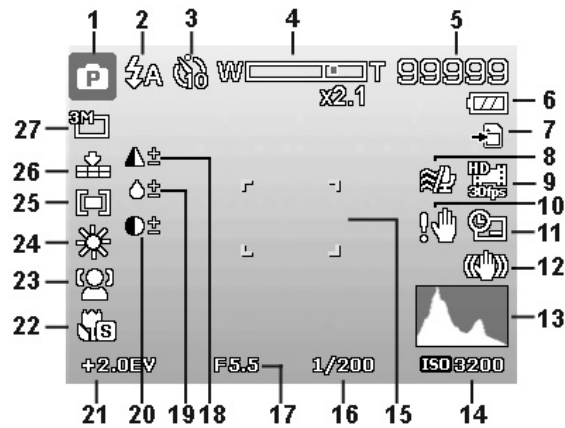

| No. | Item | Description |
|-----|------------------|--|
| 1 | Record Mode | Indicates the current mode. |
| 2 | Flash | Indicates flash settings. |
| 3 | Self-timer/Burst | Indicates drive mode settings. |
| 4 | Zoom indicator | Displays zoom. |
| 5 | Shots remaining | Indicates the remaining shots available. |
| 6 | Battery | Indicates estimated battery level. |
| 7 | Storage media | Indicates current storage media in use. |
| 8 | Wind Cut | Reduces wind noise during movie recording. |
| 9 | Video resolution | Indicates Video resolution. |
| 10 | Shake warning | Indicates the current lighting is not enough and the camera is shaking, which may cause the captured photo to be blurred. If the shake warning appears, you can still capture photos. However, enabling the Stabilizer in the setup menu or using a tripod may reduce the blurring of your photos. |
| 11 | Date stamp | Indicates date stamp is enabled. |
| 12 | Stabilizer | Indicates stabilizer function is enabled. |
| 13 | Histogram | Graphic display of Brightness. |
| 14 | ISO | Displays ISO settings. |
| 15 | Focus area | Indicates focus area. |
| 16 | Shutter speed | Displays shutter speed settings. |
| 17 | Aperture value | Displays aperture settings. |
| 18 | Sharpness | Displays sharpness settings. |
| 19 | Saturation | Displays saturation settings. |
| 20 | Contrast | Displays contrast settings. |
| 21 | Exposure | Displays exposure settings. |
| 22 | Focus | Indicates focus is enabled. |
| 23 | Face tracking | Indicates face tracking is enabled. |
| 24 | White balance | Displays white balance settings. |
| 25 | Metering | Displays metering settings. |
| 26 | Quality | Displays quality settings. |
| 27 | Photo size | Displays photo size settings. |

Video Record Mode Screen Layout



| No. | Item | Description |
|-----|------------------|--|
| 1 | Key indicator | Displays the commands on 4-way Navigation Control button |
| 2 | Recorded time | Displays recorded time. |
| 3 | Recording status | Indicates recording status. |

Playback Mode Screen Layout

The Playback mode display varies depending on the type of image being viewed.

Playback mode display of still images:

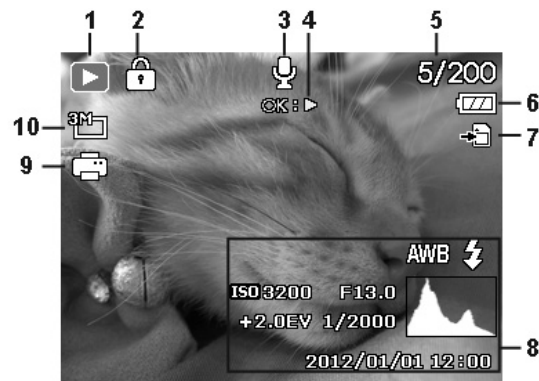

| No. | Item | Description |
|-----|-----------------------|---|
| 1 | Playback mode | Indicates playback mode. |
| 2 | Protect | Indicates file is protected. |
| 3 | Voice memo | Indicates voice memo is attached. |
| 4 | Button intro | Indicates the button to press on the camera to play a video or audio file. |
| 5 | File no./Total no. | Indicates the file number over the total number of files in the storage card. |
| 6 | Battery | Indicates estimated battery level. |
| 7 | Storage media | Indicates used storage memory. |
| 8 | Recording information | Displays recording information of the file. |
| 9 | DPOF | Indicates the file is marked for printing. |
| 10 | Image Size | Displays the image size settings. |

Playback mode of videos:

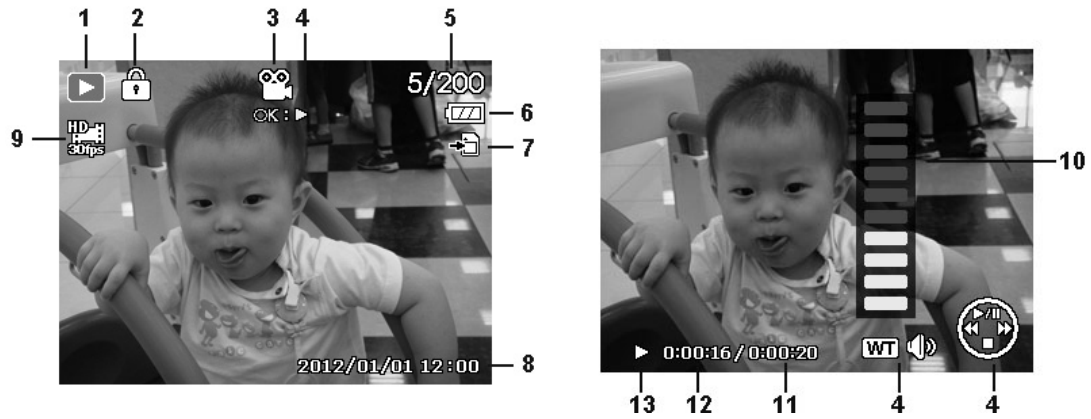

| No. | Item | Description |
|-----|-----------------------|---|
| 1 | Playback mode | Indicates playback mode. |
| 2 | Protect | Indicates file is protected. |
| 3 | Video clip | Indicates the file is a video. |
| 4 | Button intro | Indicates the button to press on the camera to play a video or audio file. |
| 5 | File no./Total no. | Indicates the file number over the total number of files in the storage card. |
| 6 | Battery | Indicates estimated battery level. |
| 7 | Storage media | Indicates used storage memory. |
| 8 | Recording date & time | Displays the date and time of the video clip. |
| 9 | Video size | Indicates the size of the video clip. |
| 10 | Volume | Indicates the volume while playing. |
| 11 | Video length | Display the total length of the video clip. |
| 12 | Played time | Indicates the played time of the video. |
| 13 | Playing status | Displays playing status. |

Playback mode of audio clips:

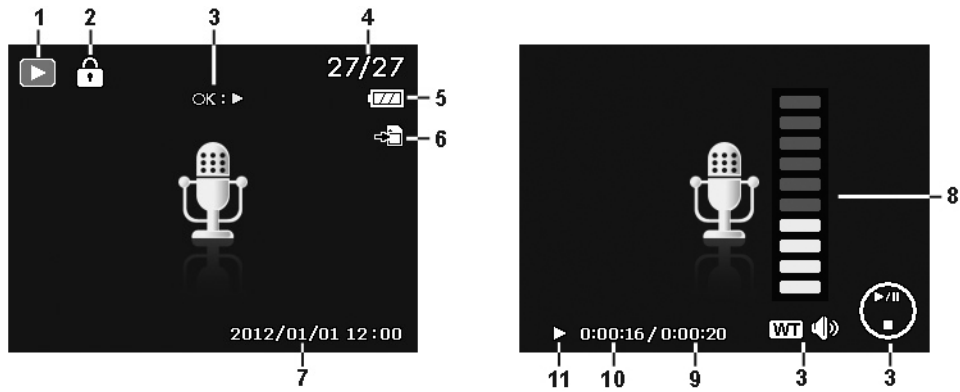

| No. | Item | Description |
|-----|-----------------------|---|
| 1 | Playback mode | Indicates playback mode. |
| 2 | Protect | Indicates file is protected. |
| 3 | Button intro | Indicates the button to press on the camera to play a video or audio file. |
| 4 | File no./Total no. | Indicates the file number over the total number of files in the storage card. |
| 5 | Battery | Indicates estimated battery level. |
| 6 | Storage media | Indicates used storage memory. |
| 7 | Recording information | Displays recording information of the file. |
| 8 | Volume | Indicates volume settings. |
| 9 | Audio length | Display the total length of the audio clip. |
| 10 | Played time | Indicates played time. |
| 11 | Playing status | Displays playing status. |

Recording Photos, Videos and Voices

Taking Photos

Now that you are familiar with your camera, you are now ready to take your photos. Taking photos with your camera is very simple.

1. Power on the camera by pressing the **Power button**.
2. Frame the shot using the focus bracket on the LCD monitor. See illustration on the right.
3. Pressing the **Shutter button** down halfway automatically focuses and adjusts the exposure, and pressing the **Shutter button** down fully captures the photos.

When the shake warning icon  appears, hold the camera steadily, with your arms at your side or use a tripod to stabilize the camera to reduce blurred images.

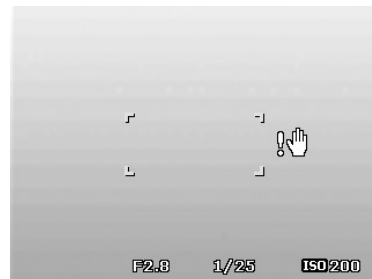
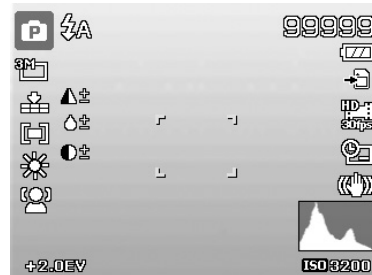



Setting the Zoom Control

Using a combination of 5 times optical zoom and 5 times digital zoom permits zoom photography at up to 25 times magnification. While the digital zoom can be a useful feature, the more an image is enlarged (zoomed), the more pixelated (grainier) the image will appear. Please refer to "Setting the Digital Zoom" on page 39 on how to setup digital zoom.

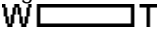
To adjust the optical zoom:

1. Spin the **Zoom dial** to zoom in or zoom out an image.
2. The zoom indicator appears on the LCD monitor. 

Zoom dial

1. Spin the dial clockwise (right) to zoom in. 
2. Spin the dial counterclockwise (left) to zoom out. 

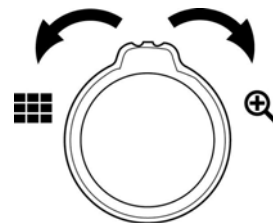

To adjust the digital zoom:

1. Activate digital zoom. See "Setting the Digital Zoom" on page 39.
2. Spin the **Zoom dial** clockwise/counterclockwise optically zooms in/out to the maximum until it stops.
3. Release the **Zoom dial**.

Optical zoom 1X to 5X

Digital zoom 1x to 5x



Digital zoom is not activated in recording videos

Using Flash

When taking pictures in difficult lighting conditions, use the **Flash/Down** button to get correct exposure. This function cannot be activated in recording videos or continuous shooting.

To activate Flash:

- Press the **Flash/Down** button on your camera repeatedly until your desired flash mode is displayed on the LCD monitor.



Flash/Down button

Your camera is equipped with five flash modes:

⚡A Auto Flash. The flash fires automatically whenever extra lighting is needed.

⚡👁 Red-eye reduction. The flash fires twice to reduce the red-eye effect.

⚡ Forced on. The flash fires whenever you press the Shutter button regardless of lighting conditions.

⚡SL Slow sync. The flash fires with a slow shutter speed.

⚡/ Forced off. The flash is turned off.



- Flash function is only available in shooting photos but not available in Burst and AEB modes.



Setting the Focus Mode

This function allows users to define the type focus when recording a photo or a video clip.

To set the Focus mode

- Press the **Macro/Left** button repeatedly until the desired focus mode icon is displayed on the lower left corner of the LCD monitor.

Macro/Left button

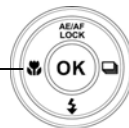

Your camera supports the five focus modes:

AF Auto Focus. With AF, the camera will focus on the subject automatically.

👁S Super Macro. This mode is designed for close-up photography. When Super Macro is set, the focus cannot be adjusted until Super Macro is canceled.

PF Pan Focus. The focus of this mode is in the maximum Depth of Field (DOF), not designing for close-up photography.

∞ Infinity. When Infinity is set, the camera focuses on distant objects.

MF Manual Focus. With manual focus, you can adjust the focus distance from 30cm to 100cm by press Up/Down button. Press OK button to lock the focus and exit the adjusting screen.



Setting Continuous Shooting

This function allows users to set the continuous shooting mode. It's only available in shooting photos. Press Right button to launch the Continuous Shooting menu options, and then press Left/Right button to select the desired option.

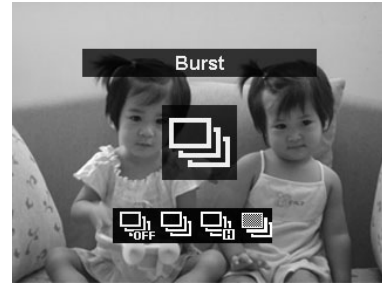

| Icon | Item | Description |
|------|--------------|--|
| | Off | Disable the continuous shooting function. |
| | Burst | Full press and hold the shutter button to take a continuous shooting until release the shutter button or memory card is full. |
| | Speedy Burst | Captures 30 images in a shot when the Shutter button is pressed. Auto set Image size to 4:3 VGA only. |
| | AEB | Full press the shutter button to bracketing takes 3 continuous photos with 1/3 EV in the following order: Standard exposure, underexposure and overexposure. |

Using the Function Menu

Press the **Fn/Delete**  button in Record mode (except Voice Recording) will bring up the Function Menu with most common features for photos and videos.



Press the **Fn/Delete** button of your camera to launch the Function Menu.
Press the **Fn/Delete** button again to close the menu.

- The Menu bar displays the current status of your camera settings. Only the available functions for the settings are shown as icon on the menu bar.
- The available options for each item on the menu bar are shown in the Menu options.
- Use the 4-way navigation control to move through the menu selections then press the **OK** button to save and apply changes.
- Press **Menu** button or **Fn/Delete** button to cancel selecting and close Function Menu.

Menu bar

Menu Options

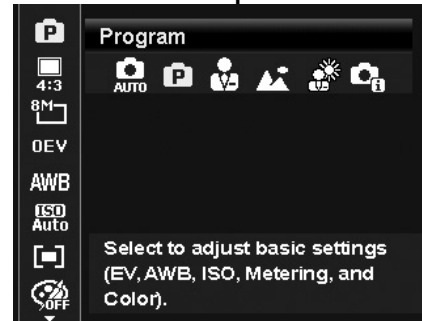

My Mode

1. The My Mode function displays the **5** most recent modes used in order. When you move through the different modes in the menu options, the items on the menu bar changes synchronously to the corresponding available settings.
2. **Auto mode** is fixed in the first of Menu options.

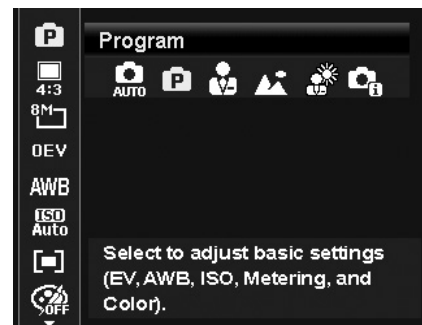

Aspect Ratio

The Aspect Ratio function is used to set the width to height ratio of a photo. Display available remaining shots in help text synchronously while selecting different options.

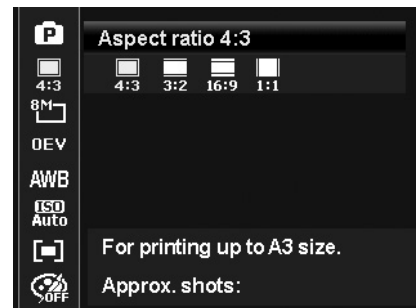
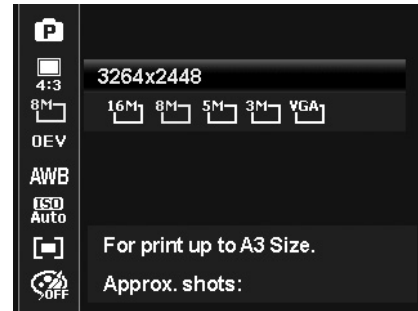

Photo Size

The Photo Size function is used to set the resolution before you capture the photo. Changing the Photo Size affects the number of photos that can be stored in your memory card. The higher the resolution, the more memory space is required.



The table below shows the Photo Size values for photos when selecting **Aspect ratio 4:3**.

| Icon | Pixel Size | Printing Size Suggestion |
|------|-------------|--------------------------|
| | 4608 x 3456 | A2 Size |
| | 3264 x 2448 | A3 Size |
| | 2560 x 1920 | A4 Size |
| | 2048 x 1536 | A5 size |
| | 640 x 480 | E-mail |

The table below shows the Photo Size values for photos when selecting **Aspect ratio 3:2**.

| Icon | Pixel Size | Printing Size Suggestion |
|------|-------------|--------------------------|
| | 4608 x 3072 | 8" x 12" |
| | 3264 x 2176 | 6" x 9" |
| | 2560 x 1696 | 5" x 7" |
| | 2048 x 1360 | 4" x 6" |
| | 640 x 424 | E-mail |

The table below shows the Photo Size values for photos when selecting **Aspect ratio 16:9**.

| Icon | Pixel Size | Printing Size Suggestion |
|------|-------------|--------------------------|
| | 4608 x 2592 | HDTV |
| | 3264 x 1832 | HDTV |
| | 2560 x 1440 | HDTV |
| | 2048 x 1152 | HDTV |
| | 640 x 360 | E-mail |

The table below shows the Photo Size values for photos when selecting **Aspect ratio 1:1**.

| Icon | Pixel Size | Printing Size Suggestion |
|------|-------------|--------------------------|
| | 4000 x 4000 | Square Composition |
| | 2832 x 2832 | Square Composition |
| | 2240 x 2240 | Square Composition |
| | 1728 x 1728 | Square Composition |
| | 480 x 480 | E-mail |

EV Compensation

Photos can be captured with the overall scene intentionally made brighter or darker. These settings are used when a suitable brightness (exposure) cannot otherwise be obtained in circumstances where the difference in brightness between the subject and the background (the contrast) is large, or when the subject that you wish to capture is very small within the scene. Available for still images only.

- To adjust EV settings, press the 4-way navigation control to increase/decrease the value. As you adjust the settings, the LCD monitor synchronously displays the image applying the EV settings. Press the **OK** button to save and apply changes.



White Balance

This sets the white balance for a variety of lighting conditions and permits images to be captured that approach the conditions that are seen by the human eye.

- As you move through the selection, you can see the preview on the LCD monitor synchronously.

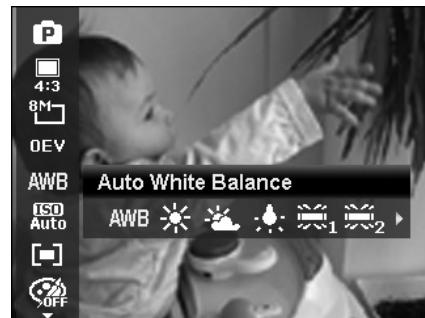

| Icon | Item | Description |
|------|--------------------|---|
| | Auto White Balance | The camera automatically adjusts the white balance. |
| | Daylight | Ideally used for bright sunny conditions. |
| | Cloudy | Ideally used for cloudy conditions. |
| | Tungsten | Ideally used for indoor photos with tungsten or halogen lighting without a flash. |
| | Fluorescent 1 | Ideally used for indoor photos with bluish fluorescent lighting conditions. |
| | Fluorescent 2 | Ideally used for indoor photos with reddish fluorescent lighting conditions. |
| | Custom | Used when light source cannot be specified. Press the Shutter button for the camera to automatically adjust the appropriate white balance setting according to the environment. |

ISO

This sets the sensitivity for capturing photos. When the sensitivity is raised (and the ISO figure is increased), photography will become possible even in dark locations, but the more pixelated (grainier) the photo will appear.

- Use a higher ISO setting in dim conditions and a lower ISO setting in brighter conditions.

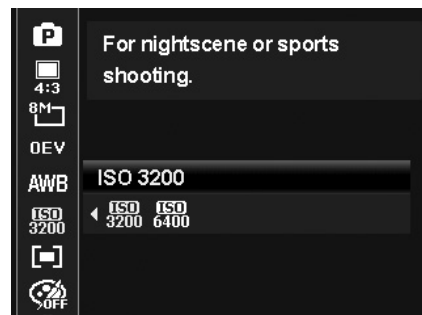

Metering

This sets the metering method for calculating the exposure.

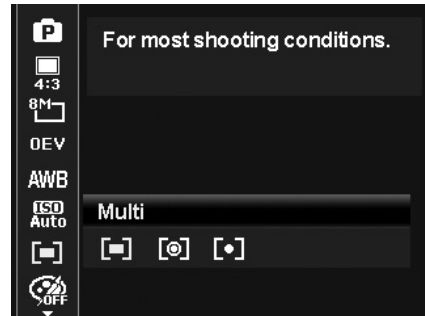

| Icon | Item | Description |
|------|--------|---|
| | Multi | The entire area of the screen is measured, and the exposure is calculated. |
| | Center | Averages the light metered from the entire frame, but gives greater weight to the subject matter at the center. |
| | Spot | A very small portion of the center of the screen is measured, and the exposure is calculated. |

Color Mode

The Color Mode function applies different colors or tones for a more artistic effect on the photos or videos.

- As you move through the selection, the preview on the LCD monitor changes synchronously.



| Icon | Item | Description |
|------|----------------------|---|
| | Off | The camera records normally. |
| | Vivid | The camera captures the photo with more contrast and saturation emphasizing on the bold colors. |
| | Sepia | Photos are captured in sepia tones. |
| | Color Accent (Red) | Retains red tone while the rest of the scene becomes black and white. |
| | Color Accent (Green) | Retains green tone while the rest of the scene becomes black and white. |
| | Color Accent (Blue) | Retains blue tone while the rest of the scene becomes black and white. |
| | B&W | Photos are captured in black and white. |
| | Vivid Red | Captured photo becomes reddish. Ideally used to take photos of flowers and cars to make them more vivid. |
| | Vivid Green | Captured photo becomes greenish. Ideally used to take photos of mountains and lawns to make them more vivid. |
| | Vivid Blue | Captured photo becomes bluish. Ideally used to take photos of the sky and the ocean to make them look more vivid. |

Art Effect

This function applies different art effect on the photos or videos. When you select options by pressing the left or right side of the 4-way navigation control, the preview result will show on the LCD monitor.

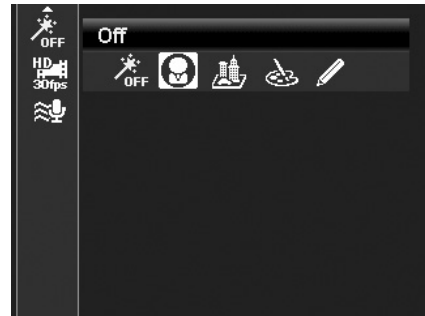

| Icon | Item | Description |
|------|------------------|--|
| | Off | Disable the art effect function. |
| | Fisheye Lens | This feature captures images with fisheye lens effects. |
| | Miniature Effect | Blur the parts of photo to make the scene looks like a miniature scale model. It is recommended to capture from a high angle to simulate the miniature effect. |
| | Painting | This feature captures photos with painting effects. |
| | Sketch | This feature captures photos with sketch effects. |

Recording Videos

You can record videos with the camera, the available recording time depends on the capacity of the memory card and the video resolution. Videos can be recorded until the maximum memory capacity has been reached. However the length of a single video may be limited (the limitation depends on the camera model).



1. Press the **Video Record button** to start recording.
2. Focus your camera on the subject that you want to take.
3. Use the **Zoom dial** to zoom in and zoom out an image.
4. To pause recording, press Up on the navigation control.
5. To continue recording, press Up on the navigation control again.
6. To stop recording, press the **Video Record button**.



- When the camera stop recording due to reaching maximum capacity (**4GB**) for a single video, simply press again to continue recording.
- The camera will automatically stop recording when the memory capacity is full.
- Digital zoom is not available while recording a video.
- Sound will not be recorded when zooming in or out.
- Power save mode is not available in video recording or pause recording.

Photo In Video (PIV) function

While recording a video, you can capture photos by full pressing the shutter button without stopping the video recording.

Once a photo is captured, an icon and the number of shots will be kept on screen. If it reaches the maximum number of shots, the icon and number are turned into red, but the video recording is still continuing.

The PIV feature only applicable to video size: 720p30 and VgAp30.



- When the video size is 720p (30fps), the capture photos are saved at 1280x720 resolution.
- When the video size is VGA (30fps), the capture photos are saved at 640x480 resolution.

Settings of Recording Videos



Press **Fn/Delete button** to enable video setting menu before recording a video.

Video Resolution Size

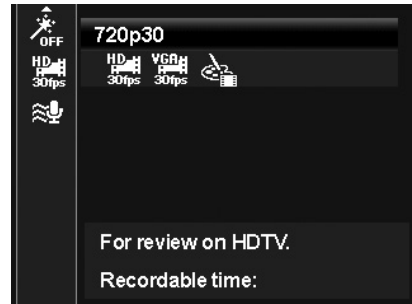
The Video Resolution Size function appears only in Video Resolution mode. Use this function to adjust the resolution and quality of movie clips.



The table below shows the available size and corresponding image quality settings.

| Icon | Item | Description |
|---|-------------------|---|
|  | 720p30 | For watching in HDTV. * |
|  | VGAp30 | Better video quality. |
|  | 720p30 (Painting) | Recording video with painting effect. * |



- The options with "*" are only available when a SDHC class4 or class6 card is inserted. Gray the options and disallow the cursor move on them if disabled.
- The Continuous AF feature would be fixed at "On" and can't be changed if set 720p30 (Painting).
- The camera will automatically stop recording when the recording time is over 29 minutes or the file size is over 4 GB.

Setting Wind Cut

This feature reduces wind noise during video recording.



Using the Record Menu

If you are in Photo Mode, you can access the Record menu simply by pressing the **MENU button** on your camera.

When the menu is displayed, use the 4-way navigation control and the **OK button** to move through menu selections and apply your desired settings. To close the menu anytime, press the menu button again.

Record Menu

The Record menu allows you to change modes, and setup other capture settings.

To go to Record Menu:

Turn on the camera by pressing **Power button**.

1. Press  to launch the Record Menu.
2. Use The **4-way Navigation Control** to move through the menu
3. To select an item, press **OK button**.
4. Change the submenu settings using the 4-way navigation control.
5. Press the **OK button** to save and apply settings.







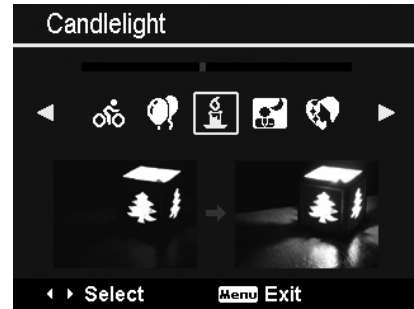

Setting the Scene Mode

















By simply selecting one of the following 30 modes, you can capture the photo or record the audio with the most appropriate settings.





1. From the Record Menu, press to select **Scene Mode**.
2. Use the navigation controls to move through the selection.
3. Press the **OK button** to save and activate the selected scene mode.



The table below shows the available scene mode settings.

| Icon | Item | Description |
|---|-------------------|--|
|  | Auto | The simplest way to shoot basic images. Settings are adjusted automatically. |
|  | Program | The camera automatically adjusts suitable shooting settings like shutter speed and aperture values. |
|  | Intelligent Scene | The camera detects the shooting conditions and automatically switches to the appropriate scene mode. |
|  | Portrait | Focus on portraits and soften the background to give the image a sense of depth. Enhance natural skin tones. |
|  | Landscape | This feature is used to emphasize wide scenic views. |
|  | Sunset | This feature enhances the red hue for recording sunset images. |
|  | Backlight | This feature is used to capture the image of a backlight object by changing the metering. |

| | | |
|---|-----------------|---|
|  | Kids | This feature is used to capture still images of moving kids. |
|  | Night Scene | This feature is used to capture images with night scenery background. |
|  | Stylish | This feature is used to capture images with over-saturated colors, off-kilter exposure or blurring. |
|  | Fireworks | For shooting firework displays in vivid colors. It's recommended to use a tripod. |
|  | Snow | This feature is used for beach and snow scenes. |
|  | Sports | This feature captures photos in high speed motion. |
|  | Party | This feature is used for wedding or indoor party settings. |
|  | Candlelight | This feature is used to capture warm candle light effects. |
|  | Night Portrait | This feature is used to capture portrait pictures with night or dark background. |
|  | Soft Skin | This feature enhances skin tone thus facial skin appears smooth. |
|  | Flowing Water | This feature enhances smooth effects like water or silk. |
|  | Food | This feature is used to capture food photos. The increased saturation in this mode makes the captured photo more enticing. |
|  | Building | This feature enhances the edges of captured photos. |
|  | Text | This feature enhances the black and white contrast normally used when capturing text photos. |
|  | Foliage | This feature boosts the saturation of greens to give a rich color to foliage. |
|  | Auction | This feature combines up to 4 shots into a single image and provides 4 patterns to select for usage of auction. |
|  | Smile Capture | This feature uses face tracking to auto detect faces to capture. When smiles are detected, it continuously captures the photo. |
|  | Blink Detection | This feature detects if the subject blinked an eye when the photo is captured and gives the user an option whether to save it or not. |
|  | Pre-composition | This feature captures an photo temporarily as a reference. Full press shutter after referring the subject to the reference point. |

| | | |
|---|---------------|---|
|  | Love Portrait | This feature uses face tracking to auto detect faces to capture portraits photos without the help of others. When two or more faces are detected, AF is activated and the camera begins a 2 second countdown. If the faces have not moved during the countdown, the camera will automatically capture photos without pressing the Shutter button. |
|  | Self Portrait | This feature set zoom to wide end. When one or more faces are detected, AF is activated and the camera begins a count down. If the faces have not moved during the count down, the camera will automatically capture photos. |
|  | D-Lighting | This feature enhances the shadow and highlight details of a photo. |
|  | Voice REC | This mode is used to record audio clips. |

After selecting the scene mode, the selected mode, except Voice Rec., will be added to the forefront in **My Mode** of Function Menu. In the Menu Options, the **Auto** mode is fixed and the other 5 items can display the most recent used modes. See "Using the Function Menu" on page 22.

Using Intelligent Scene

This feature is most useful for novice users to capture great photos even without basic knowledge of photography. Simply frame the shot with the help of Intelligent Scene Mode, the camera automatically recognizes 11 kinds of scenes - Portrait, Landscape, Sunset, Macro, Text, Snow, Backlight, Backlight Portrait, Night Scene, Night Portrait and Foliage - and selects the ideal settings.

Intelligent scene icon. After the camera detects the shooting conditions, this icon changes to show the detected scene mode.

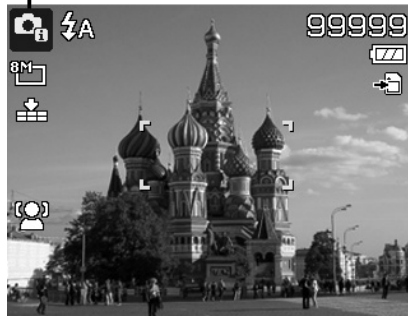

The camera changed to Landscape mode automatically.

To activate Intelligent Scene

1. Select from the Scene Mode submenu.
2. Focus the camera on the subject to capture.
3. The camera detects the shooting conditions and switches to an appropriate scene mode.
4. Half press the Shutter button to focus the subject. The frame turns green to indicate focus is set.
5. Press the Shutter button to take the shot.

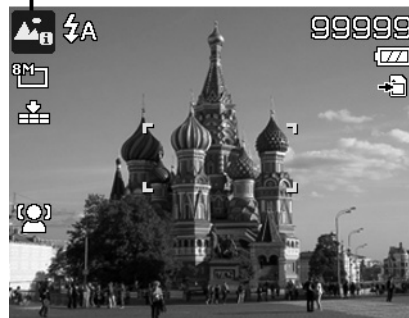

Using Kids Mode

Tactically, kids are the most difficult to photograph. They tend to be highly animated and can be a real challenge to make them pay attention for more than just a second or two. To capture a great moment for your kids, just keep the camera in kid mode. The mode provides higher shutter speed and always focuses on moving subject.



Using Sports Mode

When you need a series of sports motion photos, such as a golf swing, or try to capture the images of a flying hummingbird/butterfly, be sure to switch the scene mode to sports mode. This mode provides shutter in **Burst speed** (Keep shooting images long as the Shutter button is pressed) which allows you to capture a sequence of pictures that are frames apart clearly. The default setting of Sports Mode is Off, please enable the function first before capture the photos.



Make sure you have plenty of memory in your memory card as you will need it when you start shooting.

Using Party Mode

Let the Party mode on! It can be difficult to get everyone on a party. While you have the whole gang together, take a group or family portrait. You'll miss fewer shots, and have more time to focus on enjoying the party.

Using Soft Skin mode

When the soft skin mode is activated, it makes wrinkles and lines look less conspicuous, while preserving resolution in areas of the picture outside of the skin. The camera detects skin color area, such as the face and processes the photo to make the skin appear smooth.

Using Food Mode

How to share your dining experiences and comments of interesting widgets on your blog by close-up photos? Just get the camera and set the scene with food mode. This mode features on macro focus and auto flash designed for close-up photography.



Macro focus and Auto Flash are enabled by using Food mode.

Using Foliage Mode

A scenic photo, such as a garden or forest scene, that full of dull green colors is boring. In foliage mode, the greens, blues, are brilliantly enhanced making scenic pictures pop out with bright color.

Using Stylish Mode

The Stylish mode applies the following effects on the photo:

1. Over-saturated colors
2. Off-kilter exposure
3. Blurring
4. Darkening around the edges of photo



Original



Stylish



When you active Stylish mode, you can select Stylish settings (Stylish 1, Stylish 2, Stylish 3, Stylish 4) in Color mode under Function menu. The Stylish settings also support Video Record mode.

Using Auction Mode

It's hard and wastes a lot of time to combine several photos by software. Select Auction mode and choose a pattern, then take a few shots from different angle. The camera composes a combined image in lower resolution suited to online posting.

1. Select Auction mode from Scene mode menu.
2. Use the 4-way navigation control to choose a pattern.
3. Press the **OK** button to start shooting.

4. Frame the subject and press the **Shutter button** to take the first shot.

5. Press **OK** button to continue the second shot.
6. Or, press **Menu** button to cancel the process.

7. Repeat step 4 to 6, until the pattern is filled with photos.
8. Press **OK** button to save the composed image.
9. Or, press **Menu** button to cancel the process.

10. The camera save the photo memory.
11. Use USB cable or memory card reader (Please refer to "Connecting the Camera to a PC" on page 60) to transfer the image to PC and upload it to website.

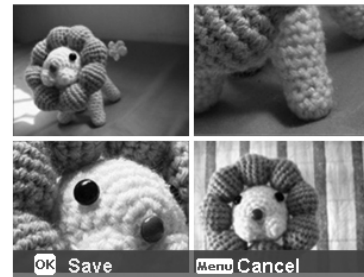
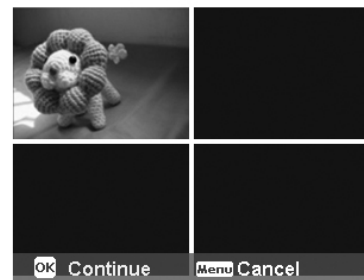
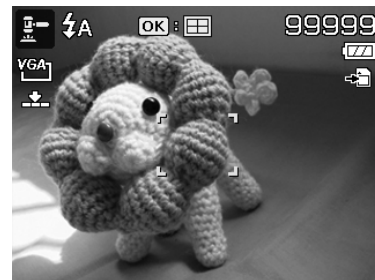
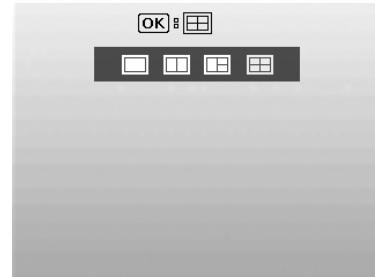

Auction mode provides 4 kinds of pattern as follow

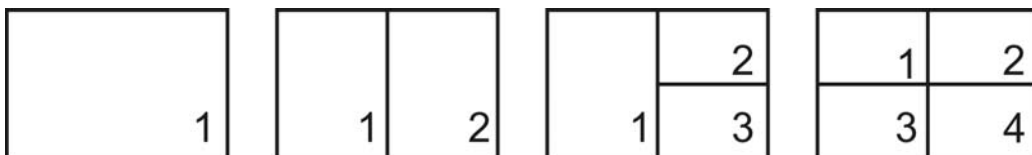

The photo is set to low quality and VGA (640x480) size only.

Using Smile Capture Mode

Smile capture mode detects every smile all the time and performs Automatic Focus (AF) to capture a photo without pressing Shutter button.

Follow the instructions to get a **Happy** photo by Smile Capture Mode:

1. Select Smile capture mode from scene menu.
2. Focus the camera on the subject to capture.
3. When a smile is detected, the white focus frame turns green to denote camera shutter and take a shot automatically.



Using Pre-composition Mode

Asking someone in the crowd to take a picture for you often leads to disappointment. Use this mode to help improve the results.

Pre-composition helps you get the background you want, even if you need to ask someone else to record the image for you.

Basically, Pre-composition is a two-step process.

1. Compose the background you want and press the **Shutter button** (full press), which causes 1/3 of semi-transparent image of the background to remain on the LCD monitor. Press **Menu button** to cancel the semi-transparent temporarily image.



2. Ask someone else to record a shot of you against your original pre-composed background, telling him/her to compose the photo by using the 1/3 semi-transparent screen image as a guide.



3. Move your position until photographer confirm your whole or half body in the frame and in the right place.
4. Press the Shutter button. Camera stores the photo produced by this step only.



Using Love Portrait

Want to take a good photo when there are just two of you? All you have to do is hold the camera and show your smiles together.

When two or more faces are detected, AF is activated and the camera begins a 2 second countdown. If the faces have not moved during the countdown, the camera will automatically capture photos without pressing the **Shutter button**.

Using Self Portrait

When you are the one taking the picture for yourself, then self portrait mode is necessary besides the tripod. With your long arm's help, the camera begin face tracking in self portrait mode. When one or more faces are detected, AF is activated and the camera begins a 2 second countdown. If the faces have not moved during the countdown, the camera will automatically capture photos without pressing the **Shutter button**.

Tips to make a great shape by self portrait photography:

- Lean in towards the camera to reduce double chin.
- Angle your body and bend your arms to look slimmer.
- Keep your shoulders back.

Using D-Lighting Mode

Active D-Lighting mode preserves details in highlights and shadows, creating photos with natural contrast. Use for high contrast scenes, for example, when photographing brightly light outdoor scenery through a door/window, or taking pictures of shaded subjects on a sunny day. With this feature, the adjustment of contrast is accomplished in-camera and requires no additional post-processing for the bulk of photos.

Using Voice Recording

1. From the Scene menu, select **Voice REC**. The Voice Recording screen layout is displayed on the LCD monitor.
2. Press the **Shutter button** to start recording.
3. Press the **Shutter button** again to stop recording.

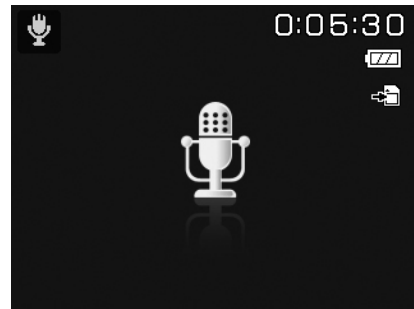

Setting the Self-timer

Your camera features a Self-timer which can be set in the Self-timer function in the Record Menu. The Self-timer allows you to take photos after a pre-defined delay. While burst lets you take consecutive shots. This function is only available in recording photos. The Self-timer setting is automatically set to off when you turn off the camera.

To set the Self-timer

1. From the Record menu, select **Self-timer**.
2. Use the 4-way navigation control to move through the selections.
3. Press the **OK** button to save and apply changes.



The table below shows the available Self-timer settings.

| Icon | Item | Description |
|------|---------|--|
| | Off | Captures a photo without time delay. |
| | 10 Sec. | Sets a 10-second delay to capture photo after pressing the Shutter button. |
| | 2 Sec. | Sets a 2-second delay to capture photo after pressing the Shutter button. |
| | Double | Performs delay and capture twice: <ul style="list-style-type: none"> • Performs a 10-second delay, then captures the photo. • Performs another 2-second delay then captures the photo again. |

Setting the AF Area

AF stands for Automatic Focus. This feature determines the area on which the camera focuses.

To set AF Area

1. From the Record menu, select **AF Area**.
2. Use the 4-way navigation control to move through the selections.
3. Press the **OK** button to save and apply changes.

The table below shows the available AF area settings.



| Icon | Item | Description |
|------|---------------|---|
| | Face Priority | The camera automatically detects faces. Up to 10 faces can be detected at the same time. |
| | Wide | The camera automatically selects focus area within the wide frame. |
| | Center | The focus area is fixed on the center. |
| | Tracking AF | The camera will focus the subject as it moves and keep it continually in focus automatically. |

Setting Sharpness

This function allows you to enhance or soften finer details of your photos.

To set Sharpness

1. From the Record menu, select **Sharpness**.
2. Use the 4-way navigation control to move through the selections.
3. Press the **OK** button to save and apply changes.

The table below shows the available Sharpness settings.

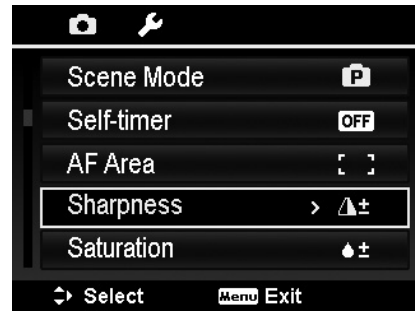

| Icon | Item | Description |
|------|--------|---------------------|
| | High | Sharpens the image. |
| | Normal | Normal sharpness. |
| | Low | Softens the image. |

Setting Saturation

The Saturation function lets you adjust the color saturation in your photos. Use a higher saturation setting for rich colors and a lower saturation setting for more natural tones.

To set Saturation

1. From the Record menu, select **Saturation**.
2. Use the 4-way navigation control to move through the selections.
3. Press the **OK** button to save and apply changes.

The table below shows the available Saturation settings.



| Icon | Item | Description |
|------|--------|-------------------------|
| | High | Enhance the saturation. |
| | Normal | Normal saturation. |
| | Low | Reduce the saturation. |

Setting Contrast

This function allows you to adjust the contrast of your photos.

To set Contrast

1. From the Record menu, select **Contrast**.
2. Use the 4-way navigation control to move through the selections.
3. Press the **OK** button to save and apply changes.

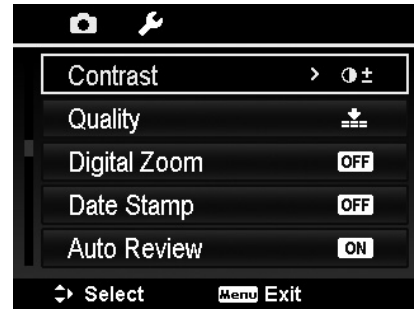

| Icon | Item | Description |
|------|--------|----------------------|
| | High | Enhance the contrast |
| | Normal | Normal contrast |
| | Low | Reduce the contrast |

Setting Quality

This setting allows you to choose the quality (compression) level at which the photo is captured. The quality determines the amount of compression applied to your photos. Fine quality would give you the best images with sharper details and less compression. However, the higher the quality, the more memory space is required in your memory card.

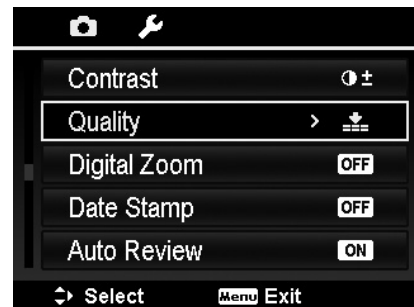

| Icon | Item | Description |
|------|-----------|-----------------------|
| | Superfine | 3x compression rate. |
| | Fine | 7x compression rate. |
| | Normal | 12x compression rate. |

Setting the Digital Zoom

This feature controls the digital zoom mode of your camera. Your camera enlarges an image using the optical zoom first. When the zoom scale exceeds 5x, the camera uses digital zoom.

To set Digital Zoom

1. From the Record menu, select **Digital Zoom**.
2. Use the 4-way navigation control to move through the selections.
3. Press the **OK** button to save and apply changes.

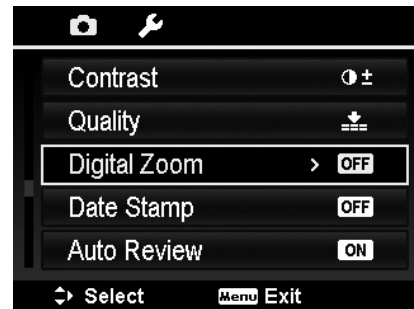

The table below shows the available Digital Zoom settings.

| Icon | Item | Description |
|------|------------------|--|
| | Intelligent Zoom | Enlarges the image digitally with almost no distortion. This feature is available for photos only. |
| | Standard Zoom | Enlarges all photo sizes up to a maximum of 5x in preview, but the image quality deteriorates. |
| | Off | Uses the optical zoom only. |



- Digital Zoom is not available in Face tracking on, Video Recording, and Voice Recording modes.
- The maximum Intelligent zoom scale varies depending on the photo type and resolution.

Setting the Date Stamp

The date of recording can be printed directly on the photos. This function must be activated before the photo is captured. Once date and time are stamped on a photo, they can no longer be edited or deleted.

Limitations of Date Stamp functions are as follows:

- Available for photos only.
- May slow down AEB/ Burst mode when Date Stamp is enabled in AEB/ Burst mode.
- In vertical or rotated photos, the date and time on your images still appear horizontally.

To set Date Stamp

1. From the Record menu, select **Date Stamp**.
2. Use the 4-way navigation control to move through the selections.
3. Press the **OK** button to save and apply changes.

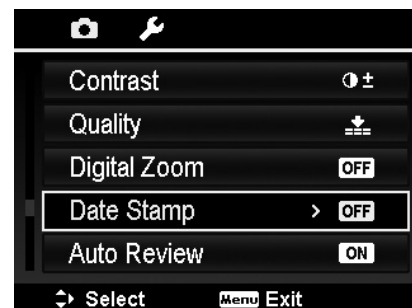

Setting Auto Review

The Auto Review function lets you view the captured photo right after shooting it.

If Auto review is On, the camera will display the captured image for **1 second** on the LCD monitor.

To set Auto Review

1. From the Record menu, select **Auto Review**.
2. Use the 4-way navigation control to move through the selections.
3. Press the **OK** button to save and apply changes.

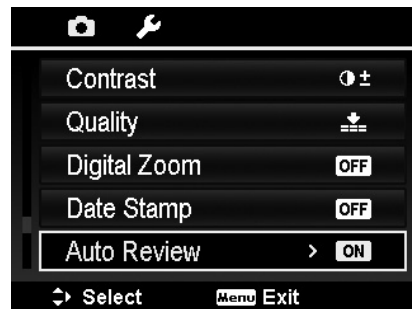

Setting Grid Line

The Grid Line function will show a framing grid on preview for taking pictures. Available settings are: **On, Off**.

The configuration of Grid Line will be changed with different aspect ratio.

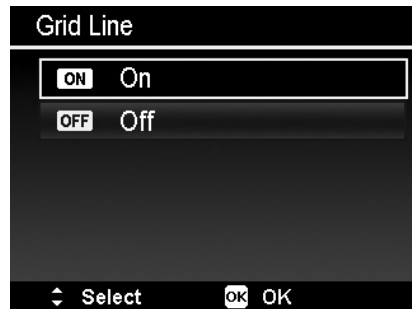

Setting Stabilizer

This function allows you to prevent blurred photos caused by shaking.

1. Enable the **Stabilizer** under the **Record Menu**.
2. Use the 4-way navigation control to move through the selections.
3. Press the **OK** button to save and apply changes.

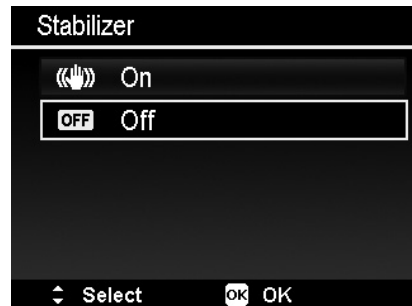

Continuous AF

This function allows you to record video with auto focus method.

1. Enable the **Continuous AF** under the **Record Menu**.
2. Use the 4-way navigation control to move through the selections.
3. Press the **OK** button to save and apply changes.

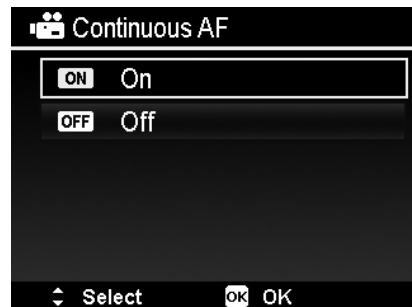

Zoom

Use this feature to enable/disable the zoom control in video recording. When this feature is turned on, voice during lens zooming would not be recorded.

1. Enable the **Zoom** under the **Record Menu**.
2. Use the 4-way navigation control to move through the selections.
3. Press the **OK** button to save and apply changes.

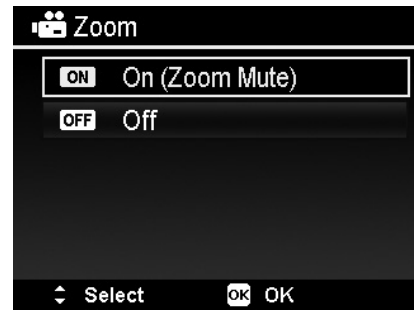

Playback

You can playback the photos, video and audio clips on the LCD monitor.

Viewing in Single Navigation

The Single navigation mode displays the photo one by one on the LCD monitor. To view photos/videos/audio clips, follow the steps below.

1. Press the **Playback button**  on the camera.
2. The LCD monitor displays an photo. To understand the icons and other information on the screen, please see "Photo Mode Screen Layout" on page 13.

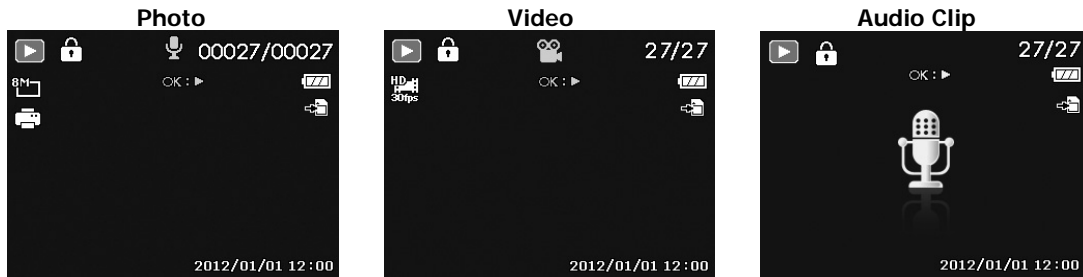

3. Use the 4-way navigation control to view next/previous photo/video/audio.
4. To play a video or audio clip, press the **OK** button. See "Playing Videos" on page 43 and "Playing Voice Recording" on page 44 for more details.

Viewing Thumbnails

This function allows you to view 9-thumbnail photos or by calendar mode on the LCD monitor at the same time. Searching numerous photos is much easier than single view navigation.

To set 9-images mode

1. Press the **Playback button**  on the camera.
2. Spin the **Zoom dial** counterclockwise (left) **once** to enter 9-images mode.
3. Use the navigation controls to move through the items.
4. Press the **OK** button to select the photo and view it normally.

Scroll bar.

If scroll bars appear, it indicates that the screen can be scrolled.

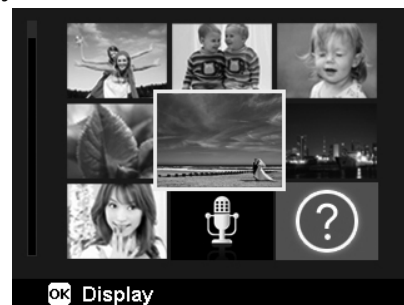

Thumbnail view

To set calendar mode

1. Press the **Playback button**  on the camera.
2. Spin the **Zoom dial** counterclockwise (left) **twice** to view thumbnails in calendar mode.
3. Use the navigation controls to move through the items.
4. Press the **OK** button to select an image and view it normally.





In calendar mode:

- The first file (Including photo, video, audio and error file) recorded on each date appears on the screen.
- Spin the **Zoom dial** clockwise (right) would back to 9-images mode.

Thumbnail icons:

When you view the thumbnails, some images may contain icons. These icons indicate the type of file or recording.

| Icon | Type | Description |
|---|--------------|-----------------------------------|
|  | Voice Record | Indicates a voice recording file. |
|  | File Error | Indicates an error file. |

Zooming photos

The zoom view function works with photos only.

- In normal view, spin the **Zoom dial** clockwise (right) repeatedly until the desired zoom view.
- The 4 arrows on the LCD monitor indicate that the image is zoomed in.
- You can zoom to view an image of up to 12X.
- Use the navigation controls to view the zoomed photo.
- Press the **Menu** button to close zoom view.

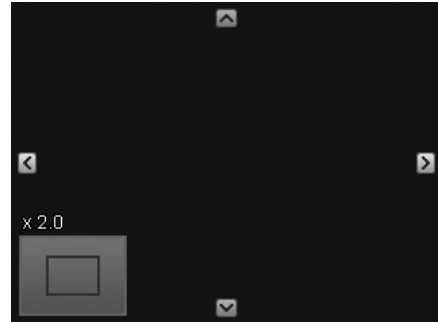

Playing Videos

1. Press the **Playback button**  on the camera.
2. Use the navigation controls to scroll through the saved images. A video clip has a video icon displayed on screen.
3. Press the **OK** button to play the video.
4. During playback, press and hold Left/Right key on the navigation control to fast forward or rewind the video. The camera supports forward and rewind speed of up to 4x.
5. During playback, use the **Zoom dial** to control volume. Spin clockwise (right) to increase volume/Spin counterclockwise (left) to decrease volume.
6. Press the **4-way Navigation Control** Up key to pause playback. Press the **4-way Navigation Control** Up key again to resume. When paused, the play info will remain on screen, but  will become .
7. To forward or rewind the video frame by frame, press the **4-way Navigation Control** Up key to pause playback, then press the **4-way Navigation Control** Left/Right key.
8. Press the **4-way Navigation Control** Down key to stop the playback. The LCD monitor displays the video frame image in Single navigation mode.





- The play info, except the icon , will be displayed when the video is paused, during REW/FF or frame by frame modes
- Volume cannot be adjusted when paused or during REW/FF modes.

Using Video Edit



When a video clip is paused, press the Fn/Delete button to enter Video Edit mode. An Edit Panel displayed in the lower left corner of the screen while the time bar and video length display in the bottom of the screen.



Set Start/End point

1. Press Up/Down key on the navigation control to select  to set start point to trim the beginning of the video;  to trim the end of the video to set end point.
2. Press Left/Right key on the navigation control to move  on each 1/30 second interval. The video length must be at least more than 2 seconds.





3. Select the  to preview or  to save the video clip.
4. Select  and press OK to exit Video Edit mode and return to the paused time whether the Start/End point is set or not.



The edited video clip will be saved as a separate file that can be performed video edit again.

Playing Voice Recording

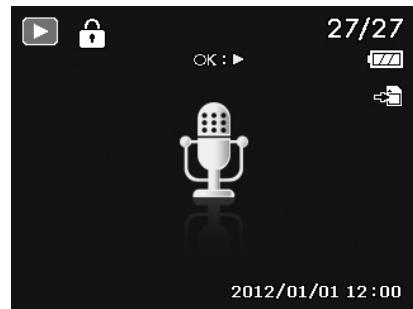

1. Press the **Playback button**  on the camera.
2. Use the navigation controls to scroll through the saved photos. When viewing a voice recording file, the LCD monitor displays the screen layout of Audio clips. See picture on the right.
3. Press the OK button to play the voice recording.
4. During playback, use the **Zoom dial** to control volume. Spin clockwise (right) to increase volume/Spin counterclockwise (left) to decrease volume.
5. Press Up key on the navigation control to pause playback. Press Up key on the navigation control again to resume. When paused, the play info will remain on screen except  .
6. Press Down key on the navigation control to stop the playback. The LCD monitor displays the image in Single navigation mode.



Volume cannot be adjusted during Pause mode.

Playing Voice Memo

Voice memo is separately recorded and attached to a captured photo. See "Voice Memo" on page 51 on how to record voice memo.

1. Press the **Playback button**  on the camera.
2. Use the navigation controls to scroll through the saved photos. A photo file with voice memo has a voice memo icon located on the top center of the LCD monitor. See picture on the right.
3. Press the OK button to play the voice recording.
4. During playback, use the **Zoom dial** to control volume. Spin clockwise (right) to increase volume/Spin counterclockwise (left) to decrease volume.
5. Press Up key on the navigation control to pause playback. Press Up key on the navigation control again to resume. When paused, the play info will remain on screen except  .
6. Press Down key on the navigation control to stop the playback. The LCD monitor displays the photo in Single navigation mode.



Volume cannot be adjusted when you pause the voice memo.

Deleting a Photo/Video/Audio

There are two ways to delete a photo/video/audio:

- Using the **Delete** button.
- Using Playback Menu Delete settings. See "Delete" on page 46.

Using the Delete Button



Use the **Fn/Delete** button on your camera to delete a photo/video/audio clip.

1. Press the **Playback button**  on the camera.
2. View photos/videos/audio clips in Single navigation mode.
3. Use Left/Right key on the navigation control to scroll the display.
4. When the desired photo/video/audio clip is displayed on the LCD monitor, press the **Fn/Delete** button.
5. A confirmation selection appears on screen.
6. Select **Delete**.
7. Press the **OK** button to delete.
8. The next image is displayed on the LCD monitor. To delete another file, use Left/Right key on the navigation control to scroll through the photos/videos/audio clips. Then, repeat steps 6 to 7.
9. To close the Delete function and go back to the single navigation mode, select Cancel.

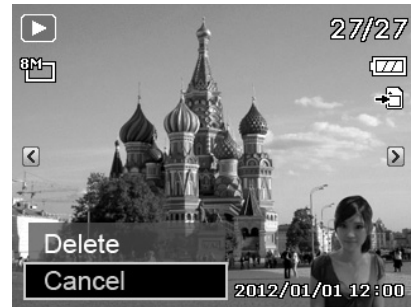

Locked files cannot be deleted at any time. When you try to delete a locked file, the camera displays "File Locked" message on the LCD monitor.

Playback Menu

The Playback menu allows you to edit photos, record voice memo, and setup playback settings.

To go to Playback Menu:

1. Press the **Playback button**  on the camera.
2. Press **Menu button** to launch the Playback Menu.
3. Use Up/Down key on the navigation control to move through the menu selections.
4. To select a menu, press Right key on the navigation control or the **OK** button.
5. Change the submenu settings using the 4-way navigation control.
6. Press the **OK** button to save and apply settings.



Delete

The Delete function allows removing unwanted files in the internal memory or on the memory card. Protected files cannot be erased, to delete, unprotect the file first. See "Protect" on page 48.

To delete a photo/video/audio clip:

1. From the Playback menu, select **Delete**.
2. The Delete submenu is displayed on the LCD monitor.

Available select settings:

- **Single**. Select one file to delete.
- **Voice Only**. Delete only the attached voice memo, not voice clips. The photo is still retained in the memory.
- **Multi**. Select multiple files to delete at the same time.
- **All**. Delete all files.

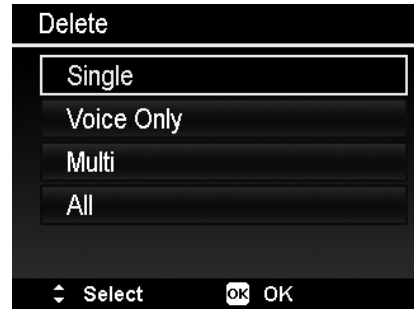

To delete a single file:

1. Select **Single** in the Delete submenu, the photos are displayed on the LCD monitor in single navigation mode.
2. Use Left/Right key on the navigation control to scroll the display.
3. When the desired photo/video/audio clip is displayed on the LCD monitor, select **Delete**.
4. Press the **OK** button to delete.
5. The next photo is displayed on the LCD monitor. To delete another file, use Left/Right key on the navigation control to scroll through the photos/videos/audio clips. Repeat steps 3 to 4.
6. To close the Delete function and go back Playback menu, select **Cancel**.

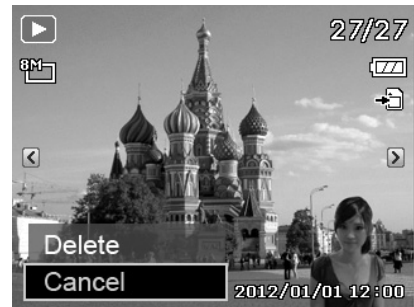

To delete attached voice memo:

1. Press the **Playback button**  on the camera.
2. View photos/videos/audio clips in Single navigation mode.
3. Use Left/Right key on the navigation control to scroll until the desired photo with voice memo is displayed on the screen.
4. Press **Menu** button to launch the Playback Menu.
5. Use Up/Down key on the navigation control to move through the Playback menu selections then select **Delete**.
6. From the Delete submenu, select **Voice only**.
7. A confirmation selection appears, select **Yes**.
8. Press the **OK** button to delete the attached voice memo and go back to Playback mode.



The Voice Only submenu is disabled if the current photo displayed, at the time you access the Delete menu, does not have any attached voice memo.

To delete multiple files:

1. Select **Multi** in the Delete submenu, the photos are displayed in thumbnail view on the LCD monitor.
2. Use the navigation control to move through the files.
3. When the desired photo/video/audio clip is highlighted, press the **OK** button to mark photo/video/audio clip for deletion.
4. Repeat step 3 until all desired photos for deletion are marked.
5. Press the **MENU** button. A confirmation selection appears.
6. Select **Yes** to confirm.

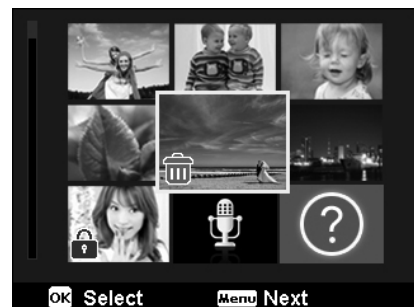

7. Press the **OK** button to delete marked files.

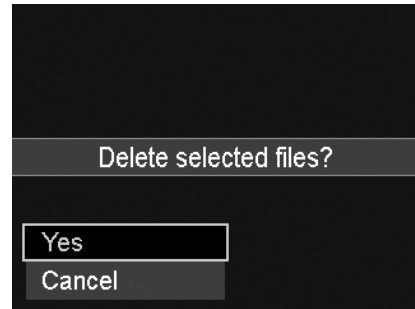

To delete all files:

1. Select **All** in the Delete submenu. A confirmation message appears.
2. Select **Yes**.
3. Press the **OK** button to delete all files.



Slide Show

The slide show function enables you to playback your photos automatically in order one photo at a time.

To view slideshow:

1. From the Playback menu, select **Slide Show**. The Slideshow menu appears.
2. Set the slide show settings.
3. Select **Start**, then press the **OK** button to start the slide show.
4. During slideshow, press the **OK** button to pause slide show.
5. Use Up/Down key on the navigation control to move through the options. Select whether to **Continue** or **Exit** the slide show.
6. Press the **OK** button to apply selected option.

To change slide show settings:

1. From the Slide show menu, use Up/Down key on the navigation control to move through the selections.
2. Select Interval setting. Press Left/Right key on the navigation control to adjust. Choose among the available interval settings: 1 sec., 3 sec., 5 sec., and 10 sec.
3. Select Transition setting. Press Left/Right key on the navigation control to adjust. Choose among the available transition settings:

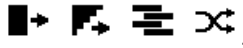

transition settings:

4. Select Repeat setting. Press Left/Right key on the navigation control to adjust. Available settings are:

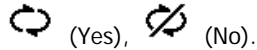

(Yes), (No).

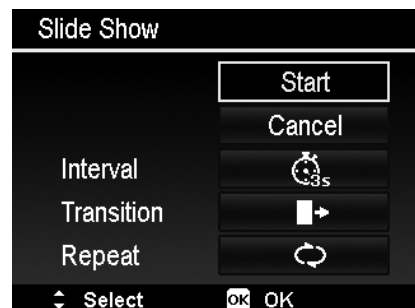

Protect

Set the data to read-only to prevent photos from being erased by mistake.

A protected file has a lock icon  when viewed on Playback mode.

To protect files:

1. From the Playback menu, select **Protect**.
2. The Protect submenu is displayed on the LCD monitor.
Available select settings:
 - **Single**. Select one file to lock/unlock.
 - **Multi**. Select multiple files from the thumbnail view to lock/unlock.
 - **Lock All**. Lock all files
 - **Unlock All**. Unlock all files.

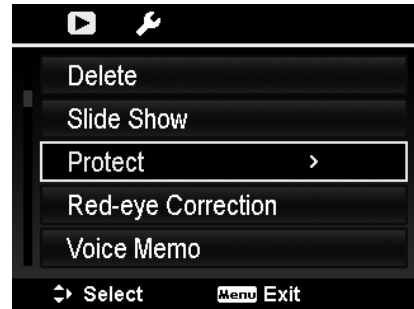

To protect/unprotect a single file:

1. Select **Single** in the Protect submenu, the photos are displayed on the LCD monitor in single navigation mode.
2. Use Left/Right key on the navigation control to scroll the display.
3. When the desired file is displayed on the LCD monitor, press the **OK** button to select **Lock/Unlock**.
4. To close the protect/unprotect function and go back Playback menu, select **Exit**.

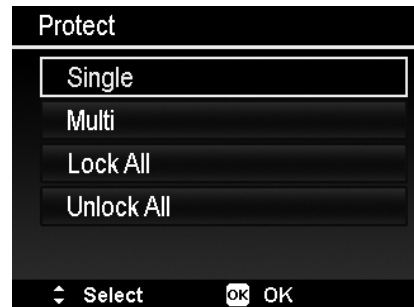

To protect/unprotect multiple files:

1. Select Multi in the Protect submenu, the images are displayed in thumbnail view on the LCD monitor.
2. Use the navigation control to move through the files.
3. When the desired file is highlighted, press the **OK** button to mark/unmark the file clip for protection.
4. Repeat step 3 until all desired files to protect are marked.
5. Press the **MENU** button. A confirmation selection appears.
6. Select **Yes**.
7. Press the **OK** button to lock files and go back to Playback mode.

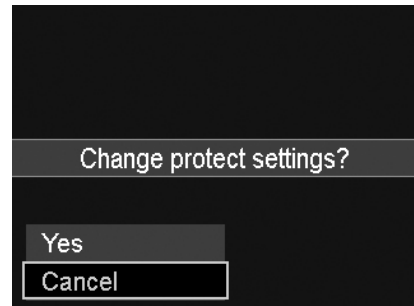

To protect all files:

1. Select **Lock all** in the Protect submenu. A confirmation message appears.
2. Select **Yes**.
3. Press the **OK** button to lock all files.



To unlock all files:

1. Select **Unlock all** in the Protect submenu. A confirmation message appears.
2. Select **Yes**.
3. Press the **OK** button to unlock all protected files.



Red-eye Correction

The Red-eye Correction function is used to reduce red eye in captured photos. This function is only available for photos. Red-eye correction can be applied to a photo several times, but the quality may gradually deteriorate.

To activate Red-eye Correction:

1. Press the **Playback button**  on the camera.
2. Press Left/Right key on the navigation control to scroll and select a photo.
3. Press the **MENU** button to launch the Playback menu.
4. Select **Red-eye Correction**.
5. Select **Start**.
6. Press the **OK** button to start correction.
7. After completing Red-eye correction, a menu selection appears. Select whether to:
 - **Overwrite**. Save and replace old file with a new one.
 - **Save As**. Save the new file as a new one.
 - **Cancel**. Cancel red-eye correction.
8. Press the **OK** button to save/cancel changes.



Voice Memo

A maximum of 30 seconds of audio can be recorded as a memo for captured photos.

To record voice memo:

1. Press the **Playback button**  on the camera.
2. Press Left/Right key on the navigation control to scroll and select a photo to attach voice memo to.
3. Press the **MENU** button to launch the Playback menu.
4. Select **Voice Memo**.
5. Select **Start**, then press the **OK** button to start recording.
6. Press the **OK** button again to stop recording.

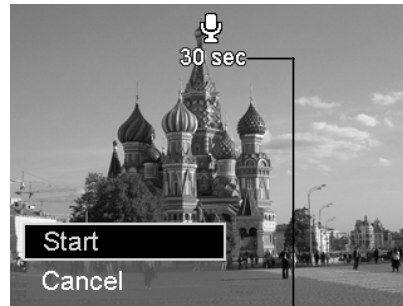
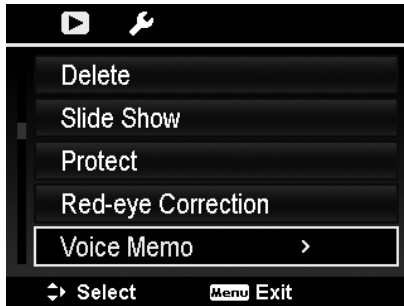

Time left (n seconds) for recording.



When you record voice memo to a photo with an existing voice memo, the old recording file would be replaced by the new one.

Color Mode

The Color Mode function lets you adjust edit photos to apply different colors or tones for a more artistic effect. Edited photos in this function are saved as a new file.





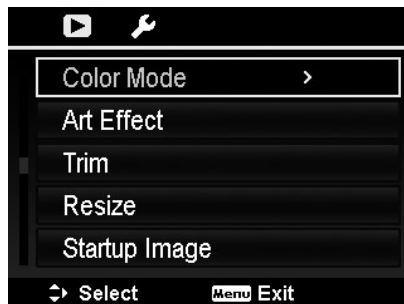

To activate Color Mode:

1. Press the **Playback button**  on the camera.
2. Press Left/Right key on the navigation control to scroll and select a photo to edit.
3. Press the **MENU** button to launch the Playback menu.
4. Select **Color Mode**. The Color Mode submenu appears.



5. Press Left/Right key on the navigation control to scroll and select an option. As you move through the selection, the preview on the LCD monitor changes synchronously.

The succeeding table shows the available settings.

| Icon | Item | Description |
|---|-------------|------------------------------------|
|  | Off | No effect is added to the photo. |
|  | Sepia | Photo is saved with a sepia tone. |
|  | B&W | Photo is saved in black and white. |
|  | Vivid Red | Photo is saved with reddish tint. |
|  | Vivid Green | Photo is saved with greenish tint. |
|  | Vivid Blue | Photo is saved with bluish tint. |

Art Effect

Art Effect function is only applicable to photos with different artistic effect. Edited photos in this function are saved as a new file.





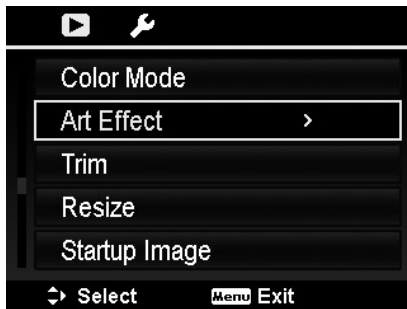

To activate Art Effect:

1. Press the **Playback button**  on the camera.
2. Press Left/Right key on the navigation control to scroll and select a photo to edit.
3. Press the **MENU** button to launch the Playback menu.
4. Select **Art Effect**. The Art Effect submenu appears.



5. Press Left/Right key on the navigation control to scroll and select an option. As you move through the selection, the preview on the LCD monitor changes synchronously.

The succeeding table shows the available settings.

| Icon | Item | Description |
|---|------------------|--|
|  | Off | No effect is added to the photo. |
|  | Negative | Image appears to be the opposite of the original photo. |
|  | Mosaic | Photo is applied with mosaic tiles. |
|  | Astral | Photo is applied with starburst. |
|  | Miniature Effect | The parts of photo will be blurred and make the scene looks like a miniature scale model. It is recommended to apply the photo that captured from a high angle to simulate the miniature effect. |
|  | Painting | Photo is applied with watercolor effect. |
|  | Sketch | Photo is applied with pencil sketch effect. |



Every time when launching the submenu, the cursor is located on "Off".

Trim

The Trim function allows you to trim a photo to another image size. This function is only available for photos

To trim a photo:

1. Press the **Playback button**  on the camera.
2. Use Left/Right key on the navigation control to scroll and select a photo to trim.
3. Press the **MENU** button to launch the Playback menu.
4. Select **Trim**. The Trim screen layout is displayed on the LCD monitor.
5. Use the **Zoom dial** to change size as zoom in/out.

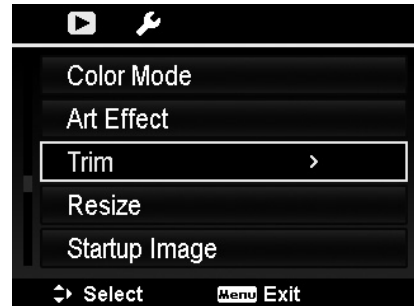

| No. | Description |
|-----|--|
| 1 | Enlarged image |
| 2 | 4-way indicator |
| 3 | Trimmed size |
| 4 | The approx. location of the trimmed area |
| 5 | Image area |



6. Use the navigation controls to move the photo.
7. Press the **OK** button to apply changes. A menu selection appears.
8. Select whether to:
 - **Overwrite**. Save and replace the old file with the new one.
 - **Save As**. Save the new file as a new one.
 - **Cancel**. Cancel Trim.
9. Press the **OK** button to save/cancel changes.



- Trim function is not available for photos with photo size set to VGA.
- All photos will be trimmed in 4:3 ratio regardless of its original photo ratio.

Resize

Resizes a previously saved photo and only resizing to a smaller size is available.

To resize a photo:

1. Press the **Playback button**  on the camera.
2. Use Left/Right key on the navigation control to scroll and select a photo to resize.
3. Press the **MENU** button to launch the Playback menu.
4. Select **Resize**. The Resize submenu is displayed on the LCD monitor.
5. Select size among: 8M, 5M, 3M, and VGA. Available size settings may vary depending on original photo size. Unavailable settings appear as gray icons in Resize submenu.
6. After selecting size, a menu selection appears. Select whether to:
 - **Overwrite**. Save and replace old file with a new one.
 - **Save As**. Save the new file as a new one.
 - **Cancel**. Cancel resize.
7. Press the **OK** button to save/cancel changes.

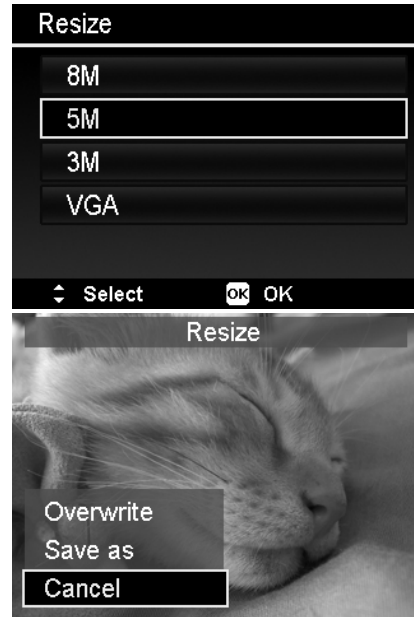

Resize function is not available for photos with photo size set to VGA.

Startup Image

You can specify the startup image from the captured photos for camera.

1. Press the **MENU** button to launch the Playback menu.
2. Select **Startup Image**. The menu selection appears.
3. Select options:
 - **System**. Use camera default image.
 - **My Photo**. Use Left/Right key on the navigation control keys to scroll and select desired image.
 - **Off**. Disable the startup image.
4. Press the **OK** button to apply changes.

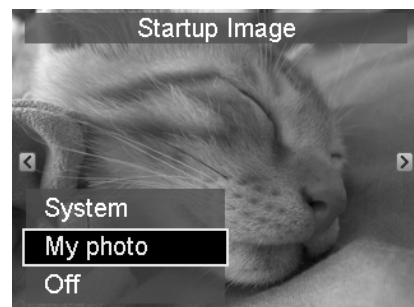

The startup image will still be displayed startup even if the selected image was deleted.

DPOF

DPOF is the abbreviation for Digital Print Order Format, which allows you to embed printing information on your memory card. You can select the photos to be printed and how many prints to make with the DPOF menu in the camera and insert the memory card to the card compatible printer. When the printer starts printing, it will read the embedded information on the memory card and print the specified photos.

To set DPOF:

1. Press the **MENU** button to launch the Playback menu.
2. Select **DPOF**. The submenu appears. Available settings are as follows:
 - **Single**. Select a single photo to mark.
 - **All**. Mark all photos in the memory card.
 - **Reset**. Reset all DPOF settings to initial default settings.

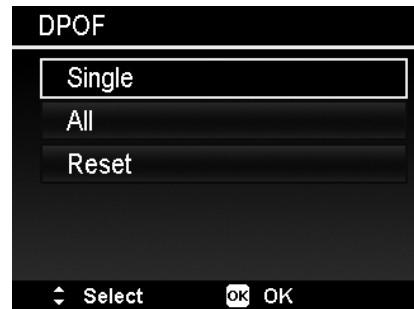

To set DPOF on a single photo/all photos:

1. Select **Single** or **All** on the DPOF submenu.
2. For single image, use Left/Right key on the navigation control to scroll and select an image to mark for printing.
3. Specify the number of copies. Use Up/Down key on the navigation control to increase/decrease number.
4. Press the **Fn/Delete** button to toggle between turning on/off the date stamp.
5. Press the **OK** button to save DPOF settings.



To reset DPOF:

1. Select **Reset** on the DPOF submenu. A confirmation message appears.
2. Select **Yes**.
3. Press the **OK** button to reset DPOF settings.



Radial Blur

The Radial Blur is an effect creates blurs around a point.

To set Radial blur for an image:

1. Use Up/Down key on the navigation control to specify the level of blurs. The adjusting result on preview synchronously while selecting the level.
2. Press the **OK** button to proceed save options.
3. Available settings are as follow:
 - **Overwrite**. Save and replace the old file with a new one.
 - **Save As**. Save the new file as a new one.
 - **Cancel**. Cancel Radial blur.

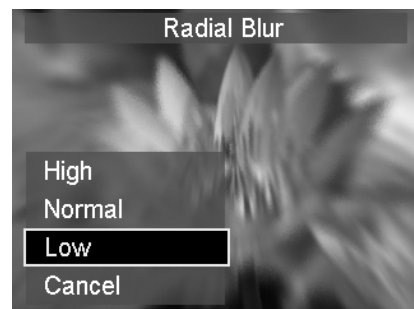

Using the Setup Menu

You can access the Setup menu whether you are in Record or Playback mode. The Setup menu allows to configure general camera settings.

To go to Setup Menu:

1. Press **Menu** button to launch the Record/Playback Menu.
2. Use Left/Right key on the navigation control to switch the menu tab to **Setup** menu.
3. Use Up/Down key on the navigation control to move through the menu selections.
4. To select an item, press the **OK** button or Right key on the navigation control key.
5. Change the submenu settings using the 4-way navigation control.
6. Press the **OK** button to save and apply settings.



Setting Sounds

Use the Sound menu functions to control the sounds produced by the camera.

1. From the Setup menu, select **Sounds**.
2. Adjusts sound settings.
3. Press the **OK** button to apply changes.

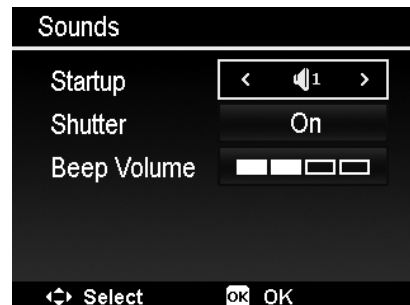

| Item | Available Settings | Description |
|--------------------|--------------------------------|--|
| Startup | Sound 1, Sound 2, Sound 3, Off | Selects the startup sound when camera is turned on. |
| Shutter | On, Off | Enables or disables shutter sound when Shutter button is pressed. Shutter sound is not available when recording videos or voice clips. |
| Beep volume | 0-4 | Adjusts volume. |

Setting Power Save

The Power Save function allows you to set an idle time after which the camera automatically sets to sleep mode to save power. After a minute of being in sleep mode, the camera eventually turns off power.

This function is not available in the following instances:

- Recording a video or audio file
- Playing a slideshow/video/audio file
- Using the USB connector

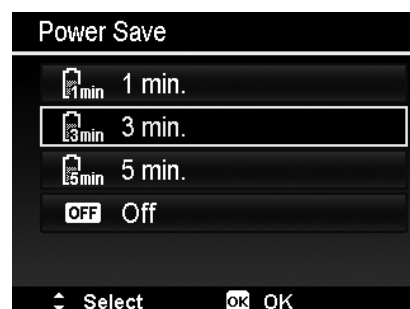

Setting LCD Save

Enable the LCD Save function to automatically decrease the LCD brightness to conserve battery power. When the camera is idle for 20 seconds, the LCD darkens. Press any button to resume to normal brightness.

- The camera is idle and enters LCD Save mode when no buttons are pressed. LCD Save, though enabled, does not function during video playback, slideshow and video recording.

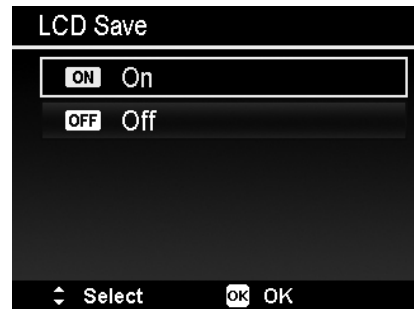

Setting Date & Time

Use the Date & Time function to set the date and time of your camera. This function is useful in attaching date stamps on captured photos. Your camera uses a 24-hour time format.

1. Press the navigation controls to adjust date and time value. By holding down Up/Down key on the navigation control, the numeric values changes continuously.
2. Press the **OK** button to apply changes.

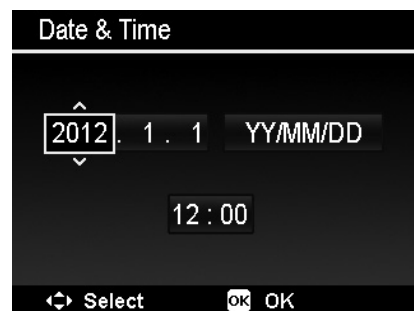

Setting Language

Specify in which language menus and messages are to be displayed on the LCD monitor.

1. Use the navigation control to scroll through the list and select the desired language.
2. Press the **OK** button to confirm and apply settings.



Setting Display Mode

This function controls the icon display on LCD monitor for both Record mode and Playback mode.

Available settings are: On, Detailed, Off.

If set Display Mode to Off, the mode icon and remaining shots will display for 2 seconds in following situations:

- Power on the camera
- Switch from Playback to Record mode
- After shooting
- Close the menu and back to preview

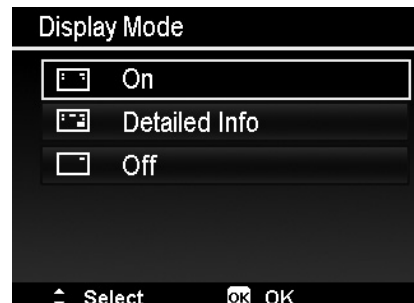

Setting File Numbering

This function allows you to select the method in which to assign file numbers to photos.

Available settings are:

- **Series.** Assigns number to files in sequence even if the folder is changed.
- **Reset.** The file numbering will start from 0001 each time the folder is changed and "Format" is processed.

To understand folder and file structure of your camera, see "About Folder and File Names" on page 63.

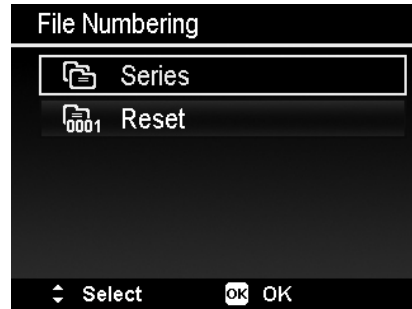

Setting TV Out

Use the TV Out function to adjust video output signal to accommodate different regional settings. If TV out is not set correctly, the photo may not display properly on TV.

Available settings are:

- **NTSC.** Applicable in Japan, USA, Canada, Taiwan and others.
- **PAL.** Applicable in Europe, Asia (excluding Taiwan), Oceania and others.

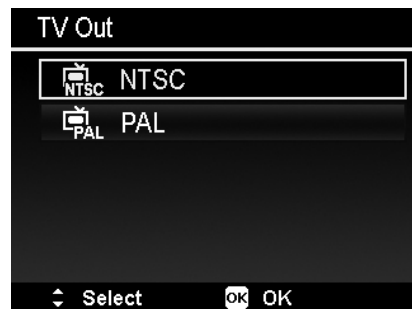

Setting LCD Brightness

Select a brightness level for the LCD monitor.

Available settings are:

- **Auto.** Auto detects the LCD brightness.
- **Bright.** Enhance the LCD brightness.
- **Normal.** Normal LCD brightness.

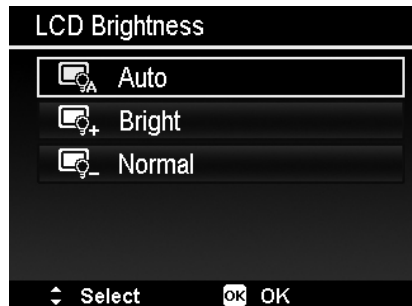

Setting Memory Kit

This utility formats the internal memory (or memory card) and erases all stored photos and data.

Available settings are:

- **Format.** Select to format currently used memory.
- **Copy to Card.** Select to copy all files stored in the internal memory to the memory card.

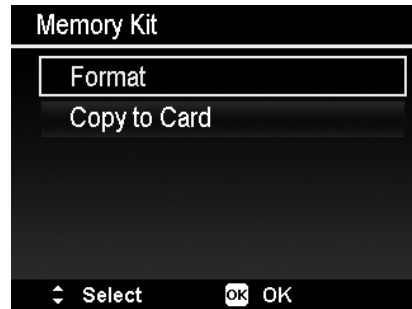

- If the photos were saved in the internal memory when inserting memory card into the camera. You can use **Copy to Card** function in order to copy all photos from the internal memory into memory card.
- If there is no memory card or the internal memory is empty or plug in lock card, the Copy to Card function is disabled.

Reset All

Use this function to reset the camera to its factory settings. However, the following settings are exceptions and not affected by Reset.

- Date & Time
- Language
- TV Settings
- Custom White Balance data



Making Connections

You can connect your camera to: computer, or a printer.

Connecting the Camera to a PC

You can transfer photos, videos and audio files to your PC.

1. Connect one end of the USB cable to an available USB port on your computer
2. Connect the other end of the USB cable to the USB terminal on the camera.
3. Power on the camera.
4. The USB mode menu appears on the screen. Select **Computer** by using Up/Down key on the navigation control and press the **OK** button.

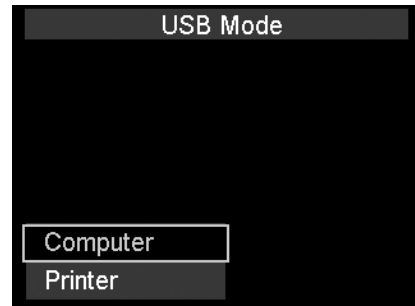
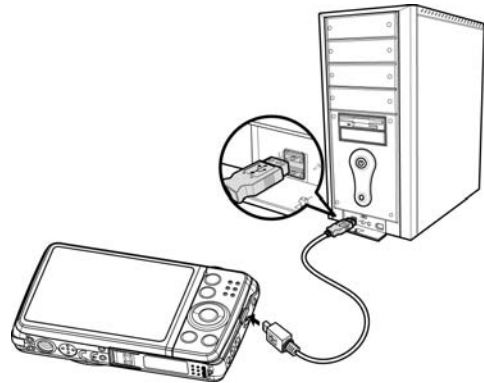

5. The PC starts to detect the connection while the LCD monitor appears **Connecting...**

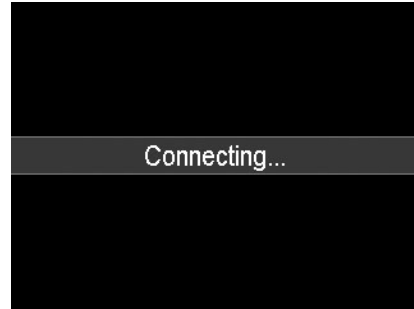

6. Connection established after **PC MODE** appeared on the LCD monitor

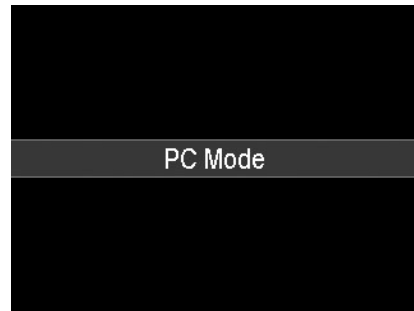

7. Access the files in the camera by your PC.



- The camera's internal memory and memory card would display as removable drives in PC.
- After the connection, no photo is displayed on the LCD monitor.

Connecting the Camera to a Printer

You can print your images directly using a **PictBridge compatible** printer.

1. Turn on your Printer. Check that the printer is turned on, there is paper in the printer, and there are no printer error messages.
2. Connect one end of the USB cable to the printer while the other end to USB terminal on the camera.

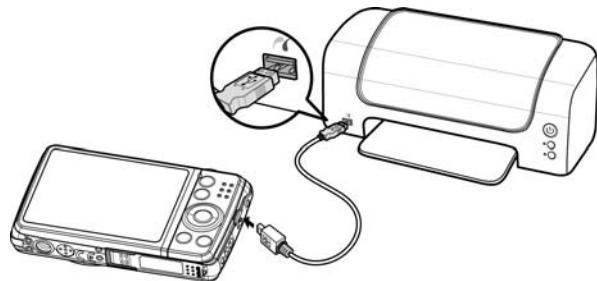

3. The USB mode menu appears on the screen. Select **Printer** by using Up/Down key on the navigation control and press the **OK** button.
4. Enter the print mode and print the selected photos.

For details on the "Setting the Print Mode Menu".

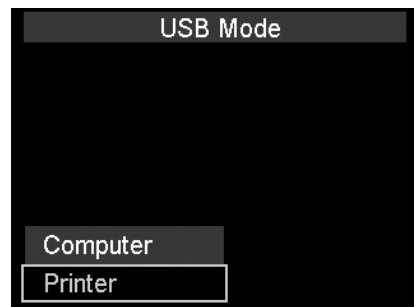

Setting the Print Mode Menu

Print Mode menu appears on the screen after the connection between a printer and your camera is established.

Print Mode includes three major settings:

- **Print Select.** A photo can then be selected to print.
- **Print All.** Prints all photos.
- **Print Index.** Prints all photos as thumbnails.

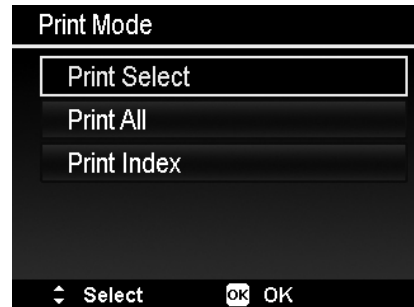

To set Print Select

1. Use Left/Right key on the navigation control to scroll and select a photo for printing.
2. Specify the number of copies. Use Up/Down key on the navigation control to increase/decrease number.
3. Press the **Fn/Delete** button to toggle between turning on/ off the date stamp.
4. Press the **OK** button to enter printer settings.

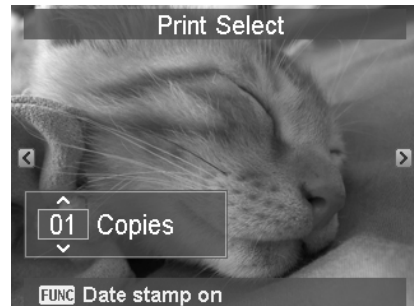

To set Print All and Print Index

Repeat the same steps 2 to 4, then enter printer settings.

To set Printer Settings

1. Use Up/Down key on the navigation control to specify a print option.
2. Modify paper size and quality by Left/Right key on the navigation control. Available setting:
 - Paper size: Default / A4 / 4"x6"
 - Quality: Default / Fine / Normal
3. Select **Print** on the screen for printing.
Or **Cancel** to go back Print Mode.

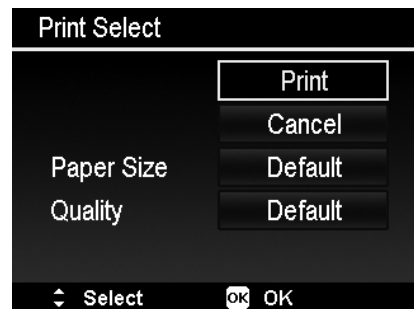

Start Printing

- LCD monitor appears "Now printing...".
- Or press Menu button to stop printing anytime.

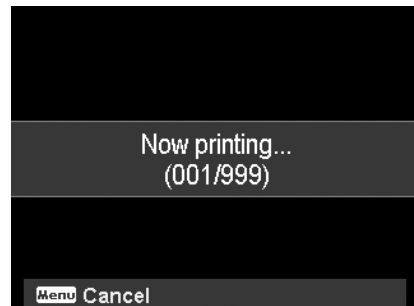

Appendix

About Folder and File Names

Your camera automatically creates specific directory of folder in the internal memory cards to organize captured photos, videos and audio files.

File Naming

File names begin with "DSCI" and followed by a 4-digit number that increases in sequence. File numbering starts from 0001 when a new folder is created.

If the highest folder number is 999 and the highest file number exceeds 9999, the camera will display the warning message "Folder cannot be created". When this happens, try one of the following ways:

- Reset the file number. See "Setting File Numbering" on page 58.



Do not change the folder and file names in the memory card using your PC. It may be unable to playback the data using the camera.

Troubleshooting

| Problem | Cause and/or Action |
|--|---|
| Camera does not turn on. | <ul style="list-style-type: none"> • The battery may not be loaded correctly. • The battery may be exhausted. Charge or replace the battery. |
| Camera turns off automatically. | <ul style="list-style-type: none"> • Power Saving may have activated. Turn power back on. • The battery may be dead. Charge the battery. |
| Power will not turn off. Nothing happens when a button is pressed. | Remove the battery from the camera and then reload it. |
| LCD turns dark. | Press any button except the Power button to turn on the LCD. |
| Empty battery icon is displayed on the LCD, then the camera turns off. | Battery is exhausted, please replace or recharge. |
| LCD monitor displays "No image". | There is no photo file in the memory card. Photo file format may not be supported. |
| LCD monitor displays "Not available for this file". | Function is only available for specific file types. File format is not supported. |
| LCD monitor displays "Memory full". | Memory card is full. Replace the memory card with a new one or delete unnecessary photo/video/audio clips. |
| LCD monitor displays "File locked" | This file is locked. Unlock the file. See "Protect" on page 48. |
| LCD monitor displays "Card locked". | The memory card is protected. Remove the card and slide the write-protect switch to its unlock position. |
| LCD monitor displays "Format error". | The card may be damaged. You can either change the card or wipe to clean the connected points. |
| LCD monitor displays "Card error". | The memory card is protected. Remove the card and slide the write-protect switch to its unlock position. |
| No photo displays on the TV screen. | Incorrect TV-out type was selected. Set the correct TV-out type to match your TV system. |
| The lens is stuck and will not retract or extend.. | Do not force the lens to go back. The type of the battery used may be incorrect or the battery power level is too low. Change the battery or charge the battery before using the camera. |

Specifications

| | |
|---------------------------|---|
| Sensor | 16 megapixels 1/2.3 CCD |
| Lens | Focal Length: 4.6 (W) ~ 23 (T) mm 5X optical zoom, 5x digital zoom |
| LCD monitor | 2.7" Color LCD |
| Focusing Range | Normal: Wide: 0.05 m ~ infinity Tele: 0.6 m ~ infinity Super Macro: 5 cm |
| Aperture | 1:3.2 ~ 6.4 |
| Shutter | Shutter Speed: Auto: 1 - 1/2,000 sec. Night: 15 - 1/2,000 sec. Fireworks: 2 sec. |
| File Format | Still Image: EXIF 2.3 compatible format (JPEG compression) Video: AVI (MJPEG) Audio: WAV |
| Resolution (Photo) | Aspect ratio 4:3 16M (4608 x 3456), 8M (3264 x 2448), 5M (2560 x 1920), 3M (2048 x 1536), VGA (640 x 480) Aspect ratio 3:2 16M (4608 x 3072), 8M (3264 x 2176), 5M (2560 x 1696), 3M (2048 x 1360), VGA (640 x 424) Aspect ratio 16:9 16M (4608 x 2592), 8M (3264 x 1832), 5M (2560 x 1440), 3M (2048 x 1152), VGA (640 x 360) Aspect ratio 1:1 16M (4000 x 4000), 8M (2832 x 2832), 5M (2240 x 2240), 3M (1728 x 1728), VGA (480 x 480) |
| Resolution (Video) | <ul style="list-style-type: none"> • 720p30 • VGAp30 • 720p30 (Painting) |
| Scene Mode | Auto, Program, Intelligent Scene, Portrait, Landscape, Sunset, Backlight, Kids, Night Scene, Stylish, Fireworks, Snow, Sports, Party, Candlelight, Night Portrait, Soft Skin, Flowing Water, Food, Building, Text, Foliage, Auction, Smile Capture, Blink Detection, Pre-composition, Love Portrait, Self Portrait, D-Lighting, Voice REC |
| ISO Equivalent | Auto, 100, 200, 400, 800, 1600, 3200 (3M, VGA), 6400 (3M, VGA) |
| White Balance | Auto White Balance, Daylight, Cloudy, Tungsten, Fluorescent 1, Fluorescent 2, Custom |
| Exposure Control | +2.0EV / +1.7EV / +1.3EV / +1.0EV / +0.7EV / +0.3EV / 0EV / -0.3EV / -0.7EV / -1.0EV / -1.3EV / -1.7EV / -2.0EV |
| Metering | Multi, Center, Spot |
| Self-timer | Off, 10 sec., 2 sec., Double |
| Flash | Auto, Red-eye Reduction, Forced On, Slow Sync, Forced Off |

| | |
|-----------------------------------|--|
| Color Mode (Photo mode) | Off, Vivid, Sepia, Color Accent (Red), Color Accent (Green), Color Accent (Blue), B&W, Vivid Red, Vivid Green, Vivid Blue |
| Color Mode (Video mode) | Off, Stylish 1, Stylish 2, Stylish 3, Stylish 4, Vivid, Sepia, Color Accent (Red), Color Accent (Green), Color Accent (Blue), B&W, Vivid Red, Vivid Green, Vivid Blue |
| Color Mode (Playback Mode) | Off, Sepia, B&W, Vivid Red, Vivid Green, Vivid Blue |
| Art Effect | Off, Negative, Mosaic, Astral, Miniature Effect, Fisheye Lens, Painting, Sketch |
| Storage | Internal memory: 64 MB flash memory External memory: SD (up to 4GB), SDHC card (up to 32GB), SDXC card (up to 64GB) |
| OSD Language | English, Français, Español, Deutsch, Italiano, Русский, Português, Português BR, Nederlands, Türkçe, Polski, Magyar, Rumänisch, Čestina, Български, Croatian, Slovensky, Slovenščina, Ελληνικά, Svenska, Norsk, Suomi, Danish, عربي, Indonesia, Malay, ไทย, 日本語, 한국어, 简体中文, 繁體中文 |
| Interface | USB/AV OUT |
| TV system | NTSC/PAL (selected by Setup MENU) |
| Battery | Lithium ion battery |
| Operating Temperature | 0° C - 40° C |
| Operating Humidity | 0% - 90% |
| Microphone | Built-in |
| Speaker | Built-in |
| Dimensions | 93.24 x 55.39 x 20.22 (mm) |
| Weight | 103 g (no battery) |

Note: Design and specifications are subject to change without notice.