

ER

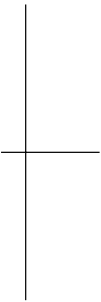

Before using the camcorder, please read this operation manual carefully, especially page vi.

OPERATION MANUAL

ENGLISH

WARNING

To prevent fire or shock hazard, do not expose this apparatus to dripping or splashing. No objects filled with liquids, such as vases, should be placed on the apparatus.

This equipment should be used with the recommended AC adapter or battery pack.

CAUTION

To prevent electric shocks and fire hazards, do NOT use any other power source.

CAUTION

To prevent shock, do not open the cabinet. No user serviceable parts inside. Refer servicing to qualified dealer or service centre.

Important:

Audio-visual material may consist of copyrighted works which must not be recorded without the authority of the owner of the copyright. Please refer to relevant laws in your country.

Power supply:

This unit can be operated by connecting it to either the AC adapter or battery pack. The AC adapter incorporates the AUTO VOLTAGE (AC 110–240 V, 50/60 Hz) function.

NOTE

The LCD panel of this camcorder is a very high technology product with more than 215,000 thin-film transistors*, giving you fine picture detail. Occasionally, a pixel may appear on the screen as a fixed point of blue, green, red, or black. Please note that this does not affect the performance of your camcorder.

*Specifications are subject to change without notice.

Trademarks

- DPOF is a trademark of CANON INC., Eastman Kodak Company, Fuji Photo Film Co., Ltd. and Matsushita Electric Industrial Co., Ltd.
- SD Logo is a trademark.
- All other brand or product names are registered trademarks or trademarks of their respective holders.

Contents

Supplied Accessories	v
Optional Accessories	v
Precautions	vi

Operation References	Part Names	1
	Warning Indicators	4

Preparation	Attaching and Removing the Battery Pack	6
	Charging the Battery Pack	8
	Powering the Camcorder from an AC Outlet	9
	Inserting and Removing a Cassette	10
	Inserting and Removing a Card	11
	Installing the Lithium Batteries	12
	Selecting the Language for the On-screen Display	14
	Setting the Date and Time	15
	Using the Lens Cap	16
	Adjusting the Hand Strap	17
	Using the Grip	17
	Detaching the Lens Hood	18
	Using the Viewfinder	18
	Using the LCD Monitor	20
	Tips on Recording Positions	21

Basic Operations	Camera Recording	
	Selecting the Camcorder Mode	22
	Easy Camera Recording on Tape in Full Auto Mode	23
	Zooming	24
	Power Standby Mode	25
	Turning on/off the Backlight	25
	Auto Focus	26
	Macro Shots	26
	Remaining Recording Time Display	26
	Remaining Battery Power Display	27
	Information Display for Battery Usage	27
	Using Earphones (Commercially Available)	28
	Adjusting the Phones Volume	28
	Playback	
	Tape Playback	29
	Volume Control	30
	Still	30
	Video Search	30
	Watching Playback on a TV	31

Useful Features

Control Buttons	32
Using the Mode Screens	32
Using the Menu Screens	33

Camera Recording

Setting the Digital Zoom	34
Backlight Compensation (BLC)	35
Gain-up	36
Fine Picture	37
Using the Built-in LED Video Light	38
Fade In and Fade Out	39
Quick Return	40
Edit Search	41
Still Recording on Tape	41
Digital Image Stabilization (DIS)	42
Wide Mode	43
Power Save Mode	43
Self Recording	44
Recording in LP (Long Play Recording) Mode	46
Selecting the 16-bit Audio Recording Mode	47
Using the Zoom Microphone (Optional Accessory)	48
Windbreak	49

Playback

Using the Remote Control	50
Tape Playback Functions with the Remote Control	51
Selecting the Date and Time of Recording Display	52
Picture Effect Playback	53
Rotate Playback	54
Fine Picture Playback	54
Copying an Image from Tape to Card	55
Stretch Playback	56

Advanced Features

Camera Recording

Manual Focus	57
Returning to Auto Focus	58
Displaying the Manual Setting Screen	58
Adjusting White Balance	59
Manual Iris	61
Manual Gain	62
Setting the Shutter Speed	63
Tips on Manual Settings	64
Setting the Camcorder to Full Auto Mode	64
Scene Menu (Program AE)	65
Digital Picture Effects	66

Contents

Advanced Features

Playback

Using the Time Code	67
Audio Dubbing Feature	68
Selecting the Audio Playback Mode	70
Editing	71
Editing with the DV Terminal (IEEE1394)	72

Digital Still Camera Features

Camera Recording

Selecting the Picture Quality and Image Size	73
Card Recording	75
Recording with the Self-timer	76
Formatting a Card	78
Setting the File Numbering Method	79

Playback

Card Playback	80
Delete Protection	81
Deleting Stored Images	82
Print Order	84
Direct Print	86
Transferring Data on Card to Computer	87
Installing the USB Driver	88
Squeeze Playback	92
Slide Show Playback	93





Appendix

Picture/Backlight Adjustments	94
Turning off the Confirmation Sound	95
Setting the Camcorder to Factory Presettings	95
Demonstration Mode	96
Useful Information	97
Troubleshooting	103
Specifications	107
On-screen Display Index	108
Index	112

Note:

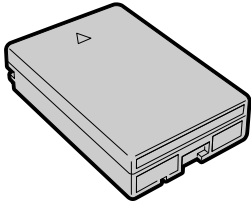
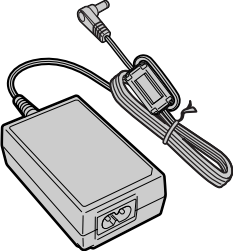
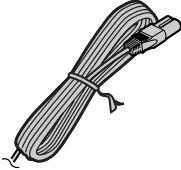
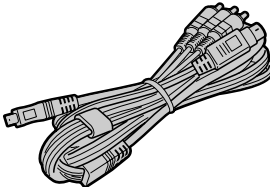
- Before requesting service, please read “Troubleshooting” carefully. (See pages 103–106.)

Supplied Accessories

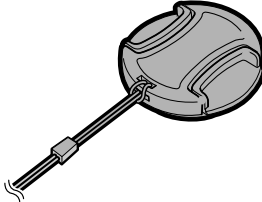
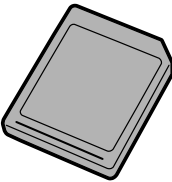
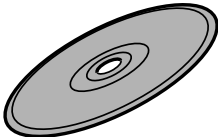
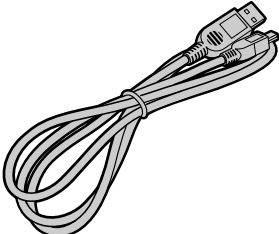
 <p>Battery pack BT-L227</p>	 <p>AC adapter</p>	 <p>Power cord</p>	 <p>Audio/video/S-video cable</p>
 <p>Remote control</p>	 <p>CR2032 type lithium battery for remote control</p>	 <p>CR1216 type lithium battery for camcorder</p>	 <p>Lens cap</p>
 <p>8 MB SD Memory Card</p>	 <p>CD-ROM</p>	 <p>USB cable</p>	

Optional Accessories

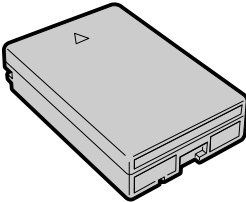
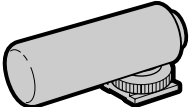
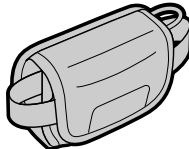
 <p>Standard-life battery pack BT-L227</p>	 <p>Zoom microphone VR-8MC</p>	 <p>External battery with hand strap BT-LCA1</p>
---	---	--

Precautions

- **Before recording an important scene, please perform the recording test, then playback to check if the scene was recorded properly. If noise occurs, use a commercially available cleaning tape to clean the video heads (see page viii).**

- **When the camcorder is not in use, remember to remove the cassette tape, turn off the power, and disconnect the camcorder from the power source.**

- **Do not aim the lens at the sun.**
Do not allow direct sunlight to strike the camcorder lens, whether or not recording is in progress, as it may damage the CCD sensor. Be particularly careful when recording outside.

- **Avoid magnetic sources.**
Using the camcorder near strong fluorescent lights, motors, televisions, or other magnetic sources may adversely affect recorded images.

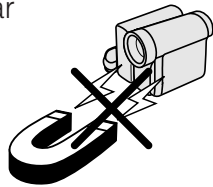

- **Using the camcorder near a broadcasting station or other powerful transmission source may cause buzzing or picture deterioration.**

- **Avoid shocks and dropping.**
Do not drop or otherwise subject the camcorder to hard shocks or strong vibrations. Bumping or striking the unit during recording will generate noise in the recorded image.

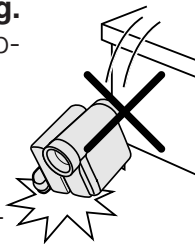

- **Avoid placing the camcorder in close proximity to lighting equipment.**
The heat from incandescent lights may deform the camcorder, or cause it to malfunction.

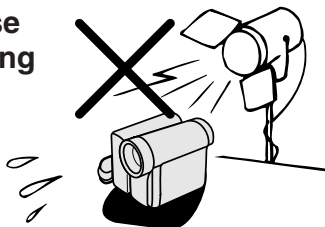

- **Always respect prohibitions or restrictions on the use of electronic equipment on commercial flights or in other sensitive areas.**

- **Be aware of the temperature and humidity.**

You can use your camcorder at 0°C to +40°C, and at 30% to 80% relative humidity. Do not store the unit in an unventilated car in the summer, in direct sunlight, or near strong heat sources; this can result in severe damage to the unit casing and circuitry.

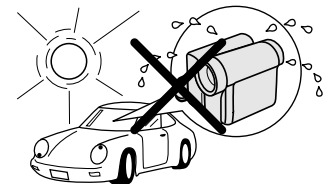

- **Avoid situations where water, sand, dust or other foreign matter could get on or inside the camcorder, and do not use or leave your camcorder in areas with excessive smoke, steam or moisture.**

Such environments can cause malfunctions or cause mildew to form on the lenses. Be sure to keep the unit in a well-ventilated location.

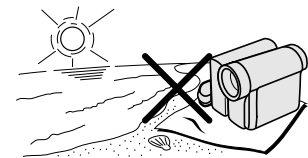

- **Some small, portable tripods may be difficult to attach and may not be sturdy enough to support your camcorder. Be sure to use only a strong, stable tripod.**

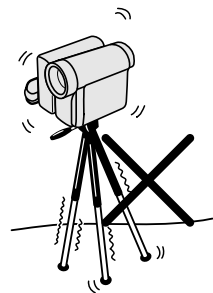

- **When using your camcorder in a cold environment, the LCD monitor screen often appears less bright immediately after the power is turned on. This is not a malfunction. To prevent the camcorder from becoming too cold, wrap it in a thick cloth (a blanket, etc.).**

Dew Formation

• What is “dew formation”?

When cold water is poured into a glass, dew drops form on the glass. This clinging of water drops is called dew formation.

• When dew forms in your camcorder.

Dew will gradually form on the head drum of your camcorder and make the video tape stick to the head. This causes damage both to the head and the tape. When dew forms, recording and playback may not function properly.

Dew is likely to form in the following circumstances:

- When moving the camcorder from a cold place to a warm place.
- When placing the camcorder in a cold room which is then heated rapidly.
- When moving the camcorder outdoors from an air conditioned room or car.
- When placing the camcorder in the direct path of air blowing from an air conditioner.
- When placing the camcorder in a humid room.

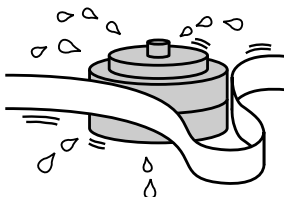

• How to prevent trouble.

When using the camcorder in a place where dew is likely to form, allow the camcorder and the video tape to acclimatise to the surroundings for about one hour.

For example, when bringing the camcorder indoors after skiing, place it in a plastic bag.

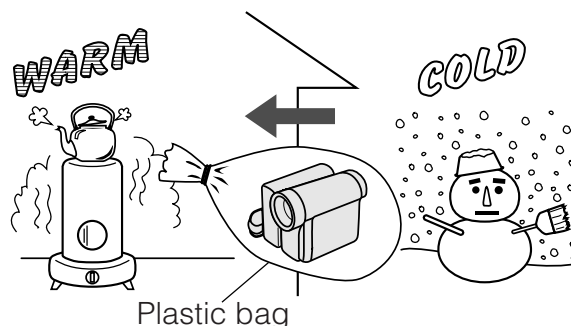

- ① Be sure to tightly seal the plastic bag containing the camcorder.
- ② Remove the bag when the air temperature inside it reaches the temperature of the room.

• “Dew” warning feature

If dew forms, the word “DEW” flashes on the screen, and the power will automatically turn off in approximately 10 seconds.

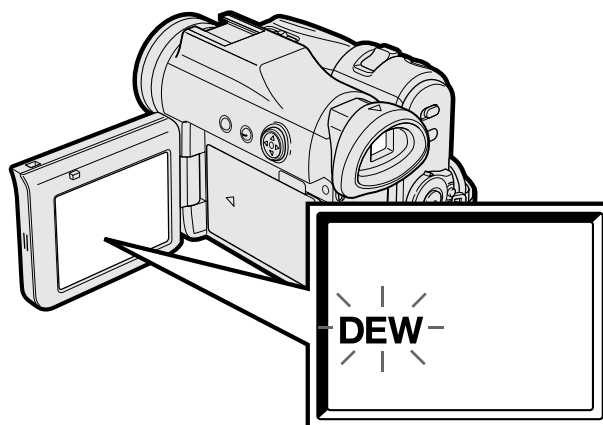

- ① If “DEW” flashes, remove the cassette, leave the cassette compartment open, and wait for a few hours to allow the camcorder to acclimatise to the surrounding temperature.
- ② To use the camcorder again, turn on the power after waiting for a few hours. Be sure that “DEW” has disappeared.
- ③ Do not insert a cassette while “DEW” is flashing; this may result in damage to the tape.
- ④ Since dew forms gradually, it may take 10 to 15 minutes before the dew warning feature engages.

Precautions

Dirty Video Heads

When the video heads have become clogged with dirt (dust and tape coating particles),

Striped noise



Mosaic noise



- mosaic-like noise appears on the playback picture. (See illustrations above.)
- playback pictures do not move.
- during playback, the whole screen becomes blue.

Causes of video head clogging

- High-temperature and high-humidity environment
- A lot of dust in the air
- Damaged tape
- Worn tape
- Long-time use
- Dew formation

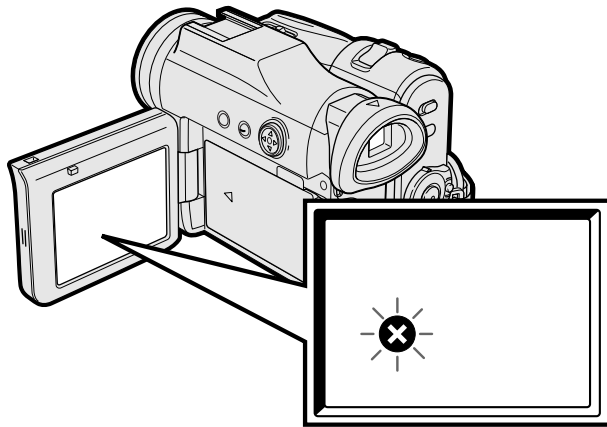

If the video heads become clogged, the  indicator appears on the screen. Contact the nearest SHARP service centre or your dealer for further advice.

Using a Cleaning Tape (Commercially Available)

Available mode:

Tape Playback

You can clean the video head with a commercially available cleaning tape.

Notes:

- Excessive use of the cleaning tape may cause damage to the video heads. Please read the instructions accompanying the cleaning tape carefully before using it.
- The fast forward and rewind functions cannot be used when the cleaning tape is in the camcorder.
- If the video heads again become clogged with dirt soon after cleaning, this might be caused by a damaged tape. In this case, stop using that cassette immediately.

- 1** Insert a cleaning tape into the camcorder.
- 2** Set the camcorder to Tape Playback mode.
 - The video head cleaning screen appears.
- 3** Press  on the Operation button to begin video head cleaning.
 - "NOW CLEANING" flashes during cleaning.

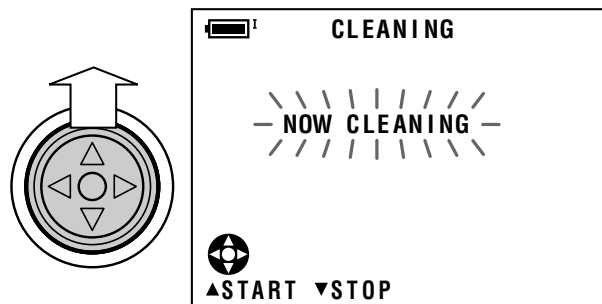

- After about 20 seconds, video head cleaning automatically finishes, and "EJECT THE CASSETTE." displays.

- 4** Remove the cleaning tape.

To cancel cleaning, press .

Operation References

Part Names

For details on the use of each part, refer to the page number indicated in parentheses.

Front view

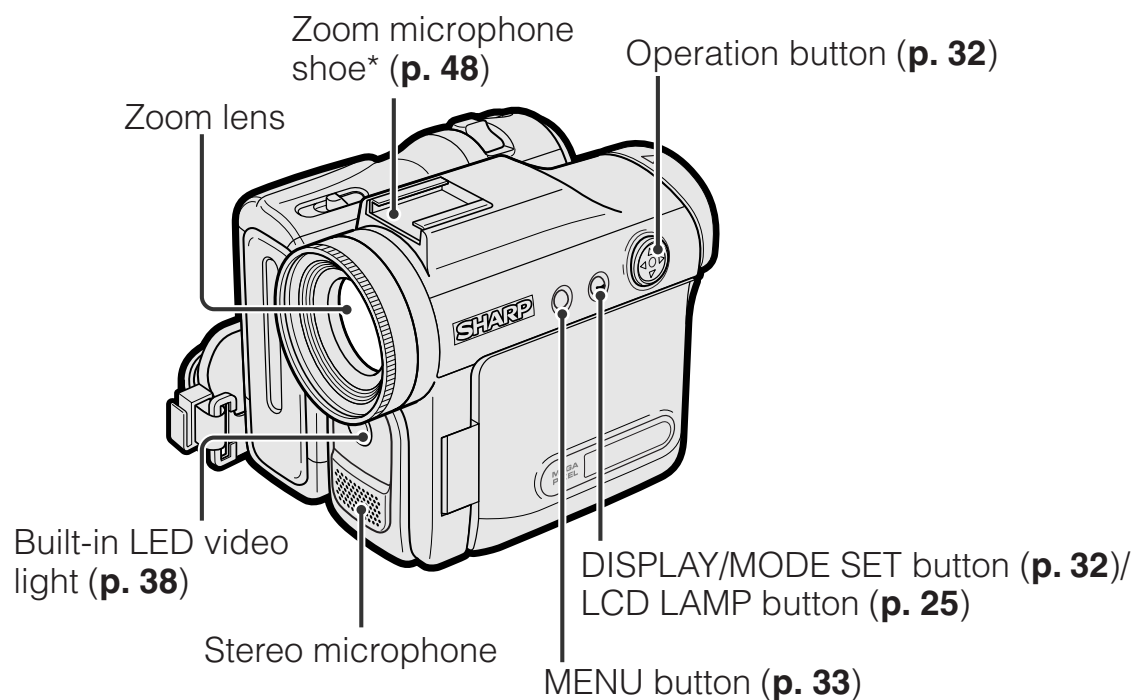

* The zoom microphone shoe is designed only for the optional zoom microphone VR-8MC. Accessories, such as a video light, cannot be used.

Operation References

Left view

Operation References

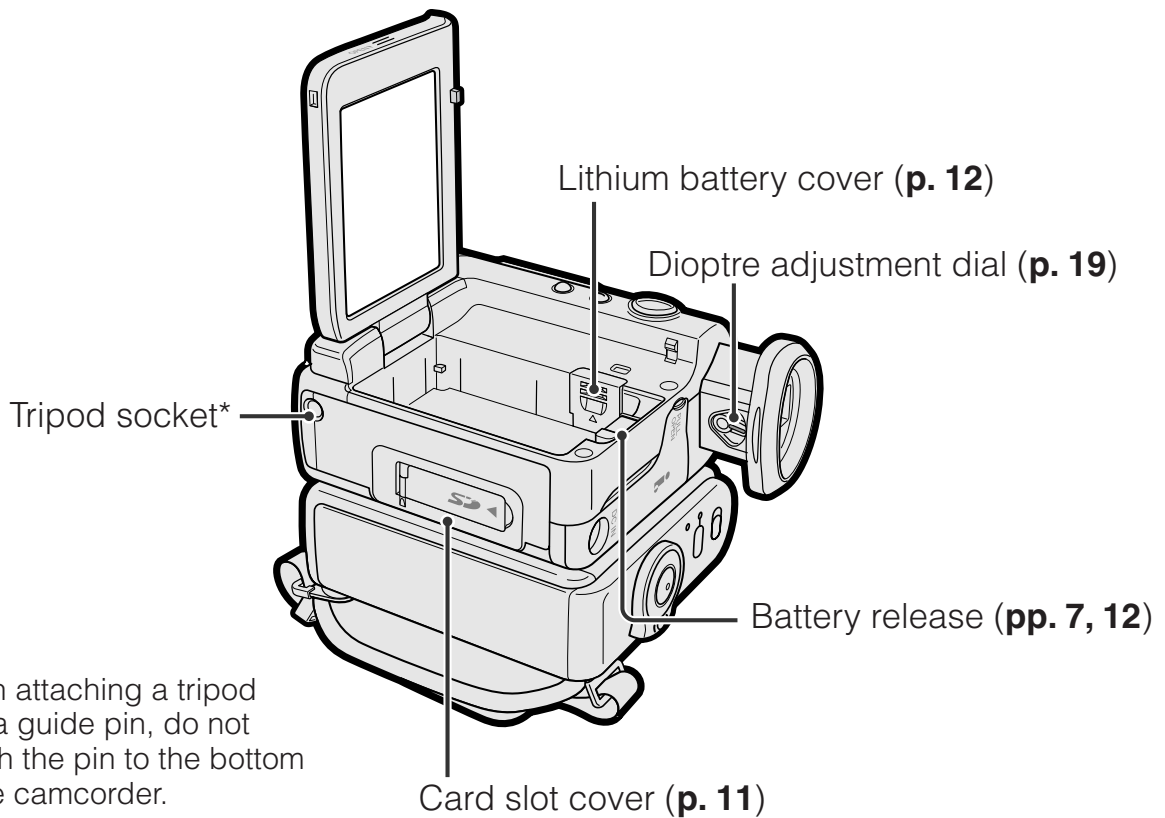
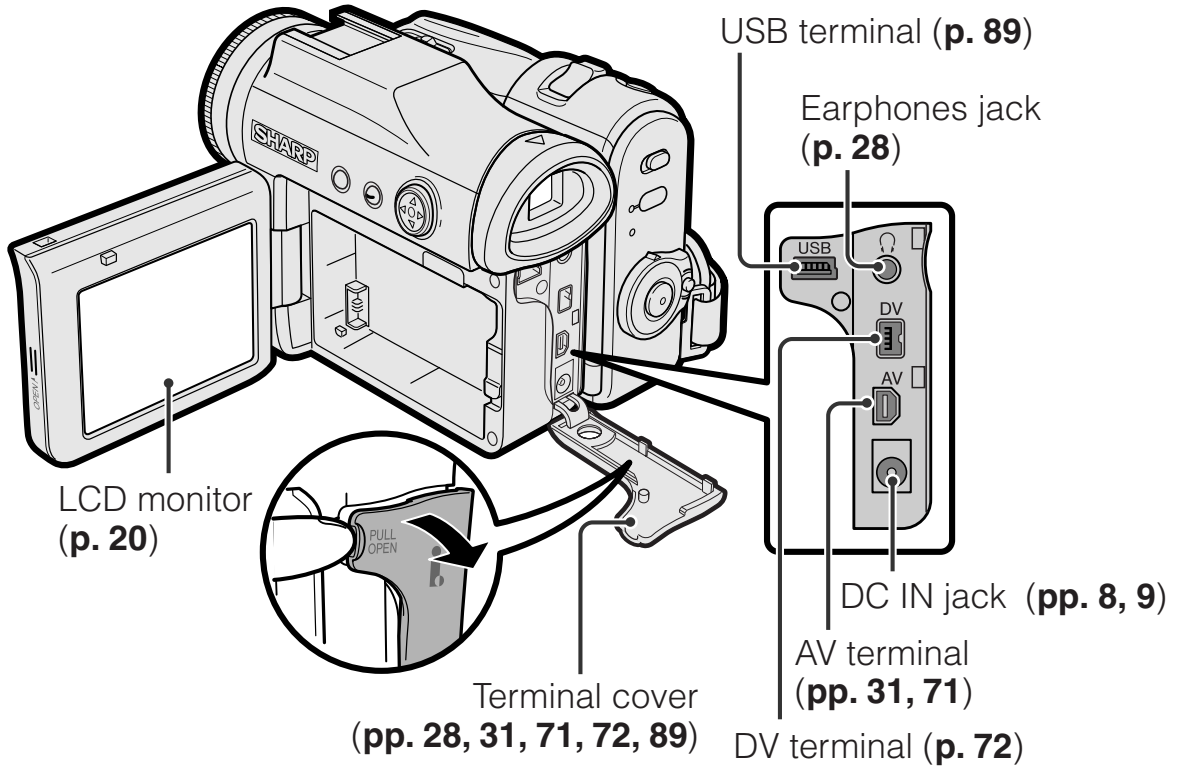

*When attaching a tripod with a guide pin, do not attach the pin to the bottom of the camcorder.

Right view

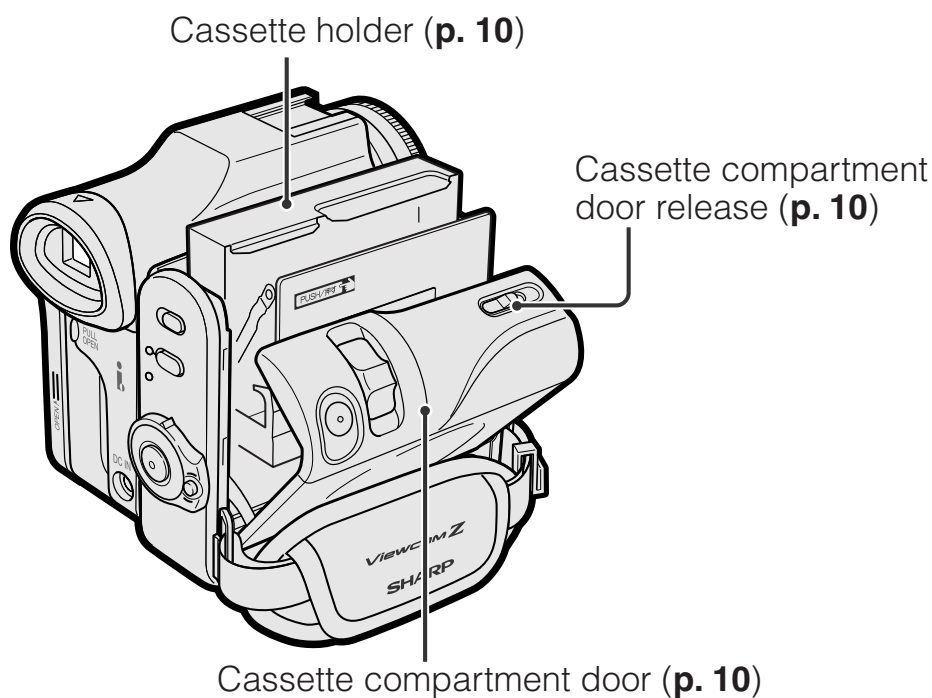
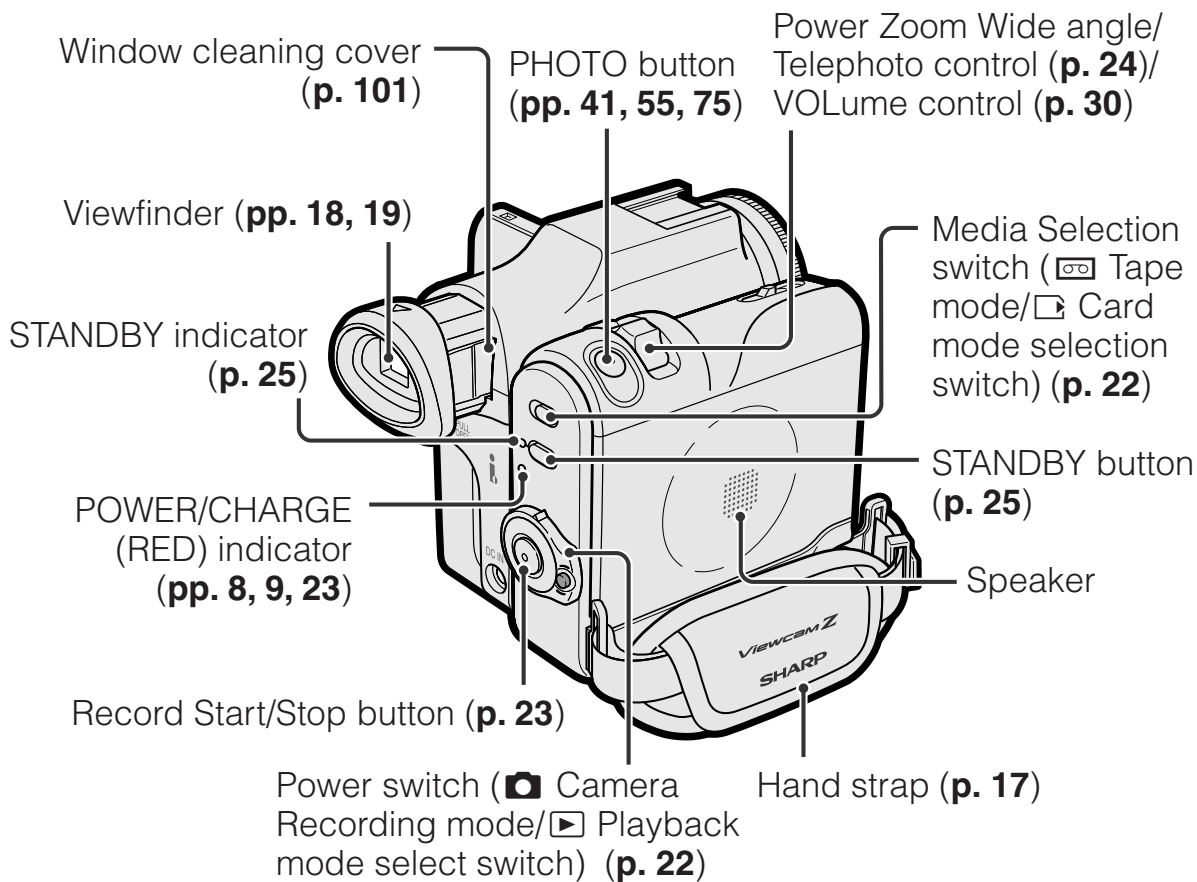

Operation References

Warning Indicators

If a warning indicator appears on the screen, follow the specified instructions.

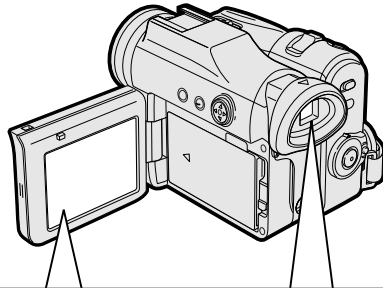

Operation References

Displayed for the first 3 seconds	Displayed after 3 seconds	Description of warning
INSERT A CASSETTE.		There is no video cassette in the camcorder. Insert a cassette (see page 10).
EJECT THE CASSETTE.	EJECT THE CASSETTE.	The video cassette is defective and should be removed (see page 10).
CASSETTE NOT RECORDABLE.		The erasure protect tab on the video cassette has been slid to the record-protect position, preventing recording (see page 98).
THE TAPE ENDS SOON.		The tape is about to end. Prepare a new cassette (see page 10).
CHANGE THE CASSETTE.	TAPE END	The tape has reached the end. Replace it with a new cassette (see page 10).
BATTERY IS TOO LOW.		The battery is almost depleted. Replace it with a fully charged battery pack (see pages 6 and 7).
DEW		Dew has formed inside the camcorder. Wait a few hours for the dew to dry away (see page vii). About 10 seconds after this warning appears, the camcorder automatically turns off.
		The video heads are clogged and should be cleaned (see page viii).
LAMP	LAMP	The fluorescent lamp behind the LCD monitor is close to the end of its service life. Call your local authorized Sharp dealer to have it replaced.
USB	USB	The battery is almost depleted when the camcorder transfers data through the USB cable. Use the AC adapter or fully charged battery pack as the power source (see pages 6-9, 91).

Displayed for 5 seconds	Description of warning
NO MEMORY CARD	The card is not inserted or is inserted improperly. Check that it is properly inserted (see page 11).
MEMORY CARD FULL	The capacity of the card is full and cannot store any more images. Delete unnecessary images (see page 82) or replace the card with a new one (see page 11).
NO DATA ON MEMORY CARD	The card has no images recorded in the format the camcorder can recognize.
MEMORY CARD ERROR	The images in the card are corrupted or recorded in a format which is not compatible with this camcorder. Format the card to use it with this camcorder (see page 78)*.
FORMAT MEMORY CARD	The card has not been formatted with this camcorder. Format the card (see page 78)*.
MEMORY CARD PROTECTED	The card is write-protected (see page 11).
DATA PROTECTED	You are trying to delete a protected image. Cancel the protection setting (see page 81).
MEMORY CARD READ ERROR	The selected image cannot be read by this camcorder. Format the card to use it with this camcorder (see page 78)*.
CANNOT STORE DATA	The card cannot record any data due to a problem with the card or data on the card. Replace the card (see page 11) or format the card (see page 78)*.
PLEASE USE PHOTO BUTTON	The camcorder cannot record with the Record Start/Stop button in Card Recording mode. Press the PHOTO button (see page 75).
MAXIMUM 999 IMAGES	The print order cannot be set to more than 999 images.
MAXIMUM FILE NUMBER	You cannot record any image with a file number bigger than 999–9999. Set FILE NO. menu item to “RESET” (see page 79), then format the card (see page 78)* or replace the card with a new one (see page 11).

* Formatting a card erases all stored images, including delete-protected images. Be sure to backup important data on your computer or other media before formatting the card.

Note:

-  indicates a flashing display.

Preparation

Attaching and Removing the Battery Pack

Attaching

Preparation

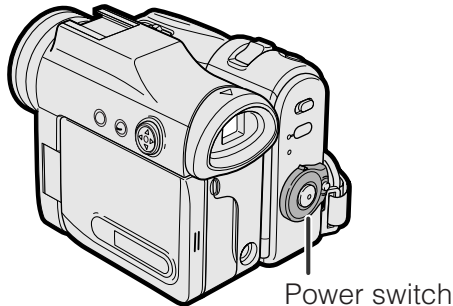

- 1 Make sure that the Power switch is set to OFF.

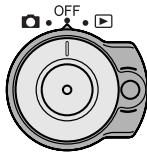

- 2 Open the LCD monitor to a 90° angle to the camcorder body.

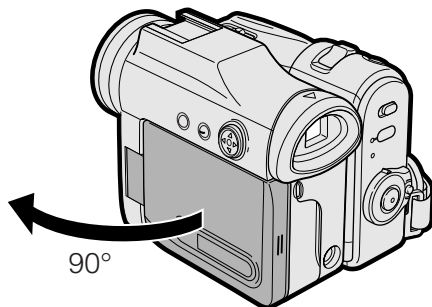

- 3 Slide the battery pack in the direction of the arrow with the "Δ" mark facing out.

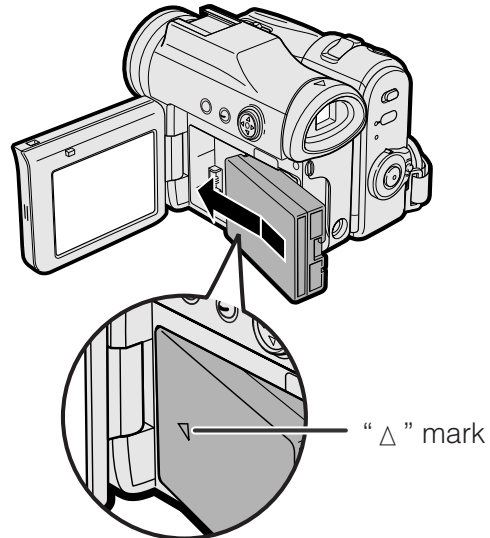

- 4 Push the battery pack in the direction of the arrow until it clicks.

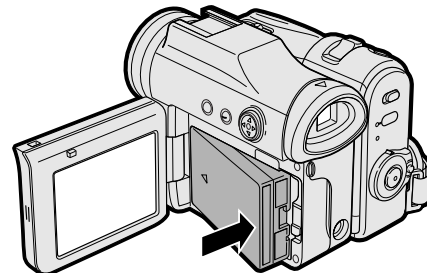

Removing

- 1 Make sure that the Power switch is set to OFF, then open the LCD monitor to a 90° angle to the camcorder body.

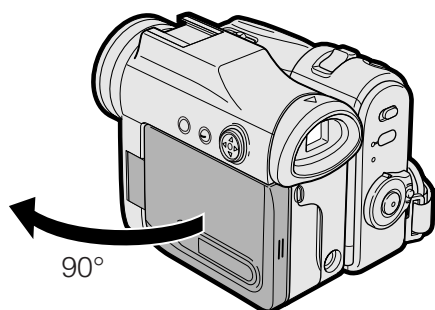

- 2 Slide the battery release in the direction of the arrow.

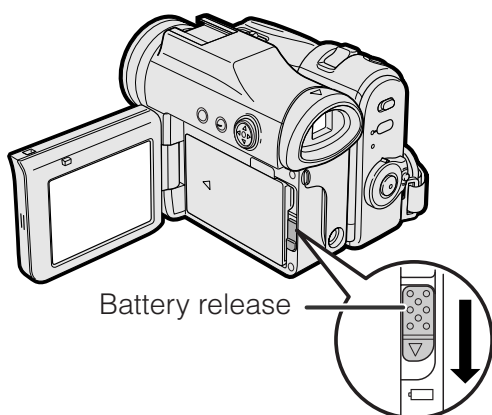

- 3 Take the battery pack out.

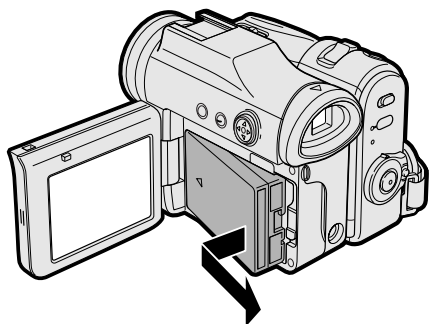

Notes:

- **BEFORE REMOVING THE BATTERY PACK, ALWAYS STOP RECORDING OR PLAYBACK AND TURN THE POWER OFF.**

Removing the battery pack while shooting or during playback may damage the tape by causing it to wrap around the video head drum or destroy the card, rendering it unreadable and unwritable.

- Remove the battery pack from the camcorder if you will not use the camcorder for a long period of time.
- Make sure that the battery pack is firmly attached during operation. If it is not, the battery pack may come off or camcorder operation may fail because of the poor contact pressure.
- To prevent damage to the battery pack when removing, be sure to firmly hold the battery pack while pressing the release.
- Use only SHARP model BT-L227 battery packs with this camcorder. Use of other batteries may create a risk of fire or explosion.
- Before closing the LCD monitor, make sure the battery pack is properly attached to the camcorder, otherwise the monitor may be damaged.

Preparation

Charging the Battery Pack

Preparation

- 1 Attach the battery pack to the camcorder, and make sure that the Power switch is set to OFF.
- 2 Connect the supplied power cord to the AC power socket on the AC adapter, and insert the AC plug into a power outlet.

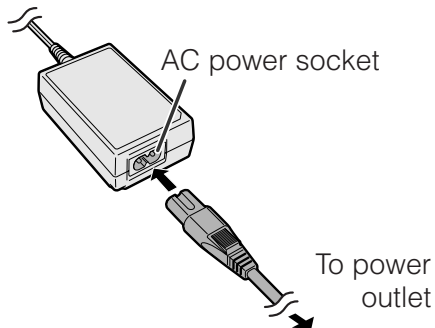

- 3 Insert the DC plug into the DC IN jack of the camcorder.
 - The POWER/CHARGE (RED) indicator lights up red.

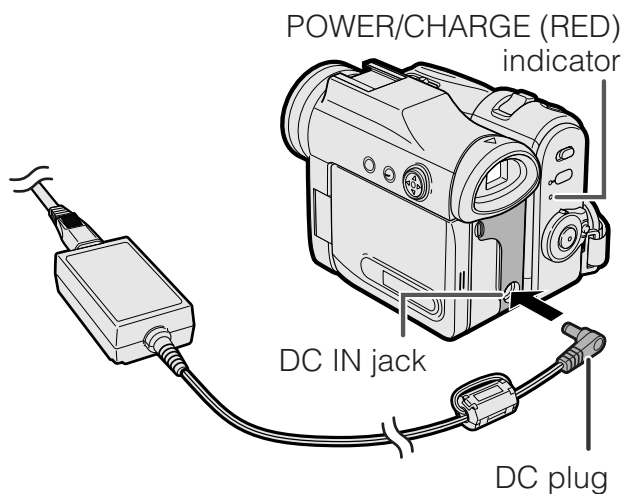

- The POWER/CHARGE (RED) indicator turns off when the battery is charged.

- 4 Remove the DC plug from the DC IN jack, then remove the AC adapter from the power outlet.

Charging time and maximum continuous recording and playback times in Tape modes

Battery pack	Charging time	Max. continuous recording time		Max. continuous playback time on LCD
		LCD closed	LCD open	
BT-L227	120	135	120	120

- The chart specifies the approximate times in minutes.

Notes:

- Charge the battery pack between 10°C and 30°C. The battery pack may not charge properly at temperatures too low or too high.
- The battery pack and AC adapter become warm during charging. This is not a malfunction.
- Using the zoom (see page 24) and other functions or turning the power on and off frequently will increase power consumption. This may result in a decrease in the actual recording time compared to the maximum continuous recording time listed above.
- The charging time and recording time may vary depending on the ambient temperature and the condition of the battery pack.
- See pages 100 and 101 for more information on using the battery pack.
- Charge only SHARP model BT-L227 battery packs. Other types of battery packs may burst, causing personal injury and damage.
- When attaching the supplied audio/video/S-video cable or USB cable, remove the DC plug, open the terminal cover and connect it.

Powering the Camcorder from an AC Outlet

You can also power the camcorder from a power outlet by using the supplied AC adapter.

Note:

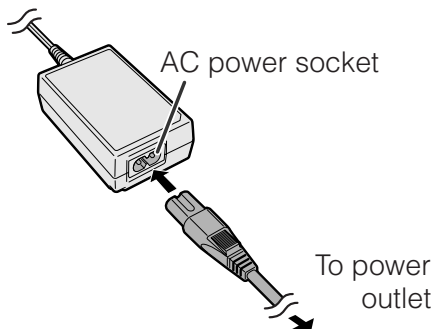

- The supplied AC adapter is specially designed for use with this camcorder, and should not be used as a power supply for other camcorders.

- 1** Make sure that the Power switch is set to OFF.
- 2** Connect the supplied power cord to the AC power socket on the AC adapter, and insert the AC plug into a power outlet.

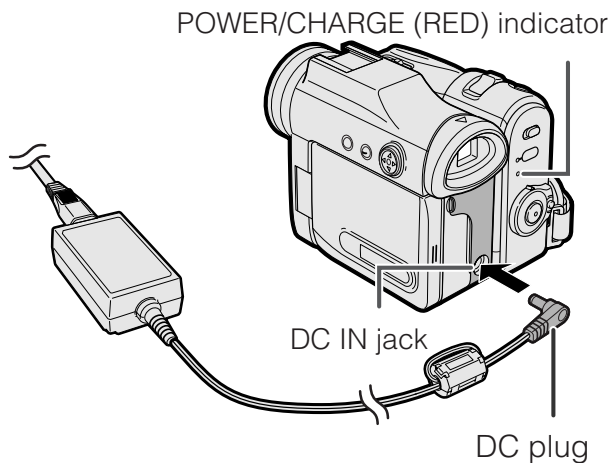

- 3** Insert the DC plug into the DC IN jack of the camcorder.



- 4** Hold down the Lock button and set the Power switch to  or .
 - The POWER/CHARGE (RED) indicator lights up green.

Notes:

- **BEFORE REMOVING THE DC PLUG, ALWAYS STOP RECORDING OR PLAYBACK AND TURN THE POWER OFF.** Removing the DC plug while shooting or during playback may damage the tape by causing it to wrap around the video head drum or destroy the card, rendering it unreadable and unwritable.
- Disconnect the AC adapter from the camcorder if you will not use the camcorder for a long period of time.

Inserting and Removing a Cassette

Inserting

- 1 Attach the power source to the camcorder, then slide and hold the cassette compartment door release as you open the cassette compartment door.

- After confirmation sound, the cassette holder extends and opens automatically.

Cassette compartment door release

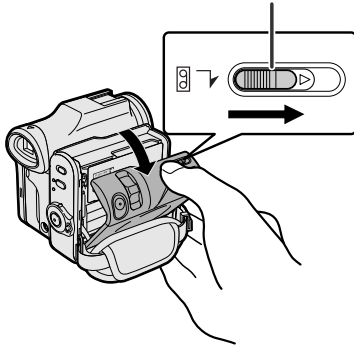

- 2 Insert a commercially available Mini DV cassette fully with the window facing outwards, and with the erasure protect tab facing upwards.

Erasure protect tab

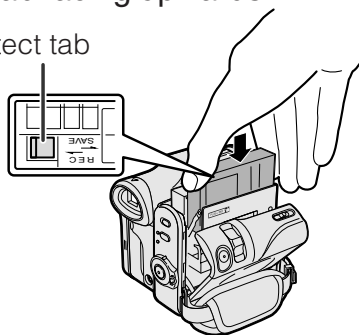

- 3 Press the "PUSH" mark gently until the cassette holder clicks into place.

- The cassette holder retracts automatically.

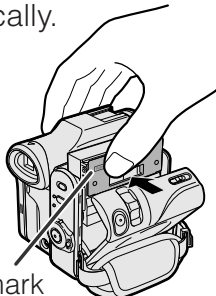

- 4 Wait for the cassette holder to fully retract. Close the compartment door by pressing its centre until it clicks into place.

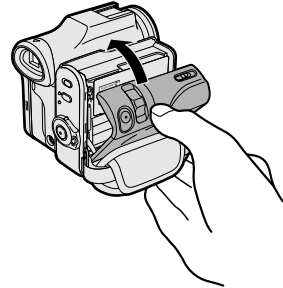

Removing

Perform step 1 above, then take out the cassette.

Notes:

- Do not try to close the cassette compartment door while the cassette holder is extending or retracting.
- Be careful not to get your fingers caught in the cassette holder.
- Do not apply force to the cassette holder except when pressing the "PUSH" mark to close it.
- Do not tilt the camcorder or hold it upside down when you are inserting or removing a cassette. It may damage the tape.
- Remove the cassette if you will not use the camcorder for a long period of time.
- If you do not correctly close the cassette holder in step 3, the cassette protection mechanism of the camcorder might eject the cassette. If this happens, repeat the insertion procedure.
- Do not attempt to pick up the camcorder by the cassette compartment door.
- If the battery power is too low, you may not be able to eject the cassette. Replace the battery pack with a fully charged one.
- You can only use Mini DV cassettes. Large DV cassettes cannot be used. Be sure to use Mini DV cassettes with the ^{Mini}DV mark.
- See pages 97 and 98 for more information on the video cassette tapes intended for use with this camcorder.

Inserting and Removing a Card

You can use an SD Memory Card (supplied) or a MultiMediaCard (commercially available) for storing still images.

Inserting

- 1 Make sure that the Power switch is set to OFF.
- 2 Open the card slot cover.

Card slot cover

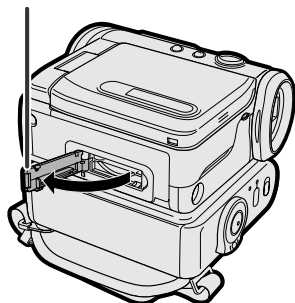

- 3 Insert a card into the slot as shown below, and push it in fully.

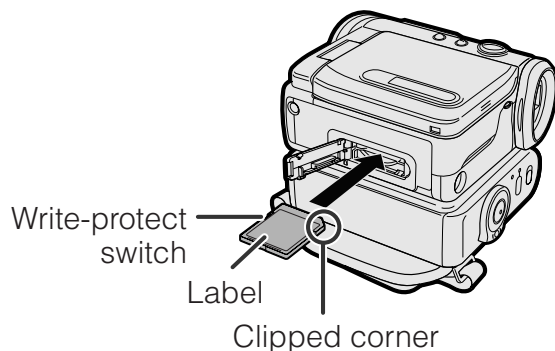

- 4 Close the card slot cover securely.

Removing

Perform steps 1 and 2 above, push the card and release slowly (①). Then pull the card straight out (②) as shown below.

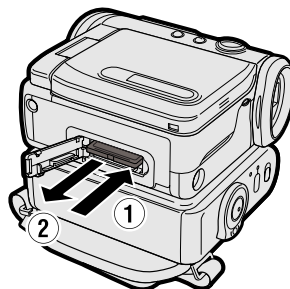

Notes:

- You can use only the SD Memory Card or the MultiMediaCard (see page 99).
- The supplied card is preformatted for immediate use.
- See page 99 for more information on the cards intended for use with this camcorder.
- **Do not remove the card from the camcorder while recording data on the card (⏏ indicator flashes during recording). This may delete the recorded image or damage the card.**
- **You cannot insert or remove the card when using a tripod.**

About the write-protect switch

SD Memory Card has a write-protect switch. When the switch is set to the locked position, you cannot record/delete data or format the card. Set it to the unlocked position to record/delete data or format the card.

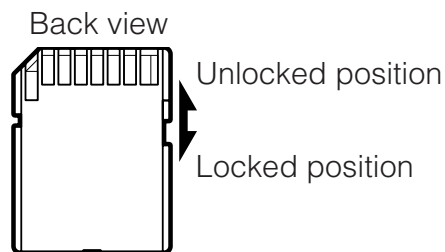

Preparation

Installing the Lithium Batteries

Installing the Memory Battery

The supplied CR1216 type lithium battery is used to store the memory of the date and time settings.

- 1 Make sure that the Power switch is set to OFF.
- 2 Open the LCD monitor to a 90° angle to the camcorder body.
- 3 Slide the battery release in the direction of the arrow, then take the battery pack out.

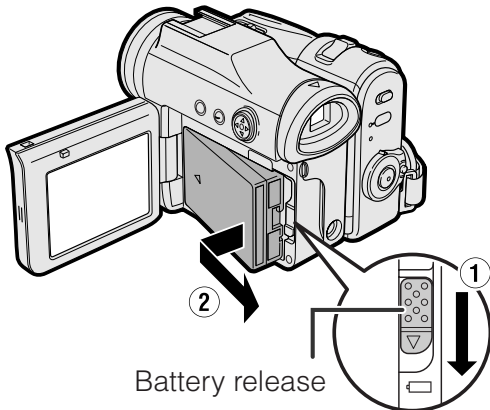

- 4 Pull out the lithium battery cover in the direction of the arrow.

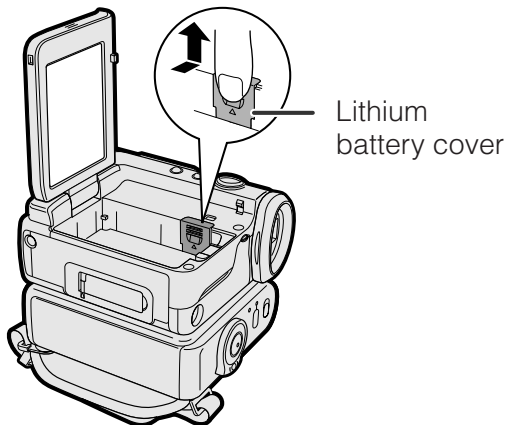

- 5 Insert the smaller lithium battery into the compartment with the + side of the battery facing out.

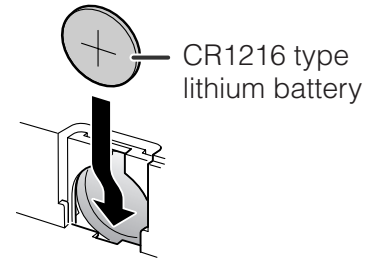

- 6 Close the lithium battery cover firmly until it clicks into place.

Removing the Memory Battery

Perform steps 1 to 4 above, then lift out the battery by using a pointed object such as the tip of a ballpoint pen.

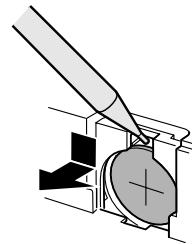

Installing the Battery to Remote Control

The supplied CR2032 type lithium battery is used to power the remote control unit.

- 1 Insert a pointed object such as the tip of a ballpoint pen to open the battery holder.

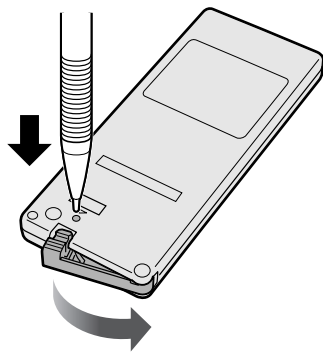

- 2 Place the larger lithium battery on the battery holder with the + side facing down.

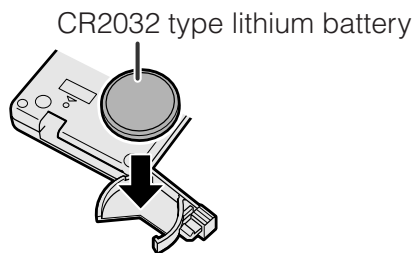

- 3 Close the battery holder until it clicks.

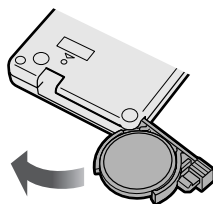

Notes on the Use of the Lithium Battery

CAUTION: Danger of explosion if battery is incorrectly replaced. For camcorder, replace only with same or equivalent type CR1216, for remote control unit, replace only with same or equivalent type CR2032, both recommended by the equipment manufacturer.

WARNING KEEP THIS BATTERY AWAY FROM CHILDREN. IF SWALLOWED, CONSULT A PHYSICIAN IMMEDIATELY FOR EMERGENCY TREATMENT.

CAUTION BATTERY MAY EXPLODE IF MISUSED OR INSTALLED WITH POLARITY REVERSED. DO NOT RECHARGE, DISASSEMBLE OR DISPOSE OF IN FIRE.

- Do not short-circuit, recharge, disassemble, or heat the lithium battery.
- Should the lithium battery leak, wipe the battery compartment clean, and then insert a new battery.
- The lithium batteries will last about one year under normal usage.

Preparation

Selecting the Language for the On-screen Display

Available modes:

All modes

This camcorder allows you to choose English, German or French as the on-screen display language.

Preparation

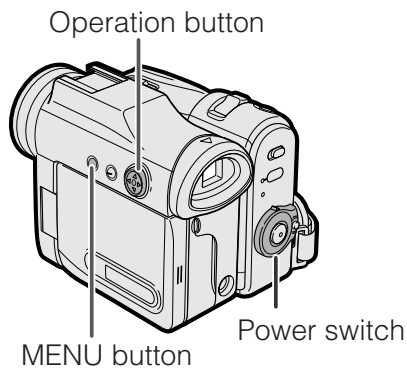

Setting

When using the camcorder for the first time, select your on-screen display language by following the steps below.

- 1 Hold down the Lock button and set the Power switch to .
 - The language selection screen appears.
- 2 Press ∇ or \triangle on the Operation button to select the desired language, then press the centre of the Operation button.

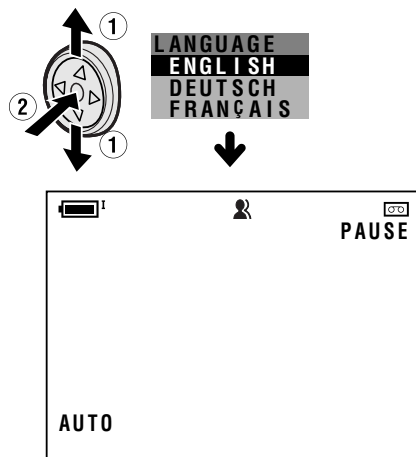

Changing

- The example screens shown are for Tape Camera mode.

- 1 Press the MENU button to display the menu screen.
- 2 Press ∇ or \triangle to select \checkmark 1, then press the centre of the Operation button.
- 3 Press ∇ or \triangle to select “LANGUAGE” (“SPRACHE” or “LANGUE”), then press the centre of the Operation button.
 - The language selection screen appears.

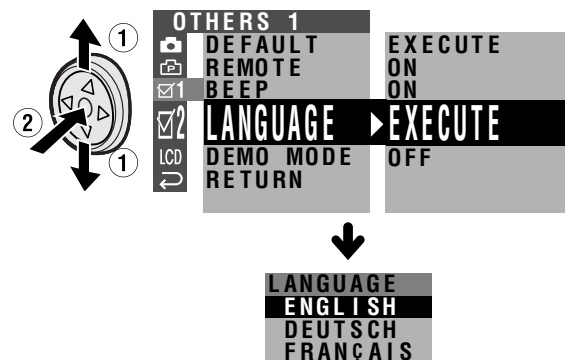

- 4 Press ∇ or \triangle to select the desired language, then press the centre of the Operation button.
 - The menu screen displays in the language selected.

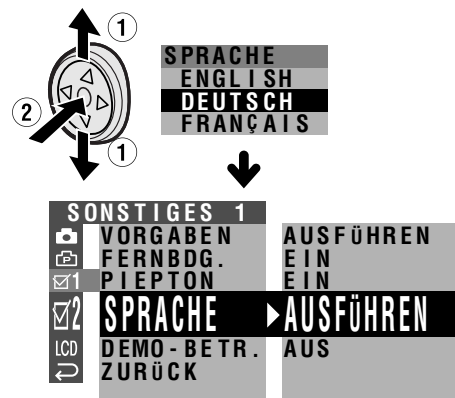

- 5 Press the MENU button to turn off the menu screen.

Note:

- The English, German and French portions of this operation manual are based on the use of on-screen displays in their respective languages. The portions of this manual in other language, however, are based on the use of English on-screen displays.

Setting the Date and Time

Available modes:
All modes

Example: Setting the date to 2 June 2005 (2. 6. 2005) and the time to 10:30 am (10:30).

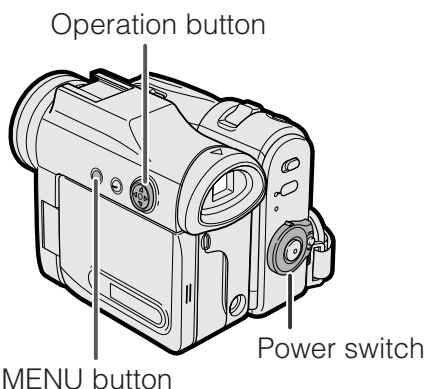

Note:

- Before performing the steps below, make sure that the CR1216 type lithium battery has been installed (see page 12).
- The example screens shown are for Tape Camera mode.

1 Hold down the Lock button and set the Power switch to or .

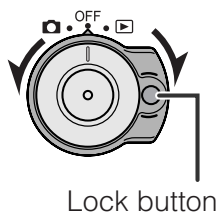

2 Press the MENU button to display the menu screen.

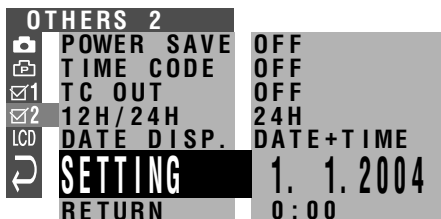

3 Press the centre of the Operation button.



4 Press Δ or ∇ to select "2" (day), then press the centre of the Operation button.



5 Press Δ or ∇ to select "6" (month), then press the centre of the Operation button.



6 Press Δ or ∇ to select "2005" (year), then press the centre of the Operation button.



7 Press Δ or ∇ to select "10" (hour), then press the centre of the Operation button.



8 Press Δ or ∇ to select "30" (minute), then press the centre of the Operation button.



- The internal clock now starts operating with the seconds display.

9 Press the MENU button to turn off the menu screen.

Note:

- If the date and time have been set, the SETTING 1 screen () appears in step 2. Select "SETTING" in the OTHERS 2 screen (2) using the Operation button.

Preparation

Preparation

Changing to the 12-hour Time Mode

- 1 After performing step 8 on the previous page, press ∇ or Δ to select "12H/24H", then press the centre of the Operation button.

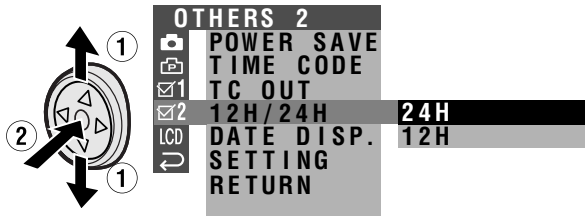

- 2 Press ∇ or Δ to select "12H", then press the centre of the Operation button.

12H/24H **12H**

- 3 Press the MENU button to turn off the menu screen.

Notes:

- The date and time, once set, are internally recorded even when not displayed on the screen.
- The menu screen automatically turns off if no settings are made within 5 minutes.

Using the Lens Cap

Attach the strap of the lens cap to the hand strap as shown below.

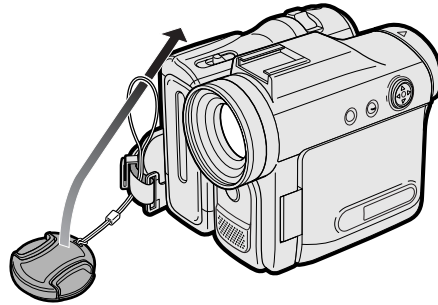

When attaching or removing the lens cap, grasp the indents on both sides of the cap.

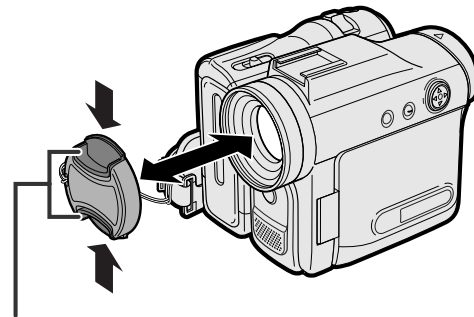

Indents

When recording, remove the lens cap and attach the lens cap cord to the fastener so that the cap will not get in the way.

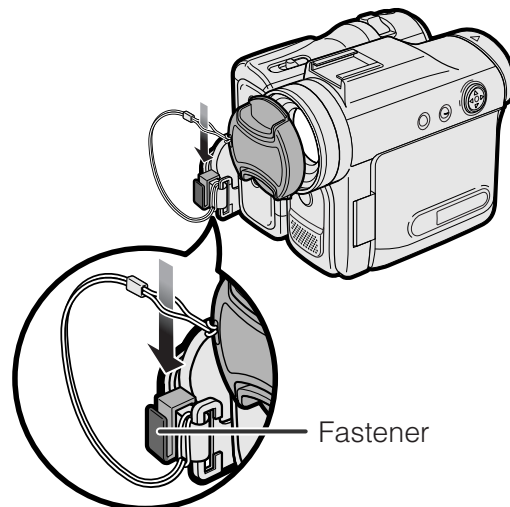

Fastener

Note:

- Always attach the lens cap over the lens when not using the camcorder.

Adjusting the Hand Strap

- 1 Open the hand strap flap (①) and grip strap (②).

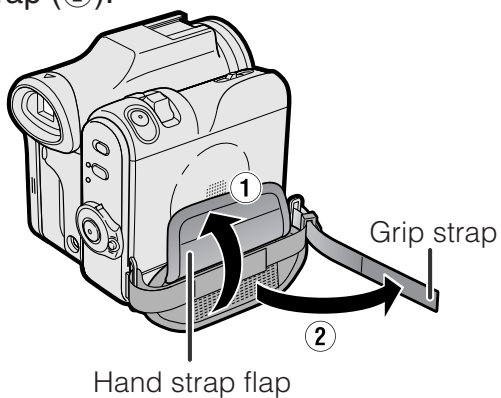

- 2 Loosen the grip strap, pass your right hand through the hand strap, and put your thumb close to the Record Start/Stop button and your index finger on the Power Zoom control. Then, pull the grip strap tight until it fits snugly.

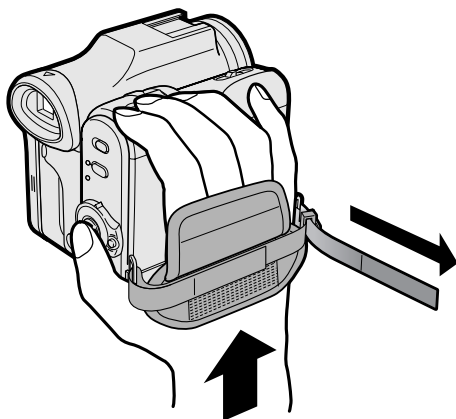

- 3 Seal the Velcro® fasteners of the grip strap and the hand strap flap.

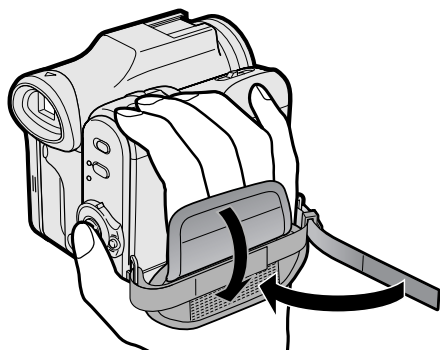

Using the Grip

Rotate the grip 135° forward or 105° downward so that you can record images easily from high or low angle (see page 21).

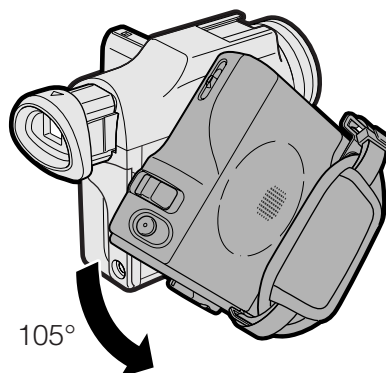
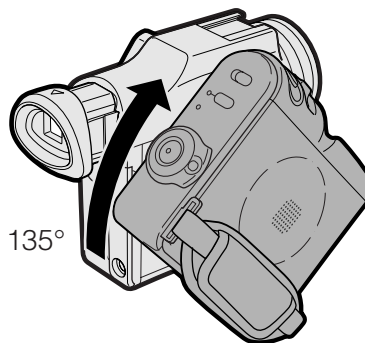

Note:

- The grip cannot rotate when a tripod is attached.

Preparation

Detaching the Lens Hood

Before using a commercially available conversion lens, detach the lens hood as shown below.

Preparation

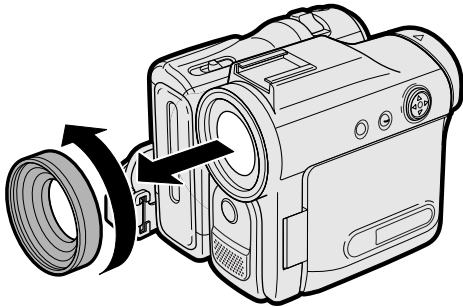

Note:

- You cannot attach the supplied lens hood or lens cap to a conversion lens.

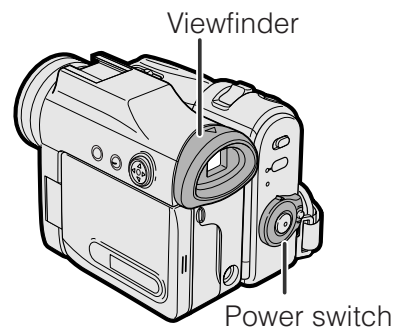

Using the Viewfinder

You can record the subject using the electronic viewfinder. You can also watch playback through the viewfinder.

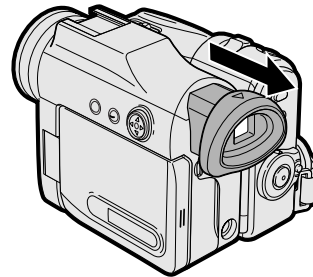

- 1 Pull out the viewfinder completely.



- 2 Hold down the Lock button and set the Power switch to  or .

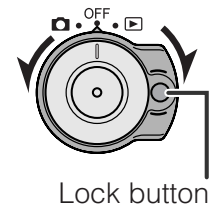

Closing the viewfinder

Push in the viewfinder completely.

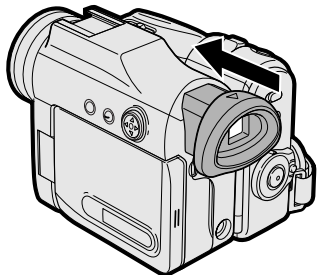

Notes:

- Do not use excessive force when moving the viewfinder.
- Do not pick up the camcorder by the viewfinder.
- The viewfinder automatically turns off when the LCD monitor is opened. If the vertical rotation of the monitor is 180° when in Tape Camera or Card Camera mode, however, the viewfinder is on and the subject is displayed both in the viewfinder and on the monitor (see page 44).
- You can adjust the settings on the MENU screen through the viewfinder by using the Operation button (see page 32 for use of the Operation button).
- Be sure to close the viewfinder after use.

Adjusting the dioptre

Adjust the dioptre according to your eyesight when the picture in the viewfinder or the characters on the on-screen display is not clear.

- 1 Pull out the viewfinder completely.
- 2 Hold down the Lock button and set the Power switch to .
- 3 While looking through the viewfinder, turn the dioptre adjustment dial until the indicators in the viewfinder are clearly visible.

Dioptre adjustment dial

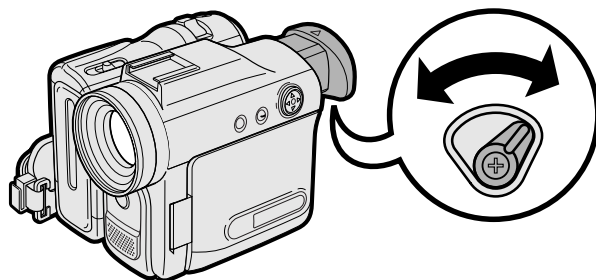

Note:

- For cleaning the viewfinder, see page 101.

Preparation

Using the LCD Monitor

You can use the LCD monitor to play back recordings that you have made or to watch the subject during recording.

Preparation

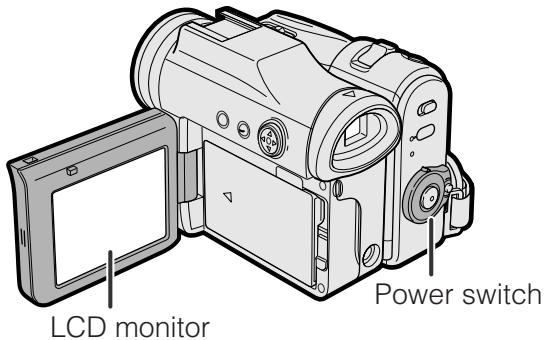

- 1 Open the LCD monitor to a 90° angle to the camcorder body.

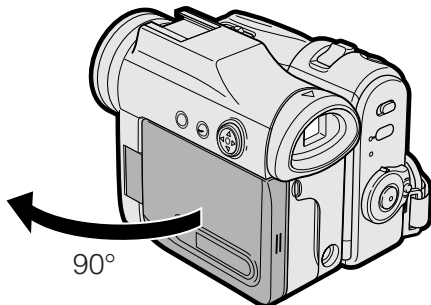

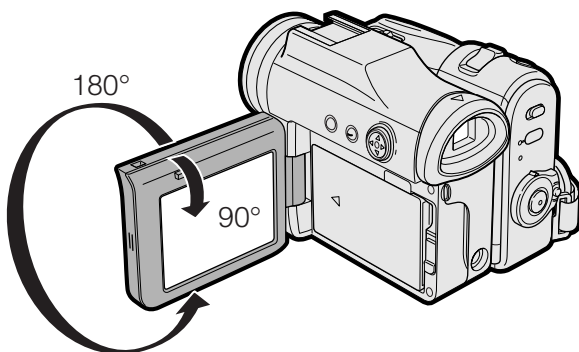

- 2 Adjust the LCD monitor to an angle that allow easy viewing of the on-screen picture.
 - The LCD monitor rotates 270° vertically.

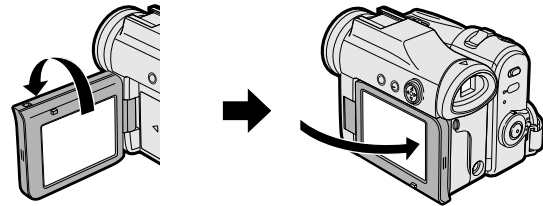

Note: Do not try to rotate the LCD monitor vertically until the monitor is completely opened.

- You can also fold the LCD monitor into the camcorder with the screen facing out for watching playback on the monitor.



- 3 Hold down the Lock button and set the Power switch to  or .

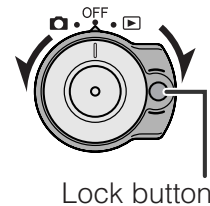

- A picture displays on the LCD monitor.

Note:

- Battery consumption is larger when the LCD monitor is opened. Use the viewfinder instead of the LCD monitor when you want to save the battery power.

Closing the LCD monitor

Return the LCD monitor to the vertical 90° position with the screen facing in, and fold it into the camcorder into place.

Notes:

- Do not use excessive force when moving the LCD monitor.
- When closing the LCD monitor, do not tilt it; otherwise the monitor may not close properly and may become damaged.
- Do not pick up the camcorder by the LCD monitor.
- Do not place the camcorder with the LCD monitor screen facing down.
- Close the LCD monitor completely with the screen facing in when not in use.
- Before closing the LCD monitor, make sure the battery pack is properly attached to the camcorder, otherwise the monitor may be damaged.
- When carrying the camcorder in a bag, for example, close the LCD monitor with the screen facing in.

Tips on Recording Positions

To create images that are easy to watch during playback, try to record with an upright posture and steady hands to prevent a shaky image.

Holding the camcorder

Put your right hand through the hand strap, and place your left hand under the camcorder for support.

Basic posture

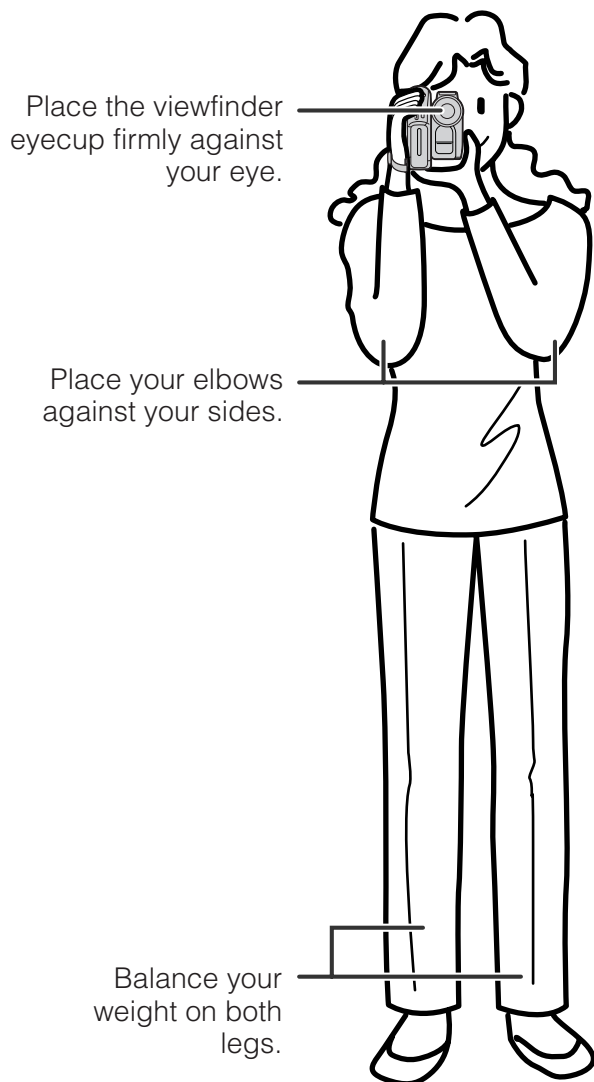

Shooting from a high angle

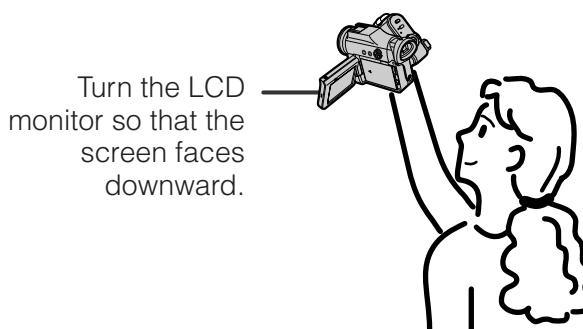

Shooting from a low angle

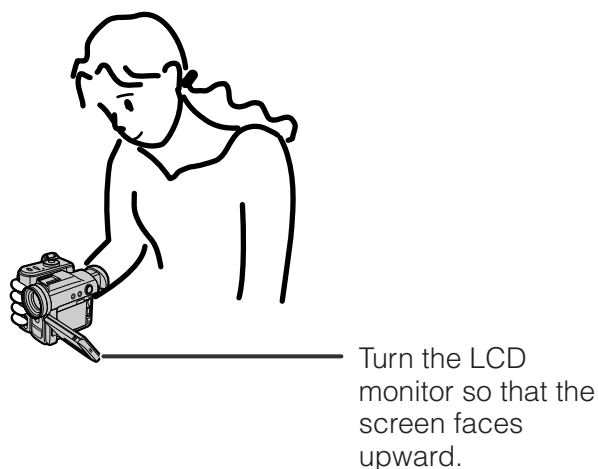

Note:

- Take care not to touch the microphone with your fingers during recording. It will cause noise on the audio track.

Basic Operations

Camera Recording

Selecting the Camcorder Mode

This camcorder includes functions for use as both a video camera for recording and playing back images on tapes and as a digital still camera for recording and playing back still images on cards. One of the following camcorder modes needs to be set before starting any operation.

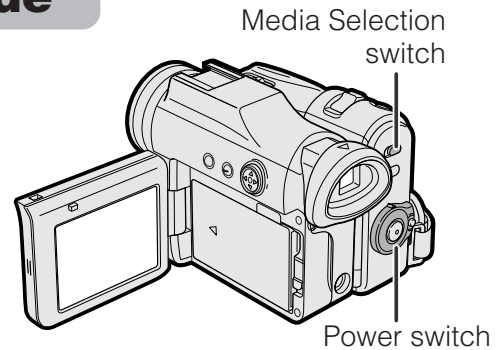

Camcorder modes

Tape Camera mode

For recording motion and still images on a tape.

1 Set the Media Selection switch to .

2 Hold down the Lock button and set the Power switch to .

Lock button

Tape Playback mode

For playing back or editing motion and still images recorded on a tape.

1 Set the Media Selection switch to .

2 Hold down the Lock button and set the Power switch to .

Lock button

Card Camera mode

For recording still images on a card.

1 Set the Media Selection switch to .

2 Hold down the Lock button and set the Power switch to .

Lock button

Card Playback mode

For playing back still images recorded on a card.

1 Set the Media Selection switch to .

2 Hold down the Lock button and set the Power switch to .

Lock button

Notes:

- To turn the power off, set the Power switch to OFF without pressing the Lock button.
- Do not change the camcorder mode by operating the Media Selection switch during recording or playback, as this may cause damage to the tape or card.

Easy Camera Recording on Tape in Full Auto Mode

Available mode:
Tape Camera

- Before you start recording, perform the operations described on pages 6 through 21 to prepare your camcorder for recording.

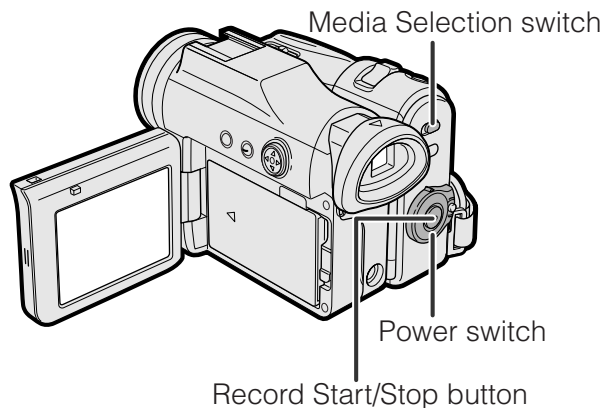

- 1 Remove the lens cap.
- 2 Set the Media Selection switch to .
- 3 Hold down the Lock button and set the Power switch to .
 - The picture from the lens now displays and the POWER/CHARGE (RED) indicator lights up green.
 - The camcorder is now ready to record (Recording Standby mode).

POWER/CHARGE (RED) indicator

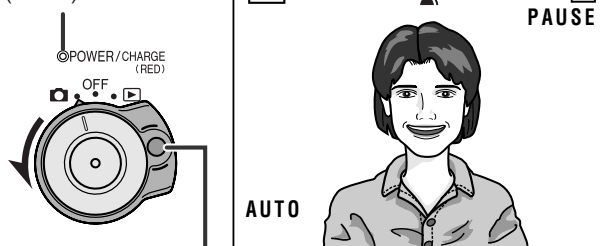

Lock button

Note:

- If "AUTO" is not displayed at this time, set the camcorder to Full Auto mode (see page 64).

- 4 Press the Record Start/Stop button to begin recording.

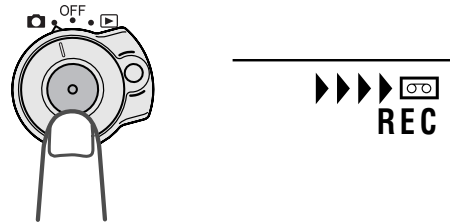

Note:

- Before recording an important scene, please perform the recording test, then playback to check if the scene was recorded properly. If noise occurs, use a commercially available cleaning tape to clean the video heads (see page viii).

Maximum continuous recording and actual recording times in Tape Camera mode

Battery pack	Max. continuous recording time		Actual recording time	
	LCD closed	LCD open	LCD closed	LCD open
BT-L227	135	120	65	60

- The chart specifies the approximate times in minutes.

Note:

- Using the zoom (see page 24) and other functions or turning the power on and off frequently will increase power consumption. This may result in a decrease in the actual recording time compared to the maximum continuous recording time listed above.

Basic Operations

Camera Recording

To pause recording

Press the Record Start/Stop button again. Recording pauses, and the camcorder enters Recording Standby mode.

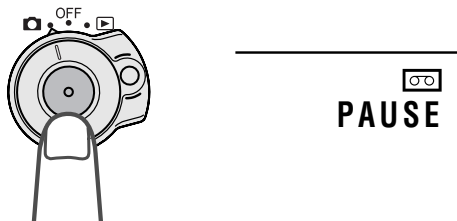

To turn the power off

Set the Power switch to OFF without pressing the Lock button.

Remaining in Recording Standby mode for 5 minutes

If the camcorder remains in Recording Standby mode over 5 minutes in Tape Camera mode, the camcorder automatically enters stop mode to protect the tape from damage.

— To resume Recording Standby mode from stop mode, press the STANDBY button (see page 25).

— To resume recording from stop mode directly, press the Record Start/Stop button. However, it may need several seconds to resume recording after pressing the Record Start/Stop button.

Zooming

Available modes:

Tape Camera, Card Camera

Zooming allows you to move visually closer to or further from a subject without physically changing your position.

When using the optical zoom, you can enlarge the subject up to 10×.

Zooming in (when you want to centre attention on the subject)



Zooming out (when you want to include the surroundings)

Zooming in

Push the Power Zoom control to the T (telephoto) side to get a close-up view (①).

Zooming out

Push the Power Zoom control to the W (wide angle) side to get a wide field of view (②).

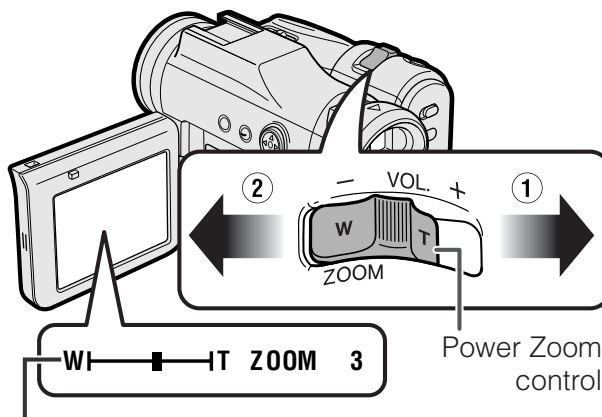

Zoom range indicator

- The zoom range indicator shows you the current zoom setting.
- The zoom speed depends on how far you push the Power Zoom control.

Notes:

- The camcorder is unable to focus when zooming in on subjects closer than 1.5 m.
- See page 34 for how to use the digital zoom.

Power Standby Mode

Available mode:

Tape Camera

Power Standby mode allows you to prevent accidental recording by locking all operations except cancelling the mode.

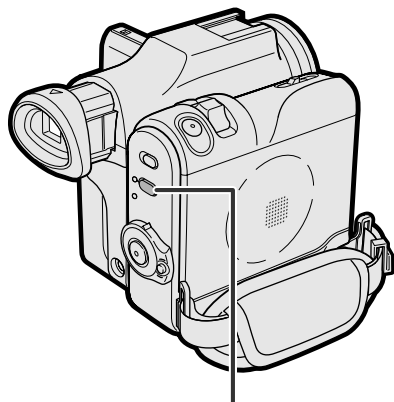

STANDBY button

Hold down the STANDBY button for more than 2 seconds when you pause recording in Tape Camera mode.

- The screen turns off and the STANDBY indicator lights up.

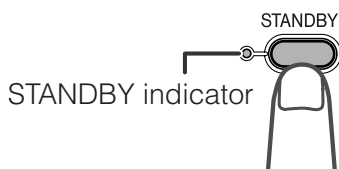

To resume operation

Press the STANDBY button again to return to the Recording Standby mode.

- It takes about 2 seconds to be able to start recording.

Notes:

- Power Standby will cancel and the STANDBY indicator will turn off in these situations below:
 - When the camcorder remains in Power Standby mode for more than 5 minutes
 - When the camcorder is set to Card Camera, Tape Playback or Card Playback mode
 - When removing the battery pack
 - When removing a cassette

- The camcorder will enter stop mode automatically 5 minutes after setting Power Standby mode if it remains in Recording Standby mode after cancelling Power Standby mode.

— When Power Standby mode, for example, is cancelled after 3 minutes, the camcorder will enter stop mode if recording is not started within 2 minutes.

Turning on/off the Backlight

Available modes:

All modes

You can see the on-screen display outdoors on a sunny day or in a location with bright lighting even when the backlight turns off. Also, this function is useful when watching playback on a TV.

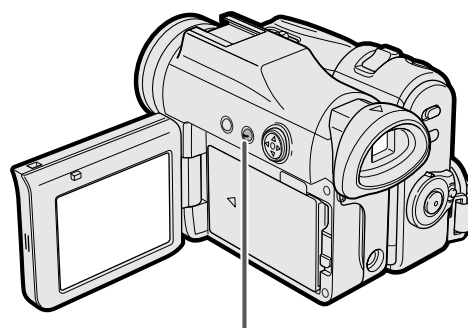

LCD LAMP button

Hold down the LCD LAMP button for more than 2 seconds to turn off the backlight.

-  will flash for 2 seconds, then lights up.

To turn on the backlight

Hold down the LCD LAMP button for more than 2 seconds.

Note:

- The backlight off mode will cancel when you close the LCD monitor.

Basic Operations

Camera Recording

Auto Focus

Available modes:

Tape Camera, Card Camera

The camcorder is preset to Auto Focus mode, which is designed to focus on most types of subjects. In Auto Focus mode, the camcorder automatically focuses on the subject in the centre of the scene. Always keep the subject in the centre of the scene.

Notes:

- If no subject is in the centre of the scene, the focus area will expand and the subject nearest the centre will be focused on.
- Auto Focus may not work in the situations described on page 57. In these situations, use the manual focus function.
- The camcorder may not be able to focus correctly if the subject is closer than approximately 1.5 m. Set the zoom control to wide angle, and try refocusing again.
- If the lens is dirty or fogged, the camcorder may not be able to focus correctly.

Macro Shots

Available modes:

Tape Camera, Card Camera

This camcorder lets you shoot close-up images of small objects such as flowers and insects, or make title frames for your videos. When you want to record a magnified image of a subject which is within approximately 1.5 m of the camcorder, do not zoom in on it. Instead, zoom out all the way by pushing the Power Zoom control to the W side, and then move the camcorder closer to the subject until you obtain the desired angle of view. The camcorder will automatically focus on the subject when the lens is set for the widest angle.

Note:

- When you are recording a macro shot, be sure that the subject receives sufficient illumination.

Remaining Recording Time Display

Available mode:

Tape Camera

When the camcorder is recording in Tape Camera mode, an on-screen indicator displays the approximate remaining tape time in minutes.

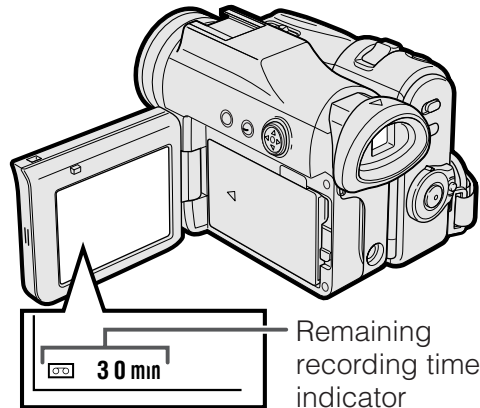

Notes:

- The remaining recording time indicator appears when the on-screen indicators are turned on.
- The remaining recording time indicator appears 10 seconds after pressing the Record Start/Stop button to begin recording.
- The remaining recording time indicator only shows the approximate time left. Also, it varies slightly depending on the length of the tape used. (This function is based on the DVM60 tape standard.)

When the remaining recording time reaches 1 minute, a warning indicator will appear. Prepare a new cassette.

Warning indicator	Approx. remaining time
THE TAPE ENDS SOON. ↓ -TAPE END-	Less than 1 min.
CHANGE THE CASSETTE. ↓ TAPE END	The tape has reached the end.

Remaining Battery Power Display

Available modes:

All modes

When using the camcorder with the battery pack as the power source, the remaining battery power indicator is displayed. If the battery power becomes very low, a warning indicator appears. Replace the battery pack.

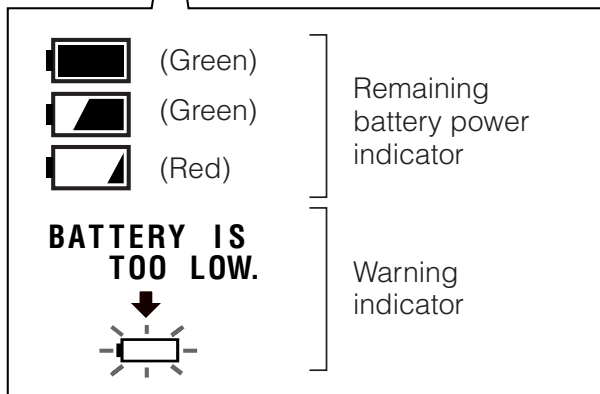
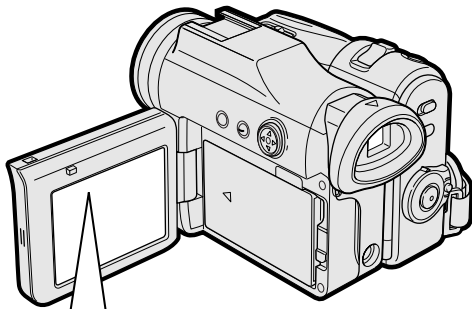

Notes:

- **The remaining battery power indicator appears when the on-screen indicators are turned on.**
- Use the remaining battery power indicator only as an approximate indication.
- The remaining battery power indicator may change to either a higher or lower level if you set the Power switch to OFF and then back to or .
- In cold environments, the red remaining battery power indicator may appear sooner.
- Use of the zoom functions when the warning indicator is displayed may cause the camcorder to suddenly lose power.

Information Display for Battery Usage

Available modes:

All modes

When the camcorder operates with the battery pack, the battery usage indicator appears beside the remaining battery power indicator.

Battery usage indicator for the battery pack attached to the camcorder

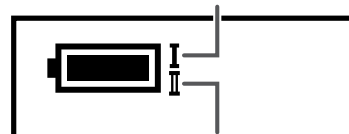

Battery usage indicator for the optional external battery with hand strap BT-LCA1

When both indicators appear, the camcorder consumes power from both battery packs. When one indicator appears, it consumes power from the indicated battery pack.

Basic Operations

Camera Recording

Using Earphones (Commercially Available)

Available modes:

Tape Camera, Tape Playback

You can monitor the sound via stereo earphones (commercially available) during playback or recording. Stereo earphones with a 3.5 mm diameter plug can be used with this camcorder.

Connect the plug of stereo earphones to the earphones jack on the camcorder as shown below.

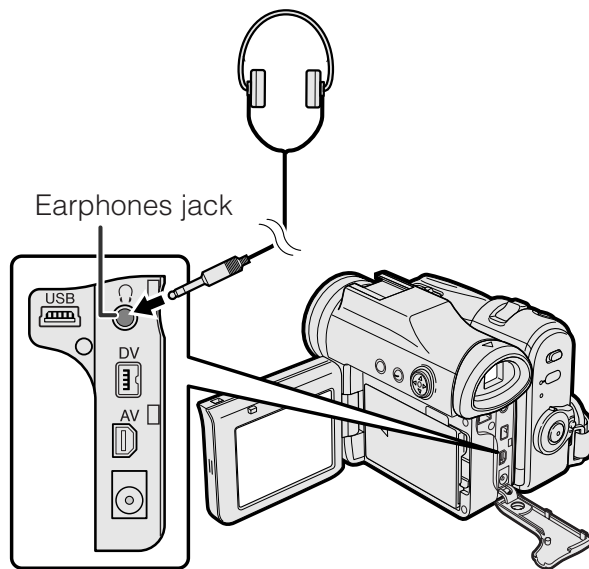

Notes:





- Before connecting stereo earphones, turn the camcorder volume down to the lowest setting.
- The built-in speaker automatically turns off when stereo earphones are connected to the earphones jack.

Adjusting the Phones Volume





Available mode:

Tape Camera

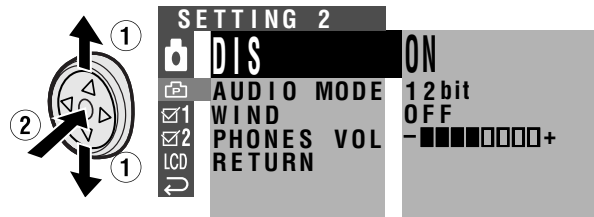
You can adjust the phones volume if sound through the earphones is difficult to hear.

- 1 Set the Media Selection switch to , then hold down the Lock button and set the Power switch to  (see page 22).
- 2 Press the MENU button to display the menu screen.
- 3 Press  or  on the Operation button to select , then press the centre of the Operation button.



- 4 Press  or  to select "PHONES VOL", then press the centre of the Operation button.
- 5 Press  or  to adjust to the desired volume level, then press the centre of the Operation button.



- 6 Press the MENU button to turn off the menu screen.

Note:

- During playback, you can use the Volume control to adjust the earphones (see page 30).

Basic Operations

Playback

Tape Playback

Available mode:
Tape Playback

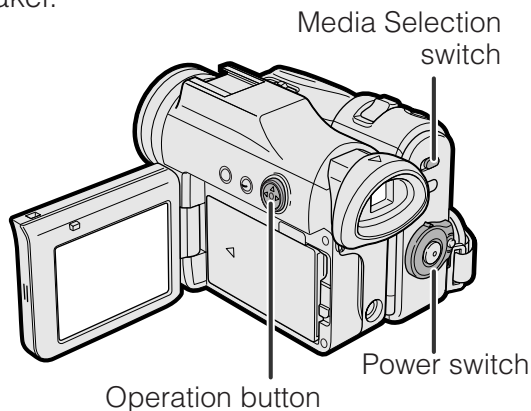

The LCD monitor screen functions as a handy playback monitor. Nothing needs to be connected, allowing instant on-screen playback with the sound through the built-in speaker.



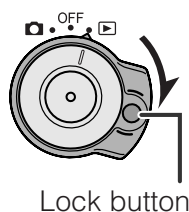
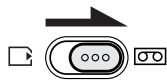

1 Set the Media Selection switch to .

2 Hold down the Lock button and set the Power switch to .

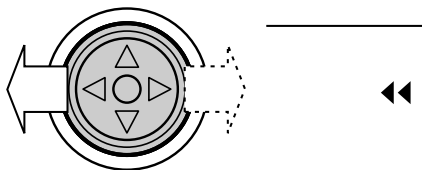

3 Press  (or ) on the Operation button to rewind (or fast forward) the tape to the desired point.



4 Press  to begin playback.

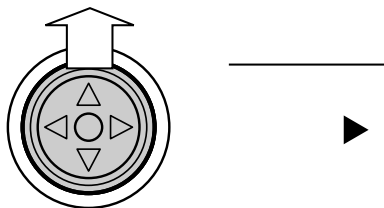

To stop playback

Press .



To turn the power off

Set the Power switch to OFF without pressing the Lock button.

Notes:

- The tape automatically rewinds when playback reaches the end of the tape.
- When selecting "5 MIN" or "10 MIN" in power save mode and remaining in stop mode without any operation for 5 or 10 minutes, the camcorder will turn off automatically.

Watching the playback in the viewfinder

You can also watch the playback in the viewfinder by closing the LCD monitor with the screen facing in. You cannot monitor the sound through the speaker when watching the playback in the viewfinder.

Basic Operations

Playback

Volume Control

Available mode:
Tape Playback

When the camcorder is in Tape Playback mode, push the Volume control to the + or - side to increase (①) or decrease (②) the volume.

The volume level indicator will appear on the LCD screen during adjustment only. Once the Volume control is released, the volume level indicator will disappear shortly afterwards.

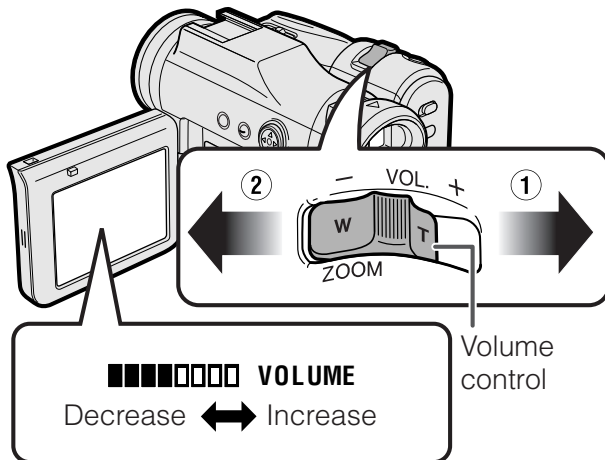

Video Search

Available mode:
Tape Playback

The video search function makes it easy to search for a desired scene on the tape.

Searching for a Scene Near the Current Tape Position

- 1 During Tape Playback, press \triangleright (or \triangleleft) on the Operation button.
 - The playback picture fast forwards (or reverses).

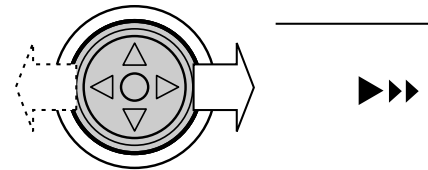

- 2 When you find the scene, press \triangle to return to normal playback.

Searching for a Scene Far from the Current Tape Position

- 1 During fast forward (or rewind) in Tape Playback mode, press and hold \triangleright (or \triangleleft) on the Operation button.
 - The fast forward (or rewind) picture displays.
- 2 If the scene is still rather far from the current tape position, release the Operation button to normal fast forward (or rewind).
- 3 Repeat steps 1 and 2 above until you find the scene.
- 4 Press \triangle to begin normal playback.

Notes:

- The sound is off during search.
- You may experience picture noise during search. This is not a malfunction.

Still

Available mode:
Tape Playback

The still function allows you to pause in Tape Playback mode.

During Tape Playback, press \triangle on the Operation button.

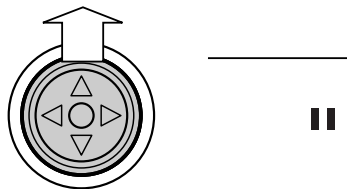

To return to normal playback, press \triangle again.

Notes:

- The sound is off in Still mode.
- To protect the tape, the camcorder automatically returns to normal playback if it is left in Still mode for more than 5 minutes.

Watching Playback on a TV

Available modes:

Tape Playback, Card Playback

You can connect the camcorder to a TV to allow a larger audience to enjoy playback.

- 1 Open the terminal cover on the camcorder (see page 2).

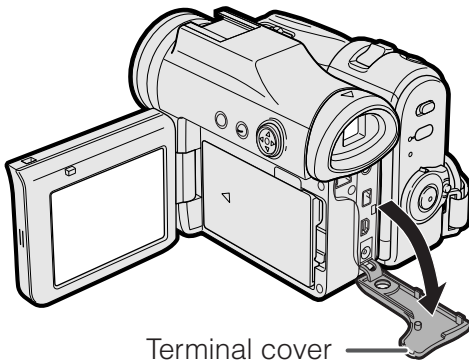

- 2 Connect the camcorder to your TV (or VCR) with the supplied audio/video/S-video cable, as shown.

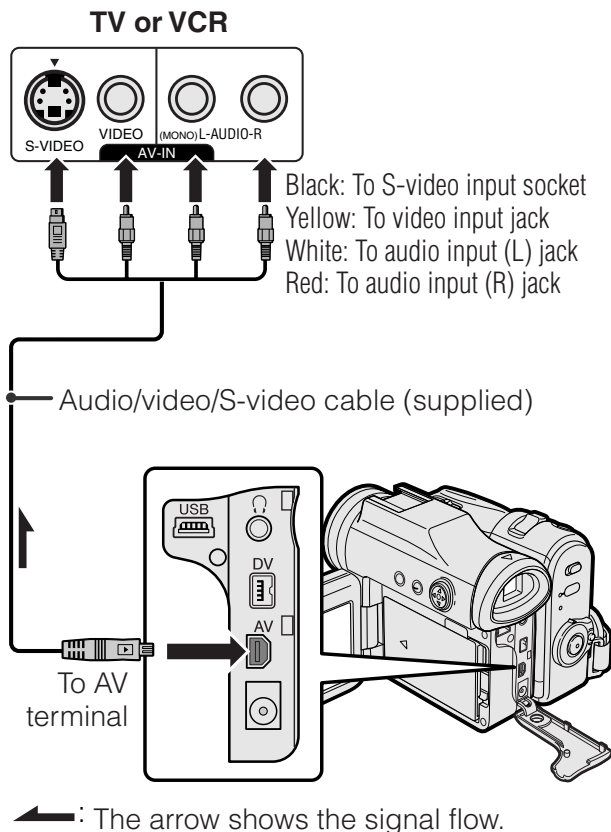

Note:

- Check that the camcorder, TV, VCR and other equipment to be used are turned off before making any connections. Picture noise or malfunction may occur if any of the above is left on while making a connection.

- 3 Turn on the TV and set it to the “AV” or “VIDEO” channel. (See the operation manual of your TV.)
 - When connecting to a TV via a VCR, turn on the VCR and set it to the “AV” or “LINE” input channel. Operate the TV as you normally do to view the signal from the VCR. (See the operation manuals of your TV and VCR.)
- 4 Set the Power switch on the camcorder to and begin playback (see page 29).

Notes:

- If your TV or VCR has a 21-pin Euro-SCART connector, use a commercially available RCA/21-pin Euro-SCART conversion connector.
- If your TV or VCR has only one audio input jack, use the white plug for the audio connection on the TV or VCR.
- If your TV or VCR has an S-video input socket, you do not need to connect the yellow video plug.
- Close the terminal cover after use.

About the S-video socket

S-video sockets are used to separately pass the chroma (colour) and luminance (brightness) components of video signals. They serve to improve the picture quality in both recording and playback.

Useful Features

Control Buttons

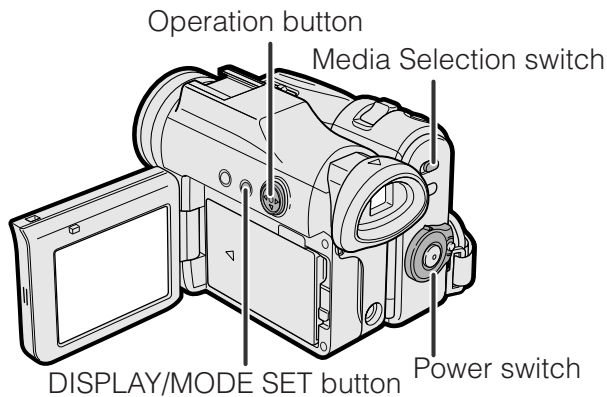

Operation button

Use the Operation button to select and set the desired setting.

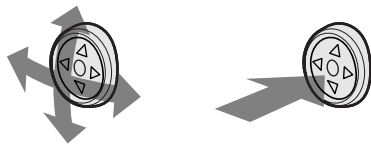

DISPLAY/MODE SET button

Each time you press the DISPLAY/MODE SET button, the screen changes as shown below.

- The example screens shown are for Tape Camera mode.

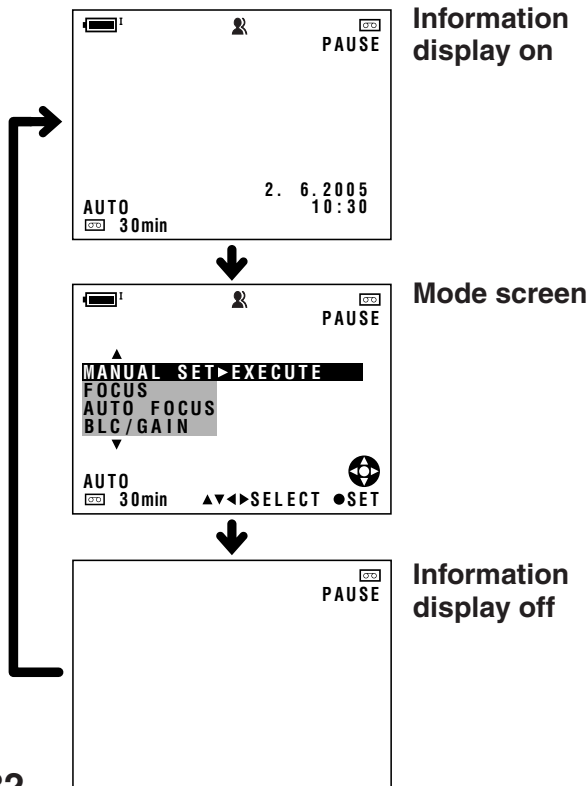

Using the Mode Screens

In the mode screens, you can adjust the camcorder settings by using the Operation button.

- Set to the desired camcorder mode by using the Media Selection switch and the Power switch (see page 22).
 - See pages 108 to 111 for the mode items you can select in each camcorder mode.
 - Steps 2 to 4 show how to change the SCENE MENU setting in Tape Camera mode.
- Press the DISPLAY/MODE SET button until the mode screen appears.

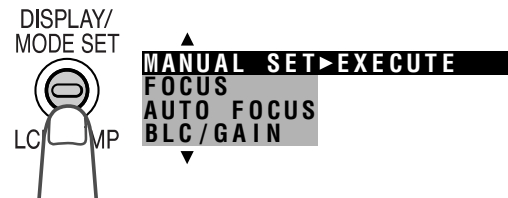

- Press ∇ or Δ on the Operation button to select the desired mode item (SCENE MENU), then press the centre of the Operation button.

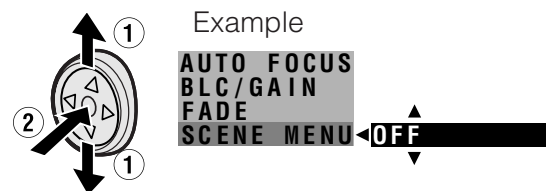

- Press ∇ or Δ to select the desired mode setting (DUSK), then press the centre of the Operation button.

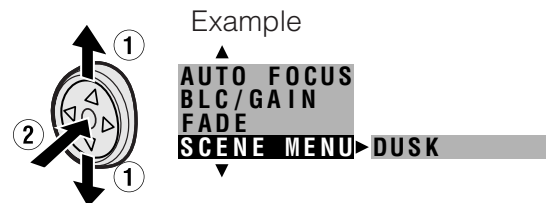

To turn off the mode screen

Press the DISPLAY/MODE SET button.

Note:

- Items that are not selectable are greyed out.

Using the Menu Screens

Use the menu screens to adjust the various camcorder settings.

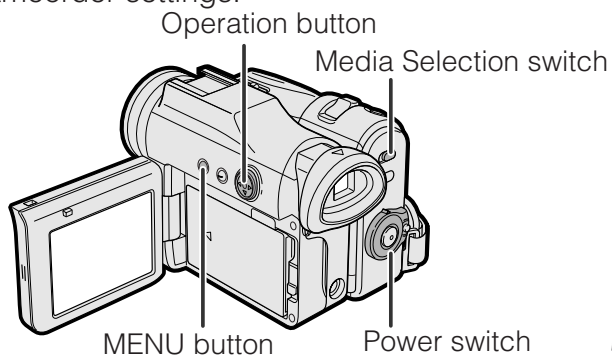

- 1 Set to the desired camcorder mode by using the Media Selection switch and the Power switch (see page 22).
 - See pages 108 to 111 for the menu items you can select in each camcorder mode.
 - Steps 2 to 5 show how to change the DGTL ZOOM menu setting in Tape Camera mode.

- 2 Press the MENU button to display the menu screen.

Example

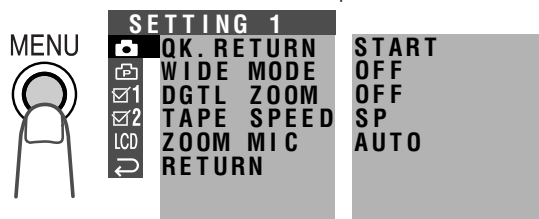

Note:

- The menu screen does not appear during recording.

- 3 Press ∇ or \triangle on the Operation button to select the desired menu screen (📷), then press the centre of the Operation button.

Example

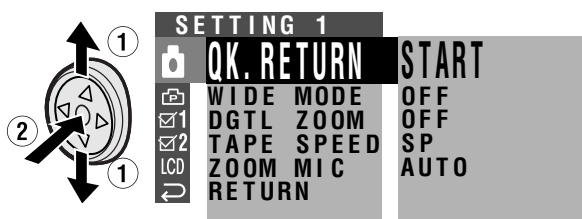

- You can press \triangleright , instead of the centre of Operation button.

- 4 Press ∇ or \triangle to select the desired menu item (DGTL ZOOM), then press the centre of the Operation button.

Example

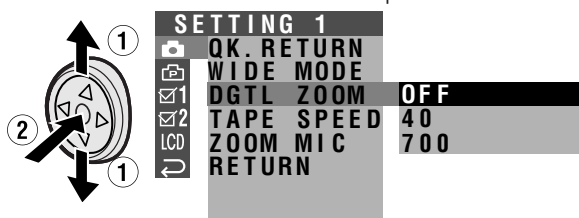

- You can press \triangleright , instead of the centre of the Operation button.

- 5 Press ∇ or \triangle to select the desired menu setting (40), then press the centre of the Operation button.

DGTL ZOOM 40

- You can press \triangleleft , instead of the centre of the Operation button.
- To adjust another menu item, press ∇ or \triangle to select "RETURN" and press the centre of the Operation button, then perform steps 3 to 5.

To turn off the menu screen

Press the MENU button.

Notes:

- Certain menu items are common to all camcorder modes. If the BEEP menu item, for example, is set to "OFF" in Tape Camera mode, it will be automatically set to "OFF" in other modes.
- The menu screen automatically turns off if no settings are made within 5 minutes.
- Items that are not selectable are greyed out.

Useful Features

Camera Recording

Setting the Digital Zoom

Available mode:

Tape Camera

You can select three different zoom ranges: 1–10× (optical zoom), 10–40× (digital zoom) or 10–700× (digital zoom). The digital zoom allows you to record powerful close-up pictures with the same operation as normal zooming.

Notes:

- The digital zoom is in addition to the optical zoom giving a combined maximum zoom range of 1–700×.
- **As the image is enlarged digitally, the picture quality decreases when higher digital zoom settings are used.**

The “D” digital zoom indicator is displayed during digital zooming.

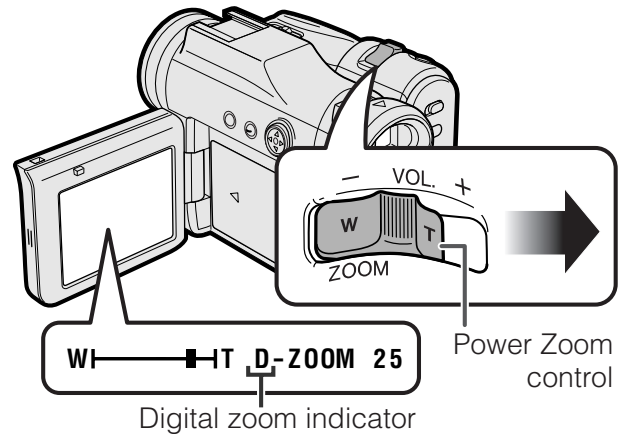

To use optical zoom only

Select “OFF” in step 4 above.

Useful Features

- 1 In Tape Camera mode, press the MENU button to display the menu screen.
- 2 Press ∇ or Δ on the Operation button to select , then press the centre of the Operation button.
- 3 Press ∇ or Δ to select “DGTL ZOOM”, then press the centre of the Operation button.

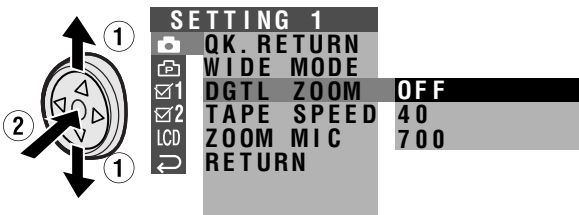

- 4 Press ∇ or Δ to select “40” or “700”, then press the centre of the Operation button.

DGTL ZOOM 40

- 5 Press the MENU button to turn off the menu screen.

Backlight Compensation (BLC)

Available modes:

Tape Camera, Card Camera

When the subject is backlit, the image will appear dark if it is recorded normally. Use the backlight compensation (BLC) function to brighten the entire screen.

- The example screens shown are for Tape Camera mode.

- 1 In Tape Camera or Card Camera mode, press the DISPLAY/MODE SET button until the mode screen appears.

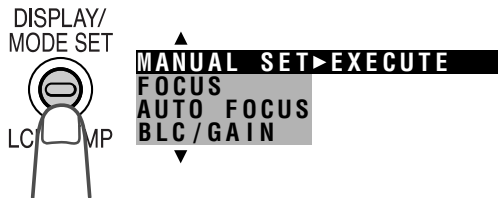

- 2 Press ∇ or \triangle on the Operation button to select "BLC/GAIN", then press the centre of the Operation button.
- 3 Press ∇ or \triangle to select "ON ", then press the centre of the Operation button.



- 4 Press the DISPLAY/MODE SET button to turn off the mode screen.

- " " appears when on-screen indicators are turned on, indicating that the backlight compensation is now working.

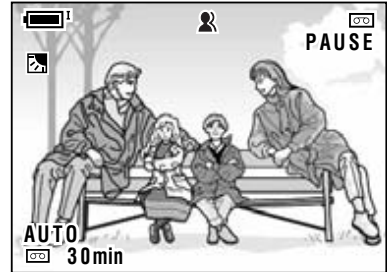

To cancel the backlight compensation function

Select "OFF" in step 3 above.

Useful Features

Camera Recording

Gain-up

Available modes:

Tape Camera, Card Camera

When you are recording in a dark or poorly illuminated location, "LIGHT" is displayed on the screen. Use the gain-up function to record a brighter picture.

Note:

- At locations where lighting is adequate, "LIGHT" will not appear. The gain-up function cannot be used in this case.
- The example screens shown are for Tape Camera mode.

- 1 In Tape Camera or Card Camera mode, press the DISPLAY/MODE SET button until the mode screen appears.

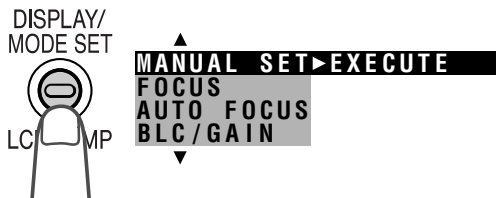

- 2 Press ∇ or \triangle on the Operation button to select "BLC/GAIN", then press the centre of the Operation button.
- 3 Press ∇ or \triangle to select "ON ", then press the centre of the Operation button.



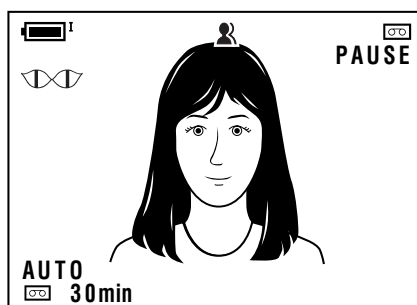

- 4 Press the DISPLAY/MODE SET button to turn off the mode screen.
 - "" appears when on-screen indicators are turned on, indicating that the gain-up function is now working.



To cancel the gain-up function

Select "OFF" in step 3 above.

Notes:

- You may experience some picture noise in Gain-up mode, which increases when the  appears.
- When the  indicator appears, you may get a shadow image behind a subject that is moving around a lot.
- Fine brightness adjustments are possible when using manual iris (see page 61).
- The  indicator will disappear and Gain-up mode will cancel if you aim the camcorder in a bright location.

Fine Picture

Available modes:

Tape Camera, Card Camera

When the subject is backlit, the image will appear dark if it is recorded normally. The fine picture function improves the picture by increasing the brightness of the subject while leaving the brighter portion of the image unaffected. It is useful if using the BLC function causes undesired effects because of a great difference between the brightness of the subject and background.

- The example screens shown are for Tape Camera mode.

- In Tape Camera or Card Camera mode, press the DISPLAY/MODE SET button until the mode screen appears.

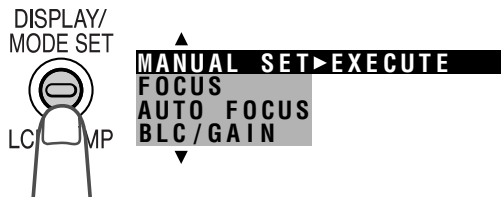

- Press ∇ or \triangle on the Operation button to select "FINE PIC.", then press the centre of the Operation button.

- Press ∇ or \triangle to select the desired fine picture setting then press the centre of the Operation button.

FINE PIC. ▶ LEVEL 1

- Each time you press ∇ or \triangle , the setting changes as shown below. "LEVEL 1" is the least bright, and "LEVEL 3" is the brightest.

Fine picture setting	On-screen indicator
LEVEL 3	
↕	
LEVEL 2	
↕	
LEVEL 1	
↕	
OFF	None

- Press the DISPLAY/MODE SET button to turn off the mode screen.

- "", "", or "" appears when on-screen indicators are turned on, indicating that the fine picture function is now working.

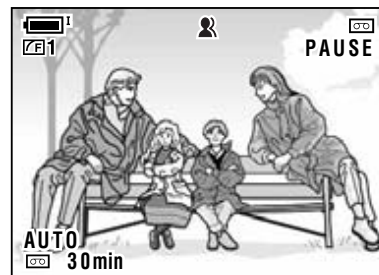

To cancel the fine picture function

Select "OFF" in step 3 above.

Useful Features

Camera Recording

Using the Built-in LED Video Light

Available modes:

Tape Camera, Card Camera

You can use the built-in LED video light to brighten the scene when natural lighting is too dim.



Built-in LED video light

Types

OFF: Turn off the LED video light.

AUTO: Turn on/off the LED video light automatically depending on light condition.

ON: Turn on the LED video light.

- The example screens shown are for Tape Camera mode.

- 1 In Tape Camera or Card Camera mode, press the DISPLAY/MODE SET button until the mode screen appears.

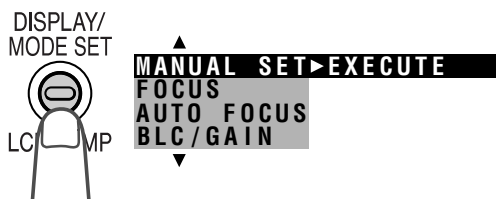

- 2 Press ∇ or \triangle on the Operation button to select "LED LIGHT", then press the centre of the Operation button.

- 3 Press ∇ or \triangle to select the desired LED light setting, then press the centre of the Operation button.

LED LIGHT ▶ ON

- 4 Press the DISPLAY/MODE SET button to turn off the mode screen.

- "🔊" appears when on-screen indicators are turned on, indicating that the LED video light function is now working.

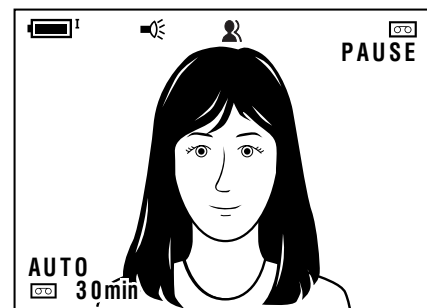

- 5 Adjust the field angle in the range of 1 m to 1.5 m, then begin recording.

To cancel the LED video light function

Select "OFF" in step 3 above.

Notes:

- Use the LED video light in the range of 1 m to 1.5 m.
- Do not look straight at the light as it may damage your vision.
- Using the LED video light will increase power consumption. Turn off the video light when you do not use it.
- When the shutter speed is set to "AUTO", and the LED video light is set to "AUTO" or "ON", the picture may be rough or shadow images may occur on a moving subject. To prevent shadow images, set the shutter speed manually to 1/50 sec. (see page 63).
- The light range is limited. Check the screen while recording.

Fade In and Fade Out

Available mode:

Tape Camera

The fade function allows you to gradually bring the image and sound in or out at the beginning or end of a scene for creating scene transitions. This is especially effective in creating a dramatic change in scenery.

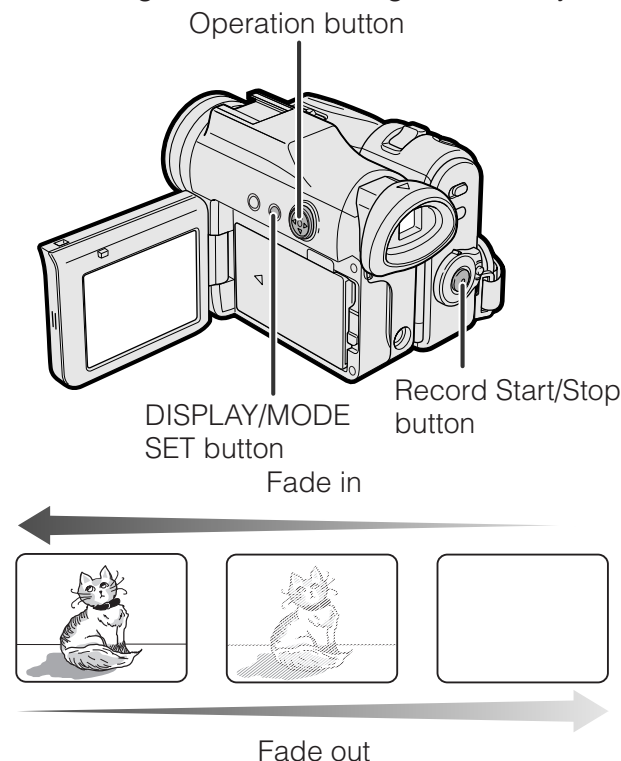

Using

- 1 In Tape Camera mode, press the DISPLAY/MODE SET button until the mode screen appears.
- 2 Press ∇ or \triangle on the Operation button to select "FADE", then press the centre of the Operation button.

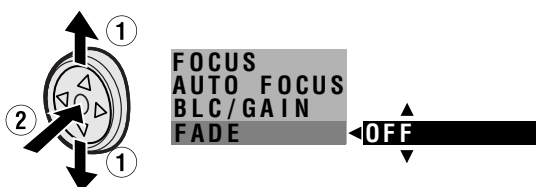

- 3 Press ∇ or \triangle to select "ON", then press the centre of the Operation button.

- 4 Press the DISPLAY/MODE SET button until on-screen indicators appear.
- 5 Press the Record Start/Stop button to begin recording.
 - The picture turns white, and the image and sound fade in.

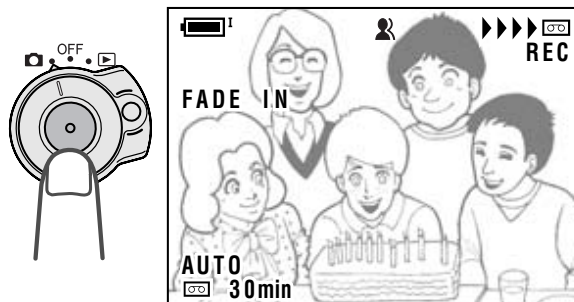

- 6 Press the Record Start/Stop button at the point where you wish to stop recording.
 - The image and sound fade out as the picture gradually turns white. The camcorder then returns to Recording Standby mode.

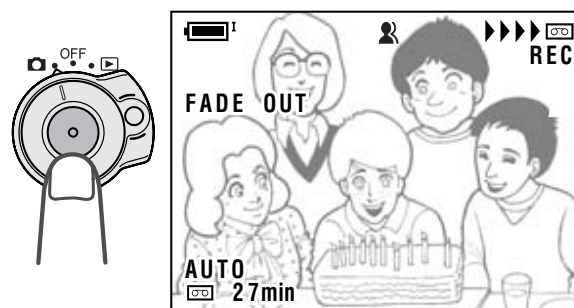

To cancel Fade mode

Select "OFF" in step 3 above.

To use Fade Out only

- 1 During camera recording in Tape Camera mode, press the DISPLAY/MODE SET button until the mode screen appears.
- 2 Perform steps 2 and 3 in "Using".
- 3 Press the Record Start/Stop button at the point where you wish to stop recording.

Note:

- Fade mode automatically cancels after Fade Out.

Useful Features

Camera Recording

Quick Return

Available mode:

Tape Camera

If while playing back your tape you want to quickly return to the last recorded scene and start recording again, use the quick return function.

- 1 Set the camcorder to Tape Camera mode.
- 2 In Recording Standby mode, press the MENU button to display the menu screen.
- 3 Press ∇ or \triangle on the Operation button to select , then press the centre of the Operation button.
- 4 Press ∇ or \triangle to select "QK. RETURN", then press the centre of the Operation button.

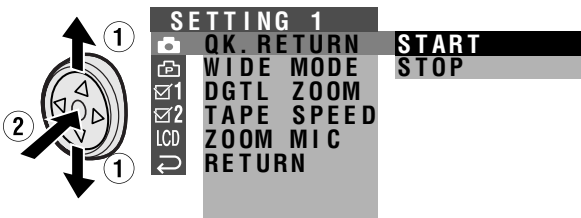

- 5 Press ∇ or \triangle to select "START", then press the centre of the Operation button.

- "SEARCH" flashes, and the tape begins fast forwarding or rewinding to the end of the last recorded scene.



- When the tape reaches the end of the last recorded scene, "FINISHED" is displayed, and the camcorder enters Recording Standby mode.
- 6 Press the MENU button to turn off the menu screen.

Notes:

- To cancel the quick return function while "SEARCH" is flashing, press the centre of Operation button twice.
- Quick return will not work if you remove the cassette and reload it after recording or if nothing has been recorded since loading.
- When the camcorder remains in Recording Standby mode for more than 5 minutes and enters stop mode, quick return will not work.

Edit Search

Available mode:

Tape Camera

The edit search function lets you search, without switching from Tape Camera mode to Tape Playback mode, for the point on the tape where you wish to start recording next.

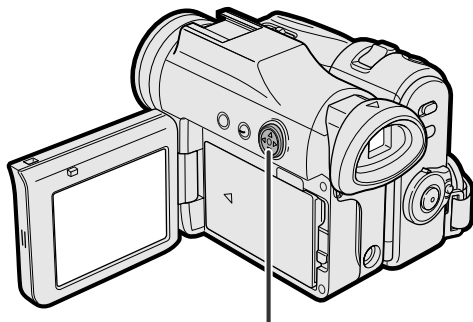

Operation button

- 1 Set the camcorder to Tape Camera mode.
- 2 In Recording Standby mode, press and hold down ◀ (reverse edit search) or ▶ (forward edit search) on the Operation button.
- 3 When you find the point where you want to begin recording, release the button.

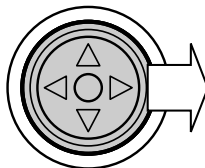
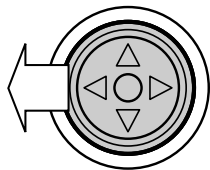

Notes:

- The sound is off during search.
- Forward edit search is performed at the same speed as normal playback, and reverse edit search at 6.5 times the normal playback.
- You may experience picture noise during reverse edit search.
- When the camcorder remains in Recording Standby mode for more than 5 minutes and enters stop mode, edit search will not work.

Still Recording on Tape

Available mode:

Tape Camera

You can record continuous still images of subjects.

- 1 Set the camcorder to Tape Camera mode.
- 2 In Recording Standby mode, press the PHOTO button fully.
 - A still image of the subject is displayed.

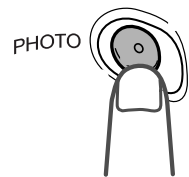

- 3 Press the Record Start/Stop button.
 - The still image of the subject will be recorded.
 - During still recording, "RECORDED ON TAPE" appears on the screen.

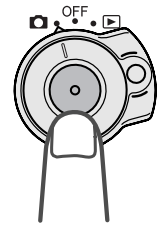

To pause recording

Press the Record Start/Stop button.

To cancel the still image

Press the PHOTO button fully.

Notes:

- Still Recording can also be used during recording by pressing the PHOTO button fully.
- The picture quality in Still Recording function will be slightly lower than normal pictures.

Useful Features

Camera Recording

Digital Image Stabilization (DIS)

Available mode:
Tape Camera

The digital image stabilization (DIS) function allows you to stabilize the image by electronically compensating for relatively minor image shaking that is often annoying in close-up shots.

- 1 In Tape Camera mode, press the MENU button to display the menu screen.
- 2 Press ∇ or Δ on the Operation button to select \square , then press the centre of the Operation button.
- 3 Press ∇ or Δ to select "DIS", then press the centre of the Operation button.

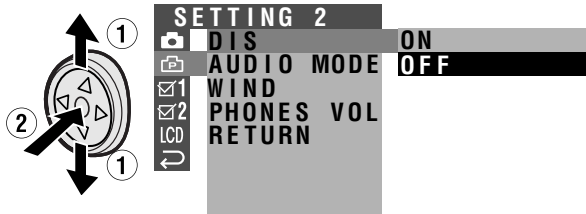

- 4 Press ∇ or Δ to select "ON", then press the centre of the Operation button.

DIS ON

- 5 Press the MENU button to turn off the menu screen.
 - The DIS indicator only appears when the on-screen indicators are turned on.

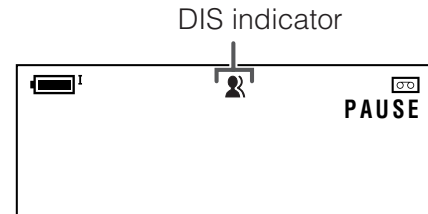

To cancel DIS function

Select "OFF" in step 4 above. The  indicator will disappear.

Notes:

- The DIS function cannot compensate for excessive image shaking.
- When image shaking does not occur (e.g. when using the camcorder on a tripod), turn off the DIS function. The picture will appear more natural when the DIS function is off.

Wide Mode

Available mode:

Tape Camera

Wide mode lets you record scenes with squeezed images so that you can enjoy high-density wide images when you playback the images via widescreen TV.

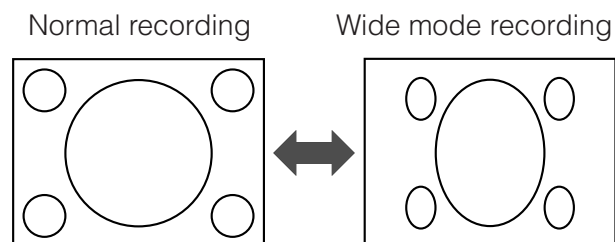

- 1 In Tape Camera mode, press the MENU button to display the menu screen.
- 2 Press ∇ or Δ on the Operation button to select , then press the centre of the Operation button.
- 3 Press ∇ or Δ to select "WIDE MODE", then press the centre of the Operation button.

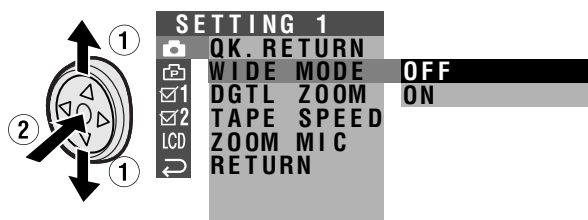

- 4 Press ∇ or Δ to select "ON", then press the centre of the Operation button.

WIDE MODE ON

- 5 Press the MENU button to turn off the menu screen.

To cancel the wide mode

Select "OFF" in step 4 above.



Power Save Mode

Available modes:

All modes

Power save mode will turn off the camcorder automatically to save battery power when the camcorder is not in use for 5 or 10 minutes.

Note:

- To resume recording or playback, set the Power switch to OFF, then back to  or .
- The example screens shown are for Tape Camera mode.

- 1 Turn on the camcorder, then press the MENU button to display the menu screen.
- 2 Press ∇ or Δ on the Operation button to select , then press the centre of the Operation button.
- 3 Press ∇ or Δ to select "POWER SAVE", then press the centre of the Operation button.

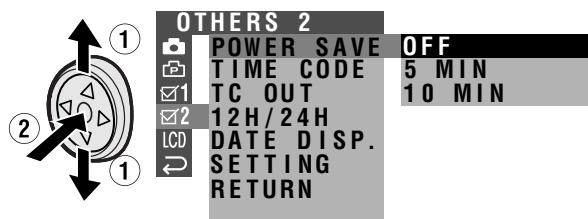

- 4 Press ∇ or Δ to select "5 MIN" or "10 MIN", then press the centre of the Operation button.

POWER SAVE 5 MIN

- 5 Press the MENU button to turn off the menu screen.

To cancel the power save mode

Select "OFF" in step 4 above.

Notes:

- The camcorder will not turn off when recording, playing back, AV or DV inputting or connecting the USB cable.
- The camcorder will turn off prior to Power Standby mode.

Useful Features

Camera Recording

Self Recording

Normal self recording

Available modes:

Tape Camera, Card Camera

Open the LCD monitor and rotate it 180° vertically so that the screen faces the other way and the subject can monitor the shot while you are recording with the viewfinder.

If the camcorder is steadied, you can record yourself in the scene by watching yourself on the LCD monitor. The remote control is useful for such occasions.



Useful Features

- 1 Pull out the viewfinder completely. Open the LCD monitor to a 90° angle to the camcorder body (1), and then rotate it 180° vertically (2).

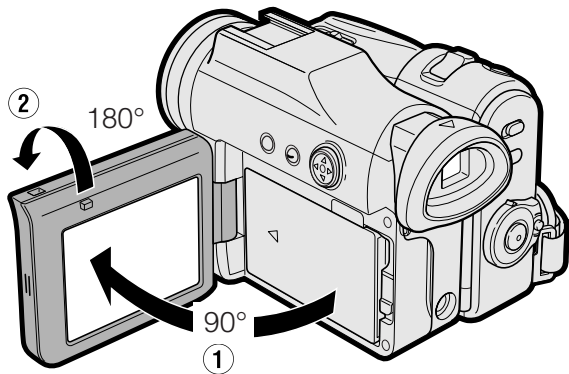

- 2 Set the Media Selection switch to  or .

- 3 Set the Power switch to .
 - The subject is displayed in the viewfinder, and a mirror image of the subject is displayed on the LCD monitor.

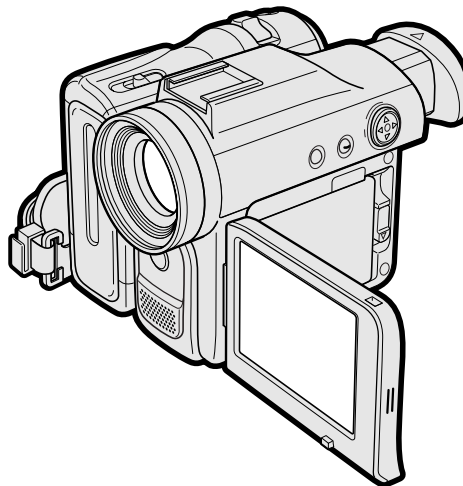

- 4 Begin recording.

Notes:

- Use the remote control to begin/stop recording on tape.
- You can play back images while the monitor is in the self recording position. Set the camcorder to Tape Playback or Card Playback mode.

Self recording with reversed grip

Available mode:

Tape Camera

Rotate the grip 105° and the LCD monitor 180° vertically so that you can record yourself while holding the grip.

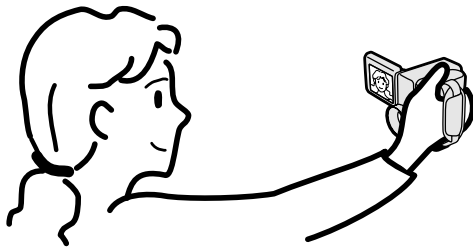

- 1 Turn the camcorder downward as shown below.



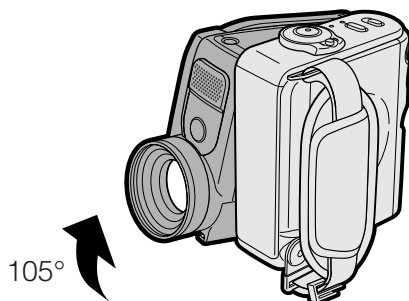

- 2 Rotate the lens section 105° vertically as shown below.



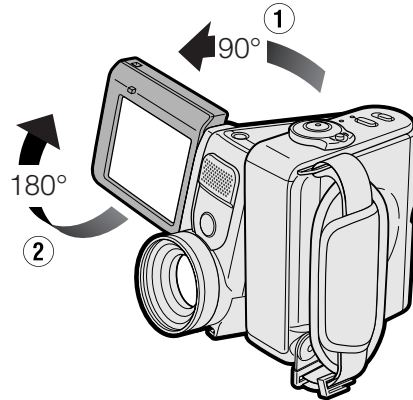

- 3 Open the LCD monitor to a 90° angle to the camcorder body (1), and then rotate it 180° vertically (2).



- 4 Set the Media Selection switch to .
- 5 Set the Power switch to .
- 6 Begin recording.

Notes:

- Do not rotate the monitor section to the self recording position during recording or playback.
- During self recording with reversed grip, the mode or menu screen cannot be displayed.
- All of the manual settings are set to AUTO and some other settings will set to OFF in self recording with reversed grip.
- You may experience image noise when using self recording.
- To operate self recording with reversed grip correctly, make sure to turn the grip and the lens section so that the Record Start/Stop button and the tripod socket face upward, and the lens faces toward you. The  indicator will appear.
- Be sure that the LCD monitor rotation is exactly 180°, otherwise the image recorded will be rotated 180° upside-down.
- In self recording with reversed grip in Card Camera mode, the still images will be recorded rotated 180° upside down. The  indicator will appear in this case.
- The viewfinder does not work in self recording with reversed grip.
- It is recommended to set the LED video light to "OFF" in self recording.

Useful Features

Camera Recording

Recording in LP (Long Play Recording) Mode

Available mode:
Tape Camera

This camcorder allows you to record in LP (Long Play Recording) mode for approximately 50% more recording time with the same picture quality as that in SP (Standard Play Recording) mode.

- 1 In Tape Camera mode, press the MENU button to display the menu screen.
- 2 Press ∇ or Δ on the Operation button to select , then press the centre of the Operation button.
- 3 Press ∇ or Δ to select "TAPE SPEED", then press the centre of the Operation button.

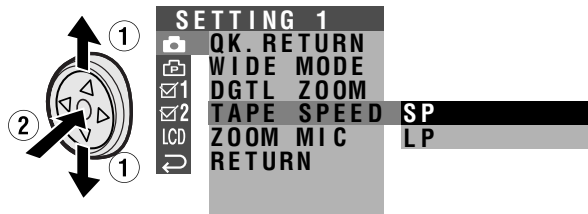

- 4 Press ∇ or Δ to select "LP", then press the centre of the Operation button.

TAPE SPEED LP

- 5 Press the MENU button to turn off the menu screen.
 - The long play recording mode indicator only appears when the on-screen indicators are turned on.



Long play recording mode indicator

To return to SP mode

Select "SP" in step 4 above.

Notes on the use of LP mode

- To record in LP mode, be sure to use a Mini DV cassette labelled for use with LP mode.
- Frozen images, mosaic-pattern picture noise, audio interruptions or audio loss may occur in the following cases:
 - When using a tape which is not designated for use with LP mode.
 - When a tape recorded in LP mode under high temperature conditions is played back.
 - When a tape recorded in LP mode with the camcorder is played back on a Mini DV player or camcorder from another manufacturer.
 - When a tape recorded in LP mode is played back on a Mini DV player or camcorder without an LP function.
- Audio dubbing is not possible with LP mode recording.

Selecting the 16-bit Audio Recording Mode

Available mode:

Tape Camera

The camcorder normally records audio in the 12-bit audio recording mode. For higher-quality audio recording, select the 16-bit audio recording mode.

- 1 In Tape Camera mode, press the MENU button to display the menu screen.
- 2 Press ∇ or \triangle on the Operation button to select \square , then press the centre of the Operation button.
- 3 Press ∇ or \triangle to select "AUDIO MODE", then press the centre of the Operation button.

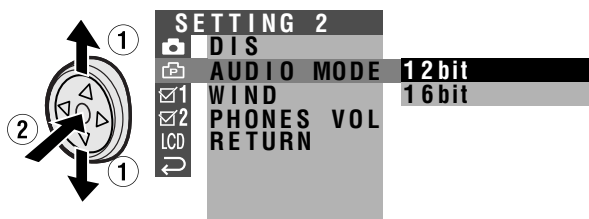

- 4 Press ∇ or \triangle to select "16bit", then press the centre of the Operation button.

AUDIO MODE 16 bit

- 5 Press the MENU button to turn off the menu screen.
 - The 16-bit audio recording mode indicator only appears when the on-screen indicators are turned on.



16-bit audio recording mode indicator

To return to 12-bit audio recording mode

Select "12bit" in step 4 above.

Note:

- When using Audio Dubbing with 16-bit audio recordings, both the dubbed and original sounds will be recorded in mono (see page 68).

Useful Features

Camera Recording

Using the Zoom Microphone (Optional Accessory)

Available mode:

Tape Camera

With the optional zoom microphone VR-8MC, you can record audio according to the magnification of the zoom lens for producing the optimum sound.

Mounting

- 1 Align the zoom microphone with the zoom microphone shoe on the camcorder, and slide it in the direction of the arrow until it locks into place.

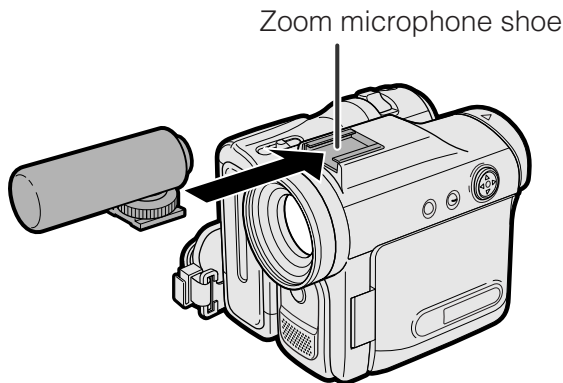

- 2 Turn the screw in the direction of the arrow to secure the microphone.

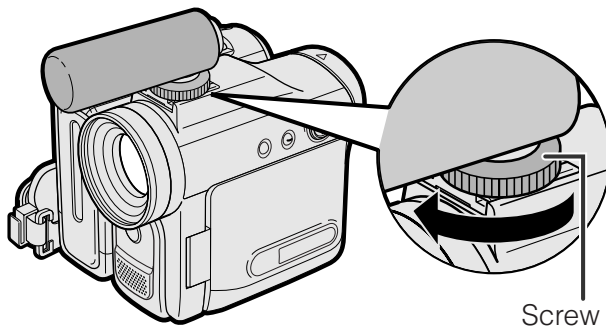

Removing

Turn the screw in the opposite direction than when mounting, then pull off the zoom microphone.

Notes:

- Do not pick up the camcorder by the zoom microphone, as this may damage the equipment.
- The zoom microphone shoe on the camcorder is designed only for use with the specified equipment.

Selecting the Zoom Microphone Mode

Select a zoom microphone mode when the zoom microphone is mounted.

Types

AUTO: The camcorder automatically selects the optimum sound according to the magnification of the zoom lens. When the zoom lens is at a wide-angle setting, the built-in microphone is used to record sounds. As the zoom magnification increases, the sounds from the zoom microphone and built-in microphone are mixed according to the zoom setting.

TELE: The zoom microphone is fixed to record sounds at a distance. (The built-in microphone is turned off.)

OFF: The zoom microphone is turned off. (The built-in microphone is on.)

Note:

- The zoom microphone is a monaural type, not a stereo type, so it is useful for speech recording, not music and live concert.

- 1 Mount the optional zoom microphone to the camcorder.
- 2 In Tape Camera mode, press the MENU button to display the menu screen.
- 3 Press ∇ or \triangle on the Operation button to select , then press the centre of the Operation button.
- 4 Press ∇ or \triangle to select "ZOOM MIC", then press the centre of the Operation button.

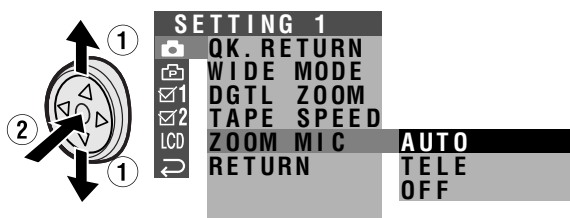

- 5 Press ∇ or \triangle to select the desired zoom microphone mode, then press the centre of the Operation button.

ZOOM MIC TELE

- 6 Press the MENU button to turn off the menu screen.

When the zoom microphone is active, the zoom microphone indicator appears and the zoom range indicator changes as shown below.

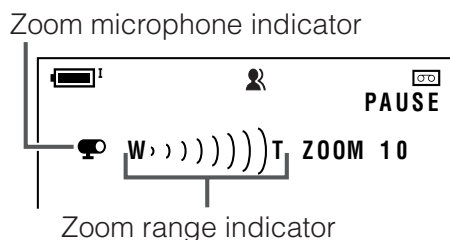

Windbreak

Available mode:

Tape Camera

The windbreak function allows you to reduce annoying noise from strong winds when recording.

- 1 In Tape Camera mode, press the MENU button to display the menu screen.
- 2 Press ∇ or \triangle on the Operation button to select , then press the centre of the Operation button.
- 3 Press ∇ or \triangle to select "WIND", then press the centre of the Operation button.

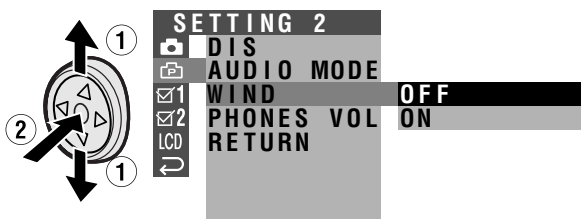

- 4 Press ∇ or \triangle to select "ON", then press the centre of the Operation button.

WIND ON

- 5 Press the MENU button to turn off the menu screen.

To cancel Windbreak

Select "OFF" in step 4 above.

Note:

- Keep the windbreak function off during normal recording. If left on, the recorded audio may sound somewhat muffled when played back.

Useful Features

Playback

Using the Remote Control

Available modes:
All modes

Use the remote control to operate the camcorder from a distance, such as when you want to record yourself in a scene, or when the camcorder is connected to a TV for use as a VCR.

Activating

- The example screens shown are for Tape Playback mode.

- Press the MENU button to display the menu screen.
- Press ∇ or \triangle on the Operation button to select \checkmark 1, then press the centre of the Operation button.
- Press ∇ or \triangle to select "REMOTE", then press the centre of the Operation button.

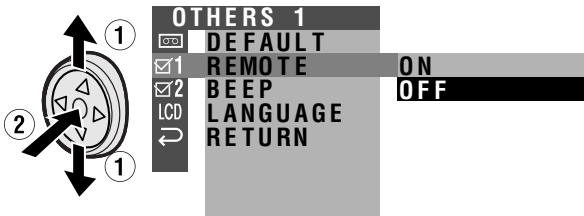

- Press ∇ or \triangle to select "ON", then press the centre of the Operation button.

REMOTE ON

- Press the MENU button to turn off the menu screen.

Operating

Aim the remote control at the remote sensor of the camcorder, and press the control buttons to operate.

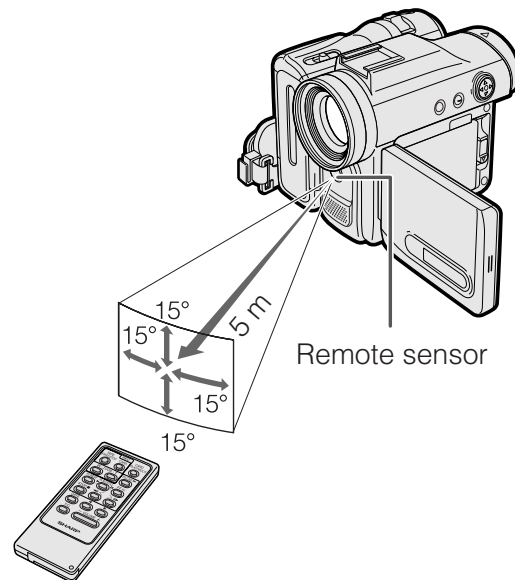

ZOOM (W/T) buttons

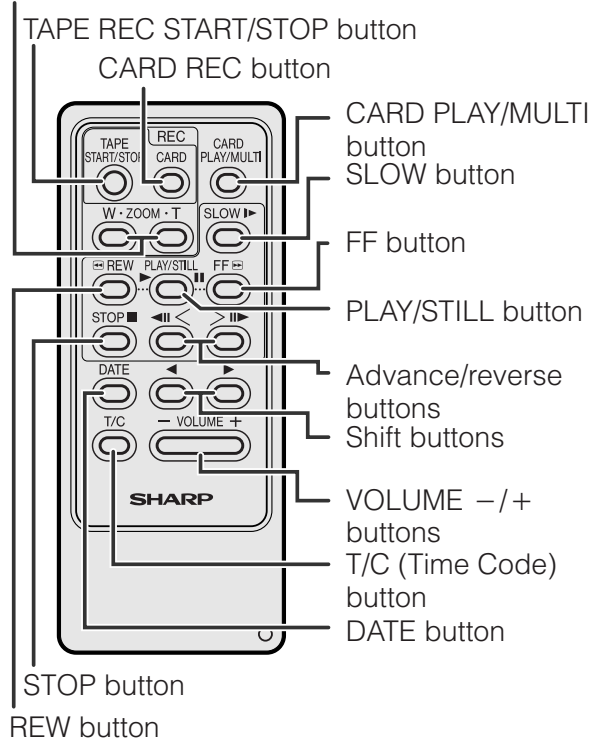

Notes:

- Be careful not to expose the remote sensor to direct sunlight or strong interior lighting, as this may prevent the remote control from operating properly.
- Be sure that there are no obstacles between the remote control and the remote sensor.

Tape Playback Functions with the Remote Control

Available mode:

Tape Playback

You can use the following playback functions with the supplied remote control. (See page 50 for use of the remote control.)

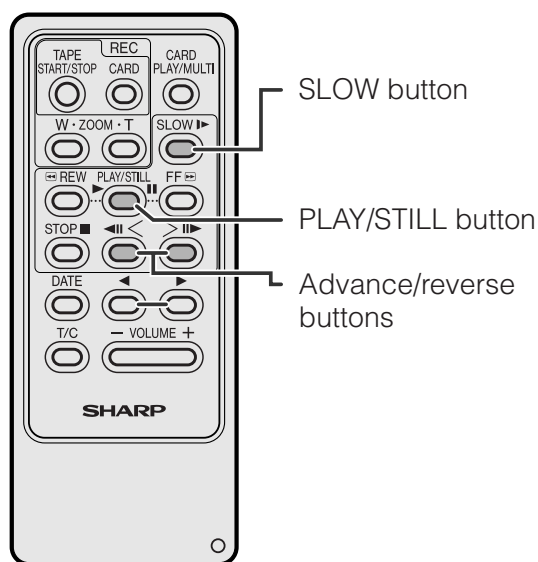

Reverse Playback

The reverse playback function allows you to play back images in reverse.

During Tape Playback, press the ◀|| button.

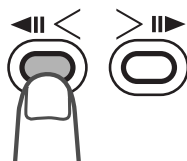

To return to normal playback, press the PLAY/STILL button (▶▶).

Note:

- The camcorder automatically returns to normal playback if it is left in reverse playback for more than 30 minutes.

Slow

The slow function allows you to play back images in slow motion.

During Tape Playback, press the SLOW button (▶▶). Then, select the tape direction using the advance/reverse buttons (◀|| or ▶▶).



To return to normal playback, press the PLAY/STILL button (▶▶) twice.

Note:

- To protect the tape, the camcorder automatically returns to normal playback if it is left in Slow mode for more than 10 minutes.

Frame Advance

The frame advance function allows you to play back still images frame by frame.

1 During Tape Playback, press the PLAY/STILL button (▶▶) to pause playback.



2 Press the ▶▶ (or ◀◀) button.

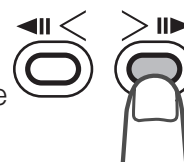

- Each time you press the button, the picture advances one frame forward (or backward).

To return to normal playback, press the PLAY/STILL button (▶▶).

Notes:

- The sound is off during reverse, slow, and frame advance playback.
- If you use the slow or frame advance function with the tape recorded in LP mode, the picture may advance several frames at a time.
- The frame advance moves about 45 frames.

Useful Features

Playback

Selecting the Date and Time of Recording Display

Available modes:

All modes

Follow the procedure below to select the date, or both the date and time, of recording display on the screen. You can display the date and time during both recording and playback.

- The example screens shown are for Tape Playback mode.

- 1 Press the MENU button to display the menu screen.
- 2 Press ∇ or \triangle on the Operation button to select \square 2, then press the centre of the Operation button.
- 3 Press ∇ or \triangle to select "DATE DISP.", then press the centre of the Operation button.

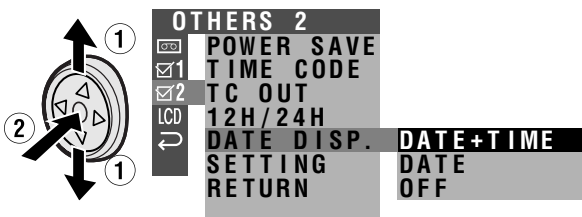

- 4 Press ∇ or \triangle to select the desired setting, then press the centre of the Operation button.

DATE DISP. DATE

- 5 Press the MENU button until the date (or date and time) appears.



Notes:

- **The date (or date and time) appears when the on-screen indicators are turned on.**
- Before recording, make sure that the date and time have been correctly set. If they have not been set, the display will be left blank when playing back the recording. (The display will also be left blank for unrecorded or damaged portions of the tape.)
- In Tape Playback mode, the current date and time are displayed when the tape is not being played back.
- You can also press the DATE button on the remote control to display the date (or date and time).

Picture Effect Playback

Available modes:

Tape Playback, Card Playback

These picture effects let you play back images with a more dramatic effect.

Types

B/W: The picture is displayed in black-and-white.

SEPIA: The picture is displayed in sepia colour similar to that of an old photograph.

SOLARI: The contrast of the subject is enhanced, creating an unique artistic image.

NEGA: The blacks and whites of the image are reversed and colours of the image are inverted.

- The example screens shown are for Tape Playback mode.

- 1** During Tape Playback (or Card Playback), press the DISPLAY/MODE SET button until the mode screen appears.
- 2** Press ∇ or \triangle on the Operation button to select "PIC. EFFECT", then press the centre of the Operation button.

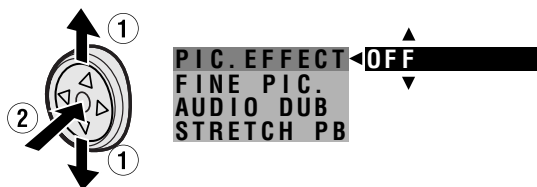

- 3** Press ∇ or \triangle to select the desired picture effect, then press the centre of the Operation button.

PIC. EFFECT \blacktriangleright **B/W**

- 4** Press the DISPLAY/MODE SET button to turn off the mode screen.

To cancel picture effect playback

Select "OFF" in step 3 above.

Notes:

- Video images in picture effect playback mode cannot be transferred via DV cable to a personal computer.
- You cannot use picture effect playback with slide show playback.

Useful Features

Playback

Rotate Playback

Available mode:

Tape Playback

This function allows you to play back images rotated 180°.

- 1 In Tape Playback mode, press the MENU button to display the menu screen.
 - Rotate playback indicator appears.
- 2 Press ▾ or ▲ on the Operation button to select , then press the centre of the Operation button.
- 3 Press ▾ or ▲ to select "ROTATE PB", then press the centre of the Operation button.
 - Rotate playback indicator appears.

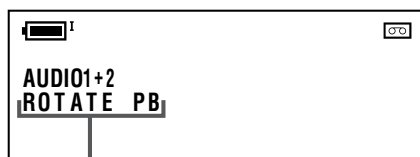
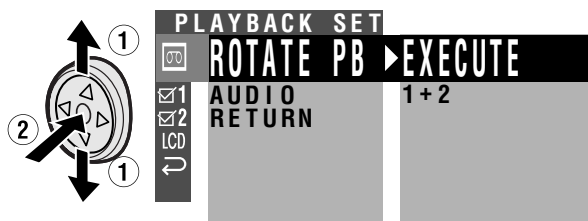

Rotate playback indicator

- 4 Press ▲ to begin rotate playback.
 - The image is rotated 180° upside down.

To cancel rotate playback

Press the centre of the Operation button in step 4 above.

Notes:

- When executing rotate playback during Tape Playback, playback will stop. Press ▲ to begin rotate playback.
- Even if the camcorder is in rotate playback mode, the image output via a DV connection will display as normal playback.
- When you want to display the menu screen during rotate playback, press the centre of the Operation button.
- In rotate playback mode, you cannot perform frame advance, slow, and picture effect playback or copy an image from tape to card.

Fine Picture Playback

Available mode:

Tape Playback

Fine picture playback improves the image in Tape Playback mode by increasing the brightness of the subject while leaving the brighter portions of the image unaffected.

- 1 In Tape Playback mode, press the DISPLAY/MODE SET button until the mode screen appears.

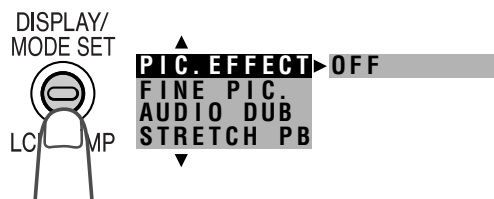

- 2 Press ▾ or ▲ on the Operation button to select "FINE PIC.", then press the centre of the Operation button.

- Press ∇ or \triangle to select the desired fine picture setting then press the centre of the Operation button.

FINE PIC. ▶ LEVEL 1

- Press the DISPLAY/MODE SET button to turn off the mode screen.
 - “**F1**”, “**F2**” or “**F3**” appears when on-screen indicators are turned on, indicating that the fine picture function is now working.



To cancel the fine picture playback

Select “OFF” in step 3 above.

Notes:

- Fine picture playback will set to “OFF” automatically after turning off the camcorder.
- Fine picture setting for recording and fine picture playback setting are separate settings.
- Fine picture playback may have no effect during still playback.

Copying an Image from Tape to Card

Available mode:
Tape Playback

You can capture your favourite image frame from a video tape recording and save it on card.

- Insert the recorded Mini DV cassette and a card in the camcorder.
- Set the camcorder to Tape Playback mode, then begin tape playback.
- Press \triangle on the Operation button at the point where the desired image appears.
 - A still picture of the image appears.

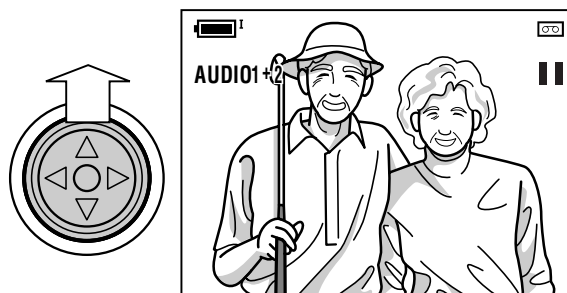

Note:

- To cancel the still picture, press \triangle again.

- Press the PHOTO button to copy the image to the card.
 - The \square indicator flashes red while the image is copied.

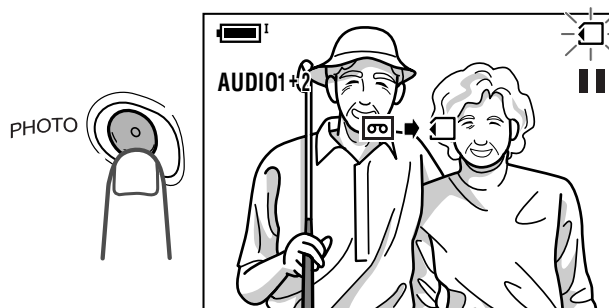

Useful Features

Playback

Stretch Playback

Available mode:

Tape Playback

Stretch playback allows you to playback a squeezed image with the wide screen feel of a movie shown in a theatre. Useful when you want to play back images recorded in wide mode on a 4:3 TV.

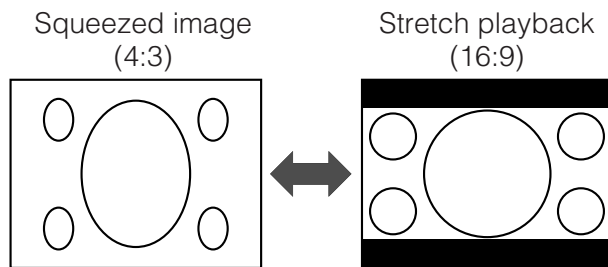

To cancel stretch playback

Press the centre of the Operation button in step 3 above.

Notes:

- “Squeeze” is an image compression technology. A 16:9 image is compressed and recorded (squeeze recorded) as a 4:3 image.
- In stretch playback mode, you cannot perform frame advance, slow, and picture effect playback or copy an image from tape to card.
- When outputting the stretch playback image from the DV terminal, the original image signal will be output.
- When performing stretch playback, the normal recorded image (picture aspect ratio 4:3) will be stretched as shown below.

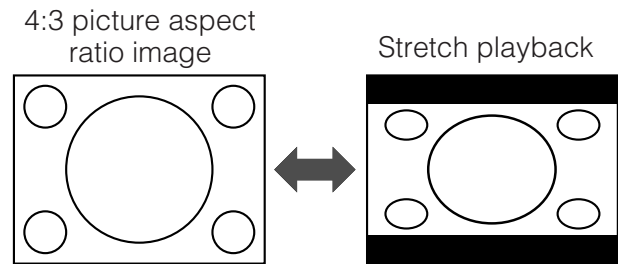

Useful Features

- 1 In Tape Playback mode, press the DISPLAY/MODE SET button until the mode screen appears.
- 2 Press ∇ or Δ on the Operation button to select “STRETCH PB”, then press the centre of the Operation button.



- Playback will stop after turning on stretch playback.

- 3 Press Δ to begin stretch playback.



- The picture displays with black bands.

Advanced Features







Camera Recording

Manual Focus

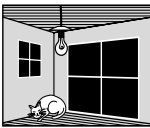
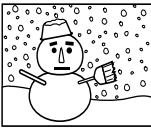
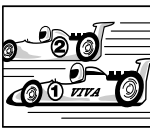
Available modes:

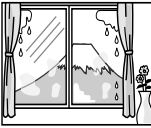
Tape Camera, Card Camera

Auto Focus may not be able to focus on the subject in the situations shown below. In such situations, set the camcorder to Manual Focus mode and focus manually.

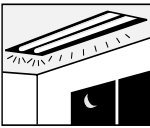
 Subject is too dark.	 Lack of contrast, e.g. snow scene.
 Fast-moving subject.	 Background is too bright.
 Subject has horizontal stripes.	 Subject is being shot through a dirty or wet window.
 Light reflects off the subject.	 Two subjects at different distances overlap in the same scene.
 Subject has fine, repeated patterns.	 Subjects at different distances appear in the centre of the scene at the same time.
 Fast-speed shutter being used under fluorescent lighting.	

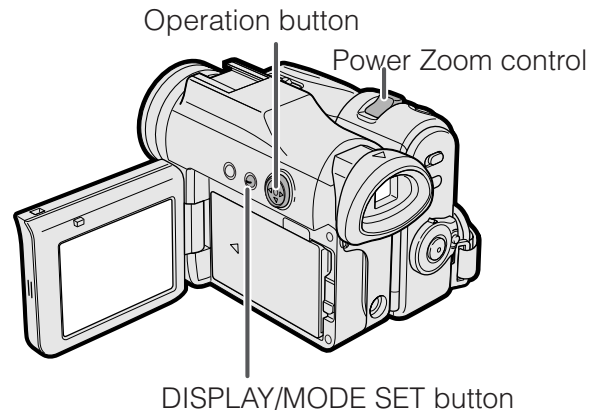

- The example screens shown are for Tape Camera mode.
- 1 In Tape Camera or Card Camera mode, press the DISPLAY/MODE SET button until the mode screen appears.
 - 2 Press ∇ or Δ on the Operation button to select "FOCUS", then press the centre of the Operation button.

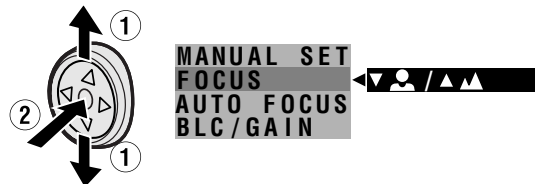

- 3 Adjust the Power Zoom control to frame the subject as you desire.
- 4 Press ∇ or Δ to focus on the subject.
 - ∇ : To focus on a closer subject
 - Δ : To focus on a more distant subject
- 5 Press the DISPLAY/MODE SET button to turn off the mode screen.
 - "MF" appears when the on-screen indicators are turned on.

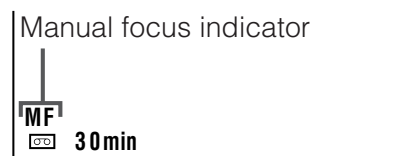

Note:

- When "MF" is displayed, you can manually adjust the focus by pressing ∇ or Δ , even if the focus setting screen is not displayed.

Advanced Features

Camera Recording

Returning to Auto Focus

Available modes:

Tape Camera, Card Camera

You can set Manual Focus mode to Auto Focus mode with the operation below.

- The example screens shown are for Tape Camera mode.

- In Tape Camera or Card Camera mode, press the DISPLAY/MODE SET button until the mode screen appears.
- Press ∇ or Δ on the Operation button to select "AUTO FOCUS", then press the centre of the Operation button.

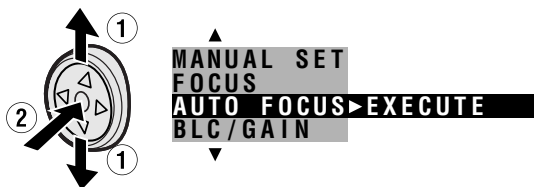

- The FOCUS setting returns to Auto Focus mode.

Note:

- You can return to Auto Focus mode when you press \triangleleft after selecting "FOCUS".

- Press the DISPLAY/MODE SET button to turn off the mode screen.

Displaying the Manual Setting Screen

Available modes:

Tape Camera, Card Camera

You can manually adjust these settings as shown below in the manual setting screen.

- White Balance (see pages 59, 60)
 - Manual Iris (see page 61)
 - Manual Gain (see page 62)
 - Shutter speed (see pages 63, 64)
- The example screens shown are for Tape Camera mode.

- In Tape Camera or Card Camera mode, press the DISPLAY/MODE SET button until the mode screen appears.
- Press ∇ or Δ on the Operation button to select "MANUAL SET", then press the centre of the Operation button.

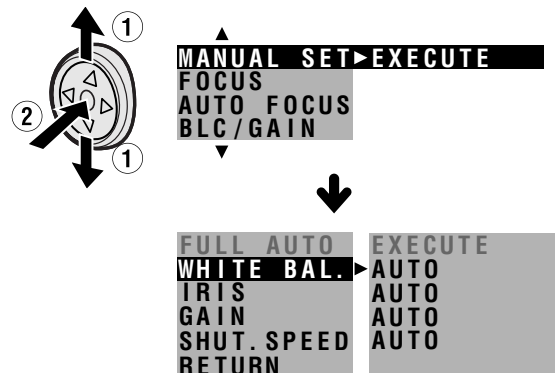

Notes:

- Tape Camera and Card Camera mode do not share manual settings.
- Items that are not selectable are greyed out.
- "MANUAL SET" cannot be selected when a scene setting is selected.

Adjusting White Balance

Available modes:

Tape Camera, Card Camera

The colour of the subject on the screen looks different depending on lighting conditions. Selecting a White Balance setting that matches the lighting conditions.

Types

AUTO: Colouring adjusted automatically for the current lighting condition.

LOCK MODE: Fix the setting to the standard balance (White Balance Lock).

OUTDOOR: For recording outdoors on a sunny day.

INDOOR: For recording indoors with halogen lamps or incandescent lighting.

Selecting

- 1 In Tape Camera or Card Camera mode, press the DISPLAY/MODE SET button until the mode screen appears.
- 2 Press ∇ or \triangle on the Operation button to select "MANUAL SET", then press the centre of the Operation button (see page 58).

- 3 Press ∇ or \triangle to select "WHITE BAL.", then press the centre of the Operation button.

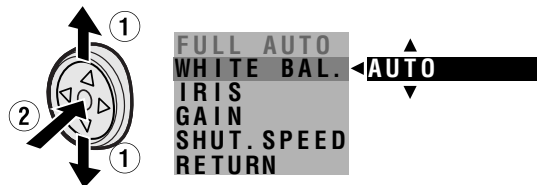

- 4 Press ∇ or \triangle to select a white balance setting, then press the centre of the Operation button.

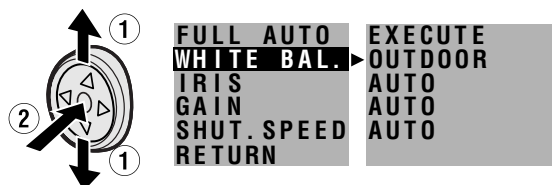

- When selecting "LOCK MODE", perform the steps in "Locking" on the next page.

- 5 Press the DISPLAY/MODE SET button to turn off the MANUAL SET screen.

Advanced Features

Camera Recording

Locking

- 1 Select "LOCK MODE" in step 4 in "Selecting" on the previous page.
- 2 Aim the lens at a white object.
 - Adjust the distance of the object so that the entire screen is white.

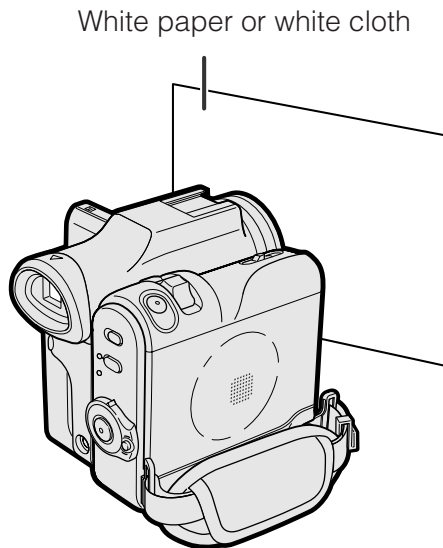

- 3 Press the centre of the Operation button to set the white balance lock.
 - "LOCK MODE" will change to "LOCK" after pressing the centre of the Operation button.
 - "LOCK" flashes during the locking procedure, and stops flashing after locking the white balance.

Note:

- If you move the camcorder while "LOCK" is flashing, "LOCK" may not stop flashing. If this occurs, repeat step 3.

- 4 Press the DISPLAY/MODE SET button to turn off the MANUAL SET screen.

To return to Auto White Balance mode

Press < in step 4 in "Selecting" on the previous page or step 3 in "Locking" to display "AUTO".

To return to Full Auto mode

Set the camcorder to Full Auto mode (see page 64).

Note:

- **White Balance setting cannot be used when a scene setting is selected.**

Manual Iris

Available modes:

Tape Camera, Card Camera

The camcorder is preset to Auto Iris mode, which automatically selects the optimal aperture. However, when there is too much contrast in brightness between the subject and background, you may not be able to record a clear image. In this case, use the manual iris function to correct the iris value.

Background is too bright and subject too dark (backlit subject).

- Decrease the iris value to allow more light through the lens.

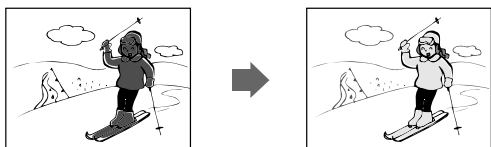

Subject is too bright against background.

- Increase the iris value to allow less light through the lens.

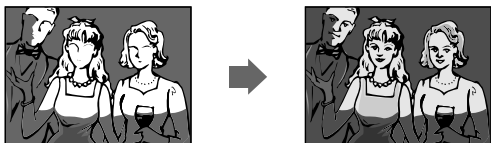

- 1** In Tape Camera or Card Camera mode, press the DISPLAY/MODE SET button until the mode screen appears.
- 2** Press ∇ or Δ on the Operation button to select “MANUAL SET”, then press the centre of the Operation button (see page 58).

- 3** Press ∇ or Δ to select “IRIS”, then press the centre of the Operation button.



- 4** Press ∇ or Δ to select the desired iris value, then press the centre of the Operation button.

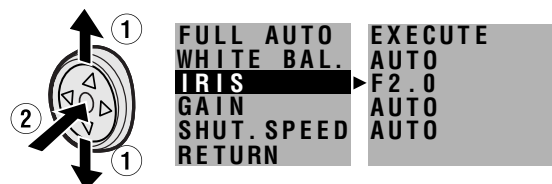

- The number shown is the selected iris value. The adjustment range is 15 steps from F1.8 (most light) to F19 (least light).

- 5** Press the DISPLAY/MODE SET button to turn off the MANUAL SET screen.

To return to Auto Iris mode

Press \triangleleft in step 4 above to display “AUTO”.

To return to Full Auto mode

Set the camcorder to Full Auto mode (see page 64).

Note:

- Manual Iris mode cannot be used when a scene setting is selected.

Advanced Features

Camera Recording

Manual Gain

Available modes:

Tape Camera, Card Camera

When recording in a dark or poorly illuminated location with Auto Gain mode, the light sensitivity of the camcorder (gain) will be automatically adjusted and the recorded image may be brighter than the subject actually is. If you want to faithfully record a dark scene in this case, use the manual gain function. You can also adjust the gain to record a backlit subject brighter.

Example of use

Faithfully recording a dark scene

- Select a smaller gain value (to decrease the light sensitivity).

Background is too bright and subject is too dark (backlit subject)

- Select a larger gain value (to increase the light sensitivity).

- 1** In Tape Camera or Card Camera mode, press the DISPLAY/MODE SET button until the mode screen appears.
- 2** Press ∇ or \triangle on the Operation button to select "MANUAL SET", then press the centre of the Operation button (see page 58).

- 3** Press ∇ or \triangle to select "GAIN", then press the centre of the Operation button.

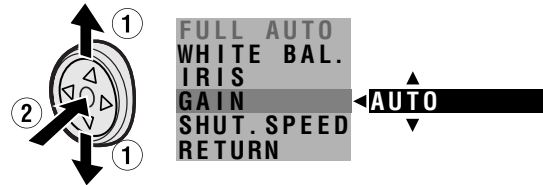

- 4** Press ∇ or \triangle to select the desired gain value, then press the centre of the Operation button.

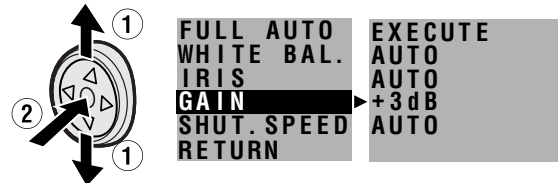

- The number shown is the selected gain value. The adjustment range is 7 steps from 0dB (lowest sensitivity) to +18dB (highest sensitivity).

Note: If you select a large gain value, the image may appear grainy.

- 5** Press the DISPLAY/MODE SET button to turn off the MANUAL SET screen.

To return to Auto Gain mode

Press \triangleleft in step 4 above to display "AUTO".

To return to Full Auto mode

Set the camcorder to Full Auto mode (see page 64).

Note:

- Manual Gain mode cannot be used when a scene setting is selected.

Setting the Shutter Speed

Available modes:

Tape Camera, Card Camera

The shutter speed is preset to auto mode, which automatically selects the optimal shutter speed for the ambient light. However, depending on the subject or situation, you may want to set the shutter speed manually to create a high-quality picture.

- 1 In Tape Camera or Card Camera mode, press the DISPLAY/MODE SET button until the mode screen appears.
- 2 Press ∇ or Δ on the Operation button to select "MANUAL SET", then press the centre of the Operation button (see page 58).
- 3 Press ∇ or Δ to select "SHUT.SPEED", then press the centre of the Operation button.

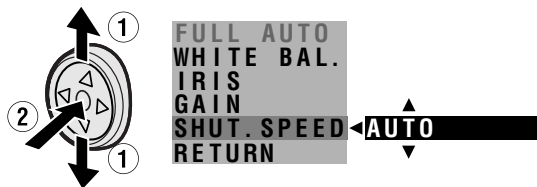

- 4 Press ∇ or Δ to select the desired shutter speed, then press the centre of the Operation button.

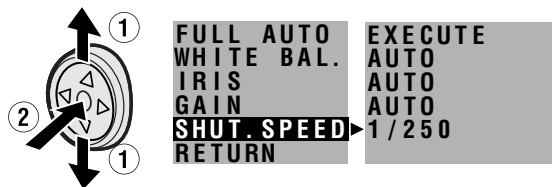

- In Tape Camera mode, you can select 18 speeds from 1/12 sec. ("1/12") to 1/10,000 sec. ("1/10000").
- In Card Camera mode, you can select 10 speeds from 1/12 sec. ("1/12") to 1/500 sec. ("1/500").

- 5 Press the DISPLAY/MODE SET button to turn off the MANUAL SET screen.

To return to Auto Shutter Speed mode

Press \triangleleft in step 4 above to display "AUTO".

To return to Full Auto mode

Set the camcorder to Full Auto mode (see page 64).

Recommended Shutter Speeds

The faster the shutter speed, the darker the picture becomes. Select the most appropriate shutter speed for the ambient light.

Situation	Recommended shutter speed
<ul style="list-style-type: none"> • Recording sports action in bright daylight. • Recording in bright daylight at a ski resort. 	1/10,000 sec. 1/1,000 sec.
<ul style="list-style-type: none"> • Recording outdoor sports on a partially cloudy day. • Recording an outside scene through a car window (when you want to minimize blur caused by the camera shaking). 	1/1,000 sec. 1/250 sec.
<ul style="list-style-type: none"> • When you want to reduce the light by half. Use as a substitute for an ND2 filter. 	1/120 sec.
<ul style="list-style-type: none"> • Recording in a poorly-illuminated location. • When you want to create artistic trailing images of fast-moving subjects. 	1/25 sec. 1/12 sec.



Advanced Features

Camera Recording

Tips on Using the Manual Shutter Speed

- Fast shutter speeds can be used with the still recording functions (see pages 41 and 75) to record higher quality still images of fast-moving subjects.
- If the on-screen picture flickers when recording under fluorescent lighting, you may be able to compensate by setting the shutter speed to 1/120 sec.

Notes:

- Recording with a shutter speed faster than 1/50 sec. tends to darken the picture. Record in bright locations when you use a fast shutter speed.
- Using a fast shutter speed under fluorescent lighting will cause flickering in the picture and possibly periodic colour shifts.
- When selecting 1/25 sec. or 1/12 sec. shutter speed, you may get a shadow image behind a subject that is moving around a lot.
- **The Manual Shutter Speed setting cannot be used when a scene setting is selected or the  indicator appears.**
- **The shutter speed will be set to AUTO when selecting "ON " in gain-up function.**

Tips on Manual Settings

Available modes:

Tape Camera, Card Camera

When the mode or menu screen is off, press and hold down the centre of the Operation button until the screen shown as below appears. You can set focus, white balance, iris, gain and shutter speed manually.

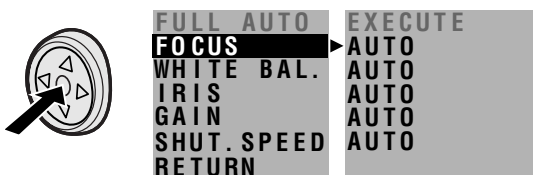

Setting the Camcorder to Full Auto Mode

Available modes:

Tape Camera, Card Camera

You can set all the settings shown in the screen to Full Auto mode in one operation.

- 1 In Tape Camera or Card Camera mode, press the DISPLAY/MODE SET button until the mode screen appears.
- 2 Press ∇ or Δ on the Operation button to select "MANUAL SET", then press the centre of the Operation button (see page 58).

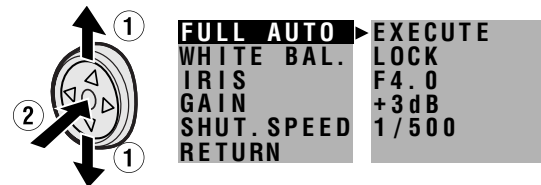

- 3 Press ∇ or Δ to select "FULL AUTO", then press the centre of the Operation button.



- 4 Press ∇ or Δ to select "EXECUTE", then press the centre of the Operation button.

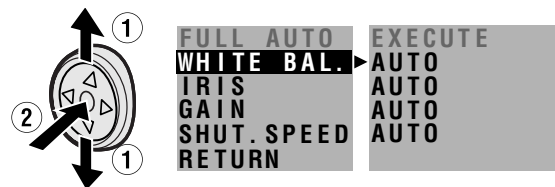

- 5 Press the DISPLAY/MODE SET button to turn off the MANUAL SET screen.

Note:

- You cannot select "FULL AUTO" when no manual settings are currently in use.

Scene Menu (Program AE)

Available modes:

Tape Camera, Card Camera

You can set the camcorder to a shooting mode that will create the best results for a specific situation. Just select one of the six scene settings shown below. The camcorder will automatically set the exposure, white balance, and shutter speed to produce the optimum picture quality for the selected situation.

Types

SPORT (🏃): When you want to record a fast-moving subject.

DUSK (🌇): When you want to faithfully record the red of the setting sun, and the surrounding twilight.

SUNLIGHT (☀️): When background is very bright.

PARTY (🎉): When the illumination is from a spotlight or candle.

NIGHT LUMI (🌃): When you want to record fireworks or an illuminated object in the dark.

SLOW SHUT. (📷): When you want to record an object in a dim place and make it emerge brightly.

- The example screens shown are for Tape Camera mode.

- In Tape Camera or Card Camera mode, press the DISPLAY/MODE SET button until the mode screen appears.
- Press ∇ or Δ on the Operation button to select "SCENE MENU", then press the centre of the Operation button.



- Press ∇ or Δ to select the scene setting that best fits the recording situation, then press the centre of the Operation button.
 - The selected scene setting displays on the mode screen.

SCENE MENU ▶ DUSK

- Press the DISPLAY/MODE SET button to turn off the mode screen.
 - The selected scene setting indicator displays when the on-screen indicators are turned on.

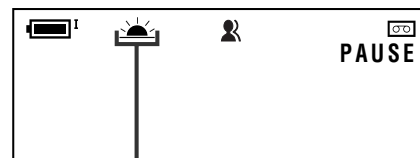

Scene setting indicator

To cancel the scene setting

Select "OFF" in step 3 above.

Note:

- Scene settings cannot be used when using any manual setting except focus. Also not selectable when ∞ displays.

Advanced Features

Camera Recording

Digital Picture Effects

Available mode:
Tape Camera

These digital picture effects let you record the subject with a more dramatic effect.

Types

B/W: To record in black-and-white.

SEPIA: To record in sepia colour similar to that of an old photograph.

SOLARI: To record with enhanced contrast, creating a unique artistic image.

NEGA: To record a picture whose blacks and whites of the image are reversed and colours of the image are inverted.

- 1 In Tape Camera mode, press the DISPLAY/MODE SET button until the mode screen appears.
- 2 Press ∇ or Δ on the Operation button to select "PIC.EFFECT", then press the centre of the Operation button.

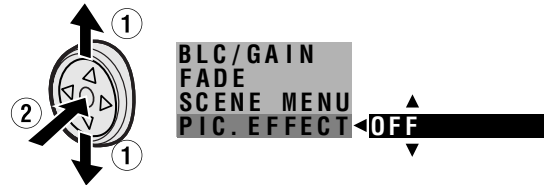

- 3 Press ∇ or Δ to select the desired digital picture effect, then press the centre of the Operation button.

PIC. EFFECT ▶ B/W

- 4 Press the DISPLAY/MODE SET button to turn off the mode screen.

To cancel the digital picture effect

Select "OFF" in step 3 above.

Note:

- Digital picture effects will not work when a still image is displayed.

Advanced Features

Playback

Using the Time Code

Available modes:

Tape Camera, Tape Playback

The time code shows the hour, minute and second of recording, and the frame number (1 frame = approx. 1/25 sec.). This is automatically recorded along with the subject when you are recording on the tape. You can display the time code on the screen as an accurate counter in both Tape Playback and Tape Camera modes.

Display format

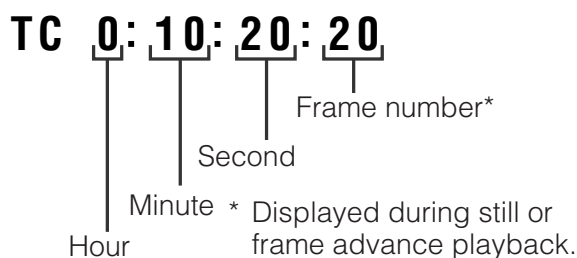

- The example screens shown are for Tape Playback mode.

- During playback or camera recording in Tape mode, press the MENU button to display the menu screen.
- Press ∇ or Δ on the Operation button to select $\checkmark 2$, then press the centre of the Operation button.
- Press ∇ or Δ to select "TIME CODE", then press the centre of the Operation button.

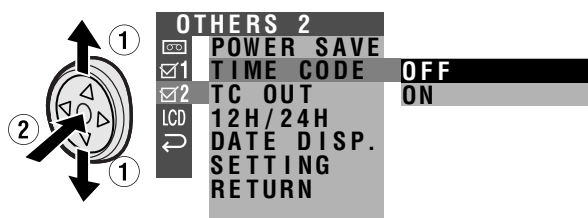

- Press ∇ or Δ to select "ON", then press the centre of the Operation button.

TIME CODE ON

- Press the MENU button to turn off the menu screen.

- The time code appears when the on-screen indicators are turned on.

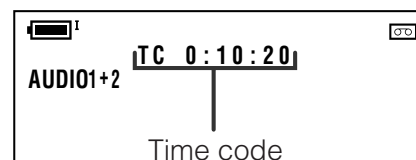

To turn off the time code

Select "OFF" in step 4 above.

Notes:

- When the tape reaches an unrecorded section, the time code returns to zero (TC 0:00:00). Once recorded, the time code cannot be changed.
- You can also press the T/C button on the remote control to display the time code.

Displaying the time code on a TV during playback

- In Tape Playback mode, press the MENU button to display the menu screen.
- Press ∇ or Δ on the Operation button to select $\checkmark 2$, then press the centre of the Operation button.
- Press ∇ or Δ to select "TC OUT", then press the centre of the Operation button.

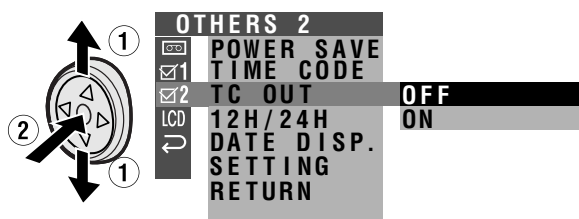

- Press ∇ or Δ to select "ON", then press the centre of the Operation button.

TC OUT ON

- Press the MENU button to turn off the menu screen.

Advanced Features Playback

Audio Dubbing Feature

Available mode:

Tape Playback

You can add narration to recordings made with this camcorder, while preserving the original audio and video recordings.

Microphone for Audio Dubbing

You can use the built-in stereo microphone to record narration.

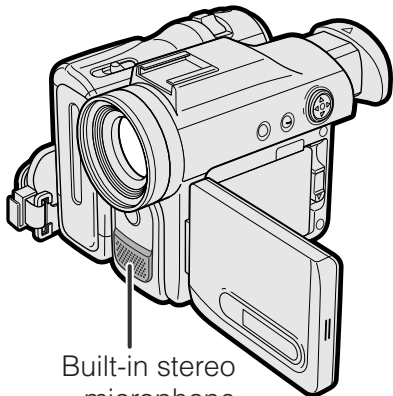

Built-in stereo
microphone

Notes:

- Audio dubbing does not function through the DV terminal.
- You cannot use audio dubbing with recordings made in LP mode.
- You cannot use the built-in stereo microphone for audio dubbing when the audio/video/S-video cable is connected.
- You cannot use the zoom microphone to record narration.

Audio Recording

In normal recording mode

12-bit audio recording

The audio is recorded in stereo on Audio 1.

Audio 1: Stereo (left and right) sound

Audio 2: No audio

16-bit audio recording

The audio is recorded in stereo with the left and right sound on two separate channels.

Audio 1: Left sound

Audio 2: Right sound

In Audio Dubbing mode

12-bit audio recording

The dubbed audio is recorded on Audio 2.

Audio 1: Original stereo (left and right) sound

Audio 2: Dubbed stereo (left and right) sound

16-bit audio recording

The dubbed audio is recorded on Audio 2 over the original right sound. Both dubbed and original sounds are mono.

Audio 1: Original left sound

Audio 2: Dubbed sound

Notes:

- You can select the 12-bit or 16-bit audio recording mode by performing the procedure on page 47.
- You can perform audio dubbing, such as music, on Audio 2 if you connect another source via the AV cable. If the audio to be dubbed was recorded in 12-bit audio recording mode, it can be recorded on Audio 2 in stereo sound.

Audio Dubbing

- 1 Play back the Mini DV cassette recorded in SP mode and locate the tape position where you wish to start audio dubbing.
- 2 Press Δ on the Operation button to pause playback.
- 3 Press the DISPLAY/MODE SET button until the mode screen appears.
- 4 Press ∇ or Δ to select "AUDIO DUB", then press the centre of the Operation button.
 - The audio dubbing screen appears.

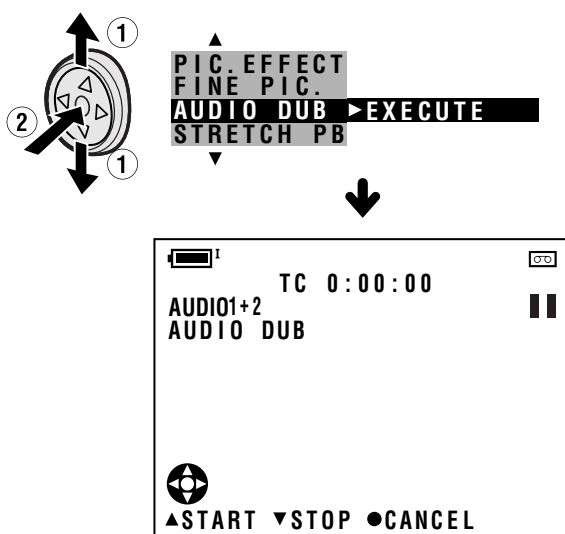

- 5 Press Δ to begin audio dubbing. Record your narration.

To pause audio dubbing

Press ∇ . To resume audio dubbing, press Δ again.

To cancel audio dubbing

Press the centre of the Operation button in step 4. The audio dubbing screen disappears.

If you wish to change the dubbed audio or dub additional scenes

- 1 Press the DISPLAY/MODE SET button to turn off the audio dubbing screen.
- 2 Repeat steps 1 to 5 above.

Notes:

- It is recommended that you use Audio Dubbing only with recordings made with this camcorder. Use of recordings made with other digital video equipment may result in poor audio quality.
- Audio dubbing will automatically pause if the original audio changes from 12-bit mode to 16-bit mode or vice versa. Press Δ to resume operation.
- Audio dubbing will automatically stop if a portion recorded in LP mode or an unrecorded portion of the tape is encountered.
- You can play back the dubbed audio and the original audio together or separately (see page 70).
- "AUDIO DUB" cannot be selected when the Mini DV cassette is recorded in LP mode.

Advanced Features Playback

Selecting the Audio Playback Mode

Available mode:
Tape Playback

You can select any of the following audio playback modes.

Audio 1 + 2

- 12-bit recording in stereo (Audio 1 and Audio 2 channels)
- 16-bit recording in stereo (left and right channels)

Audio 1

- 12-bit recording in stereo (Audio 1 channel only)
- 16-bit recording in mono (left channel only)

Audio 2

- 12-bit recording in stereo (Audio 2 channel only)
- 16-bit recording in mono (right channel only)

- 1 Playback a Mini DV cassette with dubbed audio.
- 2 Press the MENU button to display the menu screen.

- 3 Press ∇ or Δ on the Operation button to select , then press the centre of the Operation button.
- 4 Press ∇ or Δ to select "AUDIO", then press the centre of the Operation button.

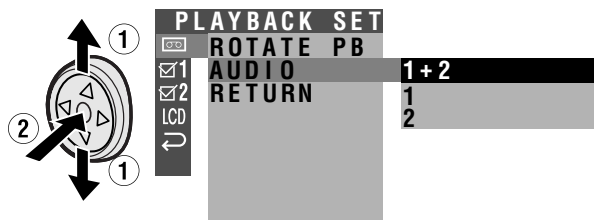

- 5 Press ∇ or Δ to select the desired audio playback mode, then press the centre of the Operation button.

AUDIO 1+2

- 6 Press the MENU button to turn off the menu screen.
 - The selected audio playback mode indicator only appears when the on-screen indicators are turned on.



Audio playback mode indicator

Note:

- The audio playback mode indicator, "AUDIO", displays in different colours depending on the recording mode (12- or 16-bit) used for the recording being played back. A white display indicates 12-bit recording mode, while a green indicates 16-bit.

Editing

Available mode:

Tape Playback

Video editing lets you refine your videos by removing unwanted sequences from your tape, or transposing one sequence with another.

This camcorder lets you monitor the source program on the built-in LCD monitor without having to connect it to an external TV or video monitor.

Preparation

Connect the camcorder to a VCR with the supplied audio/video/S-video cable, as shown.

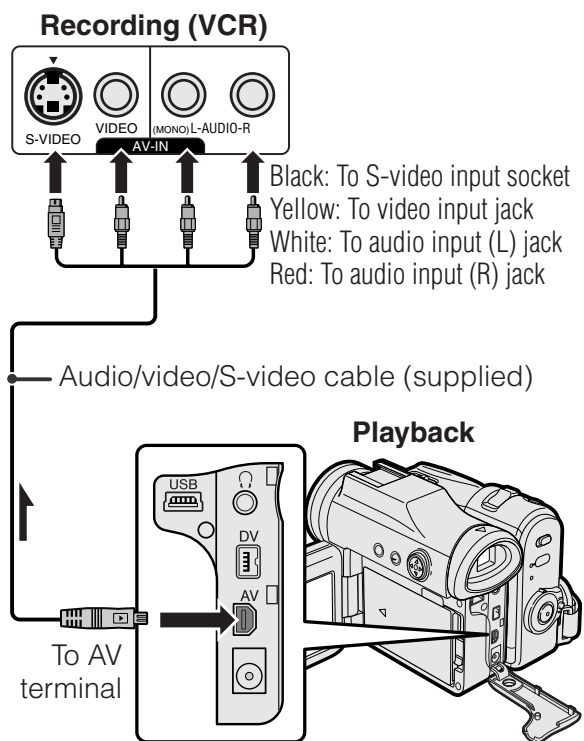

←: The arrow shows the signal flow.

Notes:

- If your VCR has a 21-pin Euro-SCART connector, use a commercially available RCA/21-pin Euro-SCART conversion connector.
- See page 2 for how to open the terminal cover.
- If your VCR has only one audio input jack, use the white plug for the audio connection on the VCR.
- If your VCR has an S-video input socket, you do not need to connect the yellow video plug.

Cutting Unwanted Sequences

- 1 Play back the tape to be edited on the camcorder, and locate the beginning and end of the sequence you wish to cut. Write down the time code reading at the beginning and end of that sequence (see page 67). Then, rewind the tape to before the beginning of the portion that you wish to keep.
- 2 Load a video cassette into the recording VCR.
- 3 Press Δ on the camcorder to begin playback, then press the Record button on the VCR to begin recording.
- 4 Press the Pause/Still button on the VCR to pause recording when the source tape reaches the beginning of the sequence to be cut.
- 5 Press the Pause/Still (or Record) button on the VCR to resume recording when the source tape reaches the end of the sequence to be cut.

To stop editing

Press ∇ on the camcorder and press the Stop button on the VCR.

Notes:

- Some of the transitions between edited sequences may be slightly off.
- There may be picture noise during video search or still playback. This does not imply a defect in the camcorder.
- The time code display will be recorded along with the edited sequences if the TC OUT menu item is set to "ON". Set to "OFF" before editing (see page 67).

Advanced Features Playback

Editing with the DV Terminal (IEEE1394)

Available mode:

Tape Playback

This camcorder can be used as a digital video editor. A DV cable transfers all dubbing signals including video and audio directly to the camcorder.

Preparation

Connect the camcorder to video equipment with a DV terminal using a commercially available DV cable.

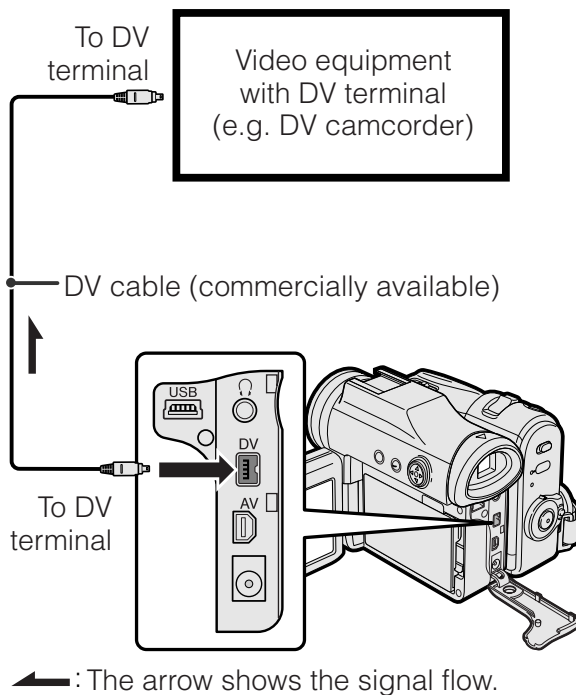

Note:

- See page 2 for how to open the terminal cover.

To Record to Video Equipment

See “Cutting Unwanted Sequences” on page 71 using the video equipment as the recording source.

Notes:

- Make sure that the video equipment to which you are recording can input dubbing signals via the DV terminal.
- When displaying the playback picture on the PC, you may find black bands around the image. This is caused by the differences of the image display sizes.
- “i.LINK” refers to the IEEE1394-1995 industry specification and extensions thereof. The **i** logo is used for products compliant with the i.LINK standard. This “i.LINK” mark is a trademark of Sony Corporation.

Digital Still Camera Features

Camera Recording

Selecting the Picture Quality and Image Size

Available mode:

Card Camera

The picture quality of still images recorded on the card depends on the picture quality and image size setting. Select the appropriate setting to match your recording objectives.

Approximate number of recordable images with the supplied 8 MB SD memory card

Picture quality setting	Approx. number of images		
	1280 × 960	1280 × 720	640 × 480
NORMAL	20	30	90
ECONOMY	40	64	160
FINE	10	14	50

Note:

- The number of recordable images differs depending on the combination of picture quality settings used and the images shot.

Selecting the Picture Quality



The camcorder compresses each image with the picture quality setting to save memory on a card.

Types

NORMAL: Records images with standard picture quality.



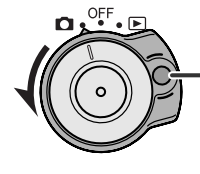
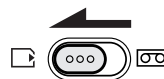

ECONOMY: Allows you to take more shots than in NORMAL mode but with lower quality.

FINE: Records images with higher quality than in NORMAL mode but with lower number of recordable images.



- 1 Set the Media Selection switch to , then hold down the Lock button and set the Power switch to .



Lock button

- 2 In Card Camera mode, press the MENU button to display the menu screen.
- 3 Press  or  on the Operation button to select , then press the centre of the Operation button.
- 4 Press  or  to select "REC MODE", then press the centre of the Operation button.



- 5 Press  or  to select the desired setting, then press the centre of the Operation button.

REC MODE **ECONOMY**

Digital Still Camera Features

Camera Recording

- 6** Press the MENU button to turn off the menu screen.
- The selected picture quality indicator only appears when the on-screen indicators are turned on.



Picture quality indicator

Selecting the Image Size

Still images recorded on a card are made up of pixels. You can select the number of pixels in still images. Larger numbers of pixels provide greater image detail, but also use more card memory.

Types

- 1280 × 960 [1280]:** Images are recorded in 1280 × 960 pixels.
- 1280 × 720 [1280]:** Images are recorded in 1280 × 720 pixels.
- 640 × 480 [640]:** Images are recorded in 640 × 480 pixels.

- 1** In Card Camera mode, press the MENU button to display the menu screen.
- 2** Press ∇ or \triangle on the Operation button to select , then press the centre of the Operation button.

- 3** Press ∇ or \triangle to select "IMAGE SIZE", then press the centre of the Operation button.

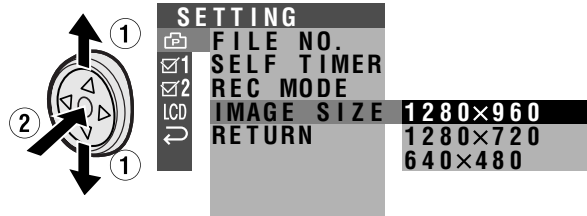

- 4** Press ∇ or \triangle to select the desired setting, then press the centre of the Operation button.

IMAGE SIZE 1280×960

- 5** Press the MENU button to turn off the menu screen.
- The selected image size indicator appears when the on-screen indicators are turned on.

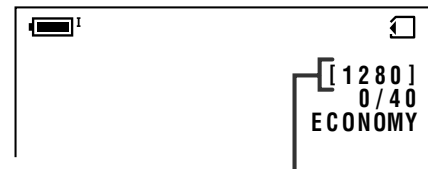

Image size indicator

To record with widescreen aspect ratio of 16:9

Select "1280 × 720" in step 4 above. The black bands will appear on the top and bottom to produce an effective screen aspect ratio of 16:9.



Card Recording

Available mode:

Card Camera

You can take a still picture in the same way as you do with a standard camera and record that image on the card.

PHOTO button

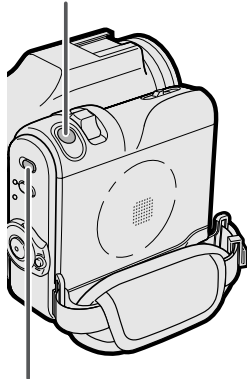

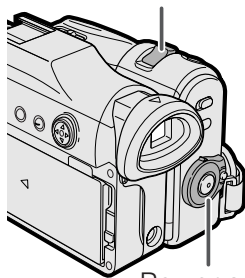

Power Zoom control



Power switch

Media Selection switch

- 1 Insert a card into the camcorder (see page 11).
- 2 Remove the lens cap.
- 3 Set the Media Selection switch to .
- 4 Hold down the Lock button and set the Power switch to .
 - The picture from the lens now displays.

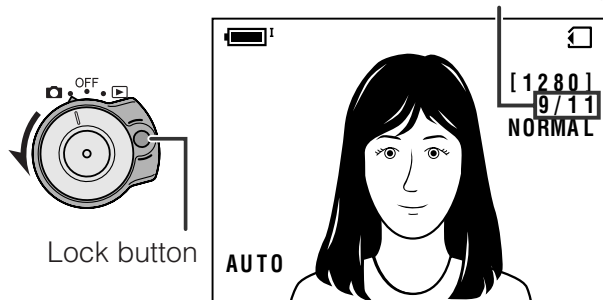

Number of shots taken/remaining



Lock button

- 5 Adjust the Power Zoom control to frame the subject as you desire.

- 6 Press the PHOTO button half-way down to focus on the subject.

- The camcorder automatically focuses on the subject. When it is set, you will hear a sound and see  mark with green light, then the camcorder locks the focus.
- When camcorder locks out of focus,  mark lights up yellow.

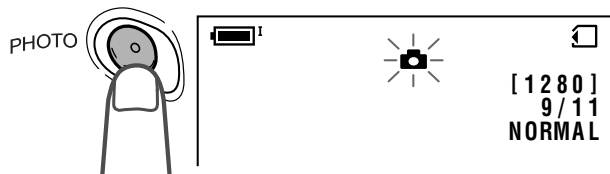

- 7 Press the PHOTO button fully to begin recording.

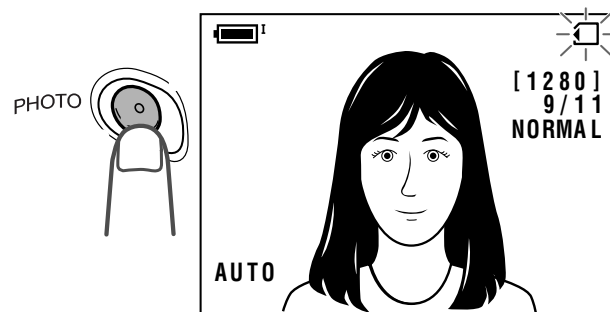

- The  indicator flashes red while data is being recorded on the card, and returns to white when recording completes.
- To record another image, release the PHOTO button and make sure the picture is not frozen in the monitor, then perform steps 6 and 7.

Notes:

- Recording under insufficient lighting may result in blurred images. It is recommended that you use a tripod to record insufficiently illuminated subjects.
- Recording under the light of a fluorescent, mercury, or sodium lamp may cause flickering in the image and, depending on the timing of the shot, may result in changes to colour hue in the image.
- Set the BEEP menu item to "OFF" to turn off the focus locking sound.
- **Do not turn the power off or remove the card while the  indicator is flashing in step 7.**

Recording with the Self-timer

Available mode:
Card Camera

The self-timer function allows you to record images after a time lag. This is convenient when you want to record an image of you and your friends together.



Selecting the time-lag

When you hold the PHOTO button half-way down in 2 SEC mode, the camcorder will lock the focus. This will prevent the camera movement. But it will not lock the focus in 10 SEC mode.

- 1** In Card Camera mode, press the MENU button to display the menu screen.
- 2** Press ∇ or Δ on the Operation button to select , then press the centre of the Operation button.
- 3** Press ∇ or Δ to select "SELF TIMER", then press the centre of the Operation button.



- 4** Press ∇ or Δ to select the desired time-lag, then press the centre of the Operation button.

SELF TIMER 10 SEC



- 5** Press the MENU button to turn off the menu screen.

Recording

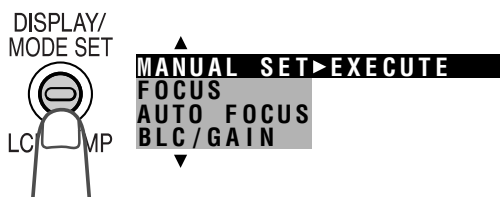
- 1 Select the desired time lag.
- 2 Press the DISPLAY/MODE SET button until the mode screen appears.



- 3 Press ∇ or Δ on the Operation button to select "SELF TIMER", then press the centre of the Operation button.

- The self timer mode indicator,  (10 SEC mode) or  (2 SEC mode), appears.

Self timer mode indicator

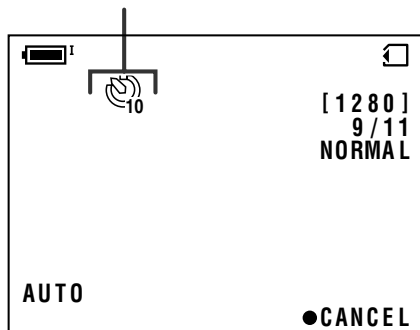

- 4 Press the PHOTO button to start the self-timer.

- The self-timer operating indicator flashes while the timer counts down.

Self-timer operating indicator

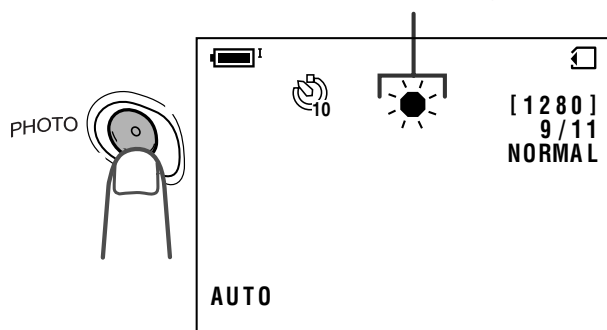

- The shutter automatically releases after the time lag you selected, and a still image of the subject is recorded.

To cancel the countdown

Press the PHOTO button in step 4.

To cancel the self-timer

Press the centre of the Operation button again in step 3.

Notes:

- When recording with the self-timer, stabilize the camcorder in the horizontal plane by attaching it to a tripod, etc.
- Self-timer mode cancels after recording one image. Repeat steps 1 to 4 to record another image with the self-timer.
- Do not turn the power off or remove the card once the self-timer operating indicator begins flashing.

Digital Still Camera Features

Camera Recording

Formatting a Card

Available modes:

Card Camera, Card Playback

Before using a commercially available card with this camcorder, you must first have it formatted. Also, if any of the following warning indicators displays, you will need to format your card.

- “FORMAT MEMORY CARD”
- “MEMORY CARD ERROR”
- “MEMORY CARD READ ERROR”
- “CANNOT STORE DATA”

Notes:

- Formatting a card erases all stored images, including delete-protected images. Be sure to backup important data on your computer or other media before formatting the card (see pages 87–92).
- Do not remove the power source during formatting, as this may cause damage to the camcorder or card. It is recommended that you use the AC outlet for the power supply.

- The example screens shown are for Card Camera mode.

- 1** In Card Camera or Card Playback mode, press the MENU button to display the menu screen.
- 2** Press ∇ or \triangle on the Operation button to select $\checkmark 2$, then press the centre of the Operation button.

- 3** Press ∇ or \triangle to select “FORMAT”, then press the centre of the Operation button.

- To cancel formatting, press ∇ or \triangle to select “RETURN”, then press the centre of the Operation button.

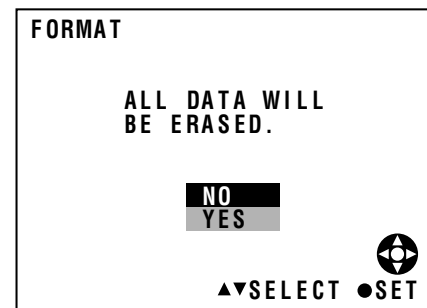
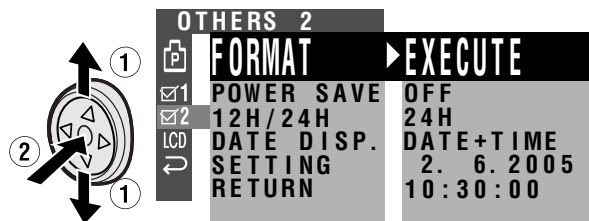

- 4** Press ∇ or \triangle to select “YES”, then press the centre of the Operation button to begin formatting.

- The menu screen displays when formatting finishes.

- 5** Press the MENU button to turn off the menu screen.

Notes:

- The supplied card is preformatted for immediate use.
- **Use this camcorder to format a card. The camcorder may not recognize the images on a card formatted by a computer or other equipment.**

Setting the File Numbering Method

Available mode:
Card Camera

The camcorder automatically assigns file numbers to captured images. You can select two different methods of file numbering.

Types

SERIAL: Defines file numbers by incrementing up from the last image captured when inserting a new card.

RESET: Defines a new set of file numbers when inserting a new card.

- 1 In Card Camera mode, press the MENU button to display the menu screen.
- 2 Press ∇ or \triangle on the Operation button to select \square , then press the centre of the Operation button.
- 3 Press ∇ or \triangle to select "FILE NO.", then press the centre of the Operation button.



- 4 Press ∇ or \triangle to select "SERIAL" or "RESET", then press the centre of the Operation button.

FILE NO. RESET

- 5 Press the MENU button to turn off the menu screen.

Note:

- When a warning indicator "MAXIMUM FILE NUMBER" appears on the screen, set FILE NO. menu item to "RESET", then format the card (see page 78) or replace the card with a new one (see page 11).

Digital Still Camera Features

Playback

Card Playback

Available mode:

Card Playback

You can play back and view still images recorded on a card on the LCD monitor.

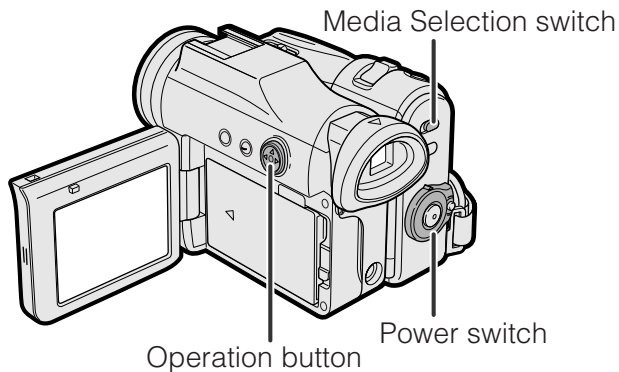

1 Set the Media Selection switch to .

2 Hold down the Lock button and set the Power switch to .

- The images recorded on the card are displayed in a thumbnail format.

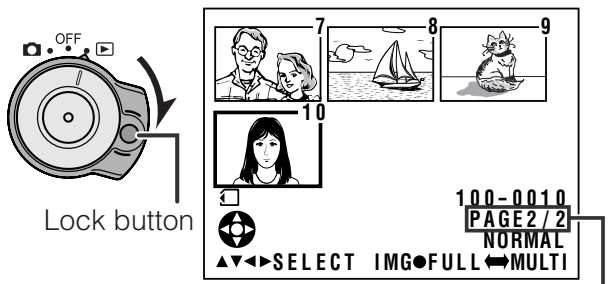

Page number/total thumbnail pages

3 Press \leftarrow , \rightarrow , ∇ or \triangle on the Operation button to move the selection frame to the desired image.

- Each time you press \leftarrow , \rightarrow , ∇ or \triangle , the selection frame moves as shown below.

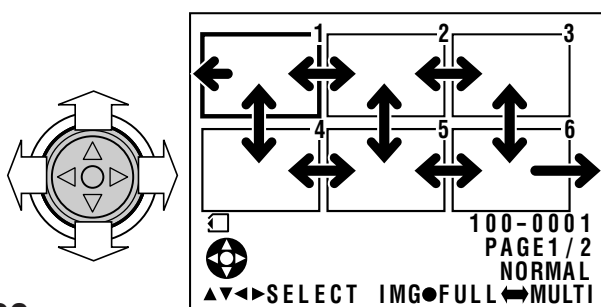

Note:

- Holding down \leftarrow or \rightarrow increases the speed of motion of the selection frame.

4 Press the centre of the Operation button.

- The selected image displays in full-screen.

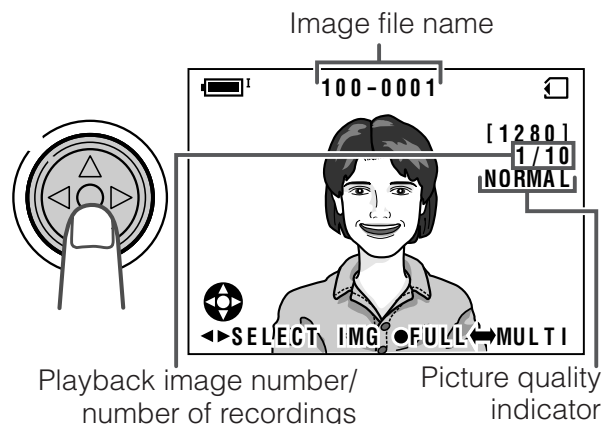

Available Operations during Full-screen Display

- You can display the full-screen picture of the previous or next image by pressing \leftarrow or \rightarrow .
- When holding down \leftarrow or \rightarrow , you can search through the images on the card. The search can be very fast, so it is recommended that the on-screen indicators turns on to display the image number.
- To return to a thumbnail of the images, press the centre of the Operation button again.**

Notes:

- You can also set in the mode screen to display the images in full screen or thumbnails.
- Depending on the amount of image data recorded by a camera other than this camcorder, the picture quality indicator displayed during playback may not match the picture quality setting used during recording.
- The images bigger than 1280×960 , e.g. images recorded on other equipment, display as thumbnails, not full screen.
- Do not play back any card storing a defective image (with noise and distortion) created on other equipment. If you mistakenly play back data on such a card, set the Power switch to OFF, remove, and never use it with this camcorder.

Delete Protection

Available mode:

Card Playback

You can prevent your important images recorded on the card from accidental erasure.

- In Card Playback mode, press the DISPLAY/MODE SET button until the mode screen appears.
- Press ∇ or Δ on the Operation button to select "PROTECT", then press the centre of the Operation button.
 - The PROTECT indicator appears.

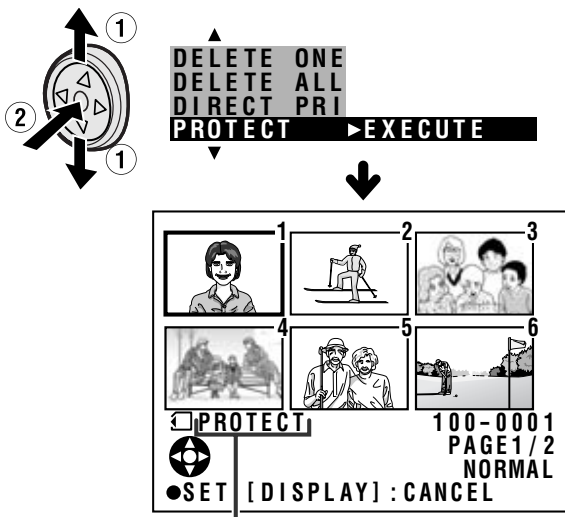

- Press \triangleleft , \triangleright , ∇ or Δ to select the image for delete protection.

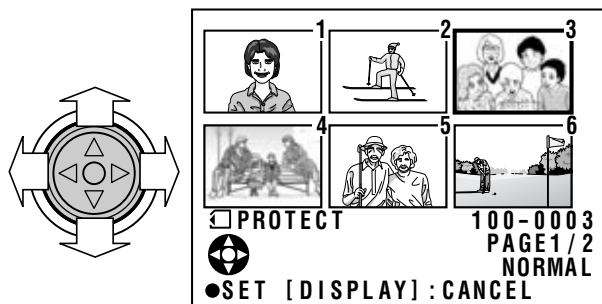

- Press the centre of the Operation button to set delete protection.

- The Ⓞ indicator appears.

Delete protection indicator

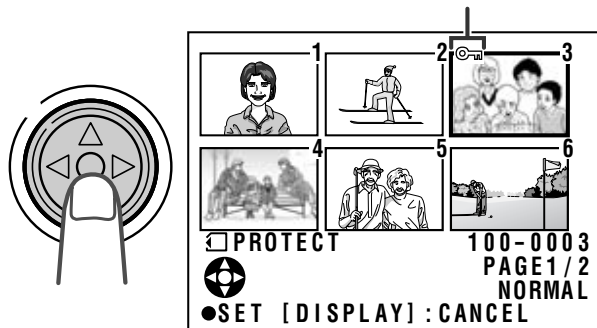

- If you want to protect another image, repeat steps 3 to 4.

- Press the DISPLAY/MODE SET button to finish the setting.

To cancel the protection setting

- Select the image for delete protection cancellation in step 3 above.
- Press the centre of the Operation button to cancel the protection.
 - The Ⓞ indicator disappears.

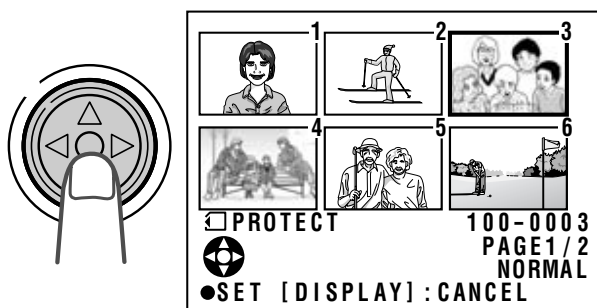

- Press the DISPLAY/MODE SET button to finish the setting.

Note:

- Formatting a card erases all stored images, including delete-protected images.

Digital Still Camera Features Playback

Deleting Stored Images

Available mode:
Card Playback

Deleting One Stored Image

You can delete unwanted images to free up memory of a card for new images.

Note:

- Deleted images cannot be restored. Check whether or not you want the images before performing the procedure below.

- In Card Playback mode, press the DISPLAY/MODE SET button until the mode screen appears.
- Press ∇ or Δ on the Operation button to select "DELETE ONE", then press the centre of the Operation button.
 - The DELETE indicator appears.

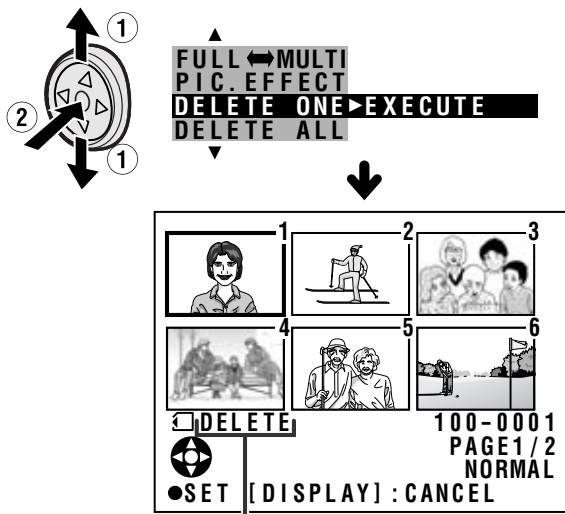

DELETE indicator

- Press \triangleleft , \triangleright , ∇ or Δ to select the image to be deleted.

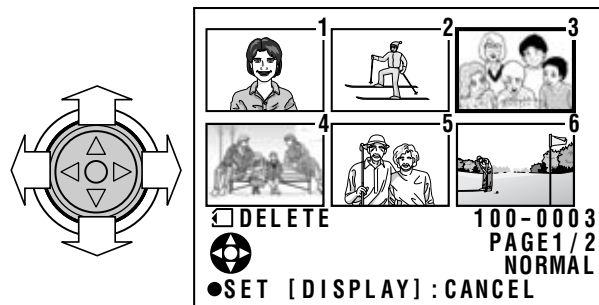

- Press the centre of the Operation button to set the image.
- Press ∇ or Δ to select "YES", then press the centre of the Operation button to delete the image.

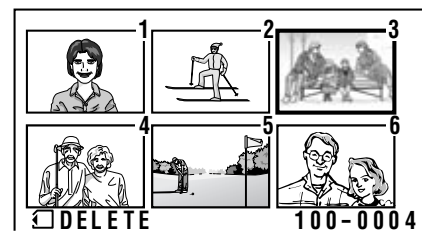
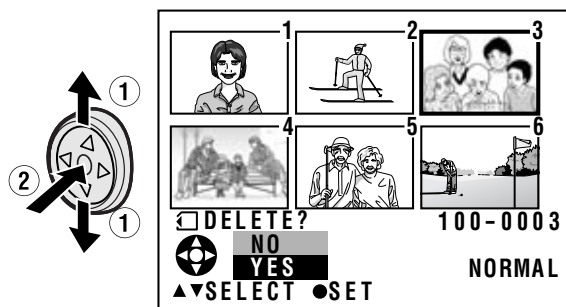

- To cancel the setting, select "NO".
- If you want to delete another image, repeat steps 3 to 5.

- Press the DISPLAY/MODE SET button to finish the setting.

Notes:

- The protected images cannot be deleted. Cancel the protection setting to delete the image (see page 81).
- Do not turn the power off while deleting an image.

Deleting All Stored Images

You can delete all stored images on a card in one operation.

Notes:

- Deleted images cannot be restored. Check whether or not you want the images before performing the procedure below.
- If you want to keep some images on the card, first delete-protect them (see page 81), and then perform the procedure below.

- In Card Playback mode, press the DISPLAY/MODE SET button until the mode screen appears.
- Press ∇ or Δ on the Operation button to select "DELETE ALL", then press the centre of the Operation button.
 - The DELETE ALL? indicator appears.

- Press ∇ or Δ to select "YES", then press the centre of the Operation button.
 - To cancel the setting, select "NO".

- Press the DISPLAY/MODE SET button to finish the setting.

Notes:

- The protected images cannot be deleted. Cancel the protection setting to delete the image (see page 81).
- If a print order is assigned to delete-protected images and you perform the procedure above, the print order will cancel (the protection setting will not cancel).
- It may take several seconds to delete all images from the card.
- Do not turn the power off while deleting images.

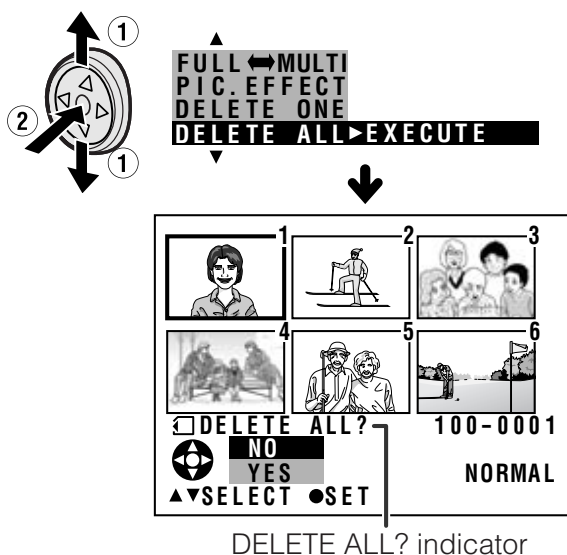

Digital Still Camera Features Playback

Print Order

Available mode:

Card Playback

The print order function allows you to add print information called DPOF to still images recorded on a card.

About DPOF

DPOF (Digital Printing Order Format) defines the print information for the specific images and number of each image on memory cards. In the near future you will be able to easily make prints on a DPOF-compatible printer or order copies at your local print shop.

Note:

- You can print an image even if no print order has been assigned.

Assigning Print Order to an Image

- In Card Playback mode, press the MENU button to display the menu screen.
- Press ∇ or \triangle on the Operation button to select \square , then press the centre of the Operation button.
- Press ∇ or \triangle to select "PRI. ORDER", then press the centre of the Operation button.

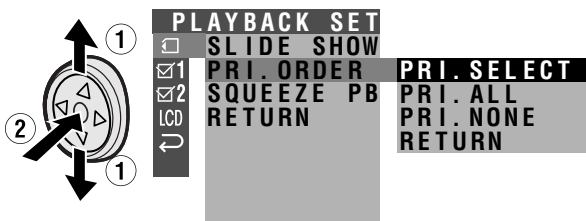

- Press ∇ or \triangle to select "PRI. SELECT", then press the centre of the Operation button.

- The PRINT indicator appears.

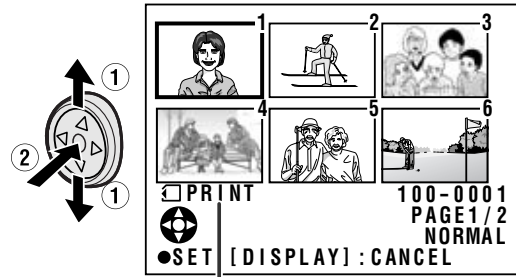

PRINT indicator

- Press \triangleleft , \triangleright , ∇ or \triangle to select the image to which you want to assign a print order.

- Press the centre of the Operation button, then press ∇ or \triangle to select the number of printouts.

- 1 through 99 can be set for the number of printouts.

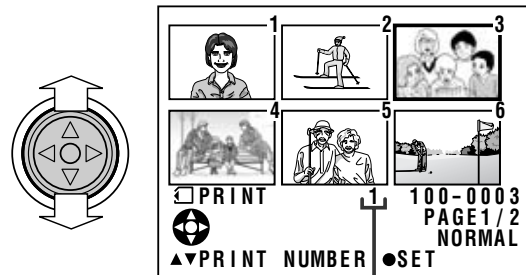

Number of printouts

- Press the centre of the Operation button to set the print order.

- The \square indicator appears.

\square indicator

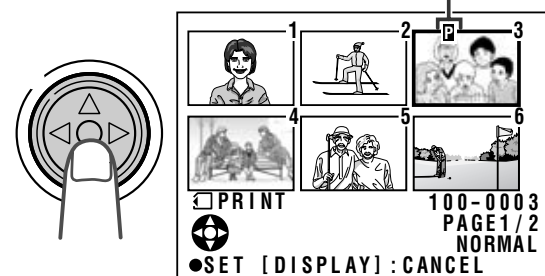

- If you want to assign another print order, repeat steps 5 to 7.

- Press the MENU button to finish the setting.

To cancel the print order for an image

- 1 Select the image for cancelling out of print order in step 5 above, then press the centre of the Operation button.
- 2 Press ∇ to select "0", then press the centre of the Operation button.
 - The \mathbb{P} indicator disappears.

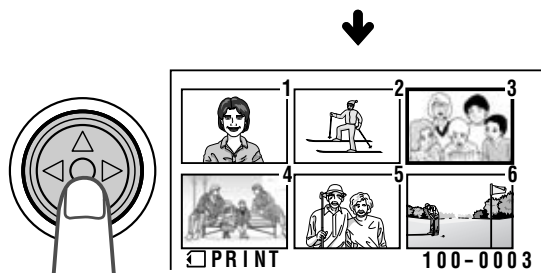
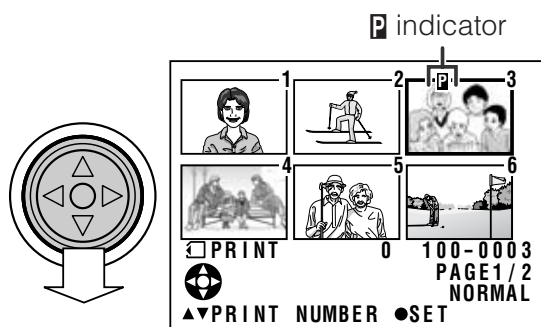

- 3 Press the MENU button to finish the setting.

Assigning Print Order to All Images

- 1 Perform steps 1 to 3 in "Assigning Print Order to an Image".
- 2 Press ∇ or Δ to select "PRI. ALL", then press the centre of the Operation button.

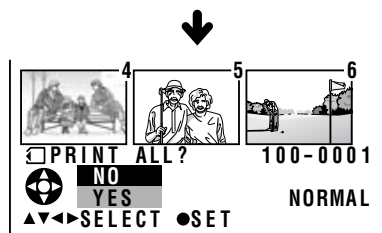
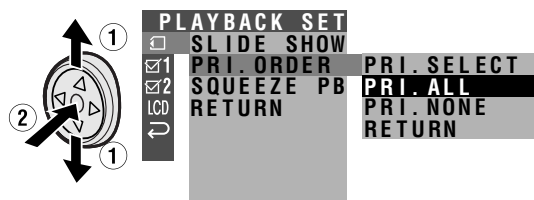

Note:

- A warning indicator appears when the print order is set to more than 999 images. To turn off the warning indicator, press the Operation button.

- 3 Press ∇ or Δ to select "YES", then press the centre of the Operation button.

- The \mathbb{P} indicators appear, and each image is set to 1 print out.
- To cancel the setting, select "NO".

To cancel the print order for all images

- 1 Perform steps 1 to 3 in "Assigning Print Order to an Image".
- 2 Press ∇ or Δ to select "PRI. NONE", then press the centre of the Operation button to cancel the print order for all images.

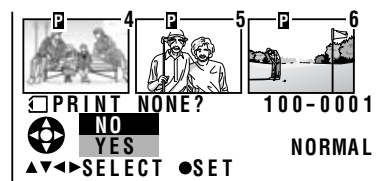
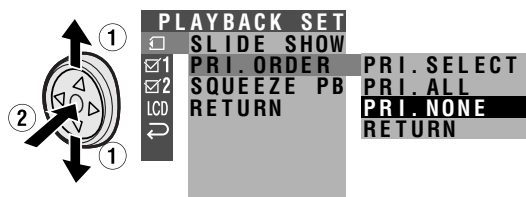

- 3 Press ∇ or Δ to select "YES", then press the centre of the Operation button.

- The \mathbb{P} indicators are turned off.
- To cancel the setting, select "NO".

Digital Still Camera Features Playback

Direct Print



Available modes:

Card Playback

When you connect the camcorder to a Seiko Epson's Direct Print compatible printer, you can print out the recorded still image directly from the printer without computer.

Preparation

Turn on the printer.

- 1 Make sure that the Power switch is set to OFF.
- 2 Connect the camcorder to the printer with the supplied USB cable.
- 3 Set the Media Selection switch to , then hold down the Lock button and set the Power switch to .
- 4 In Card Playback mode, press the DISPLAY/MODE SET button until the mode screen appears.
- 5 Press ∇ or Δ on the Operation button to select "DIRECT PRI", then press the centre of the Operation button.



- 6 Press Δ to select the number of printouts, then press the centre of the Operation button.

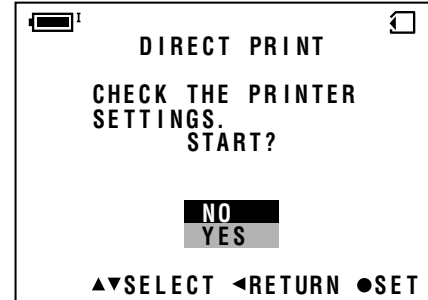

- 7 Press ∇ or Δ to select "YES", then press the centre of the Operation button.
 - Printing begins.
 - To cancel the setting, select "NO".

Notes:

- "INK ERROR" appears when the ink of the printer connected to the camcorder is low. Check the remaining of the printing ink.
- The top and bottom of an image may be cropped depending on the paper size. In this case, set the crop setting of the printer to off. See the printer's operation manual for the details.
- When connecting the camcorder to a printer, "CHECK THE PRINTER SETTINGS." may appear. In this case, disconnect and connect the USB cable before or after printing. If the message still appears, turn off and on the printer.

About PRINT Image Matching II

This product supports PRINT Image Matching II. When used in combination, PRINT Image Matching II enabled digital still cameras, printers and software, help photographers to produce images more faithful to their intentions. PRINT Image Matching is a trademark of Seiko Epson Corporation.

Transferring Data on Card to Computer

To transfer data from the card, first install the software from the supplied CD-ROM. The CD-ROM includes “USB Driver”, “PixLab Media Browser” and other related files.

- “USB Driver” is the software that transfers images from the camcorder when connecting to the PC with the supplied USB cable.
- “PixLab Media Browser” is the software that can copy image files to the computer or can display the files like the way you do with Windows Explorer.

System Requirements

- Operating systems
 - Microsoft® Windows® XP Home Edition/Professional
 - Microsoft® Windows® 2000 Professional
 - Microsoft® Windows® Me
 - Microsoft® Windows® 98 Second Edition
 - 266 MHz or higher MMX Pentium-compatible CPU*¹ (Pentium® II 266 MHz or higher recommended)
(When using Windows® XP: Pentium® II 300 MHz or higher)
 - 64 MB or more of RAM*¹ (128 MB or more recommended) for Windows® 98 or Windows® Me
128 MB or more of RAM*¹ (256 MB or more recommended) for Windows® 2000 or Windows® XP
 - USB terminal
 - CD-ROM drive (for installation)
 - Mouse or other pointing device
 - 800 × 600 pixels or more resolution and 16,777,216 colours (24 bit) or more screen display (recommended)
 - DirectX® 8 or later-compatible video card*²
 - SoundBlaster or SoundBlaster-compatible sound card*¹, compatible with DirectX® 8 or later required*²
 - Software: Microsoft® Internet Explorer 5.5 or 6.0 (typical or full install)
Microsoft® Windows Media™ Format 7.1/DirectX® 8.1*³
 - Approx. 70 MB or more hard disk for installing USB Driver, PixLab Media Browser, Microsoft® DirectX® 8.1, Microsoft® Windows Media™ Format 7.1
- *¹ Depending on the computer's performance and capacity, this software may not provide the expected performance (for example, operation may be extremely slow).
- *² Contact your computer's manufacturer to find out if your video card is compatible with DirectX® 8 or later.
- *³ It will be installed if needed during the installation.

Note:

- The USB driver is not compatible with Macintosh operating systems.

Trademarks

- Microsoft, Windows and Windows Media are either registered trademarks or trademarks of Microsoft Corporation in the United States and/or other countries.
- Adobe, Acrobat, Acrobat Reader and Adobe Reader are trademarks or registered trademarks of Adobe Systems Incorporated.
- DirectX is a trademark of Microsoft Corporation of the United States and is copyrighted.

Digital Still Camera Features

Playback

Installing the USB Driver

For installing the USB driver in Windows XP or Windows 2000, you need to log in as the system administrator.

- 1** Turn on the computer.
 - Do not connect the camcorder to the computer with the USB cable at this point.
- 2** Insert the supplied CD-ROM containing the USB driver into the CD-ROM drive.
 - The License Agreement/Install Key screen will display automatically.

Note:

 - When the License Agreement/Install Key screen does not appear,
 - ① select “Run...” in Windows “start” menu, then
 - ② type “R:\SETUP.EXE”, and then click on the “OK” button.
 - In the example above the CD-ROM drive letter is taken as “R:”. Select the correct drive letter according to your operating environment.
- 3** After reading the License Agreement, enter the Install Key, mentioned on the cover page, and then click the “Yes” button.
 - The Setup screen will display automatically.
 - The example screen shown is for Windows XP.



- 4** Click the “USB Driver” button.
 - Welcome screen appears.
- 5** Click the “Next” button.
 - Information screen appears. Read information.
- 6** Click the “Next” button.
 - Installation begins.
- 7** Confirm the message on the screen, and then click the “Finish” button to complete the installation.

Note:

- If your computer gives you the option to restart, you may do so.

8 Insert a card that contains recorded still images into camcorder.

9 Connect the camcorder to the computer with the supplied USB cable as shown below.

- It is recommended to use the AC adapter as a power source for extended periods of use.
- Connect the USB cable directly to the USB terminal of computer.
- To prevent malfunction, turn off the camcorder when you connect to the computer.

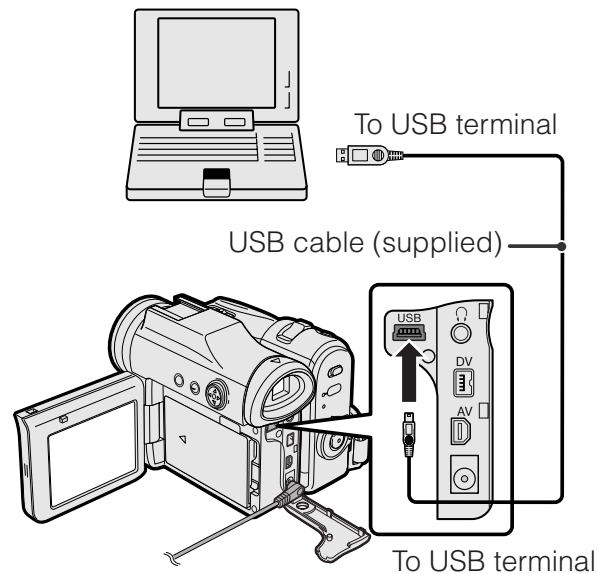

10 Set the Media Selection switch to .

11 Hold down the Lock button and set the Power switch to .

- Computer will recognize the camcorder automatically.

Note:

- If you restart computer after installing the USB driver, remove the CD-ROM and insert it again or click the icon of the CD-ROM on computer's screen.

12 Click the “PixLab Media Browser” button on the Setup screen, and then follow the instructions as they appear on the screen until the installation is completed.

Digital Still Camera Features Playback

Using the PDF Manual

Use of the installed “PixLab Media Browser” is explained in the PDF Operation Manual.

Installing Adobe Reader

Adobe Reader 6.0 (or Adobe Acrobat Reader 4.0 or later) is required for viewing the PDF manual. If it is not installed on your PC, perform steps below to access Adobe homepage and download it.

- 1** Insert the supplied CD-ROM.
- 2** Click the “Open Readme file” button in the Setup screen.
- 3** Read the section “(3-8) Operation Manual” in “(3) Cautions on using PixLab”, then click “To download the Reader follow the link on the next page”.
- 4** Click “Adobe Reader homepage” (or “Adobe Systems Website”) in “Adobe Reader” to access the homepage, then download Adobe Reader.

Opening the PDF Manual

Click on the Windows “start” button and click after moving the pointer to “All Programs”, “PixLab Media Browser Ver4” and “PixLab Media Browser LE Operation Manual”.

- Adobe Reader 6.0 (or Adobe Acrobat Reader 4.0 or later) starts up and the PDF manual opens.

Note:

- If the PDF file does not open, Adobe Reader 6.0 (or Adobe Acrobat Reader 4.0 or later) may not be properly installed. Refer to the steps of “Installing Adobe Reader” to check the installation procedure.

Printing the PDF Manual

Print out the PDF manual so that you can consult it whenever necessary.



- 1** Open the PDF manual.
- 2** Select “Print” in the “File” menu.
- 3** Select your print settings, then click “OK”.

Transferring the data on Card to Computer

Connecting the camcorder to the computer

Connect the camcorder to the computer with the supplied USB cable (see page 89).

Transferring data

- 1 Turn on the computer, then connect the camcorder with the supplied USB cable.
- 2 Set the Media Selection switch to , then hold down the Lock button and set the Power switch to .
- 3 Double click the shortcut icon of PixLab Browser Ver4.
 - PixLab Media Browser will start up.
- 4 Transfer data with PixLab Media Browser.
 - For details about PixLab Media Browser, refer to the online manual and help.

Caution on transferring data

While transferring data, the transfer indicator moves. Do not execute the operations below.

- Disconnecting the USB cable
- Switching the power on/off
- Turning off the PC or setting it to Standby
- Removing the card

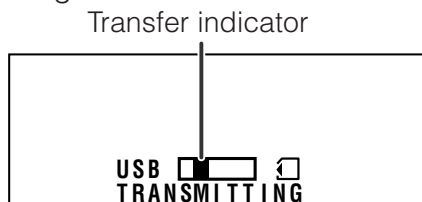

Note:

- In case of data transfer error, disconnect the USB cable, then connect it again, or set the Power switch to OFF, then set it to  again.

Disconnecting the USB cable

Windows Me/2000/XP

- 1 Close PixLab Media Browser.
- 2 Click the “Safely Remove Hardware” (or “Unplug or Eject Hardware”) icon that appears on the task bar, and choose an applicable hard drive to stop.
- 3 After the message “Safe To Remove Hardware” appears, disconnect the USB cable.

Note:

- See Windows Help for the procedure of disconnecting USB cable in detail.

Windows 98

When data is not being transferred (the indicator on LCD display stays still), right-click on the disk drive icon, which appears on explorer window, to eject the disk. After that, disconnect the USB cable.

Digital Still Camera Features Playback

Image Folders and File Names

Double-click the My Computer icon on the PC and find a new drive called "Removable Disk (F:)" (or other drive letter, depending on your PC configuration). Still images recorded using the camcorder are stored in files and on a card as shown below.

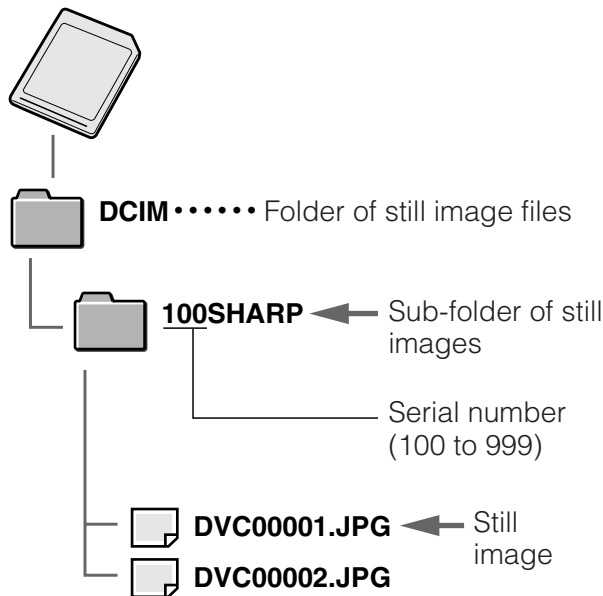

Note:

- If you copy any data incompatible with this camcorder to the card, the camcorder will not be able to recognize it.

Squeeze Playback

Available mode:

Card Playback

When you play back the images recorded with 1280×720 mode on a widescreen TV, the picture quality may decrease. In this case, play back the images with squeeze playback so you can enjoy a high quality picture on the widescreen TV with an effective screen aspect ratio of 16:9.

Note:

- Squeeze playback cannot be used when playing back an image recorded with an image size of 1280×960 or 640×480 (see page 74).

- 1 In Card Playback mode, press the MENU button to display the menu screen.
- 2 Press ∇ or Δ on the Operation button to select \square , then press the centre of the Operation button.
- 3 Press ∇ or Δ to select "SQUEEZE PB", then press the centre of the Operation button.

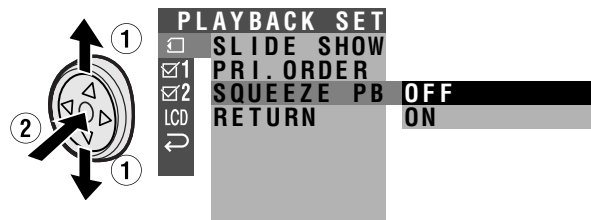

- 4 Press ∇ or Δ to select "ON", then press the centre of the Operation button.

SQUEEZE PB ON

- 5 Press the MENU button to turn off the menu screen.

Note:

- See the operation manual for your widescreen TV about how to display an effective screen aspect ratio of 16:9 on a widescreen TV when outputting the images by squeeze playback from the camcorder.

Slide Show Playback

Available mode:

Card Playback

You can automatically play back consecutive still images recorded on a card at intervals of 5 seconds. This is useful when confirming the data recorded on a card.

- 1 Set the camcorder to Card Playback mode.
- 2 Press ◀, ▶, ▽ or ▲ on the Operation button to select the image from which you want to begin slide show playback.

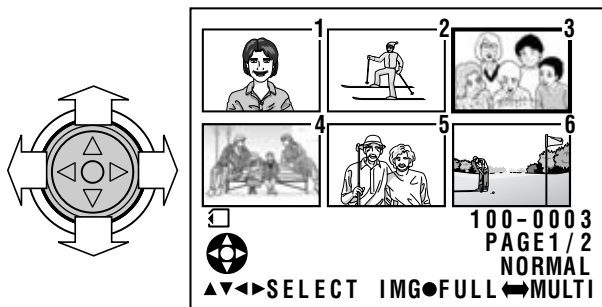

- 3 Press the MENU button to display the menu screen.

- 4 Press ▽ or ▲ to select ◻, then press the centre of the Operation button.
- 5 Press ▽ or ▲ to select "SLIDE SHOW", then press the centre of the Operation button.
 - Beginning from the image selected in step 2, the recorded images will display in full-screen one after another in order of recording.

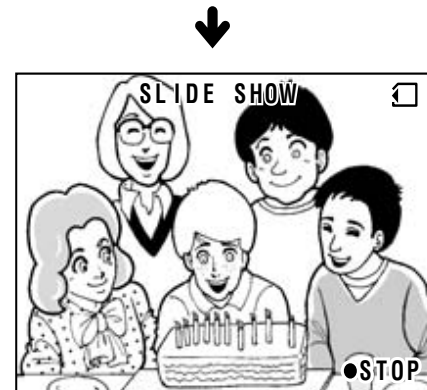
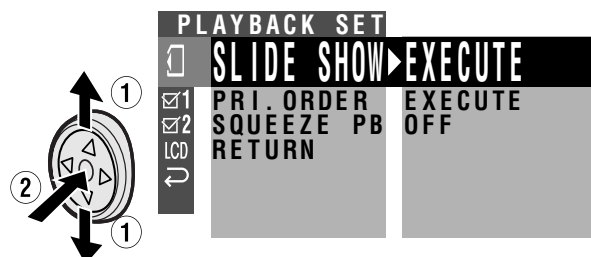

- After playing back all the images on the card once, slide show playback automatically stops.

To stop slide show playback

During slide show playback, press the centre of the Operation button.

Picture/Backlight Adjustments

Available modes:

All modes

If the picture is difficult to see due to ambient light or other factors, adjust the monitor picture settings.

- The example screens shown are for Tape Camera mode.

Adjusting the Picture

- Press the MENU button to display the menu screen.
- Press ∇ or Δ on the Operation button to select LCD, then press the centre of the Operation button.



- Press ∇ or Δ to select "LCD BRIGHT", "LCD COLOUR" or "VF BRIGHT", then press the centre of the Operation button.
 - The viewfinder turns on if you select "VF BRIGHT".
- Press \triangleleft or \triangleright to adjust the item to the desired setting, then press the centre of the Operation button.

LCD BRIGHT -■■■■■■■■■■+
Darker \longleftrightarrow Brighter

LCD COLOUR -■■■■■■■■■■+
Decrease \longleftrightarrow Increase

VF BRIGHT -■■■■■■■■■■+
Darker \longleftrightarrow Brighter

- Press the MENU button to turn off the menu screen.

Note:

- When adjusting the colour, the picture on the LCD monitor may differ from the picture actually recorded. Do not change the colour setting unless necessary. (This adjustment only affects the monitor picture, not the recorded image.)

Adjusting the Backlight

- Press the MENU button to display the menu screen.
- Press ∇ or Δ on the Operation button to select LCD, then press the centre of the Operation button.
- Press ∇ or Δ to select "BACK-LIGHT", then press the centre of the Operation button.



- Press ∇ or Δ to select "NORMAL" or "BRIGHT", then press the centre of the Operation button.

BACKLIGHT **BRIGHT**

NORMAL: For use indoors or under moderate lighting conditions.

BRIGHT: For use outdoors under strong lighting conditions, such as bright daylight.

- Press the MENU button to turn off the menu screen.

Turning off the Confirmation Sound

Available modes:

All modes

A confirmation sound is made when you turn on or off the Power switch, press the Record Start/Stop button, or perform other designated operations. Use the procedure below to turn off the confirmation sounds.

- The example screens shown are for Tape Camera mode.

- Press the MENU button to display the menu screen.
- Press ∇ or Δ on the Operation button to select \checkmark 1, then press the centre of the Operation button.
- Press ∇ or Δ to select "BEEP", then press the centre of the Operation button.

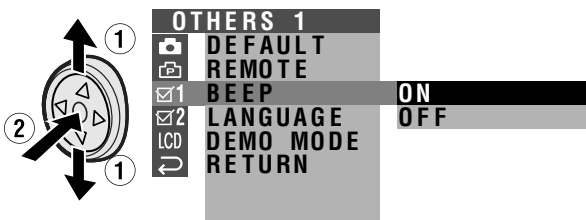

- Press ∇ or Δ to select "OFF", then press the centre of the Operation button.

BEEP OFF

- Press the MENU button to turn off the menu screen.

To turn on the confirmation sound

Select "ON" in step 4 above.

Note:

- If you select "OFF", the focus confirmation sound in Card Camera mode will turn off.

Setting the Camcorder to Factory Presettings

Available modes:

All modes

You can set the camcorder to the factory presettings in one operation.

- The example screens shown are for Tape Camera mode.

- Press the MENU button to display the menu screen.
- Press ∇ or Δ on the Operation button to select \checkmark 1, then press the centre of the Operation button.
- Press ∇ or Δ to select "DEFAULT", then press the centre of the Operation button.

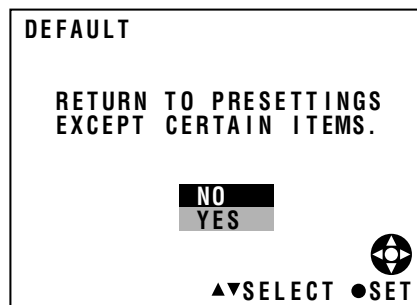
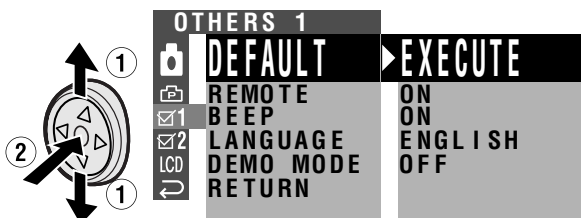

- Press ∇ or Δ to select "YES", then press the centre of the Operation button.
 - To cancel the setting, select "NO".
- Press the MENU button to turn off the menu screen.

Note:

- Even when you perform the steps above, the clock and language settings will remain in the camcorder's memory.

Demonstration Mode

Available modes:

Tape Camera, Card Camera

You can watch a brief demonstration of the special camcorder features in Demo mode. If the demonstration appears on the screen when you turn on the camcorder for the first time, cancel the Demo mode to use your camcorder.

Watching

- The example screens shown are for Tape Camera mode.

- 1 Remove the Mini DV cassette from the camcorder (see page 10).
- 2 In Tape Camera mode or Card Camera mode, press the MENU button to display the menu screen.
- 3 Press ∇ or \triangle on the Operation button to select \checkmark 1, then press the centre of the Operation button.
- 4 Press ∇ or \triangle to select "DEMO MODE", then press the centre of the Operation button.

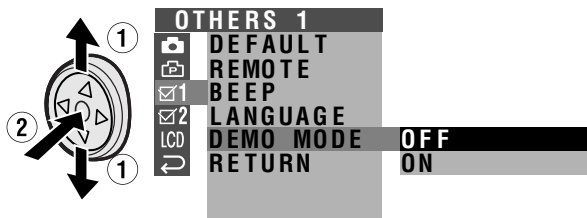

- 5 Press ∇ or \triangle to select "ON", then press the centre of the Operation button.

DEMO MODE ON

- 6 Set the Power switch to OFF, then hold down the Lock button and set the Power switch to \square .
 - The demonstration begins.

Cancelling

- 1 During the demonstration, press the centre of the Operation button to pause the demonstration.
- 2 Perform step 2 to 4 in "Watching", then select "OFF" in step 5.

Notes:

- The demonstration will pause if you press the centre of the Operation button. If you leave it for 60 seconds, or turn the power off temporarily and then set the Power switch to \square , the demonstration will begin again.
- Demonstration mode does not work in self recording with reversed grip.

Useful Information

Hints for Better Shooting

- Position the subject in the centre of the scene. When using auto focus, whatever is in the centre of the scene is kept in focus.



Position the subject in the centre.



Focus manually when you need to position the subject off centre (see page 57).

- Avoid backlit subjects. For the best picture, shoot with the light source behind you.

When the background is brighter than the subject, the subject often becomes too dark. If you have to record in this lighting, use Backlight Compensation or correct the iris value to improve the picture (see pages 35 and 61).

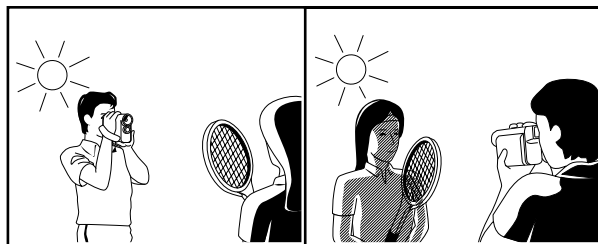

Light from behind

Backlighting

- Before zooming, think about how to best frame the shot. Frequent zooming produces unattractive pictures. It also runs down the battery more quickly.
- When image shaking is noticeable during zoomed-in telephoto shooting, use a tripod or push the Power Zoom control to the W side to zoom out.

- Horizontal panning (lateral movement) and tilting (vertical movement) should be done slowly to emphasize the wide expanse of a scene or the height of a building, and to make scenes easy to watch during playback.
- Use a wide-angle setting for fast-moving subjects.

Note:

- It may take longer to focus when zooming and panning are used frequently.

Mini DV Cassette

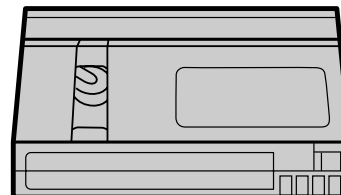

Precautions when using a Mini DV cassette

- Be sure to use only Mini DV cassettes with the ^{Mini}DV mark.
- This camcorder can record and play back using Mini DV cassettes with cassette memory, but it cannot record or play back this memory.
- To record in LP mode, use a Mini DV cassette labelled for use with LP mode.
- Do not insert anything into the holes on the bottom of the Mini DV cassette or block them in any way.
- Avoid placing the Mini DV cassette in areas conducive to dust or mold.
- Do not place the Mini DV cassette near magnetic sources such as electric clocks or magnetic devices as this may adversely affect recorded material.

Appendix

- When a previously recorded Mini DV cassette is used again for recording, the previously recorded material will be automatically erased.
- The Mini DV cassette will not operate if inserted in the wrong direction.
- Do not repeatedly insert and eject the Mini DV cassette without running the tape as this may cause uneven tape winding and damage the tape.
- Do not place the Mini DV cassette in direct sunlight, near strong heat sources, or in areas with excessive steam.
- Store the Mini DV cassette in its case and stand it in an upright position.
- If the tape is not properly wound, rewind the tape.
- Do not drop the Mini DV cassette or subject it to excessive shocks.

To protect recordings against accidental erasure

Slide the protect tab on the rear of the Mini DV cassette to the “SAVE” position.

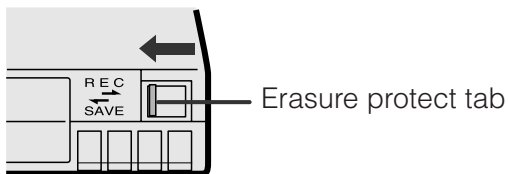

To record over a previously recorded tape, slide the protect tab to the “REC” position.

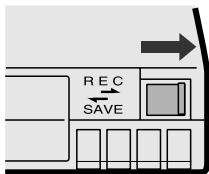

Copyright Protection

The digital VCR has far superior recording and playback ability than the traditional analog VCR, and in order to protect digital video software copyrights, a system for managing copyrights has been established. Some digital video recording with prerecorded copyright protection signals can still be played back on this camcorder. If you play a digital video recording that has a copyright protection signal on video equipment with a DV terminal and attempt to record a copy of that software on this camcorder, “COPYRIGHT PROTECTED.” appears on the screen and the recording is disabled.

This product incorporates copyright protection technology that is protected by method claims of certain U.S. patents and other intellectual property rights owned by Macrovision Corporation and other rights owners. Use of this copyright protection technology must be authorized by Macrovision Corporation, and is intended for home and other limited viewing uses only unless otherwise authorized by Macrovision Corporation. Reverse engineering or disassembly is prohibited.

About a tape recorded with high-definition camcorder

This camcorder cannot play back a tape recorded with high-definition camcorder. If such a tape is played back, the screen becomes blue and the warning indicator, “NOT RECORDED ON DV FORMAT”, will appear.

SD™ Memory Card and MultiMediaCard™

SD (Secure Digital) Memory Cards and MultiMediaCards are small, handy and flexible storage media used in a variety of mobile applications. They are one of the smallest memory solutions available on the market. This camcorder uses either an SD Memory Card or a MultiMediaCard. It cannot use a SmartMedia™ card or Memory Stick®.

SD™ Memory Card

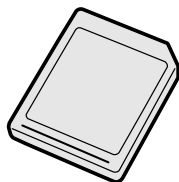

MultiMediaCard™

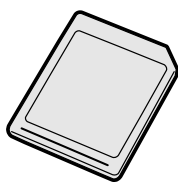

SmartMedia™ card

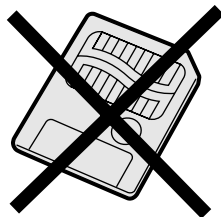

Memory Stick® media

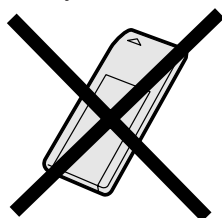

- An SD Memory Card has more advanced features than a MultiMediaCard, including cryptographic security for copyrighted data and a selectable mechanical write-protect switch.
- The card slot on this camcorder is compatible with an SD Memory Card or MultiMediaCard.
- An SD Memory Card and a MultiMediaCard are cross-compatible. Data stored on one can be easily transferred to the other.

Note:

- This camcorder is verified to work properly with the following card memory types.
 - SD Memory Card: 128 MB or less
 - MultiMediaCard: 64 MB or less

Removable Storage Care

Below are some precautions to ensure a long life and perfect performance from your SD Memory Card (SDMC) or MultiMediaCard (MMC). Information specific to one card is attached with the card's acronym (either SDMC or MMC).

Precautions

- Be sure to insert the card in the correct direction. Do not try to force the card in.
- Store the card in its antistatic plastic case when not in use.
- Do not disassemble or modify the card.
- Do not strike, bend or drop the card.
- Do not allow the card to become wet.
- Do not peel off the card label.
- Do not attach other labels or stickers to the card.
- Do not expose to extreme heat sources (e.g. sunlight, heating appliances).
- Do not store in a highly humid or dusty place.
- Do not store in a place exposed to corrosive gas.
- Do not use in a place exposed to strong electromagnetism.

Protecting your images

- Select the write-protect switch on the exterior card casing to protect your images. (SDMC)
- Do not power off any devices while transferring data, as this may destroy the data.
- Back up your image data often to a hard disk or other permanent storage media.
- Be aware that formatting will erase all image data stored on the card.

Note:

- **Sharp Corporation cannot be held liable for data that is lost through improper handling of the storage media.**

Cleaning

- Be careful not to allow dirt and finger grime buildup around the card contacts.
- Be careful about static electricity, which can suddenly erase data.
- If you notice dirt or static electricity, clean the card with a soft, dry cloth.

Condensation

- Be careful about condensation forming on the card surface, which can cause malfunction.
- If you notice beads of water on the card, allow it to evaporate and dry naturally.

Battery Pack

This camcorder uses a lithium-ion type battery pack.

Charging

- Charge the battery pack immediately (or a day) before use. The battery pack gradually self-discharges even if stored in a fully charged state.
- Charge the battery pack between 10°C and 30°C.
- Fully charge the battery pack. Use of an insufficiently charged battery pack will shorten actual time of use.
- Refresh (discharging before charging) is unnecessary.

Use

- To conserve battery power, be sure to turn off the camcorder power when not in use.
- Battery consumption may vary depending on the condition of use. Recording with many starts and stops, frequent zooming, and recording in low temperatures will shorten actual recording times.
- Use of a weak battery pack may cause loss of power while operating the camcorder. Use a fully charged battery pack to protect both the battery pack and the unit.
- It is recommended that you have enough battery packs on hand to handle two or three times your estimated recording time. See page 23 for the approximate times of actual recording for the battery packs.

Battery power is consumed even when the camcorder power is turned off. If you are not going to use your camcorder immediately, remove the battery pack (see page 7).

Note:

- Use only SHARP BT-L227 battery packs. These are designed specifically for use with this camcorder.

Storage

- Store the battery pack in a fully discharged state.
- Store the battery pack in a dry, cool place.
- When storing the battery pack, put it in the original protective plastic bag.

Notes:

- Improper handling of the battery pack may present a risk of fire or explosion. Pay close attention to the following:
 - Do not allow metallic objects to come in contact with the terminals. This can cause a short circuit.
 - Do not attempt to disassemble or repair the battery pack.
 - Do not use any battery charging equipment other than that designed for use with these battery packs.
 - Do not place the battery pack under direct sunlight or in excessively hot places (over 60°C) such as the dashboard of cars.
 - Do not expose the battery pack to moisture or water.
 - Do not drop the battery pack or subject it to strong force.
 - Keep the battery pack out of reach of children.
 - Dispose of used battery packs promptly. Do not dispose of them in fire.
- To protect the terminals, put the cover on the battery pack when it is not in use.
- The battery pack will become warm during charging and use. This is not a malfunction.
- The battery pack has a limited service life. If the period of use becomes noticeably shorter with a normal charge, the battery pack is at the end of its service life. Replace it with a new battery pack.
- If the terminals of the battery pack are dirty, wipe the terminals with a soft, dry cloth.

Extending battery pack life

Even when the battery pack is not used, the capacity of the battery pack will naturally deteriorate over time. To limit the deterioration of the capacity, it is recommended to perform the following procedure at least once every six months:

- ① Charge the battery pack until the POWER/CHARGE (RED) indicator turns off.
- ② Attach the battery pack to the camcorder, and set the Power switch to  without inserting a cassette and turn off the power save mode. Allow the battery power to fully discharge by leaving it on the camcorder until the camcorder power automatically turns off.
- ③ Remove the battery pack and store it between 10°C and 20°C.

AC Adapter

- The AC adapter may interfere with reception if used near a radio.
- Prevent flammables, liquids, and metal objects from entering the adapter.
- The adapter is a sealed unit. Do not attempt to open or modify it.
- Do not damage, drop, or subject the adapter to vibration.
- Do not leave the adapter in direct sunlight.
- Avoid using the adapter in humid or extremely hot places.

Replacing the Fluorescent Lamp

This camcorder uses a fluorescent lamp to backlight the LCD monitor. If the monitor becomes dark or difficult to view, the fluorescent lamp may need to be replaced. Contact the nearest SHARP service centre or your dealer for further advice.

Cleaning

- Many plastic parts are used in the camcorder casing. Do not use thinner, benzene or other strong chemical cleaners. These may cause discolouration and damage to the casing.
- Clean the casing with a soft, dry cloth. If the casing is particularly dirty, wipe the casing with a tightly wrung cloth dampened with a diluted, neutral detergent. Then wipe it again with a soft, dry cloth.
- Use a soft cloth to wipe finger marks and other smudges off the LCD screen.
- Use a soft cloth, or compressed air and lens paper designed for photographic lenses to clean the lens.
- Pull out the viewfinder and open the window cleaning cover as shown below so that you can clean up the inside of the viewfinder with a camera blower.

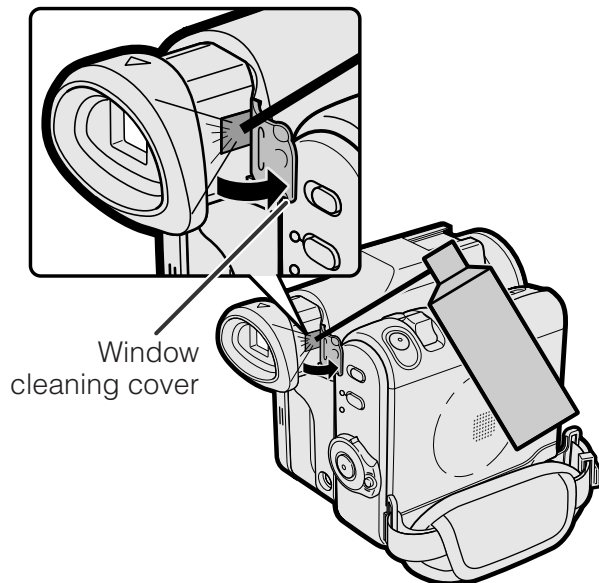

Note:

- After cleaning, close the window cleaning cover securely. Closing the viewfinder with the window cleaning cover opened may cause malfunction.

Appendix

Using Your Camcorder Abroad

Television signal standards and electrical voltages and frequencies vary substantially from country to country. When you are abroad, check the sections below before using the AC adapter or connecting the camcorder to a TV.

AC Adapter (Supplied Accessory)

The supplied AC adapter is compatible with 50 Hz and 60 Hz electrical systems in the range of 110 V to 240 V AC.

Television Signal Standards

In any country, you can always watch the video picture by using the LCD monitor screen. However, if you want to watch the picture on a TV screen, the TV must be PAL system compatible. PAL is used in the following areas:

Germany, United Kingdom, Ireland, Sweden, Denmark, Austria, Belgium, Switzerland, Italy, Spain, Holland, Finland, Portugal, Norway, Hong Kong, Thailand, Australia, New Zealand, Singapore, Kuwait, China, etc.

Troubleshooting

Before calling for service, please check the following troubleshooting table.

	Symptom	Possible cause	Suggested solution
Power	No power.	Power source is not properly connected.	Connect power source properly (pp. 6, 9).
		Battery pack is not charged.	Charge battery pack sufficiently (p. 8).
		Dew in camcorder.	Wait until dew dries (p. vii).
		Safety function is in effect.	Set the Power switch to OFF and remove battery pack. Wait for 2 seconds, then reinstall battery pack and turn on power (pp. 6, 7).
Camera mode	The Record Start/ Stop button does not work.	Erasure-protect tab on video cassette is open.	Close tab or use a new cassette (p. 98).
	Power suddenly turns off.	POWER SAVE menu item is set to "5 MIN" or "10 MIN".	Set the POWER SAVE menu item to "OFF" (p. 43).
	Auto focus does not work.	Manual Focus mode is engaged.	Set to Auto Focus mode (p. 58).
		Zoom used on close subject.	Zoom out from subject (p. 24).
		Subject has little contrast in brightness, or is full of horizontal or vertical stripes.	Focus manually (p. 57).
	Bright subject produces wide vertical lines.	Occurs when shooting subject with strong contrast to the background. Does not indicate a malfunction.	—
Display automatically changes in Camera mode.	Camcorder is in Demo mode.	Set the DEMO MODE menu item to "OFF" (p. 96).	

Appendix

	Symptom	Possible cause	Suggested solution
Playback mode	No image appears on connected TV screen.	Video input channel on TV or TV channel is not selected properly.	Select video input channel or TV channel properly (p. 31).
		Audio/video/S-video cable is not properly connected.	Connect audio/video/S-video cable properly (p. 31).
	Cannot rewind or fast forward tape.	Position at beginning or end of tape.	Rewind or fast forward tape to desired point (p. 29).
		Using a cleaning tape	The cleaning tape will automatically rewind after cleaning finishes (p. viii).
	Video noise in image.	Dirty video heads.	Call for service or use a commercially available cleaning tape (p. viii).
		Old or worn tape.	Use a new cassette.
	No sound.	Using a 12-bit recording tape with AUDIO menu item set to "AUDIO 2".	Set the AUDIO menu item to "AUDIO 1" or "AUDIO 1 + 2" (p. 70).
	Tape does not work.	Power switch is set to Camera mode.	Set the Power switch to Playback mode (p. 22).
		Media Selection switch is set to Card mode.	Set the Media Selection switch to Tape mode (p. 22).
		Battery pack is depleted.	Charge battery pack or replace it with a fully charged one (pp. 6–8).
	Still images in Card mode are rotated 180° upside down.	The images are recorded in self recording with reversed grip.	Transfer the data to PC (pp. 87–92), and rotate the images 180° back by using a commercially available editing software.
	Motion images are rotated 180° upside down.	Improper self recording.	Turn on Rotate Playback (p. 54).

	Symptom	Possible cause	Suggested solution
Card mode	Cannot delete image on card.	Image is delete-protected.	Cancel the protection setting (p. 81).
	Cannot format card.	—	Contact your dealer for advice.
General	Battery pack is easily depleted.	Using camcorder in extremely cold environment.	Warm up battery pack, for example in your pocket, just before using it.
		Battery pack is not fully charged.	Charge battery pack sufficiently (p. 8).
	Clock has been re-set.	Lithium battery is not properly installed.	Install lithium battery properly (p. 12).
		Lithium battery is depleted.	Replace new lithium battery (p. 12).
	Cassette will not eject.	Power source is not properly connected.	Connect power source properly (pp. 6, 9).
		Battery pack is not charged.	Charge battery pack sufficiently (p. 8).
		Camcorder is recording.	Stop recording and try again (p. 24).
	No image on monitor.	Backlight has been turned off.	Turn on backlight (p. 25).
		Fluorescent lamp has burned out.	Call for service.
	Viewfinder picture is hard to see.	Viewfinder dioptre is not properly adjusted.	Adjust dioptre (p. 19).
		Inappropriate picture adjustments.	Adjust picture (p. 94).
	Monitor picture is hard to see.	Inappropriate picture adjustments.	Adjust picture (p. 94).
	POWER/CHARGE (RED) indicator flashes in red when charging battery pack.	AC adapter or battery pack may have malfunctioned.	Call for service.
Cannot edit to connected VCR.	Audio/video/S-video cable is not properly connected.	Connect audio/video/S-video cable properly (p. 71).	

Appendix

	Symptom	Possible cause	Suggested solution
General	Remote control does not function.	REMOTE menu item is set to "OFF".	Set REMOTE menu item to "ON" (p. 50).
		Remote control battery has run down.	Replace remote control battery with new one (p. 13).
		Remote control used beyond operating range.	Use remote control within operating range (p. 50).
		Intense daylight falling on camcorder remote sensor.	Protect remote sensor from exposure to intense daylight (p. 50).
	Obstacle between remote control and camcorder remote sensor.	Remove obstacle or use remote control from different angle (p. 50).	
	"E007" is displayed on the screen, and unable to operate normally.	The camcorder may be damaged.	Do not take out a cassette, and call for service.

Notes:

- This unit is equipped with a microprocessor. Its performance could be adversely affected by external electrical noise or interference. If this should happen, turn off the power and disconnect the unit from any power sources, including the lithium battery, etc. Then reconnect the power sources to resume operation.
- If the characters displayed in the viewfinder or on the LCD monitor screen appear to malfunction, disconnect the power source and remove the lithium battery, then reconnect the power source, insert the lithium battery, and turn the power on again. The characters on the monitor should be normal. Set the date and time, then resume operation.



Specifications

Camcorder

Signal System:	PAL standard
Recording System:	2 rotary heads, helical scanning system
Cassette:	Digital VCR Mini DV video cassette
Recording/Playback Time:	90 minutes (DVM60, LP mode)
Tape Speed:	SP mode: 18.831 mm/second LP mode: 12.568 mm/second
Pickup Device:	1/4" (6.4 mm, effective size: 4.5 mm) CCD image sensor (with approx. 1,330,000 pixels including optical black, effective pixels: 690,000 pixels in Tape Camera mode, 1,250,000 pixels in Card Camera mode)
Lens:	10× optical zoom lens (F1.8, f=3.8–38.0 mm)
Lens Filter Diameter:	30 mm
Monitor:	2.5" (6.4 cm) CGSilicon
Viewfinder:	0.16" LCD panel (with 113,578 pixels), slide type
Built-in microphone:	Electret stereo microphone
Colour Temperature Compensation:	Auto white balance with white balance lock, outdoor or indoor
Minimum Illumination:	3 lux* (with gain-up, F1.8)
Still Image Compression System:	JPEG base line conformance
Still Image Recording Format:	JPEG (Exif2.2)
USB terminal:	Mini-B type connector (USB 1.1 version)
DV terminal:	4 pin connector (i.LINK)
Still Image Recording Medium:	SD Memory Card, MultiMediaCard
Power Requirement:	DC 7.4 V
Power Consumption:	3.8 W (during camera recording in Tape Camera mode using the viewfinder in Full Auto mode with the DIS function on) 4.3 W (during camera recording in Tape Camera mode using the LCD monitor in Full Auto mode with the DIS function on and backlight in normal mode)
Operating Temperature:	0°C to +40°C
Operating Humidity:	30% to 80%
Storage Temperature:	–20°C to +60°C
Dimensions (W×H×D) (approx.):	82.9 mm × 86.2 mm × 100.8 mm
Weight (approx.):	495 g (without battery pack, lithium battery, video cassette, lens cap and card)

AC Adapter (UADP-A053WJZZ)

Power Requirement:	AC 110–240 V, 50/60 Hz
DC Output:	10 V
Dimensions (W×H×D) (approx.):	49.0 mm × 27.5 mm × 79.0 mm

Specifications are subject to change without notice.

*Minimum illumination: Since there is no widely accepted testing procedure for determining minimum illumination capability, lux ratings are comparable only between models from the same manufacturer.

On-screen Display Index

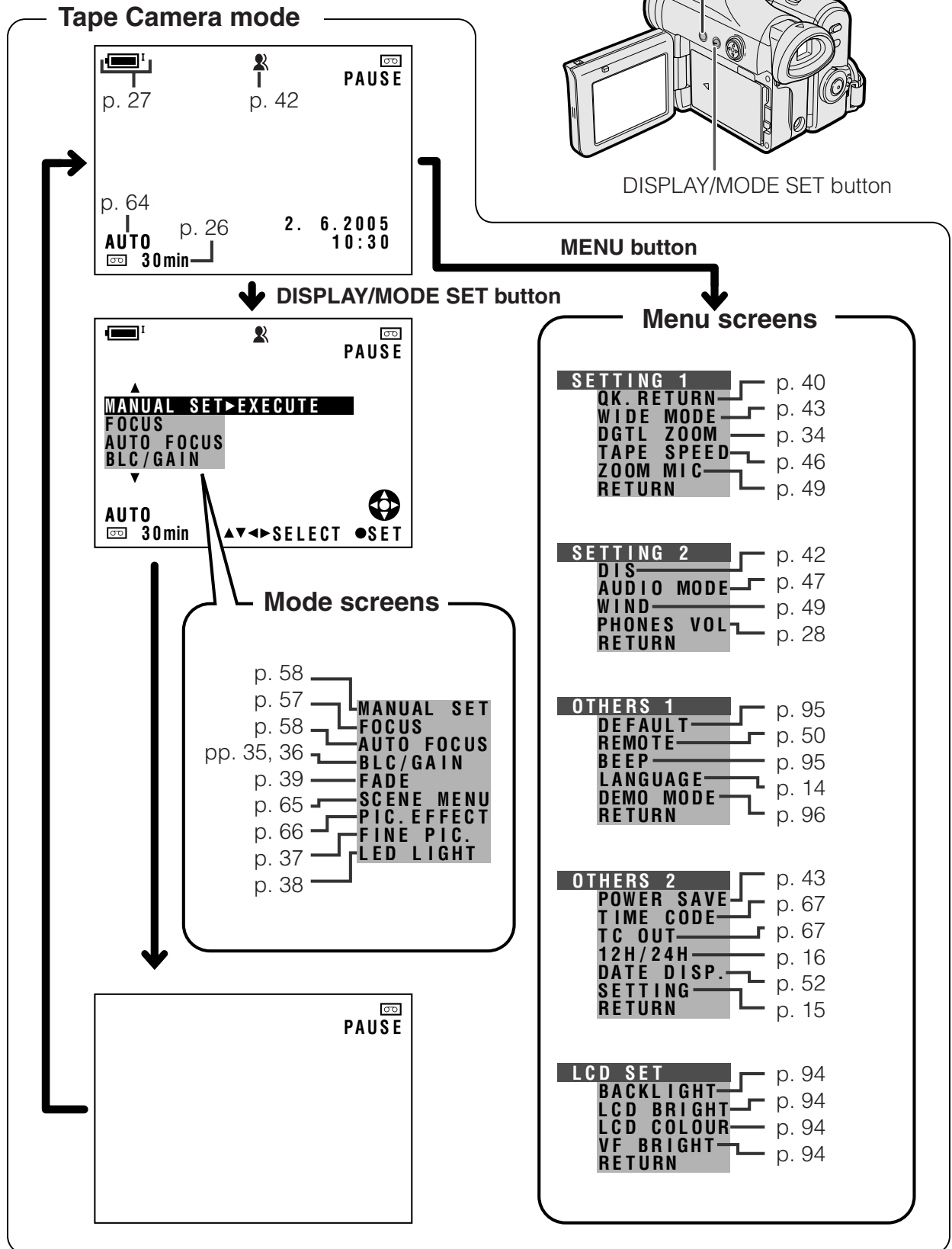

Tape Playback mode

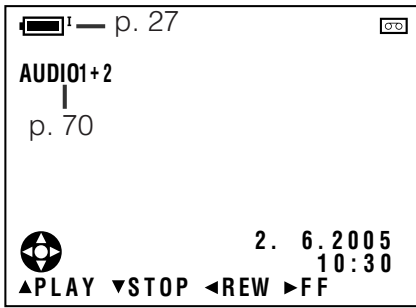

MENU button

Menu screens

PLAYBACK SET
 ROTATE PB — p. 54
 AUDIO — p. 70
 RETURN

OTHERS 1
 DEFAULT — p. 95
 REMOTE — p. 50
 BEEP — p. 95
 LANGUAGE — p. 14
 RETURN

OTHERS 2
 POWER SAVE — p. 43
 TIME CODE — p. 67
 TC OUT — p. 67
 12H/24H — p. 16
 DATE DISP. — p. 52
 SETTING — p. 15
 RETURN

LCD SET
 BACKLIGHT — p. 94
 LCD BRIGHT — p. 94
 LCD COLOUR — p. 94
 VF BRIGHT — p. 94
 RETURN

DISPLAY/MODE SET button

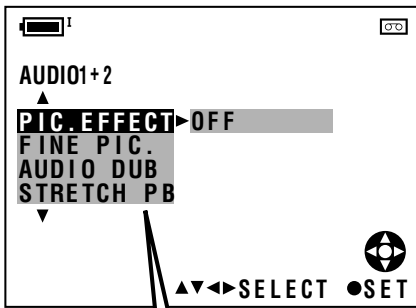

Mode screens

p. 53 — PIC.EFFECT
 p. 54 — FINE PIC.
 p. 69 — AUDIO DUB
 p. 56 — STRETCH PB

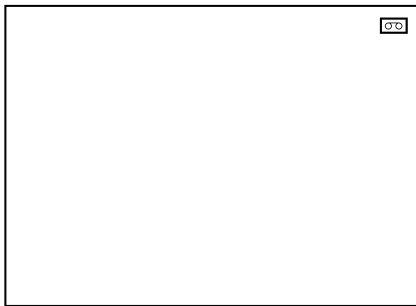

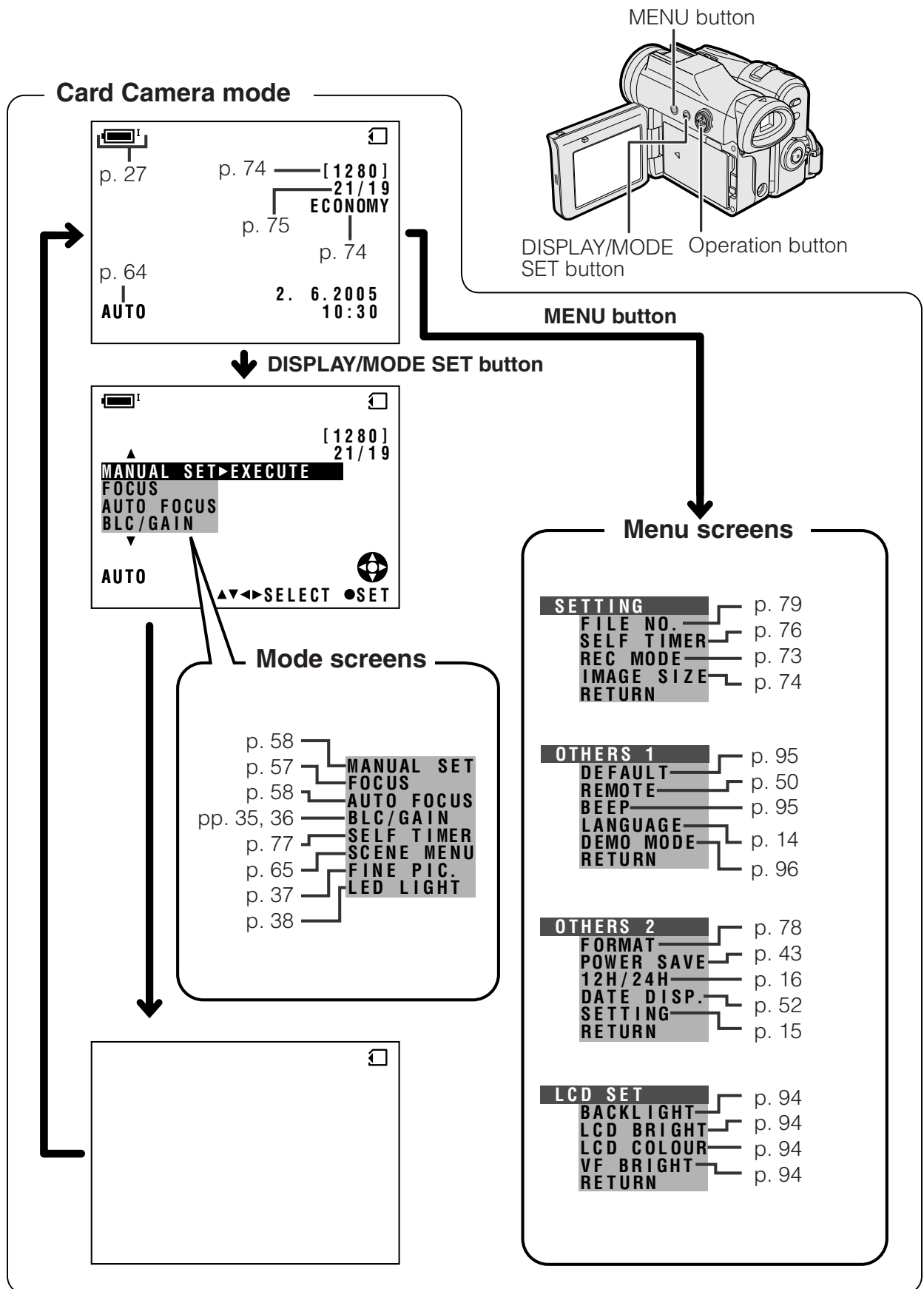

Card Playback mode

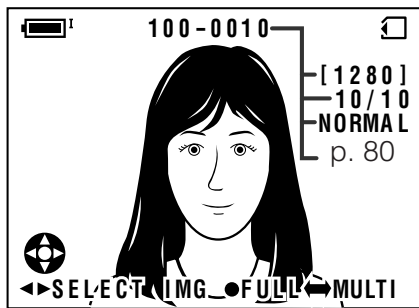

Operation button

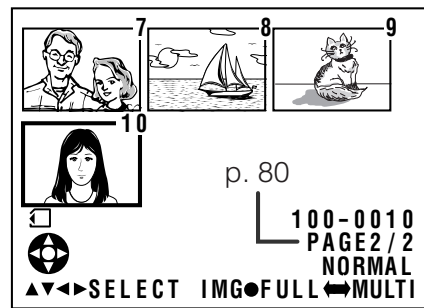

DISPLAY/MODE SET button

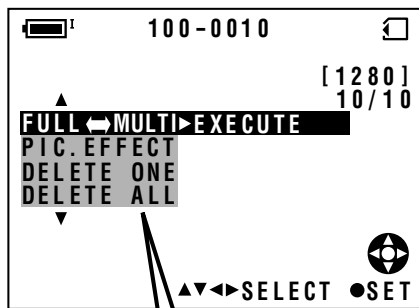

MENU button

Menu screens

PLAYBACK SET

- SLIDE SHOW — p. 93
- PRI. ORDER — pp. 84, 85
- SQUEEZE PB — p. 92
- RETURN

OTHERS 1

- DEFAULT — p. 50
- REMOTE — p. 95
- BEEP — p. 95
- LANGUAGE — p. 14
- RETURN

OTHERS 2

- FORMAT — p. 78
- POWER SAVE — p. 43
- 12H/24H — p. 16
- DATE DISP. — p. 52
- SETTING — p. 15
- RETURN

LCD SET

- BACKLIGHT — p. 94
- LCD BRIGHT — p. 94
- LCD COLOUR — p. 94
- VF BRIGHT — p. 94
- RETURN

Mode screens

- p. 80 — FULL MULTI
- p. 53 — PIC. EFFECT
- p. 82 — DELETE ONE
- p. 83 — DELETE ALL
- p. 86 — DIRECT PRI
- p. 81 — PROTECT

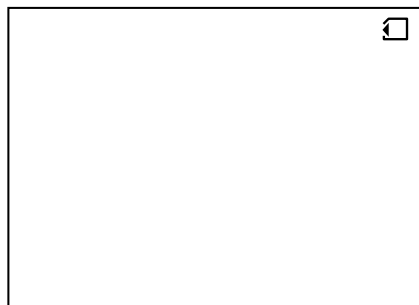

Index

A

AC adapter	8, 9
Audio dubbing	68, 69
Audio playback mode	70
Audio recording mode	47
Auto focus	26
AV terminal	31, 71

B

Backlight	25, 94
Backlight compensation (BLC)	35
Battery release	7, 12
Battery pack	6, 7, 100, 101
Beep	95

C

Card	11
Card playback	80
Card slot cover	11
Charging	8
Conversion lens	18

D

Date and time	52
Default	95
Delete	82, 83
Demo mode	96
Digital zoom	34
Dioptr adjustment dial	19
Direct Print	86
DIS	42
DISPLAY/MODE SET button	32
DPOF	84
DV terminal	72

E

Earphones jack	28
Edit search	41
Erasure protect tab	98

F

Fade	39
Fine picture	37
Fine picture playback	54
Format	78
Frame advance	51
Full Auto	64
Full screen	80

G

Gain	62
Gain-up	36

H

Hand grip	17
Hand strap	17

I

Image size	74
Information display	32
Iris	61

L

LCD bright	94
LCD colour	94
LCD LAMP button	25
LCD monitor	20
LED video light	38
Lens cap	16
Lithium battery	12, 13
LP mode	46

M

Manual focus	57
Manual setting	58
Media Selection switch	22
MENU button	33
Menu screen	33
Mini DV cassette	10, 97, 98
Mode screen	32
MultiMediaCard	99

O

Operation button	32
------------------------	----

P

Part names	1-3
Phones volume	28
PHOTO button	41, 55, 75
Photo copy	55
Picture effect	66
Picture effect playback	53
Picture quality	73
PixLab Media Browser	87-91
POWER CHARGE (RED) indicator ...	8, 9, 23
Power save mode	43
Power standby mode	25
Power switch	22
Power Zoom control	24
PRINT Image Matching II	86
Print indicator	84, 85
Protect	81

Q

Quick Return	40
--------------------	----

R

Record Start/Stop button	23
Recording Standby mode	23, 24
Recording time	23
Remote control	50
Reverse playback	51
Rotate playback	54

S

Scene menu	65
SD Memory Card	99
Self recording	44, 45
Self timer	76, 77
Shutter speed	63, 64
Slide show playback	93
Slow	51
SP mode	46
Squeeze playback	92
STANDBY button	25
Still recording	41
Stretch playback	56

T

Tape playback	29
Tape speed	46
Terminal cover	2
Thumbnail screen	80
Time Code	67

U

USB terminal	89
--------------------	----

V

VF bright	94
Video search	30
Viewfinder	18, 19
Volume control	30

W

Warning indicator	4, 5
White balance	59, 60
Wide mode	43
Windbreak	49
Window cleaning cover	101
Write-protect switch	11

Z

Zoom	24
Zoom microphone	48

