



---

**INSTALLATION/OPERATION MANUAL**

---

***LightStyle***<sup>TM</sup>

**LS-10i**

**DLP<sup>TM</sup> Home Theater Projector**



**THE WORLD'S FINEST HOME THEATER PRODUCTS<sup>TM</sup>**



---

# RuncoCare™ Standard Two Year Limited Warranty

Congratulations on your purchase of a Runco® product! With proper installation, setup and care, you should enjoy many years of unparalleled video performance.

This RuncoCare Standard Limited Warranty is provided free of charge by Runco International, LLC (“Runco”) with the purchase of a covered Runco product. The following sets forth Runco’s Standard Limited Warranty applicable to all Runco projectors, processors, LCD display and plasma display products, with the exception of the following models: XP-103DHD, SC-1, SC-1a, CW-95DHD and VW-100HD<sup>1</sup>.

The following terms and conditions of the RuncoCare Standard Limited Warranty represent a contract between us, Runco, and you, the customer, who has purchased a Runco product. This contract applies to purchases of covered Runco products occurring on or after **February 11, 2010**. Runco reserves the right to change the terms of this contract, and such changes shall apply to purchases of covered Runco products that occur on or after any future effective date.

## RuncoCare Standard Features

- Two-year protection from defects in material and workmanship
- Access to 24x7 phone support
- Complimentary, second-day one-way shipping

## Warranty Coverage

Runco warrants its products to be free from defects in material and workmanship during the warranty period provided below. If, in Runco’s sole determination, a product proves to be defective in material or workmanship during the warranty period, Runco will repair the product, replace the product with a substantially similar new or like-new product, or refund a prorata share of the purchase price (calculated based on the remainder of the warranty period and the then-current MSRP<sup>2</sup> of a similar product), if repair or replacement of the product is determined by Runco to not be feasible. Runco has sole discretion in determining whether a same or like model is offered, and what constitutes a “substantially similar model.”

## Length of Warranty

Runco products are warranted for two (2) years from the date of shipment from Runco. Lamps are warranted six (6) months from the date of shipment or 1000 hours of use, whichever comes first. All other accessories, which include but are not limited to, cables, remotes, carrying cases, lens cap and other peripherals sold with the Runco product, are warranted for ninety (90) days from the date of the original shipment of the accessory.

## Eligibility

This RuncoCare Standard Limited Warranty is valid only for the first customer who purchases the covered product from an authorized Runco dealer or distributor. This warranty is not transferable. You may be required to provide proof of purchase in order to receive warranty services.

- 
1. Runco may update this list of products excluded from this warranty from time to time at Runco’s sole discretion, but updates to the list of covered products will not apply on a retroactive basis.
  2. MSRP is defined as the most recent product price listed on Runco’s price list.

---

## **RuncoCare Claim Procedure**

In the event of a product defect, please follow the warranty claim procedure provided below:

1. The Customer is required to contact a Runco dealer or Runco Technical Support via email at support@runco.com or via phone at (toll free) (800) 23RUNCO (800-237-8626). If the customer is located outside North America, call +3589 4200 554 in Europe for product service.
2. Be prepared to provide the date of purchase, the place of purchase, serial number, product model number, description of the problem and troubleshooting steps already attempted.
3. Runco Technical Support staff will attempt to correct any minor issues that may be causing the problem. If Runco is unable to resolve the problem through troubleshooting, a Return Material Authorization (RMA) number will be issued for the exchange of the defective product if it is determined that the claim was made within the coverage period of the Standard Limited Warranty.
4. If it is determined that the Standard Limited Warranty applies to the claim, the customer will need to return the defective product to the Runco repair depot location specified by the Runco technical support representative. The customer will need to properly package the defective product, consisting of the product only, and not include any accessories (e.g., cables, remotes, carrying cases, lens, lens cap and other peripherals) and return it to the Runco repair depot specified by the technical support representative. It is the customer's responsibility to properly package the hardware, include all appropriate materials, and return it to the location specified by the Runco technical support department. The customer will need to address and resolve any shipping damage claims directly with the shipping company.
5. The customer is responsible for providing a suitable box to ship the defective product to an authorized Runco repair depot. Boxes may be purchased from a Runco technical support representative.
6. The customer is responsible for paying freight charges to ship the defective product to an authorized Runco repair depot.
7. For in-warranty repairs, Runco will pay freight charges to return the repaired/replacement product (which shall not include accessories--e.g., cables, remotes, carrying cases, lens cap and other peripherals sold with the Runco product) to the customer from the Runco repair depot.
8. Once an RMA has been created, the customer may contact serviceorders@runco.com for followup questions or confirmation status of the claim process.

## **Warranty Exclusions**

This RuncoCare Standard Limited Warranty does not include or is limited by the following:

1. Products not purchased from an authorized Runco dealer
2. Rental costs incurred by the customer in the event of product defect or failure
3. Any product with a defaced, modified, or removed serial number
4. Damage, deterioration, or malfunction resulting from:
  - a Accident, abuse, misuse, neglect, improper ventilation, fire, water, disaster, lightning, or other acts of nature, smoke exposure (cigarette or otherwise), unauthorized product modification (including use of an unauthorized mount), or failure to follow instructions supplied with the product
  - b Repair or attempted repair by anyone not authorized by Runco
  - c Any damage to the product due to shipment
  - d Removal or installation of the product
  - e Causes external to the product, such as electric power fluctuations or failure
  - f Use of supplies or parts (including lamps) that are not purchased from Runco or do not meet Runco's specifications
  - g Normal wear and tear



- 
- h Expected lamp degradation and normal decrease in lamp output over a period of time or as the lamp is consumed
  - i Customer caused defects, including but not limited to, scratched/defaced/altered plastics
  - j Failure to follow maintenance procedures as outlined in the product's user guide where a schedule is specified for regular cleaning of the product
  - k Opening the product and/or tampering with internal circuitry
  - l Products lost, stolen or discarded
  - m Any damage or dissatisfaction associated with latent images, "burnin," or any other damage determined by Runco to be the result of customer use patterns
  - n Any other cause, which does not relate to a product defect in material or workmanship
5. Removal, installation, and setup service charges are excluded from this Standard Limited warranty
  6. Black uniformity issues or other LCD issues associated with usage outside the Runco recommended guidelines and specifications for the product
  7. Bright or dark sub pixels that are characteristic of LCD technology and considered by Runco to be acceptable and within Runco's manufacturing specifications. (See "Sub Pixel Policy," below.)
  8. Second day shipment delivery time and availability may vary based on origin and destination and Runco is unable to deliver to PO Box and FPO Box addresses

### **Sub Pixel Policy**

It is not uncommon for one or more sub pixels to become bright or dark during or after the manufacturing process. A bright sub pixel is one that remains in the on position, and a dark sub pixel is one that appears black or off. The sub pixels are usually hard to see and will not detract from the display quality or usability at normal viewing distance. The following are Runco's criteria for identifying bright or dark sub pixels that would be considered unacceptable: a) the number of bright or dark sub pixels; b) the location of the bright or dark sub pixels; c) the color of the bright sub pixels; and d) the Runco model size. If sub pixels have been identified as unacceptable by Runco the LCD will be deemed faulty and will be replaced if reported within the warranty period. If there are issues with bright or dark sub pixels, gather the information listed above and call or email [support@runco.com](mailto:support@runco.com).

### **Other Terms and Conditions**

1. Runco will not accept returned Product unless an RMA number has been issued by Runco.
2. If an Advance Exchange return occurs, it is the customer's responsibility to properly package the defective product and ship it to the address provided by the Runco technical support representative with the RMA number prominently displayed. If the defective product is not properly packaged and is damaged in transit during its return to Runco, you may be invoiced for either the repair costs, if repairable, or the MSRP of a replacement product and shipping costs incurred by Runco.
3. The repaired or replaced product will assume the remainder of your original product's RuncoCare Service Plan term or 90 days from the date the repaired unit is shipped, whichever is longer.
4. If a replacement product is sent, the customer agrees to retain the replacement for the product you purchased and your defective product becomes the property of Runco.

### **Extended Service Options**

Runco offers extended and expanded service plans. For information on additional product protection, please email [serviceorders@runco.com](mailto:serviceorders@runco.com) or call (toll free) (800) 23RUNCO (800-237-8626).

---

## **Online Product Registration**

Please visit <http://www.runco.com/support/product-registration/> to register product.

## **Limitation of Implied Warranties**

RUNCO PROVIDES NO WARRANTIES, EXPRESS OR IMPLIED, EXCEPT THOSE EXPRESSLY PROVIDED HEREIN. RUNCO EXPRESSLY DISCLAIMS ALL OTHER WARRANTIES, INCLUDING THE IMPLIED WARRANTIES OF MERCHANTABILITY AND FITNESS FOR A PARTICULAR PURPOSE.

## **Exclusion of Damages**

RUNCO'S MAXIMUM AGGREGATE LIABILITY HEREUNDER IS LIMITED TO THE COST OF REPAIR OR REPLACEMENT OF THE PRODUCT.

1. RUNCO SHALL NOT BE LIABLE FOR DAMAGE TO OTHER PROPERTY CAUSED BY ANY DEFECT IN THE PRODUCT, DAMAGES BASED UPON INCONVENIENCE, LOSS OF USE OF THE PRODUCT, LOSS OF TIME, LOSS OF PROFITS, LOSS OF BUSINESS OPPORTUNITY, LOSS OF GOODWILL, INTERFERENCE WITH BUSINESS RELATIONSHIPS, OR OTHER COMMERCIAL LOSS, EVEN IF THE CUSTOMER HAS BEEN ADVISED OF THE POSSIBILITY OF SUCH DAMAGES.
2. RUNCO SHALL NOT BE LIABLE FOR ANY CONSEQUENTIAL, INCIDENTAL, INDIRECT, SPECIAL, OR PUNITIVE DAMAGES.
3. RUNCO SHALL NOT BE LIABLE FOR ANY CLAIM AGAINST THE CUSTOMER BY ANY OTHER PARTY.

## **Effect of Local Law**

This warranty gives you specific legal rights, and you may have other rights, which vary from locality to locality. Some localities do not allow limitations on implied warranties and/or do not allow the exclusion of incidental or consequential damages, so the above limitations and exclusions may not apply to you.

## **COPYRIGHT AND TRADEMARKS:**

© Copyright 2010 Runco International, LLC ("Runco"). This document contains proprietary information protected by copyright, trademark and other intellectual property laws. All rights are reserved. No part of this manual may be reproduced by any mechanical, electronic or other means, in any form, without prior written permission of Runco.

The trademarks reproduced in this Runco Owner's Manual and used on the Runco Products are either owned by Runco or are licensed by Runco. You may not reproduce or use the trademarks without the prior written consent of Runco.

Runco Products are manufactured under one or more of the following patents: US. Patent 6755540 and Other Patents Pending.

# Important Safety Instructions

Thank you for your purchase of this quality Runco video product! It has been designed to provide you with the quality of video that is expected in a home theater. For the best performance, please read this manual carefully as it is your guide through the menus and operation.

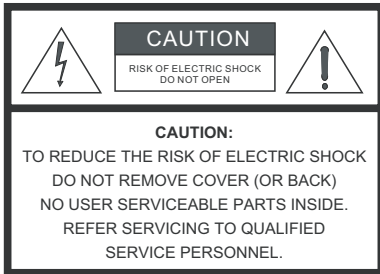

## WARNING

This symbol is intended to alert the user to the presence of uninsulated “dangerous voltage” within the product’s enclosure that may be of sufficient magnitude to constitute a risk of electric shock.



This symbol is intended to alert the user to the presence of important operating and maintenance (servicing) instructions in the literature accompanying the appliance.

1. Read these instructions.
2. Keep these instructions.
3. Heed all warnings.
4. Follow all instructions.
5. Do not use this apparatus near water.
6. Clean only with a dry cloth.
7. Do not block any of the ventilation openings. Install in accordance with the manufacturer’s instructions.
8. Do not install near any heat sources such as radiators, heat registers, stoves, or other apparatus (including amplifiers) that produce heat.
9. Do not defeat the safety purpose of the polarized or grounding type plug. A polarized plug has two blades with one wider than the other. A grounding type plug has two blades and a third grounding prong. The wide blade or the third prong is provided for your safety. When the provided plug does not fit into your outlet, consult an electrician for the replacement of the obsolete outlet.
10. Protect the power cord from being walked on or pinched particularly at plugs, convenience receptacles and the point where they exit from the apparatus.
11. Only use the attachments/accessories specified by the manufacturer.
12. Use only with a cart, stand, tripod, bracket or table specified by the manufacturer or sold with the apparatus. When a cart is used, use caution when moving the cart/apparatus to avoid injury from tip-over.
13. Unplug this apparatus during lightning storms or when unused for long periods of time.
14. Refer all servicing to qualified service personnel. Servicing is required when the apparatus has been damaged in any way, such as power supply cord or plug is damaged, liquid has been spilled or objects have fallen into the apparatus, the apparatus has been exposed to rain or moisture, does not operate normally, or has been dropped.
15. The +12V trigger only outputs 12Vdc signal for triggering. Do not connect to any other power input or output. This could cause damage to this unit.
16. Keep the packing material in case the equipment should ever need to be shipped.
17. The lamp becomes extremely hot during operation. Allow the projector to cool down for approximately 45 minutes prior to removing the lamp assembly for replacement.
18. Do not operate lamps beyond the rated lamp life. Excessive operation of lamps beyond rated life could cause them to explode in rare occasions.



---

19. Never look directly into the lens when the lamp is on.

# Compliance Information

---

## DECLARATION OF CONFORMITY:

Manufacturer's Name: Runco International, LLC

Manufacturer's Address: 1195 NW Compton Drive, Beaverton, OR 97006-1992

hereby declares that the Products' Model Numbers:

LS-10i

conform with the provisions of:

Council Directive 2004/108/EC on Electromagnetic Compatibility;

EN 55022 "Limits and methods of measurements of radio interference characteristics of information technology equipment" 1998;

EN 55024 "Limits and methods of measurements of immunity characteristics of information technology equipment" 1998;

Including:

- EN 61000-4-2 "Electromagnetic compatibility (EMC) Part 4: Testing and measurement techniques Section 2: Electrostatic discharge immunity test"
- EN 61000-4-3 "Electromagnetic compatibility (EMC) Part 4: Testing and measurement techniques Section 3: Radiated, Radio-Frequency, Electromagnetic Field Immunity Test"
- EN 61000-4-4 "Electromagnetic compatibility (EMC) Part 4: Testing and measurement techniques Section 4: Electrical fast transient/burst immunity test"
- EN 61000-4-5 "Electromagnetic compatibility (EMC) Part 4: Testing and measurement techniques Section 5: Surge immunity test"
- EN 61000-4-6 "Electromagnetic compatibility (EMC) Part 4: Testing and measurement techniques Section 6: Conducted disturbances induced by radio-frequency fields immunity test"
- EN 61000-4-8 "Electromagnetic compatibility (EMC) Part 4: Testing and measurement techniques Section 8: Conducted disturbances induced by power frequency magnetic fields immunity test"
- EN 61000-4-11 "Electromagnetic compatibility (EMC) Part 4: Testing and measurement techniques Section 11: Voltage dips, short interruptions and voltage variations immunity tests"

And:

- EN 61000-3-2 "Electromagnetic compatibility (EMC) Part 3, Section 2: Limits for harmonic current emissions (equipment input current up to and including 16 A per phase)" 2000;
- EN 61000-3-3 "Electromagnetic compatibility (EMC) Part 3, Section 3: Limitations of voltage changes, voltage fluctuations and flicker in public low-voltage supply systems, for equipment with rated current up to and including 16 A and not subject to conditional connection" 1995;

Council Directive 2006/95/EC and amended by M1 and C1 on Low Voltage Equipment Safety;

EN 60950 "Safety of information technology equipment, including electrical business equipment"

The Technical Construction file required by this Directive is maintained at the corporate headquarters of Runco International, LLC, located at 1195 NW Compton Drive, Beaverton, OR 97006-1992.

Date of Declaration: September 2010

## FCC PART 15:

NOTE: This equipment has been tested and found to comply with the limits for a Class B digital device, pursuant to Part 15 of the FCC Rules. These limits are designed to provide reasonable protection against harmful interference in a residential installation.

This equipment generates, uses and can radiate radio frequency energy and, if not installed and used in accordance with the instructions, may cause harmful interference to radio communications. However, there is no guarantee that interference will not occur in a particular installation. If this equipment does cause harmful interference to radio or television reception, which can be determined by turning the equipment off and on, the user is encouraged to try to correct the interference by one or more of the following measures:

- Reorient or relocate the receiving antenna.
- Increase the separation between the equipment and receiver.
- Connect the equipment into an outlet on a circuit different from that to which the receiver is connected.
- Consult the dealer or an experienced radio/TV technician for help.

## INDUSTRY CANADA (ICES-003):

This Class B digital apparatus complies with Canadian ICES-003.

Cet appareil numérique de la classe B est conforme à la norme NMB-003 du Canada.

## PRODUCT DISPOSAL:

The Product contains small amounts of tin, lead and/or mercury. Disposal of these materials may be regulated due to environmental considerations.

## IMPORTANT RECYCLE INSTRUCTIONS



Lamp(s) inside this product contain mercury. This product may contain other electronic waste that can be hazardous if not disposed of properly. Recycle or dispose in accordance with local, state, or federal Laws.

For more information, contact the Electronic Industries Alliance at [WWW.EIAE.ORG](http://WWW.EIAE.ORG).

For lamp specific disposal information check [WWW.LAMPRECYCLE.ORG](http://WWW.LAMPRECYCLE.ORG).

## DISPOSAL OF OLD ELECTRICAL AND ELECTRONIC EQUIPMENT (Applicable throughout the European Union and other European countries with separate collection programs)



This symbol found on your product or on its packaging, indicates that this product should not be treated as household waste when you wish to dispose of it. Instead, it should be handed over to an applicable collection point for the recycling of electrical and electronic equipment. By ensuring this product is disposed of correctly, you will help prevent potential negative consequences to the environment and human health, which could otherwise be caused by inappropriate disposal of this product. The recycling of materials will help to conserve natural resources. This symbol is only valid in the European Union. If you wish to discard this product, please contact your local authorities or dealer and ask for the correct method of disposal.

---

**Notes:**

# Table of Contents

<b>RuncoCare™ Standard Two Year Limited Warranty .....</b>	<b>iii</b>
<b>Important Safety Instructions .....</b>	<b>vii</b>
<b>Compliance Information .....</b>	<b>viii</b>
<b>1. Introduction .....</b>	<b>1</b>
About This Manual .....	1
Target Audience .....	1
If You Have Comments About This Manual.....	1
Textual and Graphic Conventions .....	1
Using This Manual .....	2
Description, Features and Benefits .....	3
Key Features and Benefits .....	4
Parts List .....	4
<b>2. Controls and Functions .....</b>	<b>5</b>
LS-10i at a Glance .....	5
LS-10i Rear Panel .....	8
LS-10i Remote Control .....	9
<b>3. Installation .....</b>	<b>13</b>
Remote Control .....	13
Notes on Batteries .....	13
Notes on Remote Control Operation.....	13
Quick Setup .....	15
Installation Considerations .....	16
Installation Type.....	16
Ambient Light .....	17
Throw Distance.....	17
Vertical and Horizontal Position.....	19
Lens Shift .....	19
Folded Optics .....	21
Other Considerations.....	21
Installing the Optional Anamorphic Lens Mount .....	21
Package Contents .....	21

---

Mounting the LS-10i .....	27
Floor Mounting (Upright) .....	27
Ceiling Mounting (Inverted).....	27
Installing the Projector in an Enclosure .....	27
Adjusting the Projection Angle .....	28
Connections to the LS-10i .....	29
Connector Panel Access.....	29
Connecting Source Components to the LS-10i.....	30
RS-232 Controller Connection .....	35
Connecting 12-Volt Trigger Output to External Theater Equipment .....	36
Connecting an External IR Receiver .....	37
Connecting to AC Power .....	37
Turning on the Power .....	38
Primary Lens Adjustments .....	38
Focus .....	38
Zoom.....	38
Lens Shift .....	38
Changing the OSD Language .....	39
Adjusting the Picture Orientation .....	39
Rear Projection .....	39
Ceiling Mode.....	39
Installing and Adjusting the Anamorphic Lens .....	40
Anamorphic Lens Installation and Adjustment .....	40
<b>4. Operation .....</b>	<b>43</b>
Selecting An Input Source .....	43
Selecting An Aspect Ratio .....	43
Selecting Video Memory .....	43
Using Picture-In-Picture (PIP) .....	44
Using the On-Screen Menus .....	45
Main .....	46
Advanced .....	55
System .....	62
Control .....	66
Language .....	67
Service .....	68



---

<b>5. Maintenance and Troubleshooting .....</b>	<b>71</b>
Lamp Replacement .....	71
Troubleshooting Tips .....	72
<b>6. External Control .....</b>	<b>75</b>
Serial Communications .....	75
RS-232 Connection and Port Configuration .....	75
Serial Command Syntax .....	75
RS-232 Error Codes .....	86
Using HDMI CEC Messages .....	87
CEC Command List .....	87
<b>7. Specifications .....</b>	<b>89</b>
LS-10i Specifications .....	89
LS-10i Dimensions .....	92
Supported Timings .....	93

**Notes:**

# List of Figures

---

2-1. LS-10i Front/Side View .....	5
2-2. LS-10i Rear/Bottom/Top View .....	7
2-3. LS-10i Rear Panel .....	8
3-1. IR Reception Angles .....	14
3-2. Estimating Throw Distance .....	17
3-3. Projector Placement .....	19
3-4. Vertical Lens Shift (Example Only) .....	19
3-5. Horizontal Lens Shift (Example Only) .....	20
3-6. Folded Optics .....	21
3-7. Mounting Angle Ranges (Front-to-Back and Side-to-Side) .....	28
3-8. HDMI/DVI Source Connections .....	30
3-9. RGBHV Connections .....	31
3-10. SCART Source Connections .....	32
3-11. Component Video Connections .....	33
3-12. Composite and S-Video Connections .....	34
3-13. RS-232 Control System Connection .....	35
3-14. 12-Volt Trigger Output Connection .....	36
3-15. External IR Receiver Connection .....	37
3-16. Attaching the Anamorphic Lens to the Lens Mount .....	40
4-1. LS-10i OSD Menu Structure .....	45
4-2. LS-10i Main Menu .....	46
4-3. Typical PLUGE Pattern for Adjusting Brightness .....	51
4-4. Typical Gray Bar Pattern for Adjusting Contrast .....	51
4-5. Typical Test Pattern for Adjusting Sharpness .....	52
4-6. Overscan Examples .....	53
4-7. Input Select Sub-Menu .....	54
4-8. LS-10i Advanced Menu .....	55
4-9. RGB Adjust Sub-Menu .....	58
4-10. Fine Sync Sub-Menu .....	59
4-11. PCE Sub-Menu .....	60
4-12. CIE 1931 Chromaticity Diagram .....	61
4-13. LS-10i System Menu .....	62
4-14. Input Enable Sub-Menu .....	63
4-15. PIP and PBP areas for 1080p Display .....	64

4-16. PIP Split-Screen Mode .....	65
4-17. LS-10i Control Menu .....	66
4-18. LS-10i Service Menu .....	68
7-1. LS-10i Dimensions .....	92

# 1. Introduction

This Owner's Manual describes how to install, set up and operate the Runco LS-10i Digital Light Processing (DLP™) Projector.

Throughout this manual, the Runco LightStyle™ Series LS-10i Home Theater Projector is referred to as the "LS-10i."

Runco has prepared this manual to help home theater installers and end users get the most out of the LS-10i.

Runco has made every effort to ensure that this manual is accurate as of the date it was printed. However, because of ongoing product improvements and customer feedback, it may require updating from time to time. You can always find the latest version of this and other Runco product manuals on-line, at [www.Runco.com](http://www.Runco.com).

Runco welcomes your comments about this manual. Send them to [info@Runco.com](mailto:info@Runco.com).

**Text Conventions:** The following conventions are used in this manual, in order to clarify the information and instructions provided:

- Remote and built-in keypad button identifiers are set in upper-case bold type; for example, "Press **EXIT** to return to the previous menu."
- Computer input (commands you type) and output (responses that appear on-screen) is shown in monospace (fixed-width) type; for example: "To change the aspect ratio to Letterbox, type `op aspect = 1 <Enter>`."
- All keys with functional names are initial-capped, set in bold type and enclosed in angle brackets. These keys are the following: **<Enter>**, **<Spacebar>**, **<Control>**, **<Esc>** and **<Tab>**.
- **<Enter>** indicates that you may press either the RETURN or ENTER key on your keyboard if it has both keys.

In addition to these conventions, underlining, boldface and/or italics are occasionally used to highlight important information, as in this example:



## Note

*A carriage return **must** be used after each command or string.*

## 1.1 About This Manual

### ◀ Target Audience

### ◀ If You Have Comments About This Manual...

### ◀ Textual and Graphic Conventions

**Graphic Conventions:** These symbols appear in numerous places throughout the manual, to emphasize points that you must keep in mind to avoid problems with your equipment or injury:



**Tip**

*TIPS highlight time-saving short cuts and helpful guidelines for using certain features.*



**Note**

*NOTES emphasize text with unusual importance or special significance. They also provide supplemental information.*



**Caution**

*CAUTIONS alert users that a given action or omitted action can degrade performance or cause a malfunction.*



**WARNING**

*WARNINGS appear when a given action or omitted action can result in damage to the equipment, or possible non-fatal injury to the user.*



**DANGER!**

*DANGER appears when a given action can cause severe injury or death.*

## 1.2 Using This Manual

Use the following table to locate the specific information you need in this manual.

If you need...	... Turn to page:
Information about obtaining service	iv
General information about the LightStyle™ Series LS-10i Home Theater Projector	3
Installation instructions	13
First-time configuration instructions	38
Advanced configuration instructions	55
Troubleshooting tips	72
Specifications for the LightStyle™ Series LS-10i Home Theater Projector	89

---

The LightStyle™ Series LS-10i Home Theater Projector encompasses Runco's award-winning three-chip performance in an elegant, sleek package. Feature rich, including advanced connectivity and the latest-generation video processing, the LS-10i provides style and elegance to the most exacting custom theaters.

Impressive, unique and unlike single-chip DLP™ implementations, no color wheel is used in the LS-10i. Instead, it harnesses the power of three advanced 16:9 DMD's™ and 12-degree mirror tilt for unsurpassed black level performance. The impressive brightness is further bolstered by the improved contrast capabilities of the stylish LS-10i. This reduces mechanical complexity and compromises to color spectrum purity.

Runco's advanced ViViX™ digital video processing enhances the LS-10i picture quality and provides artifact-free scaling.

The LS-10i features Runco's revolutionary new Personal Color Equalizer™ (PCE), which allows color adjustment that includes those exactly defined by the cinematographer and the color preferences of each individual viewer for each source.

In addition to Runco's proprietary Personal Color Equalizer, the LS-10i can also be paired with Runco's new CineGlide™ lens solution. Through an ingenious combination of software, electronics and precision anamorphic optics, CineGlide provides uncompromised widescreen reproduction of movies originally filmed in the "scope" 2:35:1 format. It maintains constant vertical height on the screen just as in a movie theater. When a viewer transitions from 1.78:1 (16:9) program material to superwide 2.35:1, the image simply gets wider while full screen height is maintained, eliminating useless black bars on the top and bottom of the screen.

**Note**

*CineGlide requires the use of a 2.35:1 or similar aspect ratio superwide format screen.*

Rounding out this projector's impressive feature set are discrete input source, aspect ratio and power on/off, as well as an RS-232 interface for seamless integration with automation control systems.

---

## 1.3 Description, Features and Benefits

- Key Features and Benefits** ➤ The LS-10i offers these key features and benefits:
- Native Resolution: 1920 x 1080 (16:9 Native Aspect Ratio)
  - DLP system using three (3), high-performance Digital Micromirror Device (DMD) chips
  - ConstantContrast™ provides for infinitely variable adjustment of the light path through the optics, enabling the perfect balance of black and white levels for any type of video source material
  - Picture in Picture function allows you to display two inputs on the screen at the same time
  - Two (2), HDMI 1.3 Inputs with High-bandwidth Digital Content Protection (HDCP)
  - HDTV Compatible
  - CinOptx™ *Proteus* lens options for stunning sharpness and throw distance flexibility

**Parts List** ➤ Your LS-10i is shipped with the following items. If any items are missing or damaged, please contact your Runco dealer or Runco Customer Service at (800) 23RUNCO.

- LightStyle™ Series LS-10i Home Theater Projector
- Remote Control Unit and two (2), AAA-size batteries
- AC Power Cords (North America, Europe, United Kingdom)
- Source Connection Cables:
  - Component Video
  - HDMI to HDMI
- Warranty information and registration card
- Cleaning Cloth
- Runco LS-10i Quick Setup Guide

**Optional Accessories:**

- Ceiling mount kit (part number 997-4214-00)
- Replacement Lamp (part number 997-5268-00)



## 2. Controls and Functions

Figure 2-1 and Figure 2-2 show the key LS-10i components.

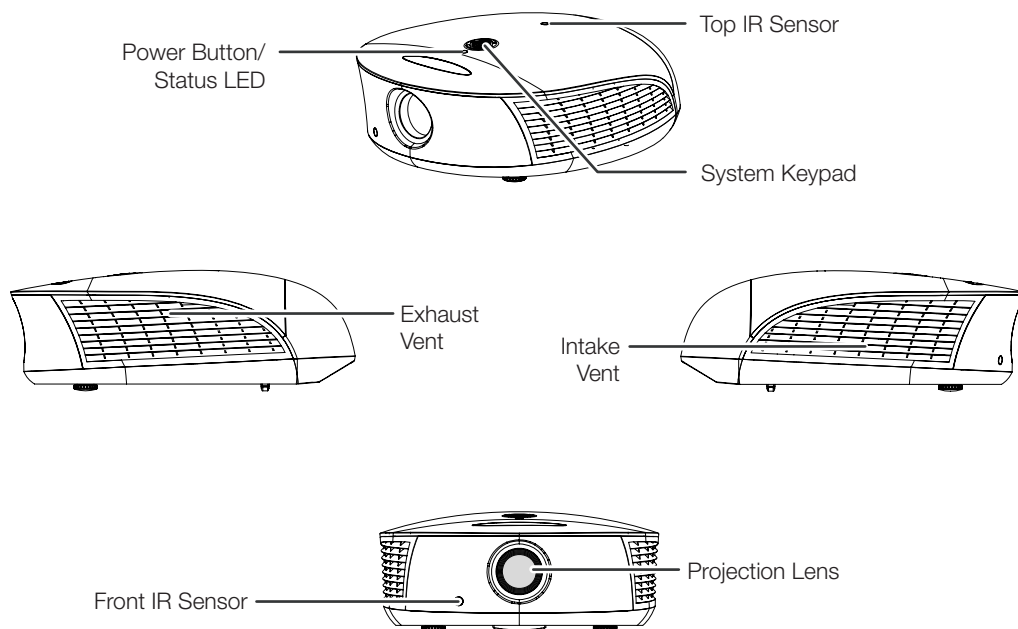

**Figure 2-1. LS-10i Front/Side View**

- **TOP IR SENSOR**

Receives infrared signals from the remote control unit.

- **SYSTEM KEYPAD**

Provides an alternative to using the remote control unit to select a source or navigate the on-screen display (OSD) controls.

**SOURCE**

Use this button to select a video source.

**Cursor Keys (▲, ◀, ▼, ▶)**

Use these buttons to select items or settings, adjust settings or switch display patterns.

**ENTER (↵)**

Press to select a highlighted menu item or confirm a changed setting.

**MENU**

Press this button to show or hide the OSD menus.

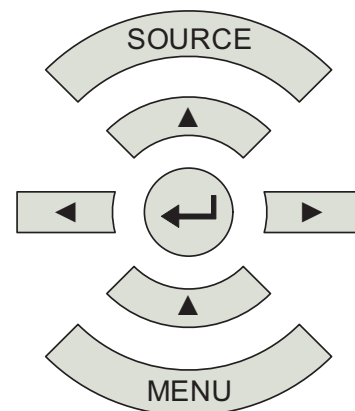

### 2.1 LS-10i at a Glance



- **POWER BUTTON/STATUS LED**

Indicates projector status as follows:

- Solid green = AC power present, ready to turn on (lamp not lit)
- Flashing green = lamp is warming up or cooling down; keypad functions not allowed
- Off = Lamp lit, projector functioning normally
- Alternating green/red = Lamp problem (door open, unable to strike, end of life), user intervention likely to fix problem
- Flashing red = Over temperature, user intervention (clear vents, turn on AC) may fix problem
- Solid red = Error that requires servicing (fan fail, Power-on self-test fail etc.)

- **EXHAUST VENT**

Warm air exits the projector through this vent. Ensure that it is not blocked.

- **INTAKE VENT**

Internal fans draw cool air into the projector through this vent.

- **PROJECTION LENS**

If needed, a light shield accessory is provided with the lens to minimize stray light emissions. (Use it only when the vertical offset is 50% of the screen height or greater.) The light shield attaches to the end of the lens.

- **FRONT IR SENSOR**

Receives infrared signals from the remote control unit.

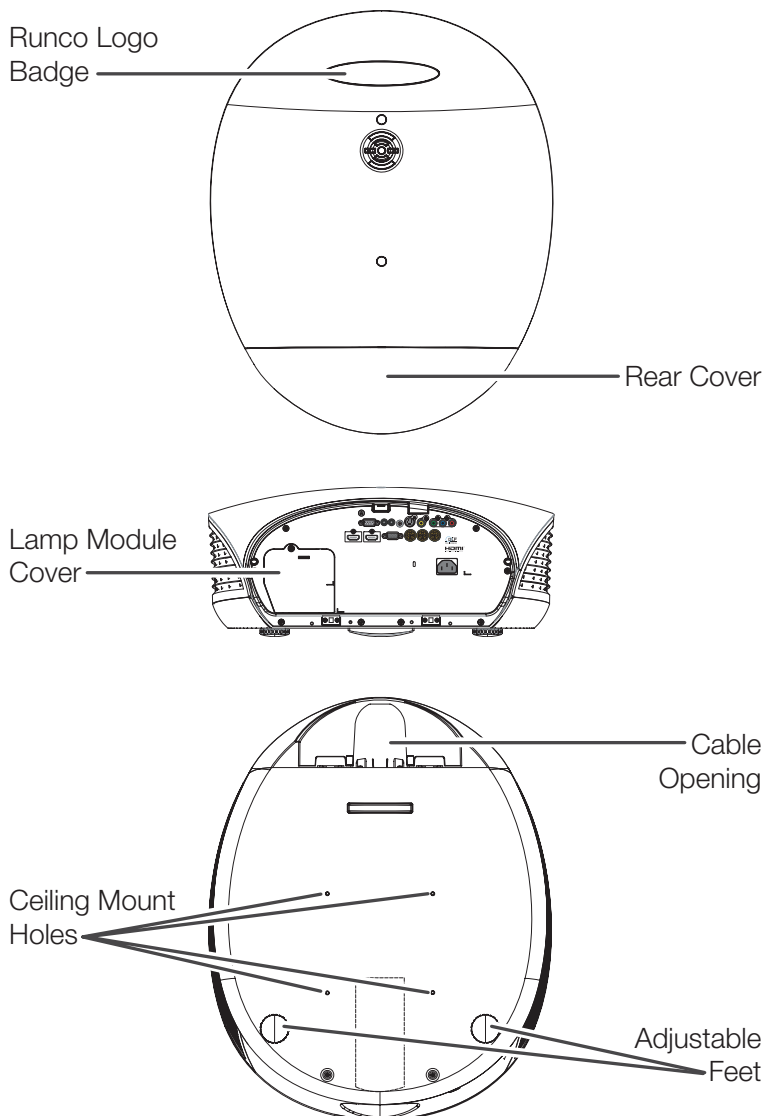
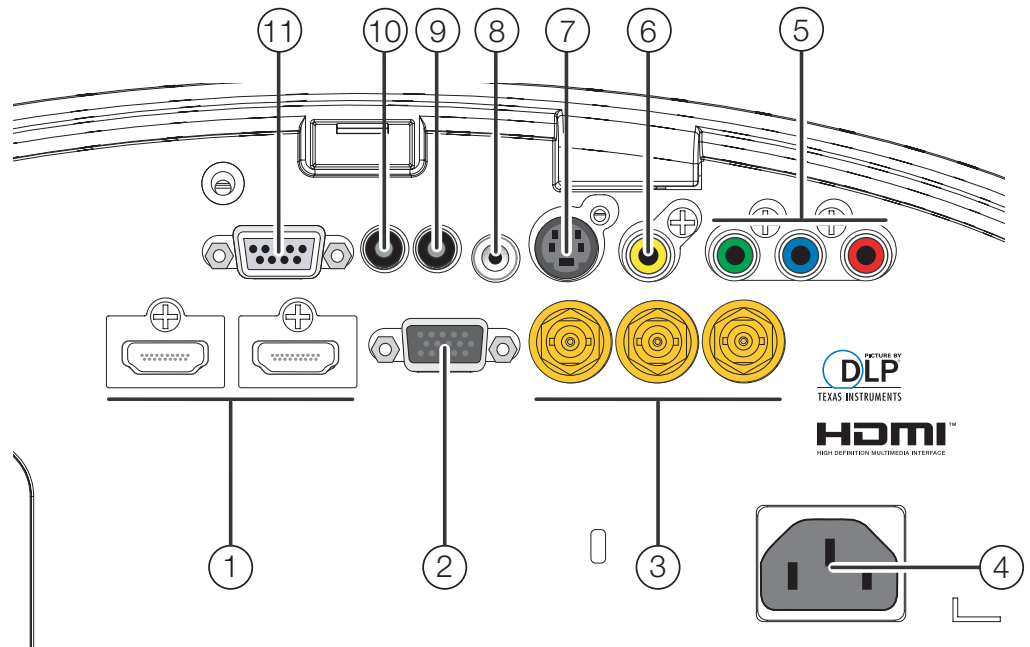

**Figure 2-2. LS-10i Rear/Bottom/Top View**

- **RUNCO LOGO BADGE**
- **REAR COVER**  
Remove to access connectors.
- **LAMP MODULE COVER**  
Remove this cover to access the lamp compartment.
- **CABLE OPENING**  
Pass cables through this opening.
- **CEILING MOUNT HOLES**  
Use these to attach the ceiling bracket to the projector. Use M4 screws with a maximum screw depth of 10 mm (0.39 inch).
- **ADJUSTABLE FEET**  
Use these when the projector is installed in a table-top configuration to level the image and/or adjust the projection angle.

## 2.2 LS-10i Rear Panel

Figure 2-3 shows the LS-10i rear panel.



**Figure 2-3. LS-10i Rear Panel**

1. **HDMI 1 (Digital)  
HDMI 2 (Digital)**  
HDCP-compliant digital video inputs for connecting an HDMI or DVI source.
2. **RGB**  
Provides a standard, 15-pin VGA-style connection to either an RGB or component high-definition source, or to a personal computer. The LS-10i automatically detects the input signal resolution.
3. **COMPONENT 2**  
Three BNCs for connecting component (YPbPr) video sources.
4. **POWER INPUT (100 to 240 VAC)**  
Connect the LS-10i to power here.
5. **COMPONENT 1/SCART (RCA connectors)**  
Standard- or high-definition (480i/480p/576i/576p/720p/1080i/1080p) Component (YPrPb) input for connecting a DVD/HD-DVD/BD player, HD set-top box or other SD/HD source. Also provides RGB input for RGBS sources.
6. **VIDEO**  
Standard composite video input for connecting a VCR, laser disc player or other composite video source. Also provides composite sync input for RGBS sources.
7. **S-VIDEO**  
A standard S-Video input for connecting a DVD player, satellite receiver or Super VHS (S-VHS) VCR.
8. **IR INPUT**  
Wired input from a Nilis- or Xantech-compatible, infrared (IR) repeater system.

9. **TRIGGER 2 (3.5-mm, mini phono jack)**  
Provides 12 (+/- 1.5) volt switched output for an anamorphic lens transport (if installed) or screen relays with 250mA current capacity and short protection.
10. **TRIGGER 1**  
Provides 12 (+/- 1.5) volt switched output for an anamorphic lens transport (if installed) or screen relays with 250mA current capacity and short protection.
11. **RS-232**  
A female, 9-pin D-sub connector for interfacing with a PC or home theater automation/control system.

## 2.3 LS-10i Remote Control

1. **LIGHT**  
Press to illuminate the buttons.
2. **ON / OFF**  
Use these buttons to turn the projector on or off.
3. **Source Selection Buttons:**

### VID

Press to select Composite video input as the source.

### S-VID (S-Video)

Press to select the S-Video input as the source.

### HDMI 1 / HDMI 2

Press to select an HDMI input.

### HD 1 / HD 2 / HD 3

Press to select the "HD 1," "HD 2" or "HD 3" video input as the source. By default, these buttons are assigned to the COMPONENT 1, COMPONENT 2 and RGB video inputs respectively; however, you can re-assign these buttons to other inputs.

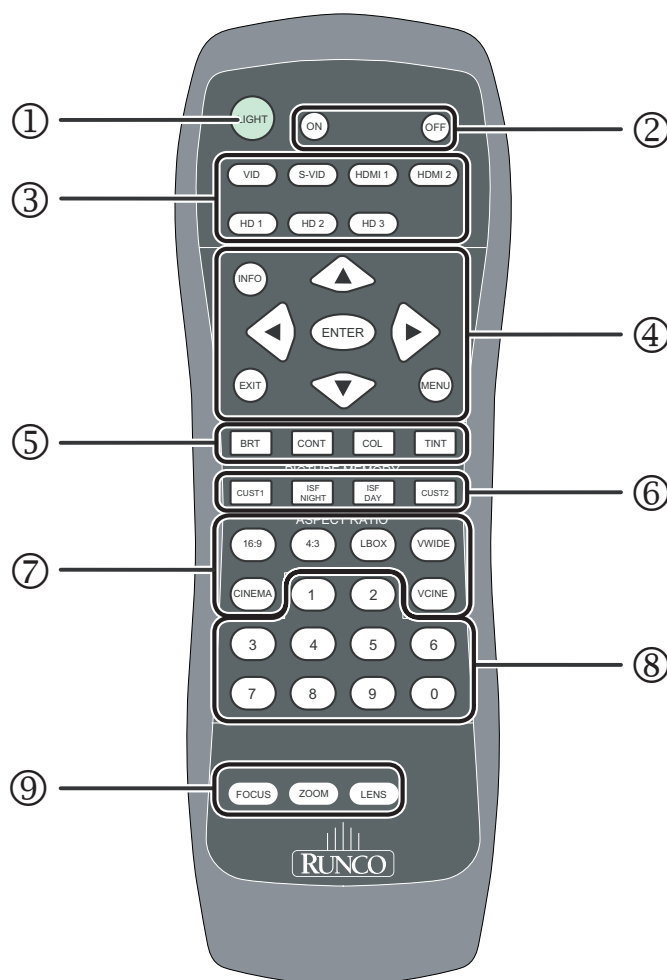

You can also assign these buttons to the Picture-in-Picture (PIP) function. For more information, refer to **HD 1 Key / HD 2 Key / HD 3 Key** on page 66.

4. **INFO**

Press to display input signal and product information.

**Cursor Keys (▲, ◀, ▼, ▶)**

Use these buttons to select items or settings, adjust settings or switch display patterns.

**EXIT**

Press to save menu item setting(s), exit the current menu and return to the previous one.

**ENTER**

Press to select a highlighted menu item or confirm a changed setting.

When Picture-In-Picture (PIP) is active AND no menu or OSD control is present, press **ENTER** to swap the main and PIP sources.

**MENU**

Press this button to show or hide the OSD controls.

5. **Picture Adjustment Buttons:**

**BRT (Brightness)**

Press to adjust black level.

**CONT (Contrast)**

Press to adjust white level.

**COL (Color)**

Press to adjust color intensity.

**TNT (Tint)**

Press to adjust color hues.

6. **Memory Preset Buttons:**

**CUST1**

Press to recall settings for the current input from the "Custom 1" memory preset.

**ISF NIGHT**

Press to recall settings for the current input from the "ISF Night" memory preset.

**ISF DAY**

Press to recall settings for the current input from the "ISF Day" memory preset.

**CUST2**

Press to recall settings for the current input from the "Custom 2" memory preset.

---

## 7. Aspect Ratio Selection Buttons

Use these buttons to select an aspect ratio directly, as follows:

### 16:9

For viewing 16:9 DVDs or HDTV programs in their native aspect ratio.

### 4:3

Scales the input signal to fit 4:3 display mode in the center of the screen.

### LBOX (Letterbox)

For viewing LaserDisc movies or non-anamorphic DVDs on a 16:9 screen.

### VWIDE (VirtualWide)

Enlarges a 4:3 image horizontally in a NON-linear fashion to fit 16:9 full screen display.

### CINEMA

For viewing 2.35:1 source material.

### VCINE (Virtual Cinema)

Selects the Virtual Cinema aspect ratio, used for viewing 16:9 source material on a 2.35:1 screen.

## 8. 0 - 9

Use these keys to enter numeric characters.

## 9. Motorized Lens Controls:

### FOCUS

To focus the image, press **FOCUS**. Then, press and hold the up (▲) or down (▼) button. When finished, press **MENU** or **EXIT**.

### ZOOM

To adjust the projected image size, press **ZOOM**. Then, press and hold the up (▲) button to zoom in (enlarge) or the down (▼) button to zoom out (reduce). When finished, press **MENU** or **EXIT**.

### LENS (Lens Shift)

To adjust the lens position, press **LENS**. Then, press and hold the right (▶), left (◀), up (▲) or down (▼) button. When finished, press **MENU** or **EXIT**.

**Notes:**



## 3. Installation

To install batteries in the remote control:

1. Slide the battery compartment cover in the direction of the arrow to remove it.
2. Install two AAA batteries with the correct polarity.
3. Replace the cover.

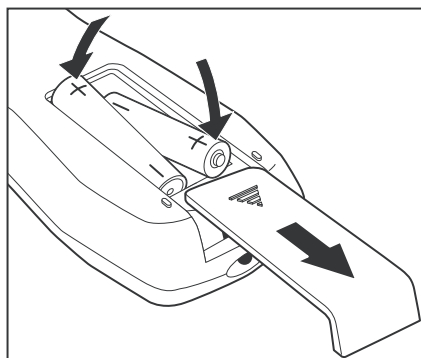

- Make sure that the battery polarities are correct when installing the batteries.
- Do not mix an old battery with a new one or different types of batteries.
- If you will not use the remote control for a long time, remove the batteries to avoid damage from battery leakage.
- In most situations, you can simply point the remote control at the screen which will reflect the IR signal from the remote back toward the IR receiver on the projector. In some cases, however, ambient conditions may prevent this. If so, point the remote control at the projector and try again.
- If the effective range of the remote control decreases, or it stops working, replace the batteries with new ones.
- The remote control may fail to operate if the infrared remote sensor is exposed to bright sunlight or fluorescent lighting.

### 3.1 Remote Control

#### ◀ Notes on Batteries

#### ◀ Notes on Remote Control Operation

- The projector's front IR receiver has a range of approximately 40 feet (12.19 meters); the top IR receiver has a range of approximately 20 feet (6.10 meters). Figure 3-1 shows the reception angles of the front and top IR receivers.

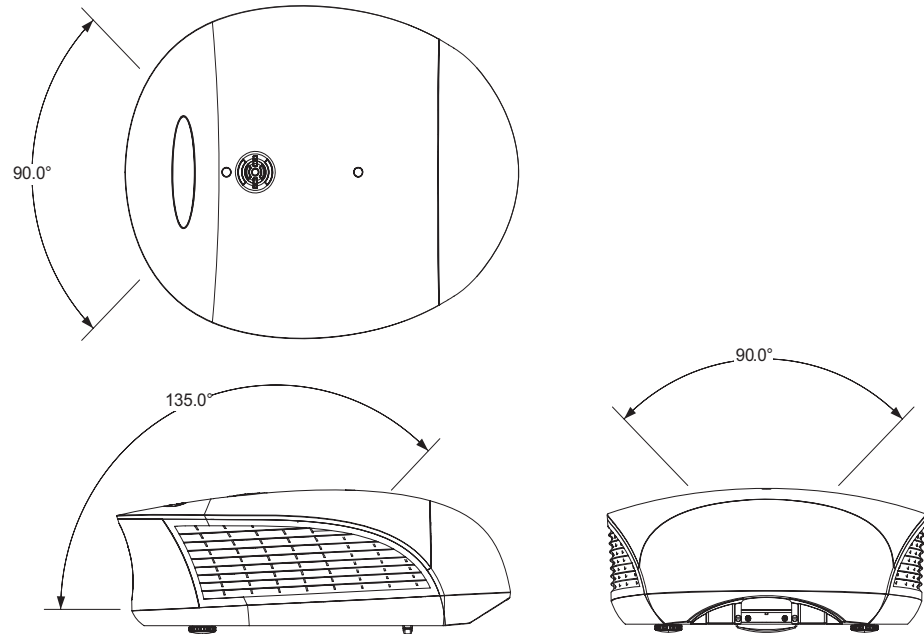

**Figure 3-1. IR Reception Angles**

Table 3-1 gives a quick overview of the LS-10i installation process. The sections following this one provide detailed instructions.

## 3.2 Quick Setup



### Note

*Installation should be performed by a qualified custom video installation specialist.*

**Table 3-1. Installation Overview**

Step	Procedure	For Details, Refer to page...
1	Choose a location for the projector	16
2	Install anamorphic lens mounting assembly (optional)	21
3	Mount the projector	27
4	Connect signal sources to the LS-10i	30
5	Connect external controller to RS-232 port and/or IR repeater system (optional)	35
6	Connect 12-volt trigger output to retractable screen or other, +12V trigger-activated equipment (optional)	36
7	Apply power to the projector	37
8	Primary lens adjustments: projected image size (zoom), position (shift) and focus	19, 38
9	Change the OSD Language (optional)	39
10	For rear-screen and/or ceiling-mount installations, select the proper picture orientation	39
11	Install and adjust secondary anamorphic lens (optional)	40
12	Projector calibration: adjust the following for each input; save settings when finished: <ul style="list-style-type: none"> <li>• Aspect ratio</li> <li>• Brightness</li> <li>• Contrast</li> <li>• Color level</li> <li>• Tint</li> <li>• Sharpness</li> <li>• White Balance</li> </ul>	46

### 3.3 Installation Considerations

Proper installation of your projector will ensure the quality of your display. Whether you are installing a projector temporarily or permanently, you should take the following into account to ensure your projector performs optimally.

**Installation Type** ➤ Choose the installation type that best suits your needs: front or rear screen, floor mount or inverted mount. Table 3-2 compares these various installation methods.

**Table 3-2. Projector Installation Options**

Advantages	Considerations
<b>Front Screen, Floor Mount Installation</b>	
<ul style="list-style-type: none"> <li>• Easy to set up</li> <li>• Can be moved or changed quickly</li> <li>• Easy to access</li> </ul>	<ul style="list-style-type: none"> <li>• Shares floor space with audience</li> </ul>
<b>Front Screen, Inverted Mount (ceiling) Installation</b>	
<ul style="list-style-type: none"> <li>• Does not take up audience space</li> <li>• Projector is unobtrusive</li> <li>• Projector cannot be accidentally moved</li> </ul>	<ul style="list-style-type: none"> <li>• Installation is more permanent</li> <li>• Projector access is more difficult</li> </ul>
<b>Rear Screen, Floor Mount Installation</b>	
<ul style="list-style-type: none"> <li>• Projector is completely hidden</li> <li>• Projector is easily accessed</li> <li>• Usually good ambient light rejection</li> </ul>	<ul style="list-style-type: none"> <li>• Requires separate room</li> <li>• Installation cost is usually higher</li> </ul>
<b>Rear Screen, Inverted Mount (ceiling) Installation</b>	
<ul style="list-style-type: none"> <li>• Projector is completely hidden</li> <li>• Usually good ambient light rejection</li> </ul>	<ul style="list-style-type: none"> <li>• Requires separate room</li> <li>• Installation cost is usually higher</li> </ul>
<b>Rear Screen, Floor Mount with Mirror</b>	
<ul style="list-style-type: none"> <li>• Projector is completely hidden</li> <li>• Usually good ambient light rejection</li> <li>• Requires less space behind screen than other rear screen installations</li> </ul>	<ul style="list-style-type: none"> <li>• Requires separate room</li> <li>• Installation cost is usually higher</li> </ul>

In general, minimize or eliminate light sources directed at the screen. Contrast ratio in your images will be noticeably reduced if light directly strikes the screen, such as when a shaft of light from a window or floodlight falls on the image. Images may then appear washed out and less vibrant.

◀ **Ambient Light**

Throw distance is the distance measured from the front of the projector to the screen. This is an important calculation in any projector installation as it determines whether or not you have enough room to install your projector with a desired screen size and if your image will be the right size for your screen.

◀ **Throw Distance**

You can quickly estimate the throw distance by taking the width of the screen and multiplying it by the lens throw ratio; see Figure 3-2. The result of this calculation tells you roughly how far back the projector should be positioned from the screen in order to project a focused image large enough to fill the screen.

**Estimating Throw Distance**

Throw Distance (TD) =  
Screen Width (w) x Lens Throw Ratio

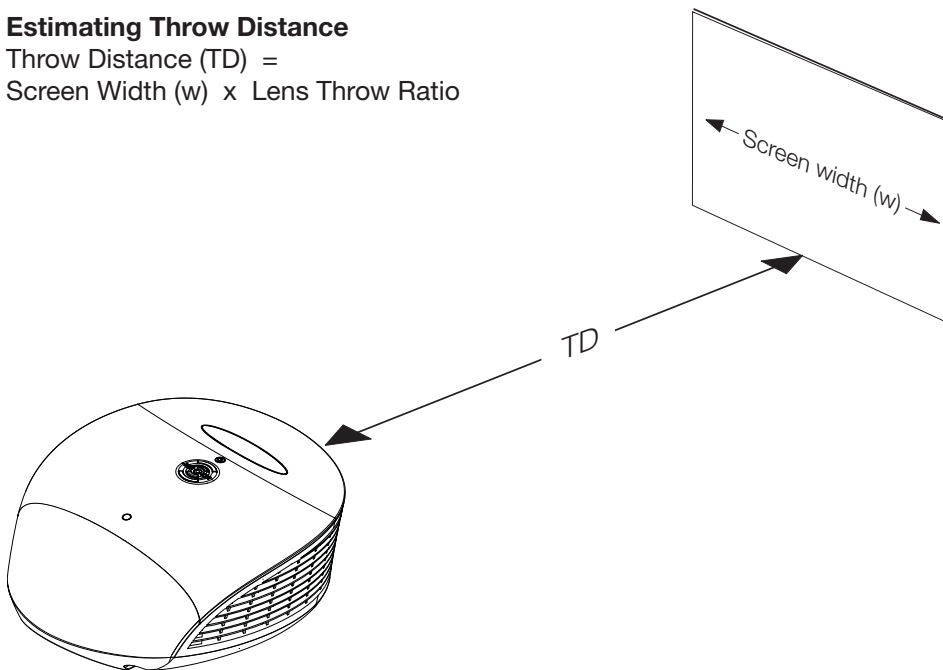

**Figure 3-2. Estimating Throw Distance**

Table 3-3 lists the available LS-10i Series lens options and their associated throw ratios.

**Table 3-3. LS-10i Lens Options and Throw Ratios (Note 1)**

Lens Option	Throw Ratio with Primary Lens Only	Throw Range in inches, with 96x54-inch (1.78:1) Screen		Throw Ratio with Primary Lens and Anamorphic Lens	Throw Range in inches, with 126.9x54-inch (2.35:1) Screen	
		Minimum	Maximum		Minimum	Maximum
Proteus 1	0.77 (Fixed)	For rear-screen installations only. Contact Runco Technical Support for more information.		Not Applicable (Note 2)		
Proteus 2	1.45 - 1.74	139.20	167.04			
Proteus 3	1.74 - 2.17	167.04	208.32	1.30 - 1.63	164.97	206.85
Proteus 4	2.17 - 2.90	208.32	278.40	1.63 - 2.17	206.85	275.37
Proteus 5	2.90 - 4.34	278.40	416.64	2.17 - 3.26	275.37	413.69
Proteus 6	4.34 - 6.76	416.64	648.96	3.26 - 5.07	413.69	643.38

*Notes:*

1. Due to normal manufacturing variances, throw distance can vary by up to +/- 5 percent from these specifications.
2. Only the Proteus 3, 4, 5 and 6 lenses can be used with the optional anamorphic lens. Doing so affects the throw distances as shown here.

Proper placement of the projector relative to the screen will yield a rectangular, perfectly-centered image that completely fills the screen.

◀ **Vertical and Horizontal Position**

Ideally, the projector should be positioned perpendicular to the screen and in such a way that the lens center is aligned with either the top or bottom edge of the screen area, and centered horizontally. See Figure 3-3.

**Ceiling Installation**

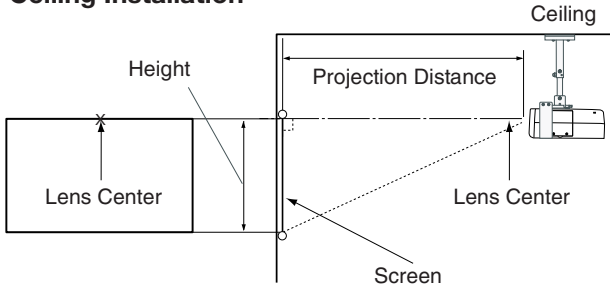

**Floor Installation**

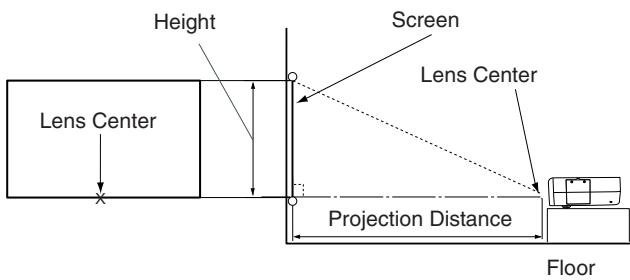

**Figure 3-3. Projector Placement**

You can use the lens shift controls on the projector to center the image on the screen. Lens shift is generally expressed as a percentage of the screen height or width, as shown in Figure 3-4 and Figure 3-5.

◀ **Lens Shift**

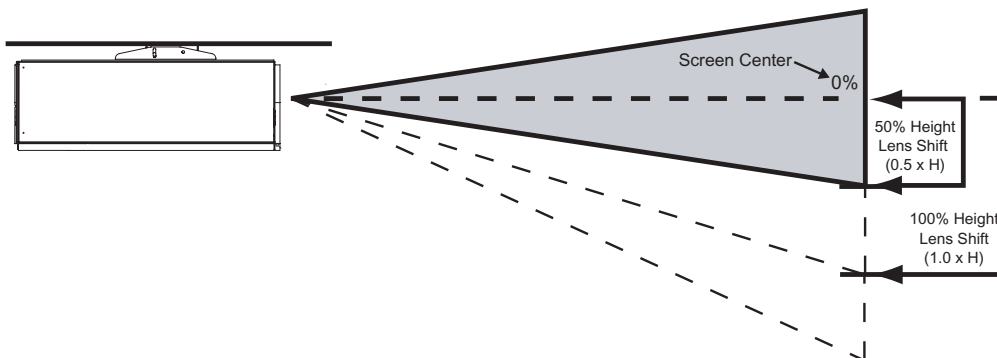

**Note:** This is a general example of lens shift. Lenses vary in their shift capabilities. **No particular lens or projector is used in this example.**

**Figure 3-4. Vertical Lens Shift (Example Only)**

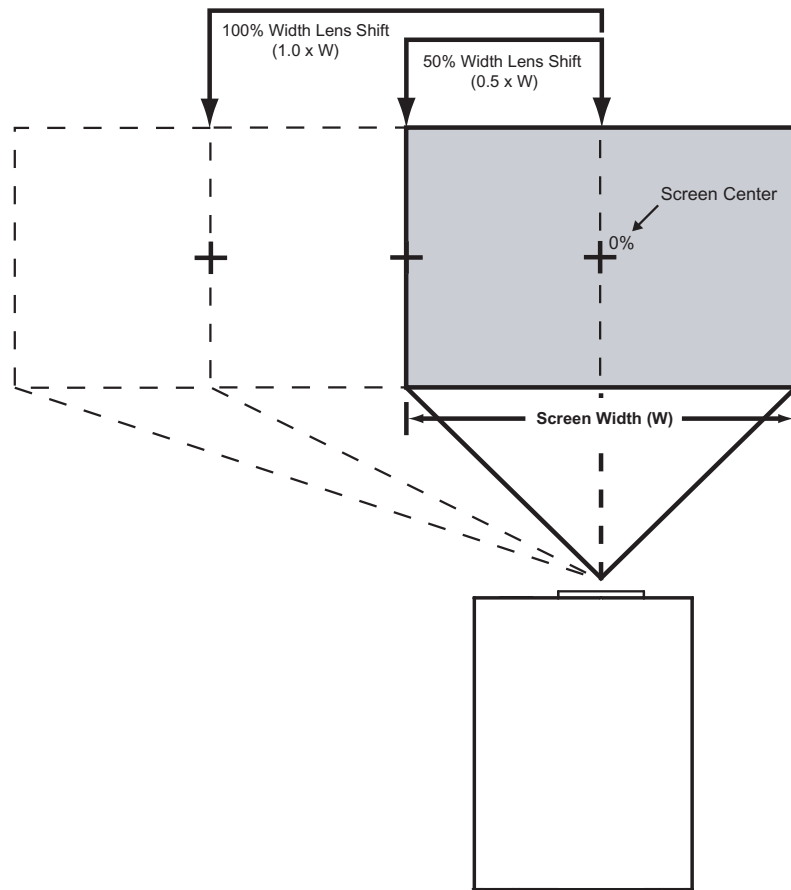

**Note:** This is a general example of lens shift. Lenses vary in their shift capabilities. **No particular lens or projector is used in this example.**

### Figure 3-5. Horizontal Lens Shift (Example Only)

**Vertical Lens Shift:** The LS-10i zoom lenses (Proteus 2 through 6) provide up to 65% of vertical lens shift in either direction (up or down). For example, with a 96 x 54-inch (16:9) screen, you can shift the image up to 35.10 inches (0.89 meters) above or below the screen center. (Vertical lens shift is not possible with the Proteus 1 lens.)

**Horizontal Lens Shift:** The LS-10i zoom lenses (Proteus 2 through 6) allow up to 30% of horizontal lens shift in either direction (left or right). For example, with a 96 x 54-inch (16:9) screen, you can shift the image up to 28.80 inches (73.15 cm) left or right of the screen center. (Horizontal lens shift is not possible with the Proteus 1 lens.)



In rear-screen applications where space behind the projector is limited, a mirror may be used to fold the optical path, as shown in Figure 3-6. The position of the projector and mirror must be accurately set. If you are considering this type of installation, contact your dealer for assistance.

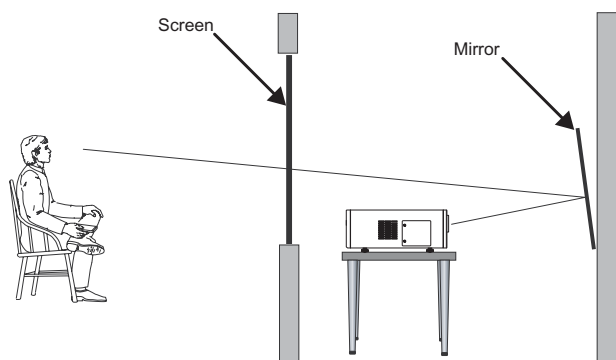

**Figure 3-6. Folded Optics**

Other considerations and tips that can help improve your installation:

- Keep the ambient temperature constant and below 35°C (95°F). Keep the projector away from heating and/or air conditioning vents. Changes in temperature may cause drifts in the projector circuitry, which may affect performance.
- Keep the projector away from devices that radiate electromagnetic energy such as motors and transformers. Common sources of these include slide projectors, speakers, power amplifiers and elevators.

If you are installing a standard LS-10i (without an anamorphic lens), skip this step and proceed with **Mounting the LS-10i** (page 27).

If you are installing an LS-10i with an anamorphic lens, proceed as follows to install the lens mount and transport assembly.



**Note**

1. Do not install the anamorphic lens yet, only the lens mount and transport assembly. You will install the anamorphic lens after you install the projector and adjust the primary lens.
2. Some components shipped with your projector may differ slightly from what is shown in these instructions.

The LS-10i Anamorphic lens mount kit consists of the following items. Some components shipped with your projector may differ slightly from what is shown in these instructions. If any items are missing or damaged, please contact your Runco dealer or Runco Customer Service at (800) 23RUNCO.

◀ **Folded Optics**

◀ **Other Considerations**

### 3.4 Installing the Optional Anamorphic Lens Mount

◀ **Package Contents**

- Transport Assembly Attachment Plate
- Attachment plate hardware (screws, washers and spacers)
- Attachment plate security hooks and related hardware (chain, chain ends, nuts and washers)



- Transport Assembly
- Transport mounting hardware
- Lens bracket mounting hardware
- Power supply
- Remote control unit and batteries



- Anamorphic lens and mounting bracket



**Attaching the Transport Assembly Attachment Plate:**

1. Place the projector upside down on a blanket or other soft surface.

2. Position the attachment plate as shown here.

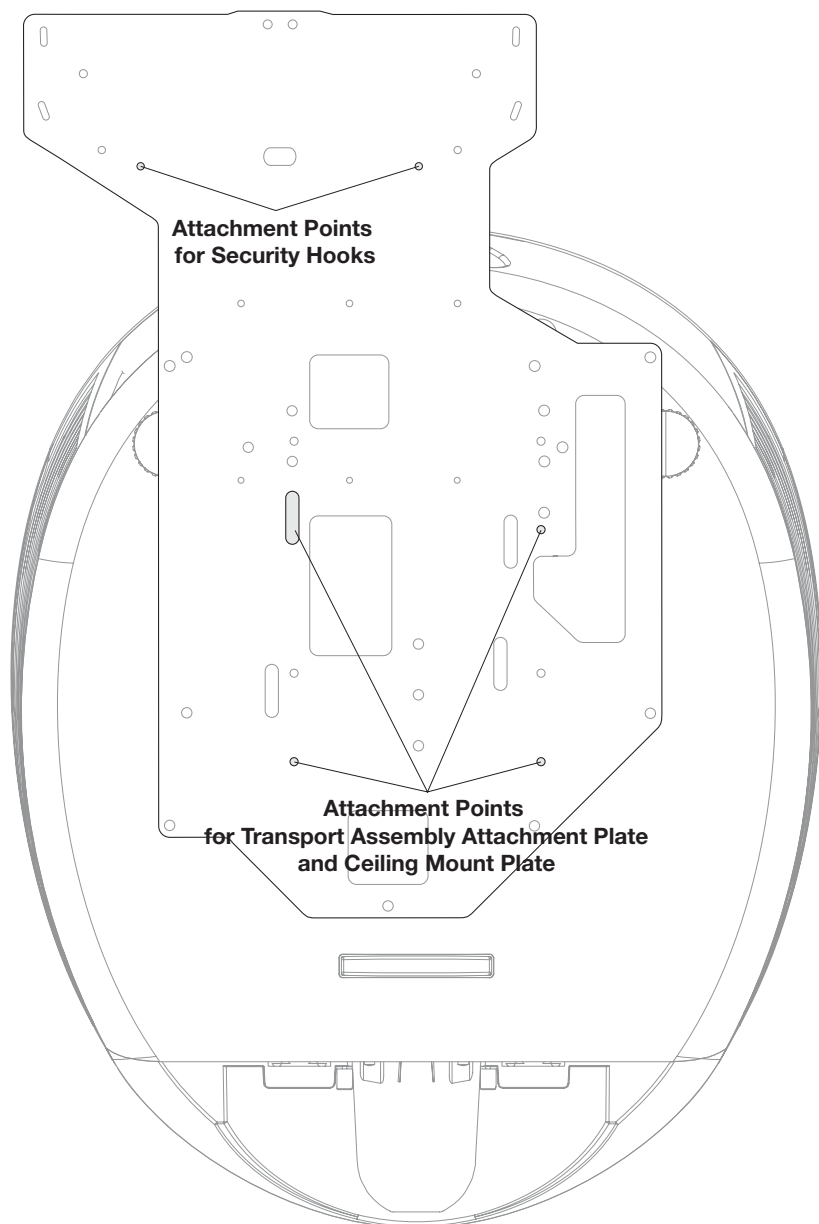

3. **If you are mounting the projector on a ceiling:** Line up the holes on the Ceiling Mount Plate (included with the projector ceiling mount kit) with those on the bottom of the projector and attachment plate.
4. Secure the Transport Assembly Attachment Plate and Ceiling Mount Plate to the projector using the hardware provided with the attachment plate, as shown.



**Caution**

1. **Do not use the mounting screws provided with the ceiling mounting kit.** Use only the hardware provided with the Transport Assembly Attachment plate.

2. **DO NOT OVER-TIGHTEN THE SCREWS.**

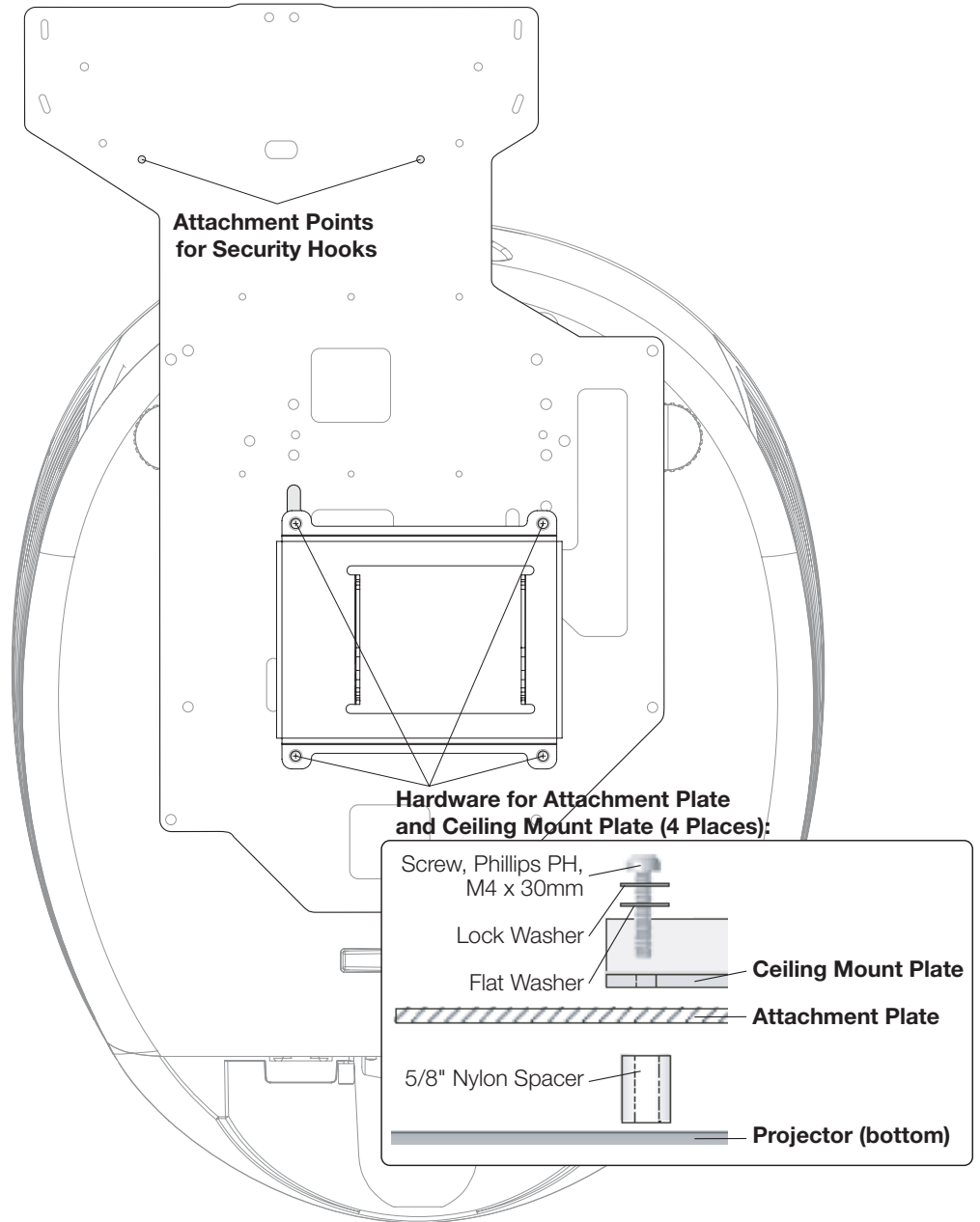

**Installing the Anamorphic Lens Transport Assembly:** After installing the Transport Assembly Attachment Plate and Ceiling Mount Plate, proceed as follows to install the Anamorphic Lens Transport Assembly.

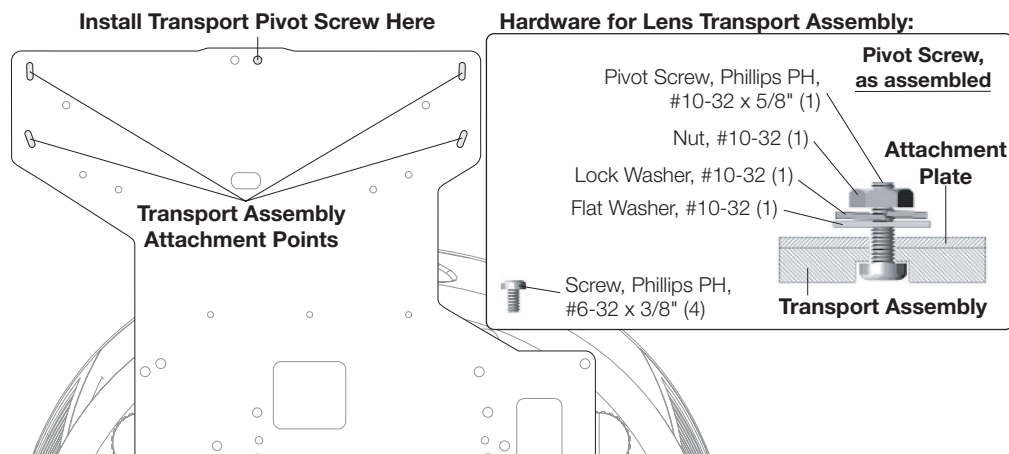

1. Position the flat side of the motorized transport against the bottom side of the Attachment Plate so that the center "M" hole in the Attachment Plate is aligned with the front recessed transport hole.
2. Insert the #10-32 pivot screw up through the transport and Attachment Plate and loosely complete the assembly with the corresponding washer, lock washer and nut.
3. Loosely insert the four small 3/8" screws through the four remaining "M" slots through the top of the Attachment Plate and down into the transport.
4. Separate the Anamorphic Lens and lens bracket. Locate the lens bracket mounting screws and use them to attach the bracket to the transport assembly. Observe the sticker on the plate showing the correct sequence for installing and tightening the screws.

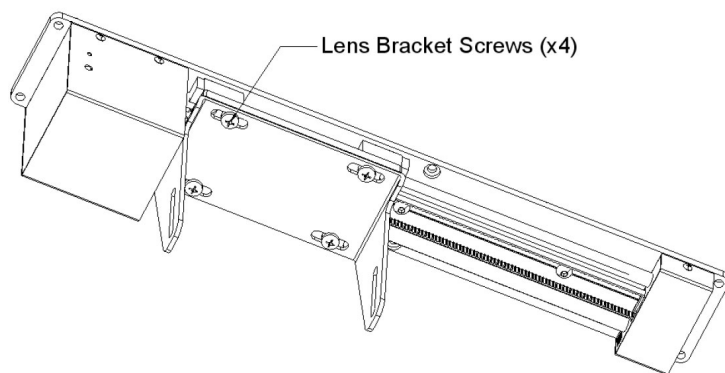

**Attaching the Security Hooks:** To help stabilize and support the added weight of the Anamorphic Lens and Lens Transport Assembly, the attachment plate includes two security hooks and related hardware for attaching the front part of the plate to the ceiling above.

Proceed as follows to attach the security hooks. This requires the following tools and materials:

- Pliers
- Scissors
- Ceiling Hooks (not supplied)

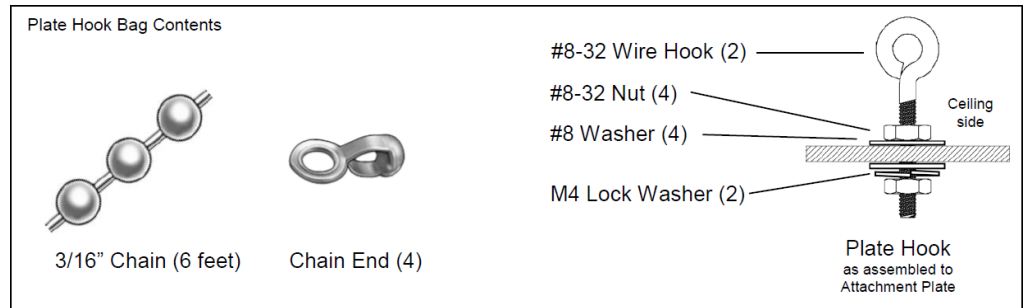

1. Install the Plate Hook Assemblies in the two "H" holes of the Attachment Plate (see diagram on page 23) with the hook ends on the ceiling side as shown above.
2. Use pliers to bend the closed hooks apart just enough to install a Chain End at a later time.
3. Attach the plate hooks to the ceiling as described in the section entitled **Ceiling Mounting (Inverted)**, on the next page.



There are several methods for mounting the projector. Depending on your chosen installation, one method may be more suitable than another.

In typical front and rear screen installations, the projector can be mounted to a secure and level surface such as a table or cart. Carts are useful when moving a projector during a presentation or from site to site. If possible, lock the wheels when it's in position to prevent it from being moved during a presentation.

For fixed installations, and for those that want the projector out of sight or have a limited space for projector and audience, you can invert the LS-10i and suspend it from the ceiling using a specially-designed ceiling mount fixture.



**Note**

*Use only the Runco-approved ceiling mount kit designed for your projector.*

Install the ceiling mount kit according to the instructions provided with it.

If you are ceiling-mounting an LS-10i with an anamorphic lens, perform these additional steps to secure the plate Security Hooks to the ceiling (refer to **Attaching the Security Hooks** on the previous page).

1. Install ceiling hooks (not supplied) into the ceiling directly above the Plate Hooks. The ceiling hooks should be small enough to accept a Chain End but strong enough when installed to each support 40 pounds or more.
2. Attach a Chain End to the Chain and then connect it to one of the ceiling hooks.
3. Cut the Chain to a length equal to or slightly greater than the distance between the ceiling hook and the corresponding Plate Hook.
4. Attach a Chain End to the other end of the Chain. Then, use the Chain to connect the ceiling hook and the Plate Hook.
5. Repeat Steps 2 through 4 for the other ceiling hook/Plate Hook pair.

The projector can also be inverted and placed in an enclosure above and behind the viewing area. Install four feet on the inside bottom surface of the enclosure on which the projector can rest. A variety of materials can be used for this purpose (for example, rubber crutch tips or turntable feet).

## 3.5 Mounting the LS-10i

### ◀ Floor Mounting (Upright)

### ◀ Ceiling Mounting (Inverted)

### ◀ Installing the Projector in an Enclosure

**Adjusting the Projection Angle** ➤

If the LS-10i is ceiling-mounted and the screen is significantly lower than the projector, you can tilt the projector at a slight angle by adjusting the ceiling mount.

The projector can be rotated (side-to-side) up to 360 degrees and mounted without it affecting performance. However, to ensure optimal performance of the lamp, limit the front-to-back tilt of the projector to  $\pm 20$  degrees; see Figure 3-7.

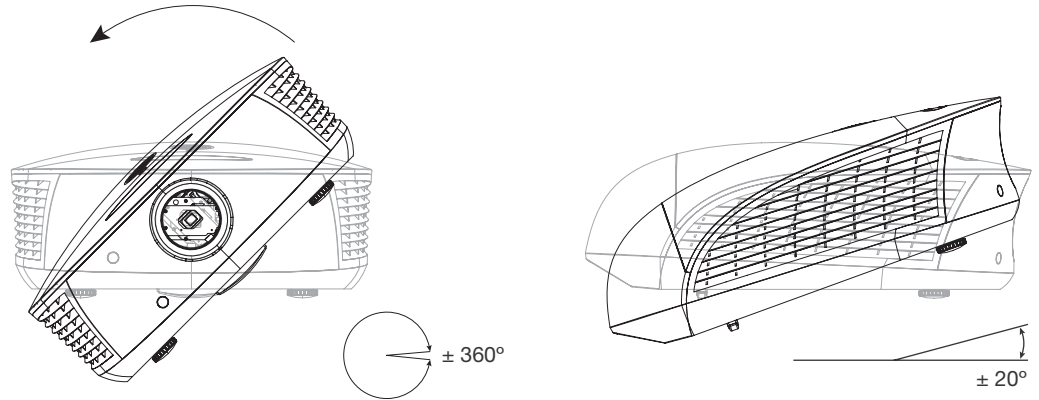

**Figure 3-7. Mounting Angle Ranges (Front-to-Back and Side-to-Side)**

If you do this, you may need to vertically shift the image to compensate. For detailed instructions, refer to **Primary Lens Adjustments** on page 38.



Proceed as follows to connect the LS-10i to your video sources, external controller(s) – if present – and AC power.

When connecting your equipment:

- Use the correct signal cables for each source.
- Ensure that the cables are securely connected. Tighten the thumbscrews on connectors that have them.

Using a flat-blade screwdriver, loosen the two screws holding the rear compartment cover in place.

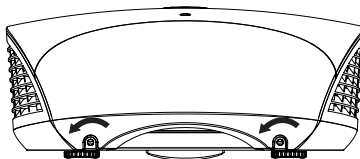

Then, remove the rear compartment cover by tilting it upward.

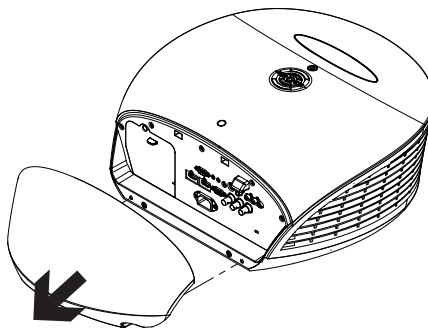

### 3.6 Connections to the LS-10i

#### ◀ Connector Panel Access



**RGBHV Connections:** Connect your personal computer or other RGB source to the **RGB** input. See Figure 3-9.

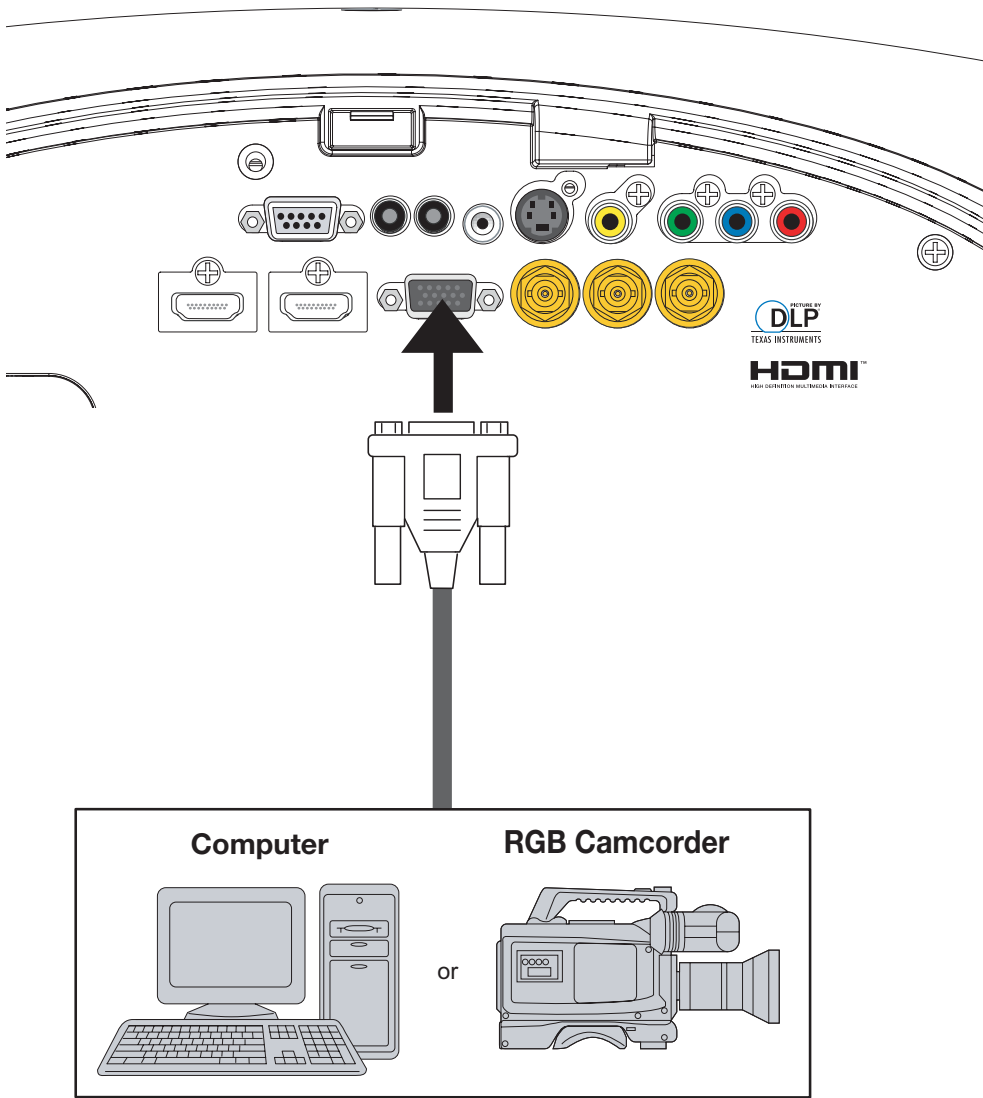

**Figure 3-9. RGBHV Connections**

**SCART RGB Connections:** If the source outputs RGB with composite sync, connect the green, blue and red outputs to the Y, Pb and Pr terminals on the **COMPONENT 1/SCART** input and the sync output to the **VIDEO** input. See Figure 3-10.

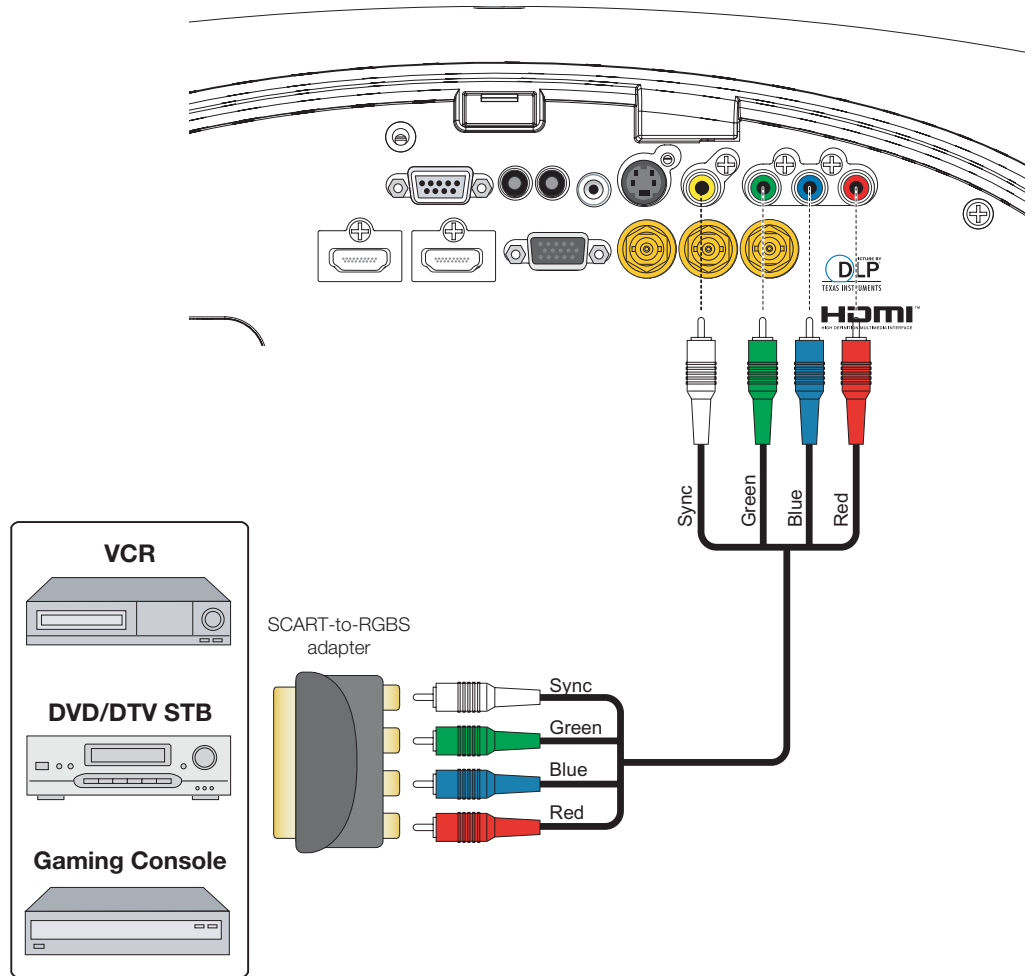
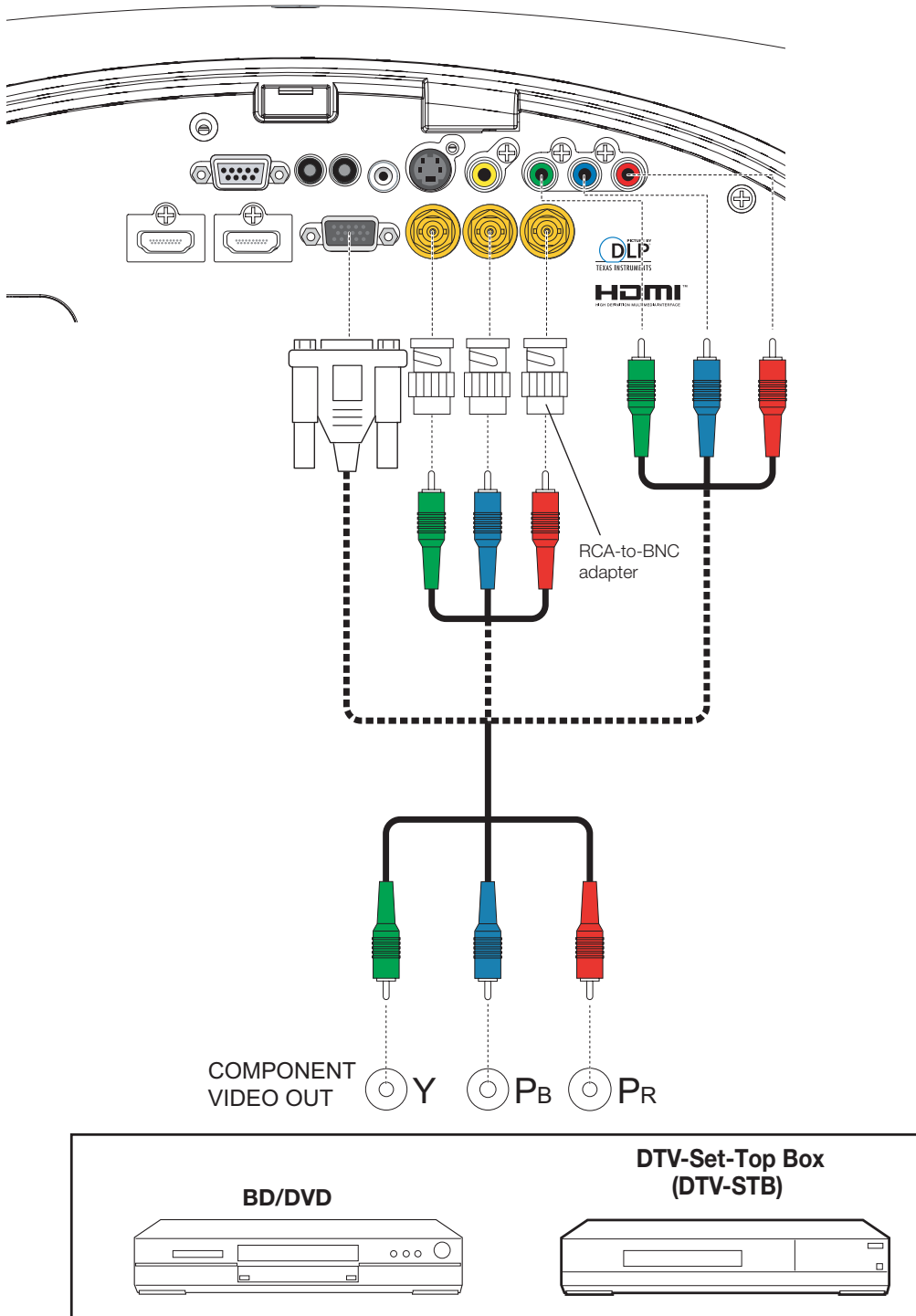

Figure 3-10. SCART Source Connections

**Component Video Connections:** Connect your component video sources to the **COMPONENT 1/SCART**, **COMPONENT 2** or **RGB** inputs as shown in Figure 3-11.



**Figure 3-11. Component Video Connections**

**Composite/S-Video Connections:** Connect your Composite and S-Video sources to the LS-10i as shown in Figure 3-12.

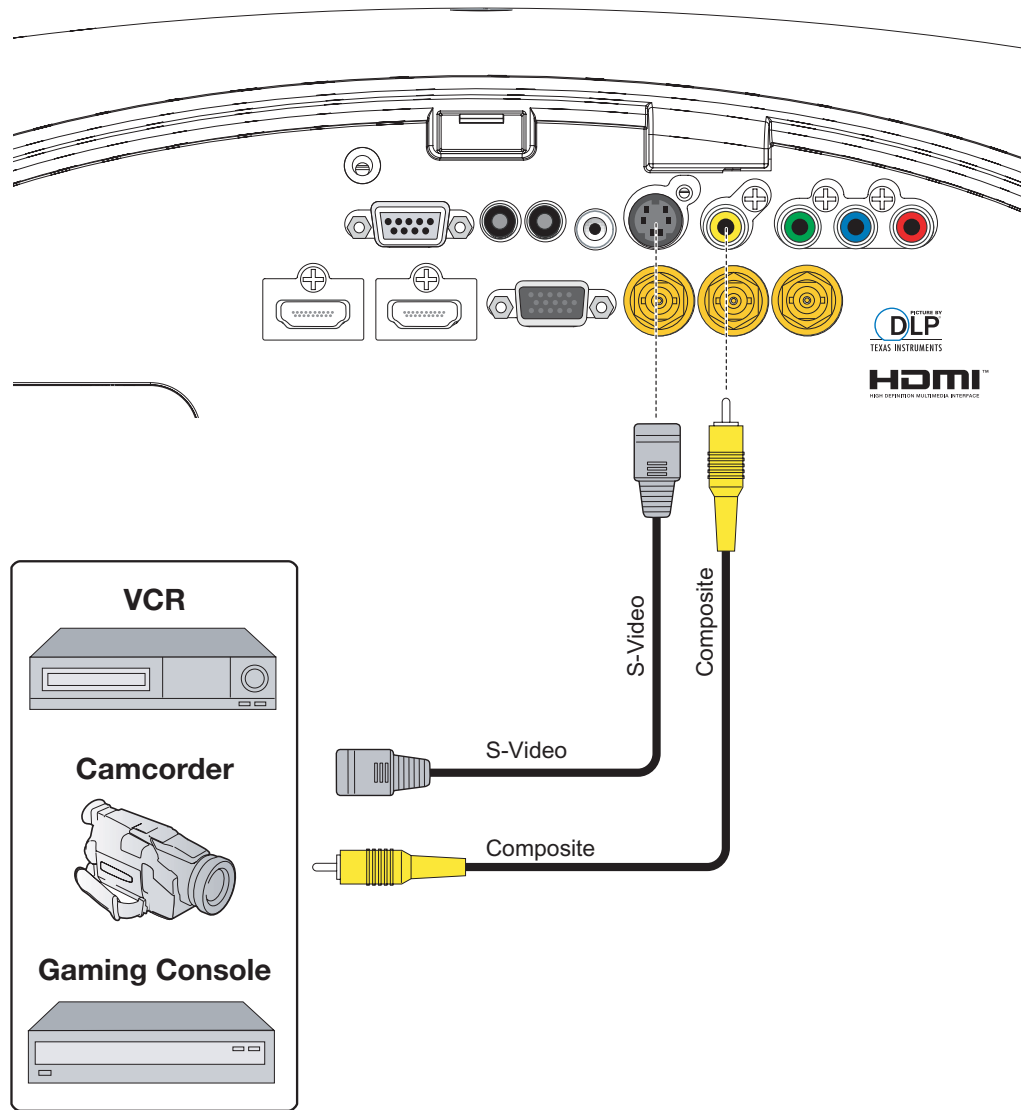

**Figure 3-12. Composite and S-Video Connections**

Connect a PC or home theater control/automation system (if present) to the RS-232 port on the LS-10i; see Figure 3-13. Use a standard, 9-pin serial cable, wired straight-through. For more information about using this connection, refer to **External Control** on page 75.

◀ **RS-232 Controller Connection**

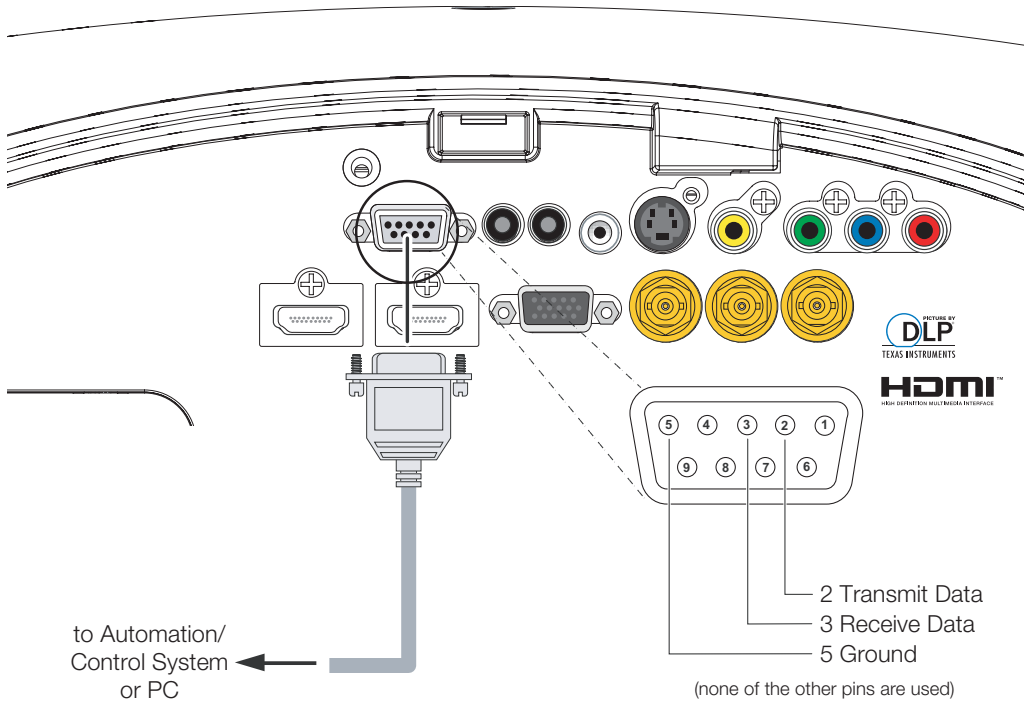

**Figure 3-13. RS-232 Control System Connection**

**Connecting 12-Volt Trigger Output to External Theater Equipment**

If your home theater contains a retractable screen, screen mask or other 12-volt trigger-activated equipment, connect it to the 12-volt trigger output(s) as shown in Figure 3-14.



**Tip**

If you are installing an LS-10i with an anamorphic lens, connect the lens transport to the **TRIGGER 2** output. This output is factory-configured to activate when a wide-screen aspect ratio (Cinema or Virtual Cinema) is chosen.

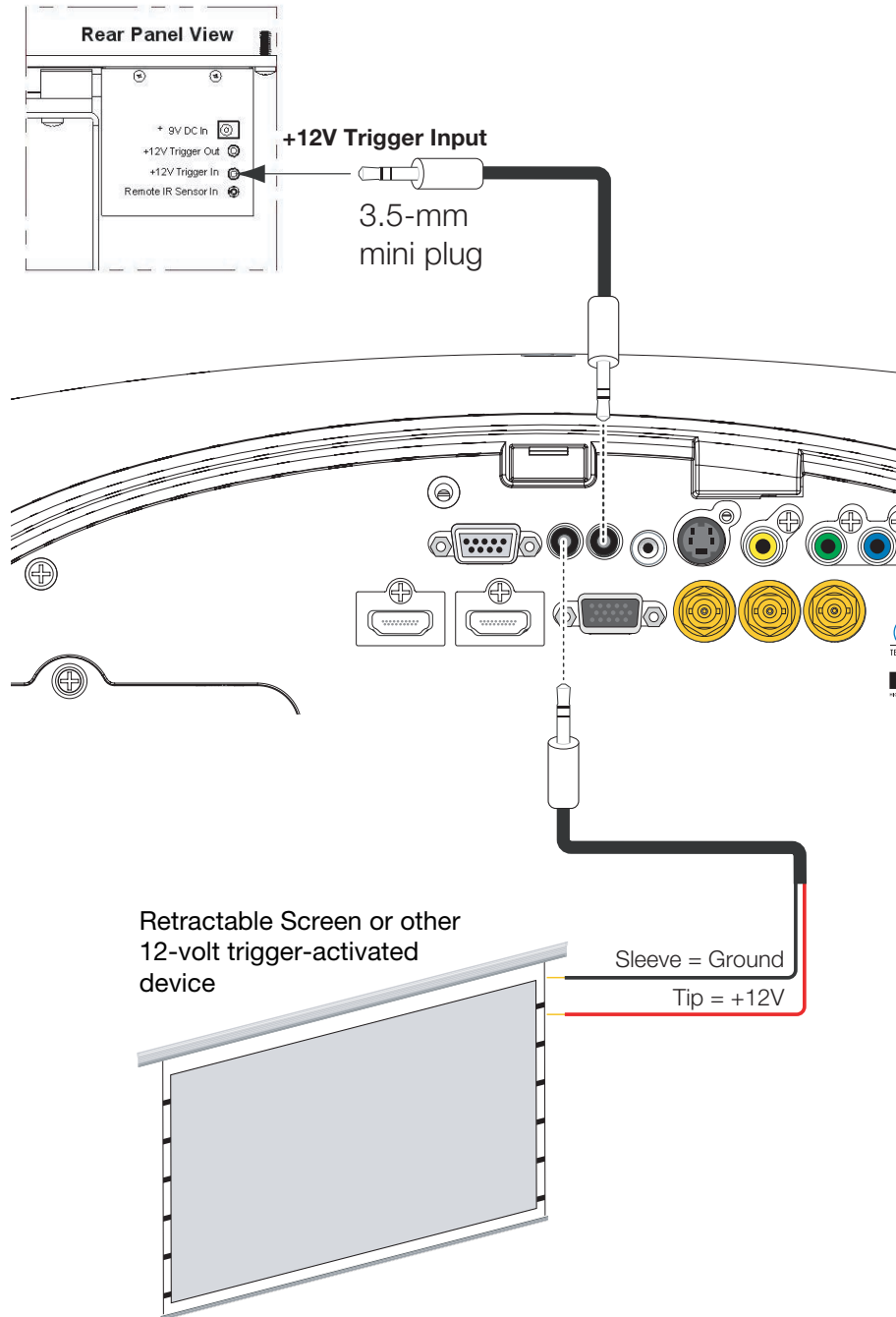
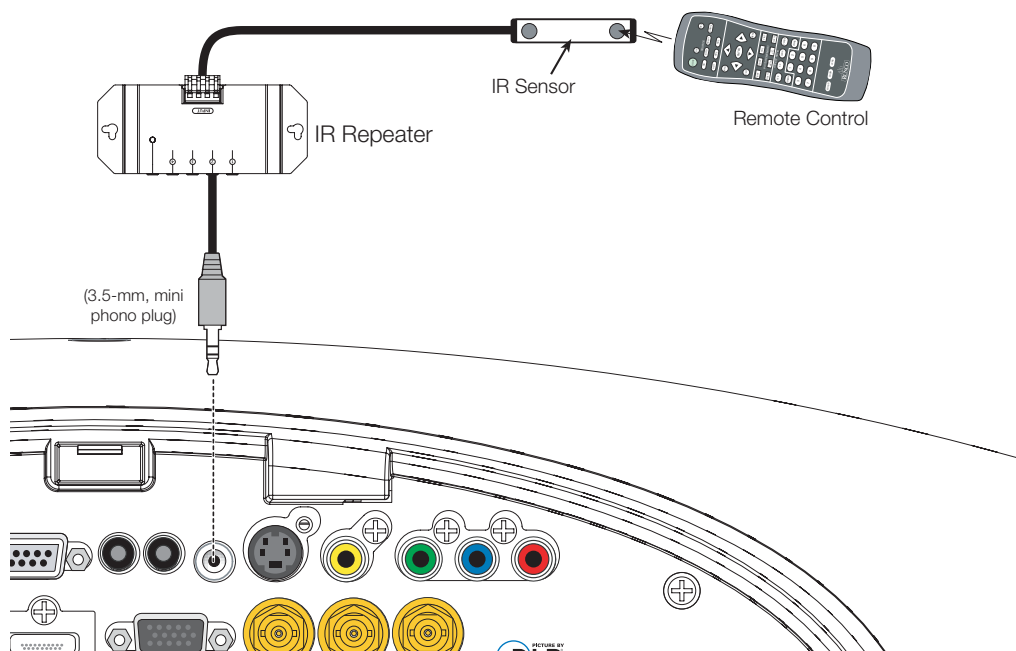

**Figure 3-14. 12-Volt Trigger Output Connection**



If infrared signals from the remote control cannot reach the projector due to excessive distance or obstructions such as walls or cabinet doors, you can connect an external IR repeater system to the IR INPUT on the LS-10i to extend the range of the remote control. See Figure 3-15.

◀ **Connecting an External IR Receiver**



**Figure 3-15. External IR Receiver Connection**

The LS-10i ships with various types of AC power cords. Choose the one that is appropriate to your locale.

◀ **Connecting to AC Power**

**Projector:** Plug the female end of one power cord into the AC receptacle on the rear of the LS-10i (AC 100V ~ 240V). Then, connect the other end to your AC power source.

**Anamorphic Lens Transport:** An AC-to-DC power adapter is provided for the lens transport. Connect the power adapter to the **+9V DC In** jack on the rear of the lens transport assembly. Connect the other end to an AC power source.

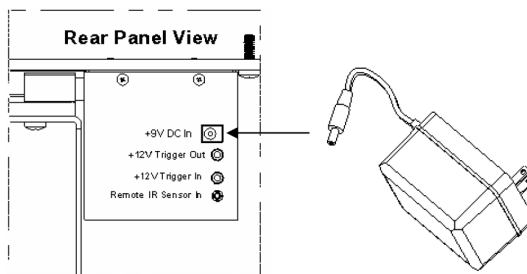

---

### 3.7 Turning on the Power

1. Turn on your source components.
2. Press the **ON** button on the remote control to turn on the LS-10i. The LED flashes green to indicate that it is warming up.
3. When the projector is ready for use, the LED turns off.

---

### 3.8 Primary Lens Adjustments

To access the motorized lens controls, use the **FOCUS**, **ZOOM** and **LENS** buttons on the LS-10i remote control unit (described on page 11).

Alternatively, press **MENU** on the remote control. Select Control from the Main Menu, then press **▲** or **▼** to highlight Lens Control.

The LS-10i gives you a great deal of control over the picture size, position and focus.

- Focus** ➤ To access the motorized lens focus control, press **◀** or **▶** to highlight Focus and press **ENTER**. Then, use the **▲** button to focus the projected image nearer or the **▼** button to focus the projected image farther away.
- Zoom** ➤ To access the motorized lens zoom control, press **◀** or **▶** to highlight Zoom and press **ENTER**. Then, use the **▲** button to make the picture larger (zoom in) or the **▼** button to make the picture smaller (zoom out).
- Lens Shift** ➤ To access the motorized lens shift control, press **◀** or **▶** to highlight Lens Shift and press **ENTER**. Then, use the **▲** and **▼** buttons to adjust the vertical lens position or the **◀** and **▶** buttons to adjust the horizontal lens position.

**Installing the Optional Stray Light Shield:** For installations that require significant vertical lens shift (50% or more of the screen height), a lens shield is provided with the LS-10i that minimizes stray light around the image.

The light shield attaches to threads at the end of the lens. Or, if you have installed a lens filter, you can attach the light shield to it.

To install or remove the light shield, squeeze the two side "wings" to snap it into place or release it.

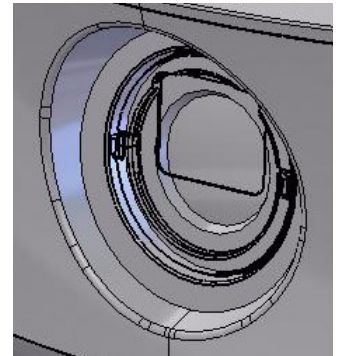

**Caution**

*Do not use the stray light shield unless the amount of vertical lens shift exceeds 50 per cent of the screen height.*

When you turn on the LS-10i for the first time, the OSD Language Menu appears.

The LS-10i can display the menus in English, French, German, Italian, Spanish, Swedish, Portuguese or Russian.

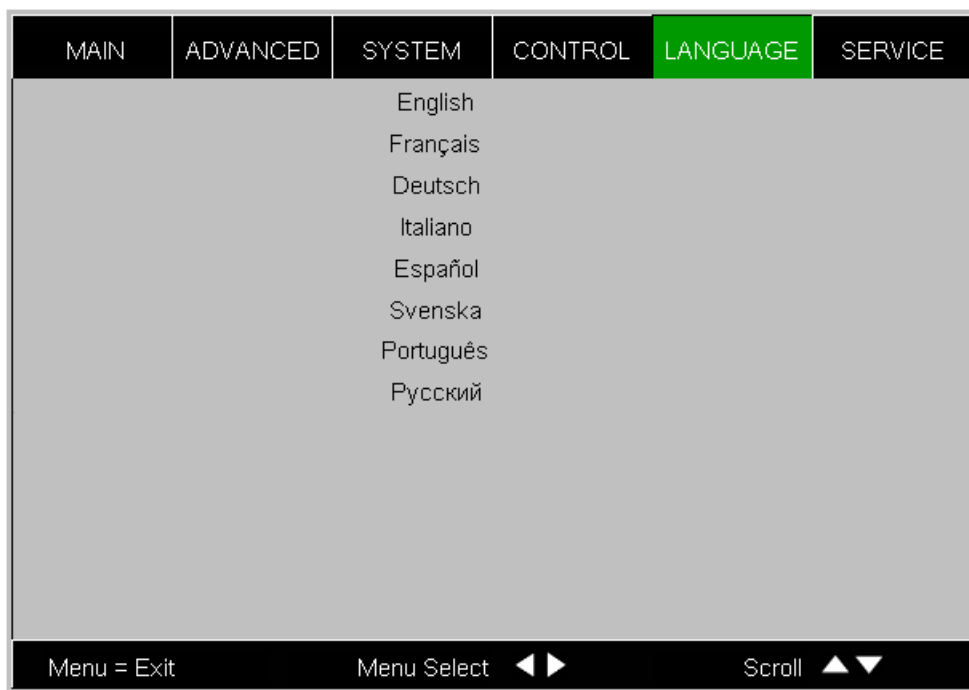

Press ▲ or ▼ to select a language. Then, press **ENTER** to confirm your selection.

If the LS-10i is installed behind the screen, you must change the picture orientation to match the installation method. To do this, press **MENU** on the remote control. Then, select System from the Main Menu.

If the projector is used in a rear-projection application (see Figure 3-6), press ▼ repeatedly to select Rear Projection from the System Menu. Press ◀ or ▶ to set it to **On**.

If the projector is ceiling-mounted, the LS-10i automatically inverts the image. If this automatic inversion is not desired, select Ceiling Mode from the System Menu and set it to **Off**.

### 3.9 Changing the OSD Language

### 3.10 Adjusting the Picture Orientation

◀ *Rear Projection*

◀ *Ceiling Mode*

### 3.11 Installing and Adjusting the Anamorphic Lens

If you are installing an LS-10i with an anamorphic lens, proceed as follows to install and adjust the lens.



**Note**

*It is extremely important that the primary lens is properly adjusted before you install the anamorphic lens. Ensure that the image from the primary lens is perfectly centered on the screen.*

#### Anamorphic Lens Installation and Adjustment

Attach the anamorphic lens to the bracket using the plastic knobs supplied with the lens. See Figure 3-16.

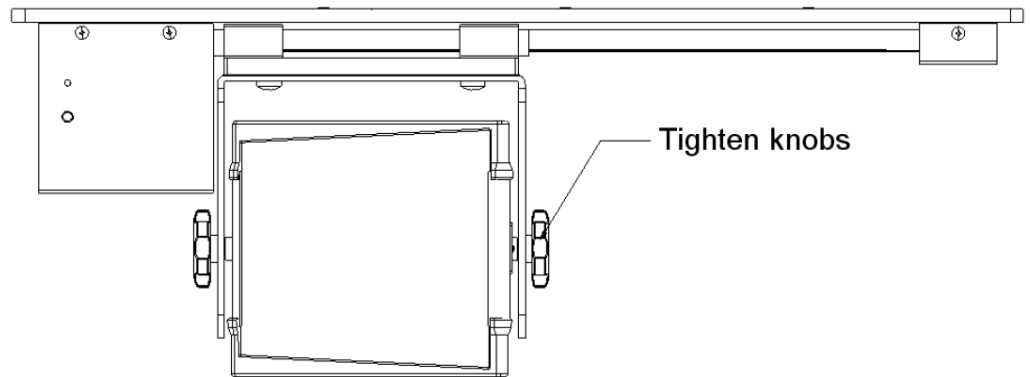

**Figure 3-16. Attaching the Anamorphic Lens to the Lens Mount**

**Configure Lens Motor Trigger:** The anamorphic lens solution for the LS-10i maintains constant image height independent of the aspect ratio, while using the full display resolution of the projector. It accomplishes this by moving the anamorphic lens in front of the primary lens when widescreen material is being viewed. When the viewer transitions back to 16:9 or 4:3 source material, the anamorphic lens moves out of the light path.

Proceed as follows to confirm that the +12V trigger output to which the lens transport is connected is configured for proper operation.



**Note**

*You can skip this step if you connected the lens transport motor to the **TRIGGER 2** output on the LS-10i, as shown in Figure 3-14.*

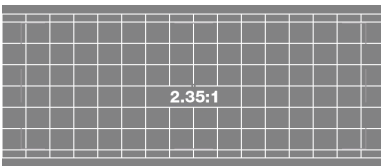

1. Project a 2.35:1 aspect ratio test pattern or other image on the screen.
2. Press **MENU** on the remote control.
3. Press ◀ or ▶ to select Control from the Main Menu.
4. If the +12V trigger output to which the lens transport is connected is set to **AutoScope**, skip to Step 7. Otherwise, continue with Step 5.
5. Press ▲ or ▼ to highlight Trigger 1 or Trigger 2.
6. Press ◀ or ▶ to select **AutoScope**.

7. Select the Cinema aspect ratio to move the anamorphic lens into position, if it isn't already. To do this, press **CINEMA** on the LS-10i remote control (refer to **LS-10i Remote Control** on page 9).

#### Adjusting the Lens Position:

1. Adjust the vertical position and tilt of the lens so that the projector beam is passing through the center of the lens and any residual pincushion distortion is about the same at the top and bottom of the image. This typically results in the anamorphic lens being below the center of the primary lens and tilted slightly downward.
2. Tighten the knobs.



#### Note

*There may be some pincushion distortion even after the lens is properly adjusted, especially at shorter throw distances. If this is the case, Runco recommends that you slightly over-scan the image into the screen frame area to mask the distortion.*

3. Adjust the rotation of the Lens Transport Assembly so that the left and right sides of the image are an equal distance from their respective screen borders.
4. Tighten the Pivot Screw and the four mounting screws holding the transport to the Attachment Plate.
5. For optimum multiple aspect ratio performance, adjust the projector's zoom so that a 1.85:1 aspect ratio movie is just masked by the top and bottom of the screen border when the anamorphic lens is not in front of the primary lens. This way 1.85:1, 16:9 and 2.35-2.4:1 aspect ratio movies are all presented to fill the screen at a constant height.
6. Remove the protective film from the front of the anamorphic lens.



**Notes:**

# 4. Operation

When you turn on the LS-10i, it switches to the last selected input and looks for a valid signal.

Use these buttons on the remote control to select an input source directly.

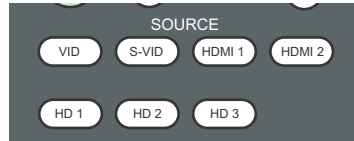

You can assign the HD 1, HD 2 and HD 3 buttons to any input, or to the Picture-in-Picture (PIP) function. The default assignments are: HD 1 = Component 1, HD 2 = Component 2, HD 3 = RGB.

For more information, refer to **HD 1 Key / HD 2 Key / HD 3 Key** on page 66.

Use these buttons to select the appropriate aspect ratio for the type of program material being viewed. Refer to Table 4-2 for more information.

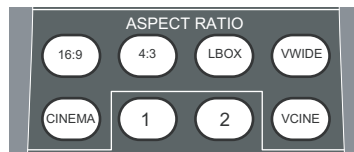

Press **CUST1**, **ISF NIGHT**, **ISF DAY** or **CUST2** to recall settings from a memory preset. Then, press **ENTER** to confirm your selection. Or, to cancel the operation, press **▶** to select **Cancel** and press **ENTER**.



## 4.1 Selecting An Input Source

## 4.2 Selecting An Aspect Ratio

## 4.3 Selecting Video Memory

## 4.4 Using Picture-In-Picture (PIP)

For PIP purposes, there are three groups of inputs separated by their display modes:

- **Video (SD) group:** Video, S-Video and SCART inputs.
- **Graphic (HD) group:** Component 1, Component 2 and RGB inputs.
- **Digital Video group:** HDMI 1 and HDMI 2 inputs.

PIP shows one input from any of these groups within or beside one input from either of the other two groups.

- If you have assigned the HD 1, HD 2 or HD 3 button to the PIP function, press that button to activate PIP. Once activated, press that button repeatedly to select the desired PIP source or turn PIP off.
- When PIP is active, press **ENTER** to swap the main and PIP images.

For more information, refer to **PIP Position** on page 64.

For each source, Table 4-1 shows which of the other sources are available as a PIP source.

**Table 4-1. Available Main and PIP Source Combinations**

		PIP Input Source							
		VIDEO	S-VIDEO	SCART	COMP 1	COMP 2	RGB	HDMI 2	HDMI 1
<b>Main Input Source</b>	VIDEO	-	-	-	✓	✓	✓	✓	✓
	S-VIDEO	-	-	-	✓	✓	✓	✓	✓
	SCART	-	-	-	✓	✓	✓	✓	✓
	COMP 1	✓	✓	✓	-	-	-	✓	✓
	COMP 2	✓	✓	✓	-	-	-	✓	✓
	RGB	✓	✓	✓	-	-	-	✓	✓
	HDMI 2	✓	✓	✓	✓	✓	✓	-	-
	HDMI 1	✓	✓	✓	✓	✓	✓	-	-

Notes:

1. "✓" means that that source is available as a PIP source with a given main source; "-" means that it is not.
2. Disabled sources (refer to **Input Enable** on page 63) are not available as PIP sources.



1. Press the **MENU** button on the remote control or system keypad to display the Main Menu.
2. There are six menus. Press ◀ or ▶ to select a sub-menu.
3. Press ▲ or ▼ to select a sub-menu item.
4. For each sub-menu item, the currently-selected value appears in white text or is otherwise highlighted. Press ◀ or ▶ to choose a setting for that item, or press **ENTER** to go to another sub-menu.
5. Press **MENU** to return to the previous menu.
6. From the Main Menu, press **MENU** to turn off the OSD menu.

## 4.5 Using the On-Screen Menus

The LS-10i OSD menus are arranged hierarchically, as shown in Figure 4-1. Depending on the selected input source and signal characteristics, some menu options may not be available.

<b>Main</b>	Aspect Ratio	<b>16:9</b> , 4:3, Letterbox, VirtualWide, Cinema or Virtual Cinema	
	Memory	Recall Memory	
		Save Settings	
		Save ISF	
	Brightness	<b>0</b> , 1, 2 ... <b>100</b>	
	Contrast		
	Color		
	Tint		
	Sharpness	<b>0</b> , 1, 2 ... 100	
	Noise Reduction		
	Overscan	<b>Off</b> , Crop or Zoom	
	Input Select	<b>HDMI 1</b> , HDMI 2, RGB, Comp. 1, Comp. 2, Video, S-Video or SCART	
	PIP Select	<b>Off</b> , HDMI 1, HDMI 2, RGB, Comp. 1, Comp. 2, Video, S-Video or SCART	
Resync	(press ENTER to execute)		
<b>Advanced</b>	Color Space	<b>Auto</b> , REC709, REC601, RGB-PC or RGB-Video	
	Video Standard	<b>Auto</b> , NTSC, PAL or SECAM	
	Gamma	2.5, 2.35, <b>2.2</b> , 2.0 or 1.8	
	Color Temperature	5500K, <b>6500K</b> , 7500K, 9300K or Native	
	DLP Frame Rate	<b>Auto</b> , 48 Hz, 50 Hz or 60 Hz	
	Color Gamut	<b>Auto</b> , REC709, SMPTE-C, EBU, Native or PCE	
	ConstantContrast	<b>On</b> or Off	
	Adaptive Contrast	On or <b>Off</b>	
	RGB Adjust	Red / Green / Blue Offset	
		Red / Green / Blue Gain	
		Fine Sync	V. Position
			H. Position
			Phase
	Tracking		
	Sync Level		
	PCE	Red x, y / Green x, y / Blue x, y	
		Yellow x, y / Cyan x, y / Magenta x, y	
White x, y			

<b>System</b>	Input Enable	<b>Off</b> (SCART) or <b>On</b> (all others) for each source
	PIP Position	Top Left, <b>Top Right</b> , Bottom Left, Bottom Right, Picture-by-Picture or Split Screen
	Menu Position	Top Left, Top Right, Bottom Left, Bottom Right or <b>Center</b>
	Translucent Menu	0% (opaque), <b>25%</b> , 50% or 75%
	Lamp Power	Economy or <b>Standard</b>
	Blank Screen	<b>Black</b> , Blue or White
	Auto Power Off	On or <b>Off</b>
	Auto Power On	
	Rear Projection	
	Ceiling Mode	<b>Auto</b> , On or Off
	Logo Display	<b>On</b> or Off
	Power On Chime	
	<b>Control</b>	Lens Control
HD 1 Key		HDMI 1, HDMI 2, <b>RGB</b> (HD 3), <b>Comp. 1</b> (HD 1), <b>Comp. 2</b> (HD 2), Video, S-Video, SCART or PIP
HD 2 Key		
HD 3 Key		
CineWide		<b>Off</b> , CineWide or AutoScope
Trigger 1		<b>AutoScope</b> (Trigger 2), <b>Lamp</b> (Trigger 1), 4:3 or RS-232
Trigger 2		
HDMI CEC	<b>On</b> or Off	
<b>Language</b>	<b>English</b> , French, German, Italian, Spanish, Swedish, Portuguese or Russian	
<b>Service</b>	Model Name	(read-only)
	Unit Serial Number	
	Software Version	
	Active/PIP Source	
	Pixel Clock	
	Signal Format	
	H/V Refresh Rate	
	Lamp Hours	
	Lamp Hour Reset	Reset? (Yes or No)
	Factory Reset	Reset Everything? (Yes or No)
	Blue Only	On or Off
Test Patterns	On or Off	
Altitude	Auto or High	

**Note:** Default settings appear in bold type.

**Figure 4-1. LS-10i OSD Menu Structure**

**Main** ➤ The LS-10i Main Menu, shown in Figure 4-2, provides access to the most commonly-used projector functions.



**Note**

1. For best results, Runco recommends that you set *ConstantContrast* to **Off** before adjusting *Brightness*, *Contrast* and other image quality settings in this menu (refer to **ConstantContrast** on page 57). After you have completed the initial calibration, set *ConstantContrast* to **On** if desired.
2. Image controls only operate on the active source. To adjust the PIP source, switch to the PIP source (thereby making it the active source), adjust the controls and then switch back.

MAIN	ADVANCED	SYSTEM	CONTROL	LANGUAGE	SERVICE
Aspect Ratio		16:9 Letterbox	4:3 VirtualWide	Cinema	V-Cinema
Memory				Enter	
Brightness				100	
Contrast				100	
Color				100	
Tint				100	
Sharpness				100	
Noise Reduction				100	
Overscan		Off		Crop	Zoom
Input Select				Enter	
PIP Select				Enter	
Resync				Enter	
Menu = Exit		Menu Select ◀▶		Scroll ▲▼	

**Figure 4-2. LS-10i Main Menu**

**Aspect Ratio:** To change the aspect ratio (size and shape) of the projected image, press ▲ or ▼ to highlight Aspect Ratio. Use the ◀ or ▶ buttons to select the appropriate aspect ratio for your screen size, installed lens configuration and the type of program material being viewed, then press **ENTER**; refer to Table 4-2.

Note that some aspect ratios are unavailable and/or not useful with certain types of source material. The optimal setting depends on a number of factors, such as:

- The aspect ratio of the source material, as broadcast or encoded on the playback medium.
- The “display type” (16:9 or 4:3) and output resolution settings at the source component. Most modern DVD/BD players and set-top boxes have such controls.
- Viewer preference (original aspect ratio with “black bars,” or a full-screen presentation with some distortion or cropping).

**Table 4-2. Aspect Ratio Settings**

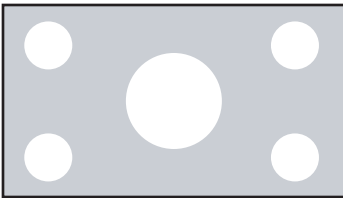
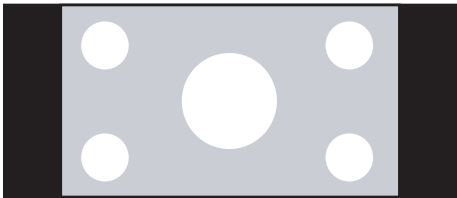
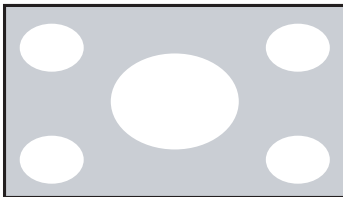
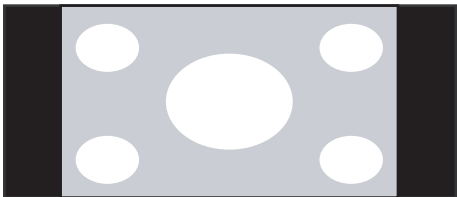
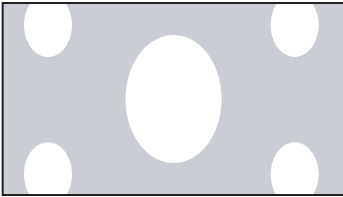
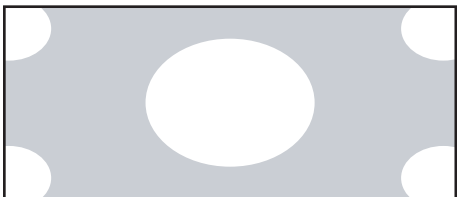
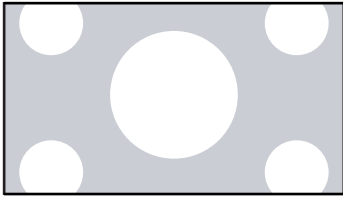
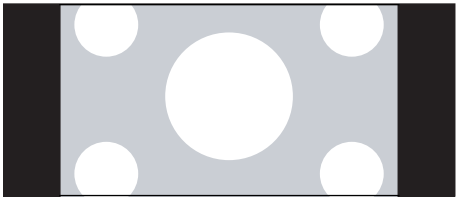
Aspect Ratio Setting	Description	Aspect Ratio of Source Signal	Geometry of Projected Image	
			With Standard Lens (1.78:1 Screen)	With Anamorphic Lens (2.35:1 Screen)
<b>16:9</b>	16:9 linearly scales the source active image horizontally and vertically to fill a 16:9 screen.	16:9		
		4:3		
<b>Letterbox</b>	With a 16:9 source image, Letterbox mode crops the top and bottom portion of the image and vertically stretches the remaining portion to fill a 16:9 image area.	16:9		
	It scales (zooms in on) a 4:3 image linearly (by the same amount on all sides) to fill a 16:9 display.	4:3		

**Table 4-2. Aspect Ratio Settings (continued)**

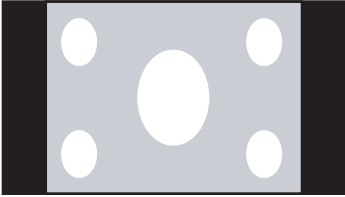
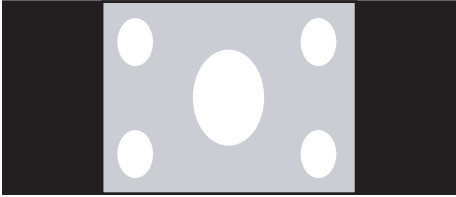
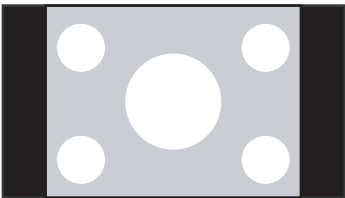
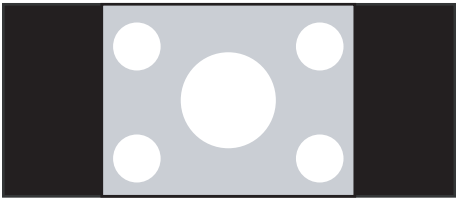
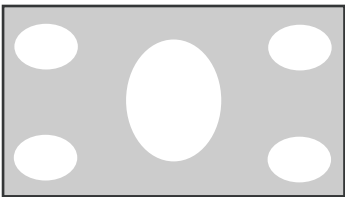
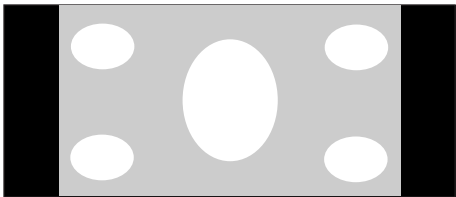
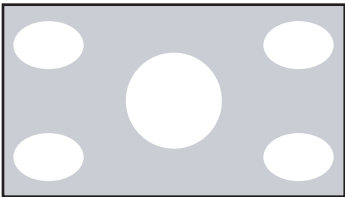
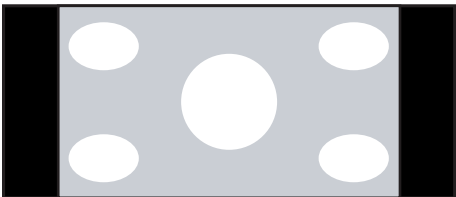
Aspect Ratio Setting	Description	Aspect Ratio of Source Signal	Geometry of Projected Image	
			With Standard Lens (1.78:1 Screen)	With Anamorphic Lens (2.35:1 Screen)
<b>4:3</b>	4:3 linearly scales the source active image horizontally and vertically to fill a 4:3 rectangle which is centered and the same height as the 16:9 designated image area. The remaining area is black.	16:9		
		4:3		
<b>Virtual-Wide</b>	A 16:9 image is shrunk horizontally in the center and stretched horizontally in a NON-linear fashion (more on the sides).  A 4:3 image is horizontally scaled in a NON-linear fashion (more on the sides than in the center) to fit a 16:9 screen.	16:9		
		4:3		

**Table 4-2. Aspect Ratio Settings (continued)**

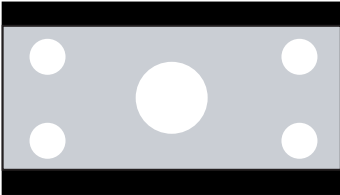
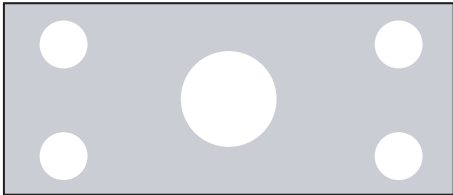
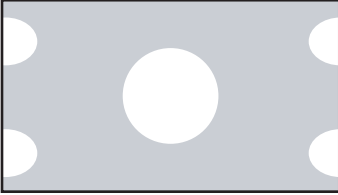
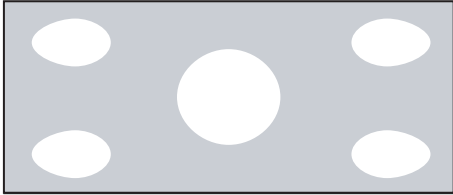
Aspect Ratio Setting	Description	Aspect Ratio of Source Signal	Geometry of Projected Image	
			With Standard Lens (1.78:1 Screen)	With Anamorphic Lens (2.35:1 Screen)
<b>Cinema</b>	<p>Select Cinema to view 2.35 source material in its native aspect ratio.</p> <p>With a 16:9 screen and a standard LS-10i (without an anamorphic lens), the upper and lower portions of the screen are masked, but the geometry of the active image area is unchanged.</p> <p>With a 2.35:1 screen and an anamorphic lens, the video processor scales the 2.35:1 image so that the active image area fills the 16:9 chip surface, eliminating the black bars. The secondary, anamorphic lens then restores the proper geometry to the 2.35:1 image.</p>	2.35:1		
<b>Virtual Cinema</b>	<p>A 16:9 image is scaled NON-linearly (more on the sides than in the center) to fit a 2.35:1 screen.</p>	16:9		

**Memory:** Select Memory from the Main menu, then press **ENTER** to recall image quality settings previously saved, or to save changed settings in any of four memory locations.

- **Recall Memory:** Select Recall Memory from the Memory menu to recall saved image quality settings. Unless you select **Default** (see below), this control affects all sources, not just the active source.
  - **Custom 1** and **Custom 2** contain the factory default settings when the projector is initially turned on.
  - When you recall the **ISF Day** or **ISF Night** memory settings, all settings associated with these stored values are grayed out. This prevents unintended adjustments from being made. To remove this restriction, choose **Custom 1** or **Custom 2**.

**ISF Day** and **ISF Night** are grayed out unless these custom settings have already been saved.

- Choose **Default** to restore the factory-default settings for the active source only. The other sources are unaffected.
- **Save Settings:** Select Save Settings from the Memory menu to save any image-related settings you have changed to **Custom 1** or **Custom 2**.

The following items are saved (for **all** sources, not just the active source):

- Brightness / Contrast
- Color / Tint
- Sharpness (all settings in sub-menu)
- Noise Reduction (all settings in sub-menu)
- Color Space
- Video Standard
- Gamma
- Color Temperature
- DLP Frame Rate
- Color Gamut and PCE settings
- Constant Contrast
- Adaptive Contrast
- RGB Adjust (all settings in sub-menu)
- Lamp Power
- **Save ISF:** Select Save ISF from the Memory menu to save any image-related settings you have changed to the **ISF Day** or **ISF Night** memory location.



**Note**

**You must enter a passcode to access the Save ISF sub-menu.**

The settings that are saved are the same as those saved with the **Save Settings** command (see above).

**Brightness:** On your external test pattern source, select a PLUGE pattern. (PLUGE is an acronym for “Picture Line-Up Generation Equipment.”) Figure 4-3 shows a typical PLUGE pattern.

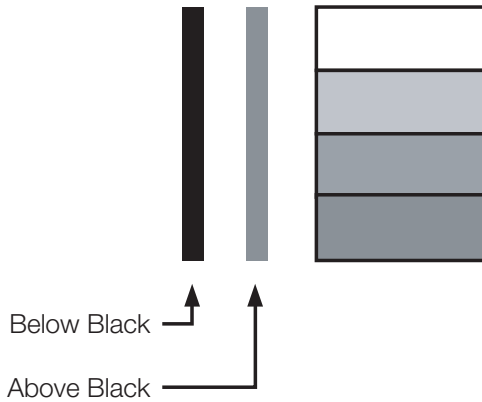

**Figure 4-3. Typical PLUGE Pattern for Adjusting Brightness**

PLUGE patterns vary but generally consist of some combination of black, white and gray areas against a black background. The example above includes two vertical bars and four shaded boxes.

Select Brightness from the Main menu. Use the ◀ or ▶ buttons to adjust the level so that:

- The darkest black bars disappear into the background.
- The dark gray areas are barely visible.
- The lighter gray areas are clearly visible.
- The white areas are a comfortable level of true white.
- The image contains only black, gray and white (no color).

**Contrast:** On your external test pattern source, select a stepped, gray-bar pattern like the one shown in Figure 4-4.



**Figure 4-4. Typical Gray Bar Pattern for Adjusting Contrast**

Select Contrast from the Main menu. Use the ◀ or ▶ buttons to adjust the contrast up until the top two bars become almost the same brightness, then down just until the brightness change between these bars is consistent with the other bars.

**Note**

*Brightness and Contrast controls are interactive. A change to one may require a subtle change to the other in order to achieve the optimum setting.*

**Color:** To adjust the overall color intensity, select Color from the Main menu. Decrease this setting if colors are overly saturated; increase it if colors appear muted or washed out.

**Tint:** Tint or “hue” is the ratio of red to green in the color portion of the image. To adjust the tint, select Tint from the Main menu. Decrease this setting to shift the hue toward red; increase it to shift the hue toward green.

**Note**

*Like the Brightness and Contrast controls, the color and tint controls are interactive. A change to one may require a subtle change to the other in order to achieve the optimum setting.*

**Sharpness:** “Sharpness” is the amount of high-frequency detail in the image. To adjust this, select Sharpness from the Main menu and press **ENTER**. On your external test pattern source, select a pattern like the one shown in Figure 4-5.

Adjust as needed, looking for white edges around the transitions from black to gray and differently-sized lines in the “sweep” patterns at the top and bottom. Lower the sharpness setting to eliminate them.

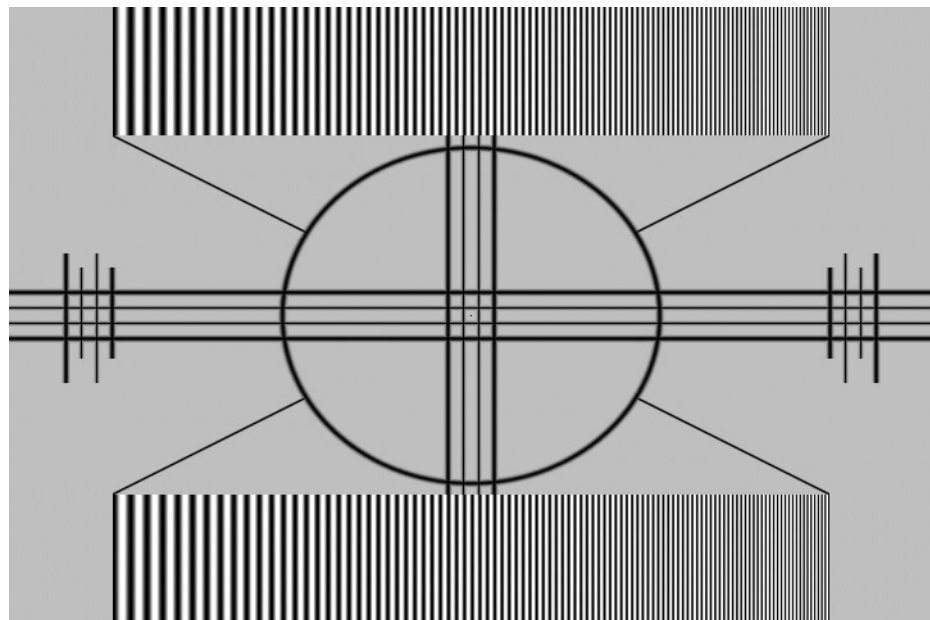

**Figure 4-5. Typical Test Pattern for Adjusting Sharpness**

**Noise Reduction:** To apply noise reduction to the source signal, select Noise Reduction from the Main menu and press **ENTER**. Noise Reduction is useful for clearing up noisy images from interlaced SD sources.

Use the ◀ or ▶ button to adjust as desired, keeping in mind that reducing noise (which reduces high frequencies) may also soften the image.



**Overscan:** Some television programs are produced based on the assumption that older television sets may not display the outer edges of the broadcast picture area. Overscan effectively hides these inactive, outer edges of the image. Choose one of the following:

- **Off:** This setting leaves the image as-is.
- **Crop:** This setting adds a mask at the left and right edges of the source active image equal to 3% of the displayed horizontal resolution, and at the top and bottom edges equal to 3% of the displayed vertical resolution.
- **Zoom:** This setting adds a factor to the scaling of the source active image so that the vertical and horizontal resolutions are 106% of the size determined by the aspect ratio function. Anything outside of the original image area is removed.

Figure 4-6 illustrates the effect of each overscan setting for each aspect ratio.

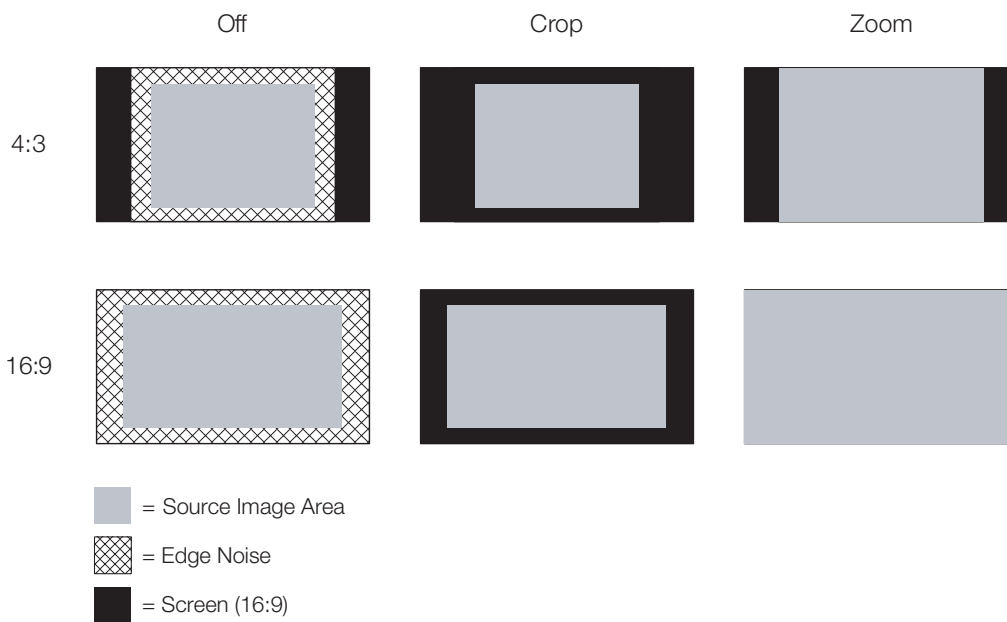

**Figure 4-6. Overscan Examples**

**Input Select:** To select a video source, press ▲ or ▼ to highlight Input Select, then press **ENTER**. This displays the Input Select sub-menu, shown in Figure 4-7.

The default source selection is **HDMI 1**. All sources that are not available per the source enable function (refer to **Input Enable** on page 63) are grayed out.

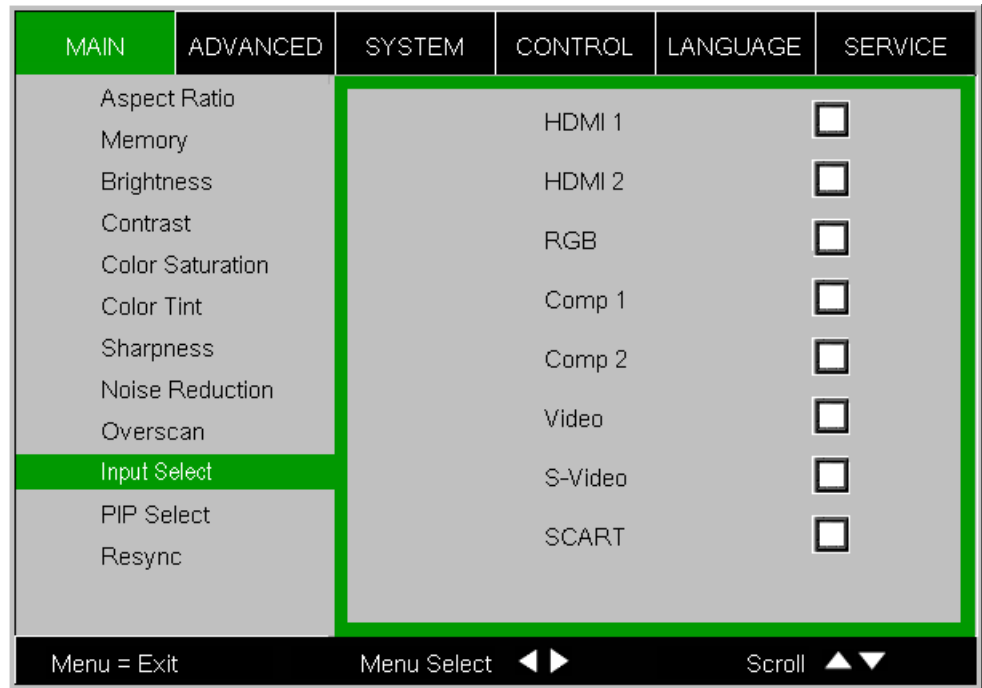

**Figure 4-7. Input Select Sub-Menu**

**PIP Select:** To select a PIP (secondary) video source, press ▲ or ▼ to highlight PIP Select, then press **ENTER**. The default PIP selection is **Off**.

All sources that are not available per the source enable function (refer to **Input Enable** on page 63) are grayed out.

All sources that cannot be used for PIP due to a shared electronic path with the Active source are grayed out. The PIP source is a saved setting for each source, like brightness and contrast.

If for some reason the current PIP source becomes invalid (by disabling it in the source enable menu, for instance), PIP Select automatically resets to **Off**.

**Resync:** If the projected image becomes unstable or degraded, press ▲ or ▼ to highlight Resync, then press **ENTER**. This causes a re-acquisition of the active source and the PIP source, if present. It also changes any Fine Sync settings (described on page page 59) for this timing to the default setting.

Use the controls in the Advanced menu, shown in Figure 4-8, to perform advanced image adjustments.

◀ **Advanced**

MAIN	ADVANCED	SYSTEM	CONTROL	LANGUAGE	SERVICE
Color Space	Auto	REC709	REC601	RGB-PC	RGB-Video
Video Standard	Auto	NTSC	PAL	SECAM	
Gamma	1.8	2.0	2.2	2.35	2.5
Color Temperature	5500K	6500K	7500K	9300K	Native
DLP Frame Rate	Auto	48HZ	50HZ	60HZ	
Color Gamut	Auto	REC709	SMPTE-C	EBU	Native PCE
Constant Contrast	ON		OFF		
Adaptive Contrast	ON		OFF		
RGB Adjust			Enter		
Fine Sync			Enter		
PCE			Enter		

Menu = Exit      Menu Select ◀▶      Scroll ▲▼

**Figure 4-8. LS-10i Advanced Menu**

**Color Space:** Select Color Space from the Advanced menu to choose the color space of the source signal for HDMI, RGB, and component connections.

- The default setting, **Auto**, functions as follows:
  - **HDMI:** If the Auxiliary Video Information (AVI) infoframe contains color space and/or range data, the LS-10i uses that information. Otherwise, for RGB sources, the LS-10i uses the **RGB-Video** color space. For component SDTV and EDTV resolutions, **REC601** is used. For other component video resolutions, **REC709** is used.
  - **RGB:** If Hsync or Vsync signals are present, the LS-10i uses the **RGB-PC** color space. Otherwise, **REC601** is used for SDTV and EDTV sources, and **REC709** for all other sources.
  - **Component:** For SDTV and EDTV resolutions, the LS-10i uses the **REC601** color space. For all other resolutions **REC709** is used.

In most cases, the **Auto** setting determines the correct color space to use. If it does not, you can force the LS-10i to use a specific color space. Choose one of the following:

- **REC709** sets the color space matrix to that defined in ITU-R BT.709.
- **REC601** sets the color space matrix to that defined in ITU-R BT.601.
- **RGB-PC** uses RGB color space and sets black at 0,0,0 RGB and white at 255,255,255 RGB, assuming an 8-bit image.
- **RGB-Video** uses RGB color space and sets black at 16,16,16 RGB and white at 235,235,235, assuming an 8-bit image, to correspond to the luminance values defined in digital component standards.

**Video Standard:** Select Video Standard from the Advanced menu to specify the color system for composite video or S-Video input signals.

Different countries use different formats for video signals. Select the appropriate Video Standard for your region:

- **Auto:** The color systems are automatically identified and the format is set accordingly.
- **PAL:** This is the standard used in Europe, Australia and many other parts of the world, typically with a 50Hz frame rate.
- **SECAM:** This is a standard format used mainly in France and Russia.
- **NTSC:** This is the standard format used mainly in the United States and Japan.

**Gamma:** Select Gamma from the Advanced menu to choose a DLP de-gamma curve. Used correctly, the Gamma control can improve contrast while maintaining good details for blacks and whites.

If excess ambient light washes out the image and it becomes difficult or impossible to see details in dark areas, lower the gamma setting to compensate. This improves contrast while maintaining good details for blacks. Conversely, if the image is washed out and unnatural, with excessive detail in black areas, increase the setting.

- **2.5** sets the gamma to a 2.5 power law.
- **2.35** sets the gamma to a 2.35 power law.
- **2.2** sets the gamma to a 2.2 power law.
- **2.0** sets the gamma to a 2.0 power law.
- **1.8** sets the gamma to a 1.8 power law.

**Color Temperature:** Color temperature defines the “color of gray;” that is, adjusts the 75% white point to various color points.

To choose a color temperature setting, select Color Temperature from the Advanced menu. Then, press ◀ or ▶ to select 5500K, 6500K, 7500K, 9300K or Native. The default setting, 6500K, is appropriate for most situations. Higher settings produce a “bluer” picture; lower ones impart a reddish hue to the image. Select **Native** to disable white point adjustment of the source signal.



**Note**

*The Color Temperature setting is unavailable when you choose the “PCE” Color Gamut setting (refer to **Color Gamut**, below).*

**DLP Frame Rate:** Select DLP Frame Rate from the Advanced menu to choose the output frame rate. You can have the LS-10i automatically determine the optimum frame rate, or you can force it to use a specific frame rate.



**Note**

*If PIP is active, the LS-10i converts the PIP source frame rate to the same frame rate as the main source.*

- The default setting, **Auto**, frame locks to the main source if it has a vertical refresh rate of between 48 and 62Hz. Vertical refresh rates of from 24 to 31Hz are doubled. Frame rates between 31 and 48Hz and greater than 62Hz are converted to 60Hz.
- Select **48Hz** to force the output frame rate to 48Hz. Use this setting to eliminate 2:3 pull-down judder with 60Hz film-based sources.
- **50Hz** and **60Hz** force the output frame rate to 50Hz and 60Hz respectively.

**Color Gamut:** Select Color Gamut from the Advanced menu to select a color gamut (range) that may be different from the default color gamut.

Each setting defines the precise hue of each primary (red, green and blue) and secondary (yellow, cyan and magenta) color component used to generate the millions of colors produced in displays. Changing either or both of these numbers changes the hue of the color and relocates the “triangle” for possible colors. For example, changing the x/y coordinates for red moves the color closer to either orange or violet, which in turn affects all displayed colors having a red component.

- **Auto** automatically chooses the appropriate color gamut:
  - **SMPTE C** for NTSC, 480i and 480p sources.
  - **EBU** for PAL, SECAM, 576i and 576p sources.
  - **REC709** for all other sources.
- **REC709** chooses the REC709 color gamut.
- Select **SMPTE-C** to choose the SMPTE-C color gamut.
- Select **EBU** to choose the EBU color gamut.
- Select **Native** to use REC709 for cyan, magenta, and yellow and uncorrected values for red, green, and blue.
- Select **PCE** to use the Personal Color Equalizer feature of the LS-10i. PCE lets you define a custom color gamut. Refer to **PCE** on page 60 for instructions on how to do this.

Table 4-3 lists the x- and y-coordinates for each primary and secondary color component.

**Table 4-3. x/y Color Gamut Values**

Primary Color	Color Gamut Settings and Associated x/y Values					
	REC709		SMPTE “C”		EBU	
	x	y	x	y	x	y
Red	0.640	0.330	0.635	0.340	0.640	0.330
Yellow	0.419	0.505	0.421	0.506	0.418	0.502
Green	0.300	0.600	0.305	0.595	0.290	0.600
Cyan	0.225	0.329	0.228	0.326	0.220	0.329
Blue	0.150	0.060	0.155	0.070	0.150	0.060
Magenta	0.321	0.154	0.318	0.162	0.328	0.158

**ConstantContrast:** Select ConstantContrast from the Advanced menu to enable (**On**) or disable (**Off**) the ConstantContrast actuator in the optical engine. ConstantContrast uses a dynamic iris that modulates light to the DMD based on the actual content of the video material. Runco recommends that you disable ConstantContrast before adjusting Brightness, Contrast or other image settings.

**Adaptive Contrast:** Adaptive Contrast enhancement expands the light and dark portions of an output image according to the mean luminance of the input image.

**RGB Adjust:** To remove any trace of color from the white areas of the projected image, choose RGB Adjust from the Advanced menu and press **ENTER**. This displays the RGB Adjust sub-menu, shown in Figure 4-9.

MAIN	ADVANCED	SYSTEM	CONTROL	LANGUAGE	SERVICE
	Red Offset			100	
	Green Offset			100	
	Blue Offset			100	
	Red Gain			100	
	Green Gain			100	
	Blue Gain			100	

Menu = Exit      Menu Select ◀▶      Scroll ▲▼

**Figure 4-9. RGB Adjust Sub-Menu**

- **Gain:** Use the Gain controls to correct color imbalances in the bright areas of the image. A good way to do this is to use a test pattern consisting mostly of solid white areas, such as an 80 IRE “window” pattern. If the white areas contain traces of red, green or blue, decrease the Gain for that color.
- **Offset:** Use the Offset controls in the RGB Adjust sub-menu to correct color imbalances in the dark areas of the image. A good way to do this is to use a test pattern consisting mostly of dark gray areas, such as a 30 IRE “window” pattern. If the gray areas contain traces of red, green or blue, decrease the Offset for that color.

The Gain controls increase or decrease the full-scale input range; the Offset controls shift the entire range, resulting in a change in brightness.



**Note**

*Generally, higher Gain settings reduce the image contrast; higher Offset settings reduce the image brightness.*

**Fine Sync:** To fine-tune the position and other image attributes, choose Fine Sync from the Advanced menu and press **ENTER**. This displays the Fine Sync sub-menu, shown in Figure 4-10.

MAIN	ADVANCED	SYSTEM	CONTROL	LANGUAGE	SERVICE
	V Position		100		
	H Position		100		
	Phase		100		
	Tracking		100		
	Sync Level		100		

Menu = Exit      Menu Select ◀▶      Scroll ▲▼

**Figure 4-10. Fine Sync Sub-Menu**

- **V Position:** This control adjusts the vertical position of the image within the designated image area, up to 25 per cent of the image height up or down.
- **H Position:** This control adjusts the horizontal position of the image within the designated image area, up to 25 per cent of the image width left or right.
- **Phase (RGB or Component sources):** This control adjusts the phase of the pixel sampling clock relative to the incoming signal. Adjust the phase when an RGB or Component image still shows shimmer or “noise” after Tracking has been optimized.



**Tip**

*Adjust the Phase **after** adjusting Tracking (see below). If some shimmer from a video or HDTV source persists, use the Noise Reduction controls (described on page 52) to remove high-frequency noise from the signal.*

For best results, use a good test pattern such as a smooth gray consisting of a clear pattern of black and white pixels, or a similar “half on, half off” graphic image. Adjust the slider until the image stabilizes and each pixel is clearly defined. You may notice that you can stabilize the image at more than one point. Use either setting in such cases.

- **Tracking (RGB or Component sources):** Tracking determines the frequency of the pixel sampling clock, indicated by the number of incoming pixels per line, so that all pixels generated by a particular source are sampled.

Steady flickering or several soft vertical stripes or bands across the entire image indicates poor pixel tracking. Proper pixel tracking helps ensure that the image quality is consistent across the screen, that aspect ratio is maintained and that pixel phase (see above) can be optimized.

- **Sync Level (Component sources only):** Select Sync Level to adjust the voltage level of the LS-10i Sync signal detection circuitry.

Sync Level adjustment is occasionally necessary when a DVD player or HDTV source signal drops “below black” (for example, during scenes with explosions or when subtitles are present) and causes the projector to temporarily lose sync. If the Sync Level from the source is persistently too low, the projector won’t sync with the source at all.

The range is from 50 to 256 millivolts (mV) inclusive. The default setting is 240 mV and should rarely require adjustment.

**PCE:** To use the Personal Color Equalizer to define a custom color gamut, choose the “PCE” Color Gamut setting (refer to **Color Gamut** on page 57). Then, choose PCE from the Advanced menu and press **ENTER**. This displays the PCE sub-menu, shown in Figure 4-11.

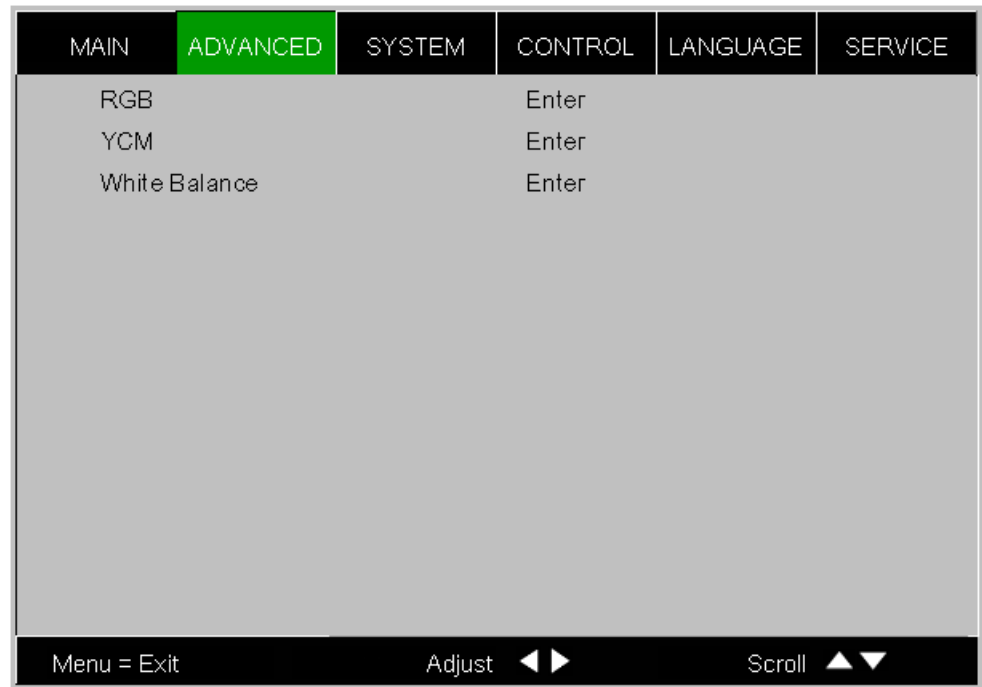
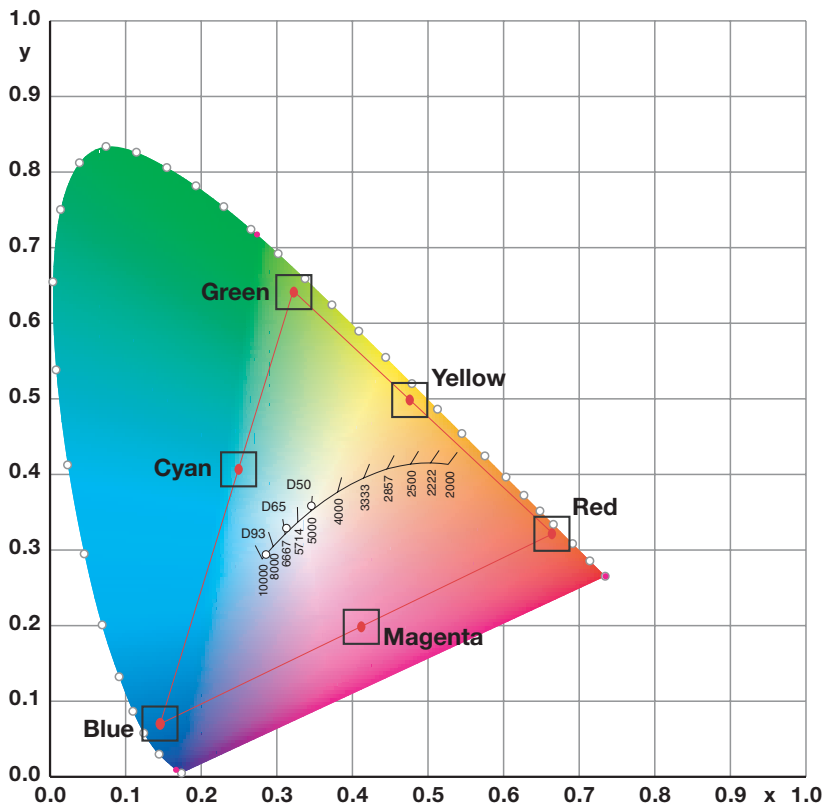

**Figure 4-11. PCE Sub-Menu**



PCE provides the ability to define a custom color gamut in terms of a “white point” and primary (red, green, blue) and secondary (yellow, cyan, magenta) color points.

**What are “color points?”** : A “color point” is an x/y coordinate pair that defines a color’s location on the standard CIE chromaticity graph, shown in Figure 4-12. (CIE stands for “Commission Internationale de l’Éclairage” (International Commission on Illumination), the organization responsible for color measurement and management standards.)



**Figure 4-12. CIE 1931 Chromaticity Diagram**

- **RGB (Red, Green, Blue)/YCM (Yellow, Cyan, Magenta):** To precisely adjust the primary or secondary color points associated with the custom color gamut, choose RGB or YCM respectively from the PCE sub-menu. Each control operates only on the color specified. Surrounding colors are linearly interpolated based on their distance from each of these colors.
- **White Balance:** To precisely adjust the white point associated with the custom color gamut, choose White Balance from the PCE sub-menu. These controls operate identically to the color point controls.

**System** ➤ Use the controls in the System menu, shown in Figure 4-13, to adjust the lamp, change the display orientation and perform other, common installation tasks.

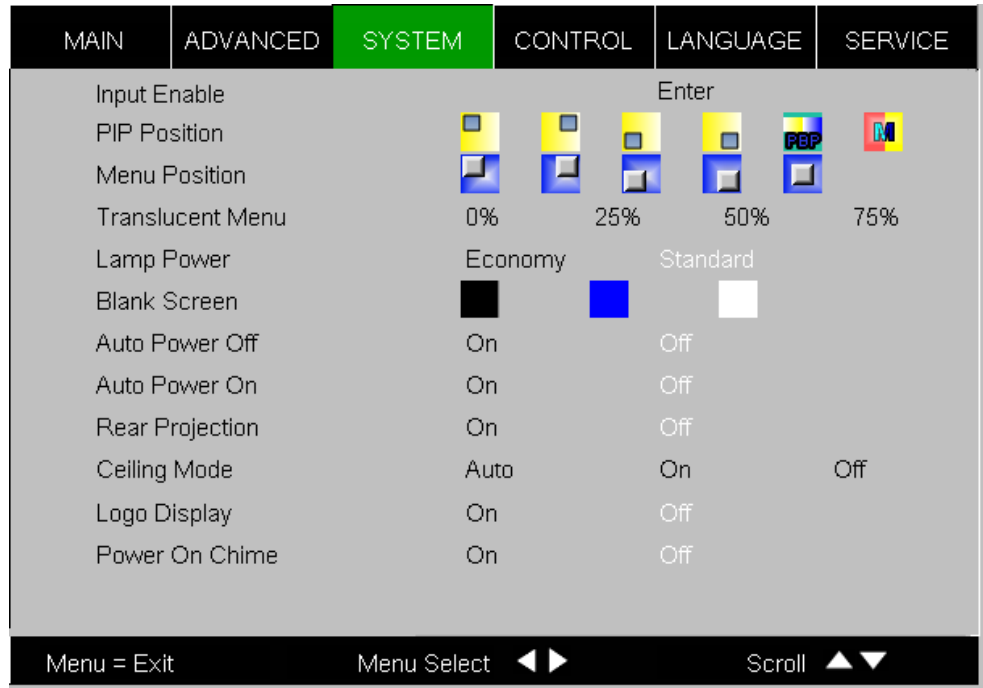

**Figure 4-13. LS-10i System Menu**

**Input Enable:** To enable or disable selection of a source, choose Input Enable from the System menu and press **ENTER**. This displays the Input Enable sub-menu, shown in Figure 4-14.

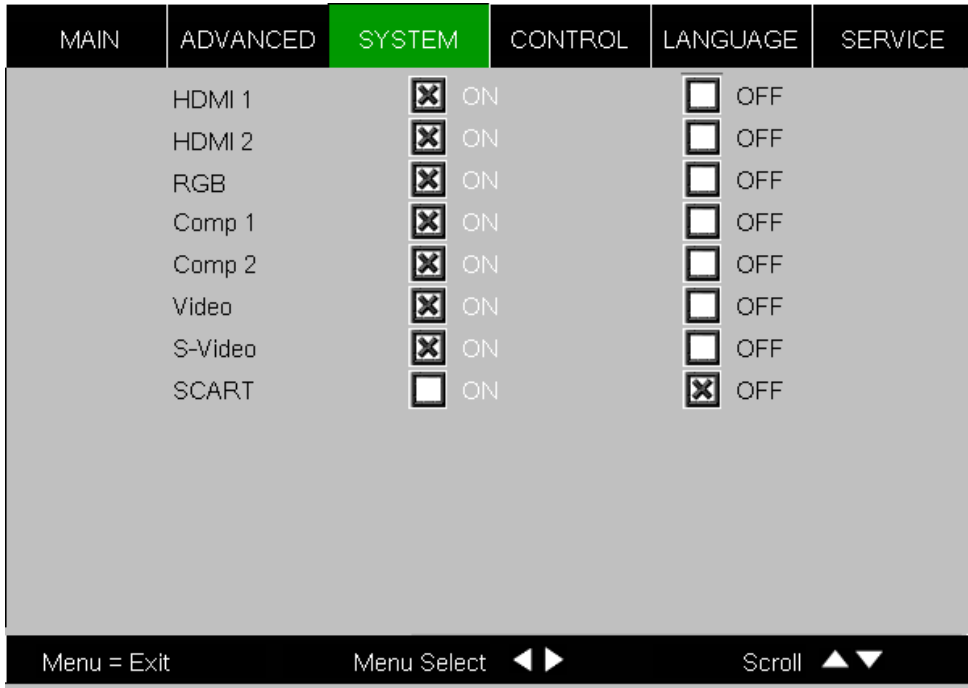

**Figure 4-14. Input Enable Sub-Menu**

- **HDMI 1/HDMI 2:** Enables or disables the HDMI 1 and HDMI 2 sources.
- **RGB:** Enables or disables the RGB source.
- **Comp 1/Comp 2:** Enables or disables the Component 1 and Component 2 sources.
- **Video:** Enables or disables the Composite video source.



**Note**

*If either Component 1 or Video is enabled, SCART must be disabled.*

- **S-Video:** Enables or disables the S-Video source.
- **SCART:** Enables or disables the SCART RGBS source.



**Note**

*If SCART is enabled, both Component 1 and Video must be disabled.*

**PIP Position:** To change the position of the PIP image, choose PIP Position from the System menu; see Figure 4-15. Choose one of the following:

- **Top Left:** This places the PIP source into a 644x362 designated image area at the top left of the screen.
- **Top Right:** This places the PIP source into a 644x362 designated image area at the top right of the screen.
- **Bottom Left:** This places the PIP source into a 644x362 designated image area at the bottom left of the screen-safe area of the DMD.
- **Bottom Right:** This places the PIP source into a 644x362 designated image area at the bottom right of the screen-safe area of the DMD.
- **Picture-By-Picture:** This reduces the designated image area of the Active source to 921x518 and places it next to the PIP source, which is also in a 921x518 image area. These two images are centered on the screen.
- **Split Screen:** This is a special mode in which the active source is also used as the PIP source and placed in a PIP area equal to half the display on the left side. This results in the right half of the image being the active source and the left half is the PIP source. The LS-10i applies the **Custom 2** settings to the PIP image.

Split-screen mode is useful for viewing “before” and “after” settings for Sharpness, Noise Reduction and other advanced image parameters. See Figure 4-16.

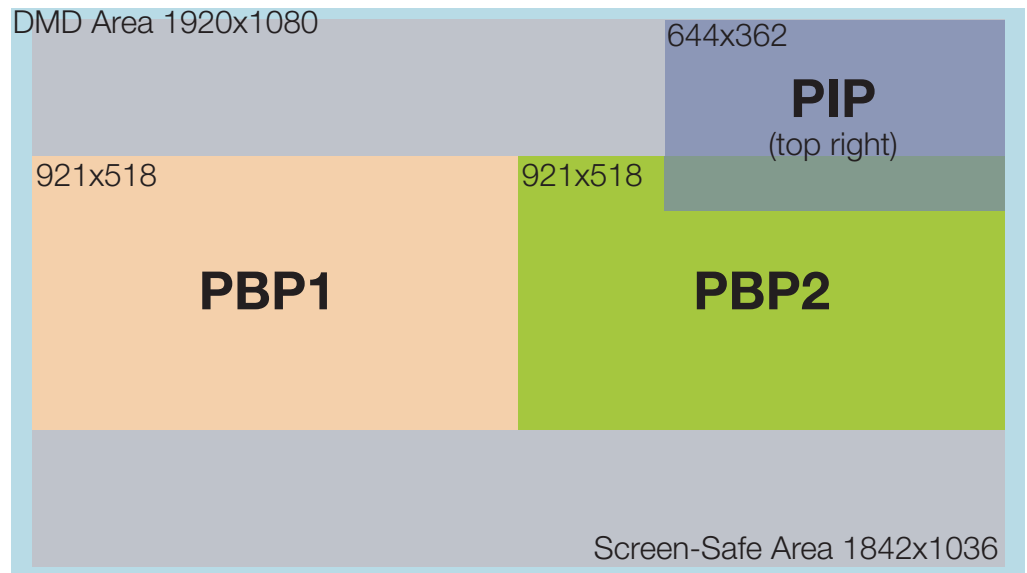

**Figure 4-15. PIP and PBP areas for 1080p Display**

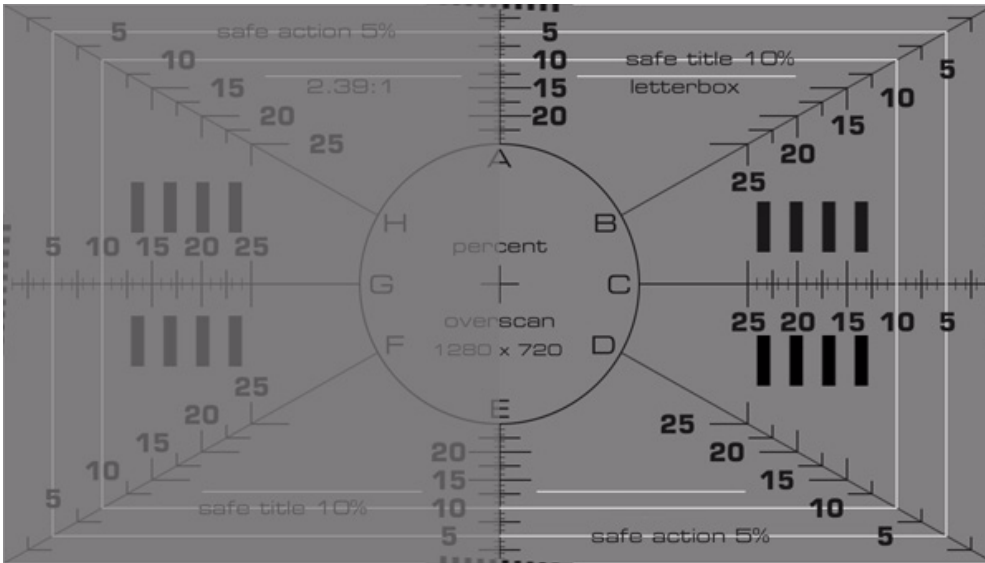

**Figure 4-16. PIP Split-Screen Mode**

**Menu Position:** Select Menu Position from the System menu to change the OSD menu position. The default setting is "A" (top left).

**Translucent Menu:** Select Translucent Menu from the System menu to adjust the degree of translucence (show-through) in the menus and message boxes. 0% means that the menus are opaque. The default setting is 25%.

**Lamp Power:** Select Lamp Power from the System menu to adjust the lamp output level. You can choose to run the lamp as bright as possible (260W; this is the default setting) or you can choose the **Economy** (230W) setting. Generally, lower lamp output prolongs the life of the lamp, but decreases brightness. This setting is per source, not global, so it can be saved like other user settings.

**Blank Screen:** Select Blank Screen from the System menu to choose the color of the blank screen that appears when no source signal is present. The options are **Black**, **Blue** and **White**. The default is **Black**.

**Auto Power Off:** Set Auto Power Off to **On** to have the LS-10i turn itself off after 20 minutes of inactivity (no source signal present).

**Auto Power On:** Setting Auto Power On to **On** causes the projector to automatically power up when AC power is present. If the projector is plugged into a switched AC outlet, this allows the projector to be turned on using a wall switch instead of the remote control unit. If you do not need this capability, set Auto Power On to **Off** (this is the default).

**Rear Projection:** This control reverses all images and menus, and is necessary when the projector is used in rear-projection applications. The default is **Off**.

**Ceiling Mode:** This control flips the image so the projector can be used in ceiling mounted installations. The default setting, **Auto**, automatically determines the orientation using an internal sensor.

**Logo Display:** This controls whether or not the Runco logo appears during startup.

**Power On Chime:** This controls the audible chime at startup.

**Control** ➤ Select Control from the Main Menu to set various options related to control of the projector.

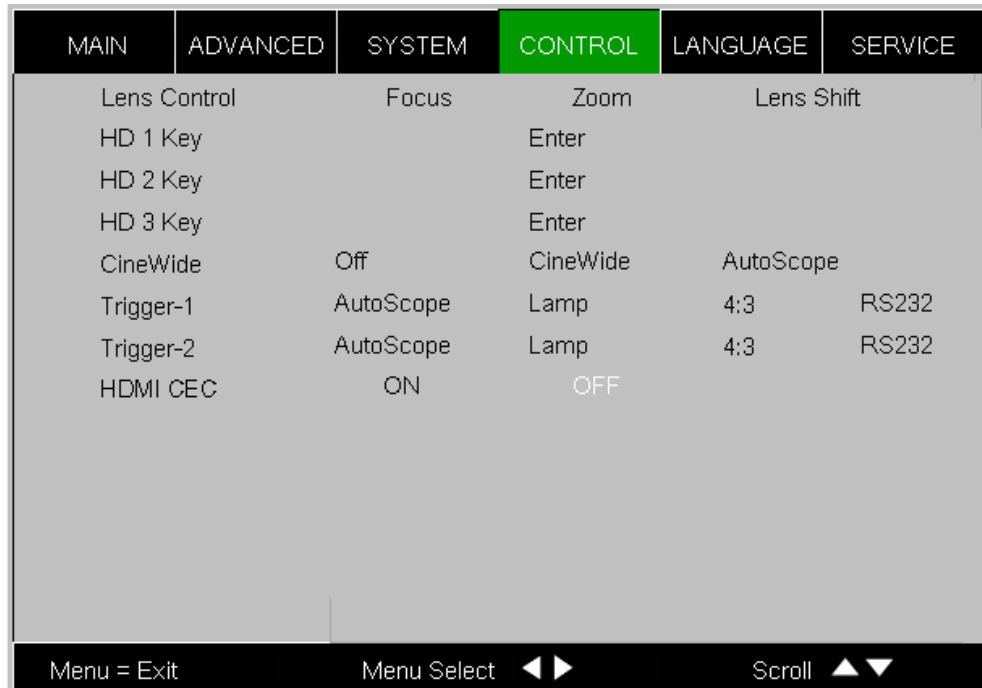

**Figure 4-17. LS-10i Control Menu**

**Lens Control:** Select Lens Control from the Control menu to perform lens adjustments (focus, zoom and lens shift). For detailed instructions, refer to **Primary Lens Adjustments** on page 38.

**HD 1 Key / HD 2 Key / HD 3 Key:** These menu items assign the function of the HD 1, HD 2 and HD 3 buttons on the remote.

There are eight sources corresponding to the eight connections to the projector. When you assign a source to the HD 1, HD 2 or HD 3 button, the projector immediately goes to that source when the button is pressed.

If the chosen source is disabled via the Input Enable menu (refer to page 63), this setting has no effect.

You can also assign one or more of these buttons to the PIP function. When you do, the projector switches to the next available “PIP Select” state each time the button is pressed. Refer to **PIP Select** on page 54 for more information.

**CineWide:** Select CineWide from the Control menu and set it according to the installed lens configuration, as follows:

- For a standard LS-10i (no anamorphic lens), choose **Off**.
- For an LS-10i with a fixed anamorphic lens, choose **CineWide**.
- For an LS-10i with a motorized anamorphic lens, choose **AutoScope**.

**Trigger 1:** Select Trigger 1 from the Control menu to specify when the Trigger 1 port outputs 12 volts. There is a three-second delay before activation to prevent operation while selecting an aspect ratio.

- **AutoScope** causes the port to output 12 volts whenever the the Cinema or Virtual Cinema aspect ratio is active.
- **Lamp** causes the port to output 12 volts whenever the lamp (LED RGB assembly) is on.
- **4:3** causes the port to output 12 volts whenever the 4:3 aspect ratio is chosen. The output stops if PIP is enabled (PIP source is set to anything other than off).
- **RS232** causes the port to output 12 volts when an RS232 screen trigger 1 “on” command is received and stop when a trigger 1 “off” command is received. The 12 volt output also stops when the projector is turned off.

**Trigger 2:** Select Trigger 2 from the Control menu to configure the Trigger 2 output. Trigger 2 operates identically to Trigger 1.

**HDMI CEC:** This control chooses whether or not the LS-10i responds to HDMI CEC control messages from a disc player, set-top box or other HDMI source. The default setting is **On**. For more information about CEC, refer to **Using HDMI CEC Messages** on page 87.

Select Language from the Main Menu to change the OSD Language.

◀ **Language**

The LS-10i can display the menus in English, French, German, Italian, Spanish, Swedish, Portuguese or Russian.

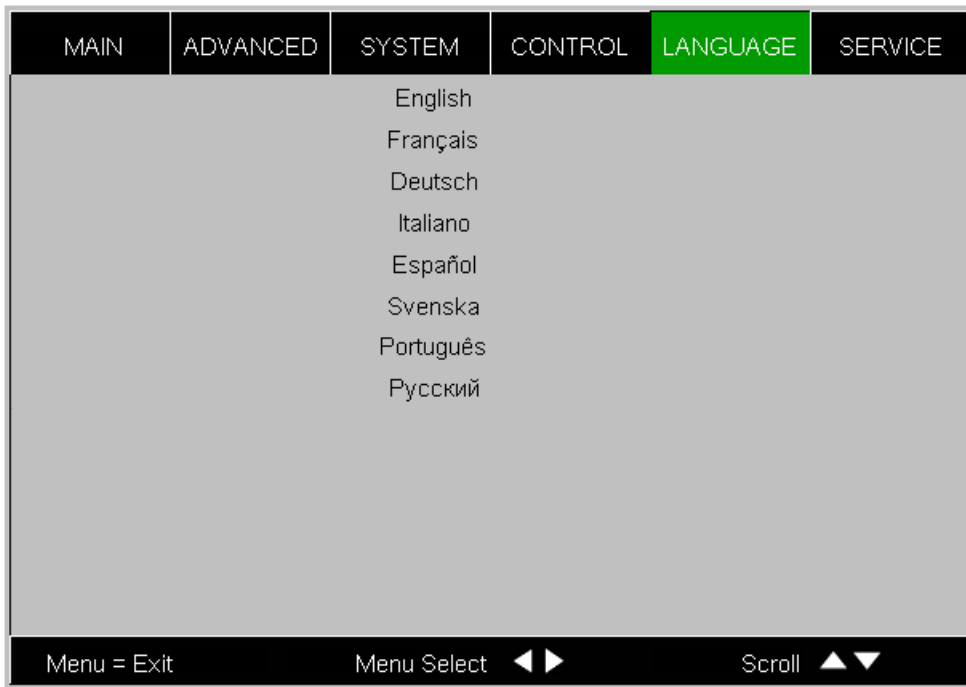

Press ▲ or ▼ to select a language. Then, press **ENTER** to confirm your selection.

**Service** ➤ Access the Service Menu, shown in Figure 4-18, to view information that uniquely identifies your projector and indicates its current operational status:

- Model Name
- Unit Serial Number
- Software Version
- Active/PIP Source
- Pixel Clock
- Signal Format
- H/V Refresh Rate
- Lamp Hours (number of lamp hours elapsed since the last reset)

Should you ever need to contact Runco Technical Support, this information will help them answer your questions and/or resolve product performance issues.

MAIN	ADVANCED	SYSTEM	CONTROL	LANGUAGE	SERVICE
MODEL NAME :			LS-10i		
Serial Number :			SN-12345678900000		
Software Version :			HT8610PXCA-MMD01.1109		
Active/PIP source :			HDMI 1 / OFF		
Pixel Clock :			148.5MHZ		
Signal Format :			1080P		
H/V Refresh Rate :			H:67.5KHZ, V:60.00HZ		
Lamp Hours :			999999999HR		
Lamp Hour Reset			Enter		
Factory Reset			Enter		
Blue Only			ON	OFF	
Test Patterns			ON	OFF	
Altitude			Auto	High	
Menu = Exit		Menu Select ◀▶		Scroll ▲▼	

**Figure 4-18. LS-10i Service Menu**

You can also perform various maintenance tasks, such as resetting the lamp hour counter, from this menu.



**Lamp Hour Reset:** When you replace the projector lamp (refer to **Lamp Replacement** on page 71), you should also reset the lamp hour counter. To do this, select Lamp Hour Reset from the Service menu, then press **ENTER**. Press **ENTER** again to confirm the reset. Or, to cancel the operation, press ► on the remote to highlight **No**, then press **ENTER**.

**Note**

*Reset the Lamp Hour counter ONLY after you replace the lamp. Otherwise, the reported “Lamp Hours” will be inaccurate.*

**WARNING**

*Do not exceed the recommended lamp life. An old lamp becomes increasingly fragile and prone to sudden failure.*

**Factory Reset:** Select Factory Reset from the Service menu to restore all projector settings – except those listed below – to their factory-default values:

- Lamp Hours
- Custom 1 / Custom 2
- ISF Day
- ISF Night
- Model Name / Serial Number
- Language

**Blue Only:** This feature removes all red and green color information from the image, and is useful for color-calibrating the projector or other video components.

**Test Patterns:** The LS-10i has numerous internal test patterns that are useful to technicians for advanced calibration, measurement and fault isolation purposes. To access them, select Test Patterns from the Service menu and set it to **On**.

The available test patterns are:

- White
- Black
- Red
- Green
- Blue
- Cyan
- Magenta
- Yellow
- ANSI Checkerboard
- Horizontal Gray Ramp
- Focus Grid

Press ◀ or ▶ on the remote control unit or built-in keypad to cycle through the test patterns.

**Note**

*The OSD menus are not available when in “test pattern” mode.*

To turn test patterns off, press any key other than ◀ or ▶ on the remote control unit or built-in keypad.

**Altitude:** Select Altitude from the Service Menu to control the operation of the projector's cooling fan.

In most cases, the default setting (**Auto**) will maintain the correct operating temperature. If the lamp frequently turns off due to overheating, or in certain high-altitude operating environments, you may need to change this setting to **High**.

## 5. Maintenance and Troubleshooting

The lamp should be replaced when it reaches the end of its life (typically between 2000 and 4000 hours depending on the Lamp Power setting), or sooner if a noticeable degradation in brightness occurs. Contact your Runco dealer to obtain a replacement lamp.

### 5.1 Lamp Replacement

1. Turn off the projector and unplug the power cord. **Allow the projector to cool down for approximately 60 minutes prior to removing the lamp assembly for replacement.**

2. Using a flat-blade screwdriver, loosen the two screws holding the rear compartment cover in place.

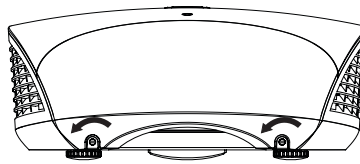

3. Remove the rear compartment cover by tilting it upward.

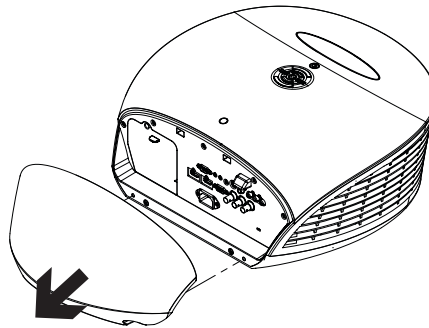

4. Loosen the screw on the lamp cover and pull the lamp cover out.

5. Loosen the two screws on the lamp module.

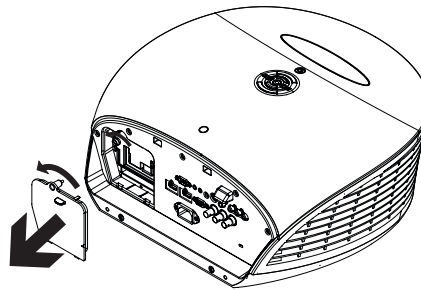

6. Pull the lamp module handle firmly to remove the lamp module.
7. Perform Steps 6 through 2 (in reverse order) to install the new lamp module.
8. Turn on the power and reset the lamp timer (refer to **Lamp Hour Reset** on page 69).

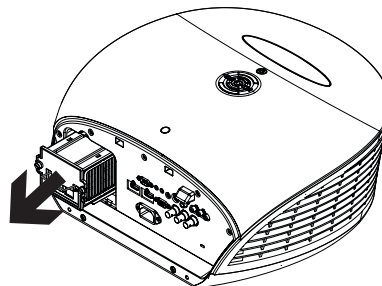

## 5.2 Troubleshooting Tips

Table 5-1 provides some general guidelines for troubleshooting problems you may encounter with the LS-10i. If the suggested solutions fail to resolve the problem or if you encounter an issue not described here, please contact Runco Technical Support.

**Table 5-1. Troubleshooting Chart**

Symptom	Possible Cause(s)	Solution
The projector does not turn on.	<ul style="list-style-type: none"> <li>The LS-10i is not plugged in or the AC outlet is not active.</li> <li>Lamp cover is not securely attached.</li> </ul>	<ul style="list-style-type: none"> <li>Ensure that the LS-10i is plugged in and that the AC outlet is active.</li> <li>Securely attach the lamp cover.</li> </ul>
The projector does not turn back on after it was powered off.	<ul style="list-style-type: none"> <li>The projector will not turn on for two minutes after power-off, to protect the lamp.</li> </ul>	<ul style="list-style-type: none"> <li>Wait until the LS-10i completes its cool-down (POWER LED lights solid green).</li> </ul>
The remote control does not work correctly.	<ul style="list-style-type: none"> <li>The batteries have run out.</li> </ul>	<ul style="list-style-type: none"> <li>Replace the batteries.</li> </ul>
The projector is on and OSD menus appear, but there is no video image on-screen.	<ul style="list-style-type: none"> <li>Incorrect source selection.</li> <li>Source component is not turned on.</li> <li>Source component is connected incorrectly or not at all.</li> </ul>	<ul style="list-style-type: none"> <li>Select the correct source.</li> <li>Turn on the source.</li> <li>Check cable connection from source component to projector.</li> </ul>
A projected image from a DVD is split or otherwise scrambled.	<ul style="list-style-type: none"> <li>DVD player is connected to the Component input and set to progressive scan mode.</li> </ul>	<ul style="list-style-type: none"> <li>Turn off progressive scan on the DVD player.</li> </ul>
Image is blurred.	<ul style="list-style-type: none"> <li>The lens is not correctly focused.</li> </ul>	<ul style="list-style-type: none"> <li>Adjust the focus.</li> </ul>
Image geometry is incorrect.	<ul style="list-style-type: none"> <li>Incorrect aspect ratio selection.</li> </ul>	<ul style="list-style-type: none"> <li>Select the aspect ratio that best matches the source image and screen size (refer to Table 4-2).</li> </ul>
Images from an HDMI source do not display.	<ul style="list-style-type: none"> <li>The resolution and frequency of the video card in the computer are not compatible with the LS-10i.</li> <li>HDMI cable from source to LS-10i is either defective or too long.</li> </ul>	<ul style="list-style-type: none"> <li>Select a compatible resolution and vertical frequency (refer to <b>Supported Timings</b> on page 93).</li> <li>Try a known-good and/or shorter HDMI cable.</li> </ul>
Image is too bright and/or lacks definition in the bright areas of the image.	<ul style="list-style-type: none"> <li>Contrast is set too high.</li> </ul>	<ul style="list-style-type: none"> <li>Lower the contrast setting.</li> </ul>

**Note:** You can obtain more detailed information about the cause of the error condition using RS-232 commands. Refer to **RS-232 Error Codes** on page 86 for more information.

**Table 5-1. Troubleshooting Chart (continued)**

Symptom	Possible Cause(s)	Solution
Image appears “washed out” and/or dark areas appear too bright.	<ul style="list-style-type: none"> <li>Brightness is set too high.</li> </ul>	<ul style="list-style-type: none"> <li>Lower the brightness setting.</li> </ul>
Colors in the image are swapped; for example, reds appear blue or vice versa.	<ul style="list-style-type: none"> <li>The Red/Pr, Green/Y or Blue/Pb outputs from the source are connected to the wrong inputs on the LS-10i.</li> </ul>	<ul style="list-style-type: none"> <li>Ensure that the source outputs are connected to the correct LS-10i input.</li> </ul>
LED is flashing alternating green and red.	<ul style="list-style-type: none"> <li>The lamp cover is open.</li> <li>The lamp has failed or exceeded its usage life.</li> </ul>	<ul style="list-style-type: none"> <li>Close the lamp cover.</li> <li>Replace the lamp with a new one.</li> </ul>
LED is flashing red.	<ul style="list-style-type: none"> <li>LS-10i internal temperature is too high.</li> </ul>	<ul style="list-style-type: none"> <li>Power off the LS-10i and allow it to cool down. Ensure that the intake and exhaust vents are not blocked. Turn the projector back on. If the problem persists, please contact Runco Technical Support for assistance.</li> </ul>
LED lights solid red.	<ul style="list-style-type: none"> <li>Fans are not working properly or power-on self-test has failed (Note).</li> </ul>	<ul style="list-style-type: none"> <li>Please contact Runco Technical Support for assistance.</li> </ul>
<p><b>Note:</b> You can obtain more detailed information about the cause of the error condition using RS-232 commands. Refer to <b>RS-232 Error Codes</b> on page 86 for more information.</p>		

**Notes:**

## 6. External Control

In addition to using the LS-10i remote control unit, there are three methods of controlling the projector externally:

- Using a serial (RS-232) link to send ASCII commands and receive responses to those commands.
- Using discrete infrared (IR) codes to program a third-party remote control unit.
- Using an HDMI connection to send Consumer Electronics Control (CEC) commands from a BD player or other source component that supports CEC.

The following sections describe these methods.

The LS-10i uses a simple text-based control protocol to take requests from control devices and to provide responses to such devices. This section describes how to send control messages over a serial link between the LS-10i and an automation/control system or a PC running terminal emulation software.

To interface the LS-10i with a home theater automation/control system or a PC running terminal emulation software:

1. Connect it to your control system or PC as shown in Figure 3-13.
2. Start a terminal session on your PC using a terminal-emulation program, such as HyperTerminal.
3. Configure the RS-232 controller or PC serial port as follows: 38400 bps, no parity, 8 data bits, 1 stop bit and no flow control.
4. Type **ky** or **op** followed by a command from among those listed in Table 6-1 or Table 6-2 and press **<Enter>**. For example, to change the aspect ratio to Letterbox, type `op aspect = 1<Enter>`.

Serial commands to the LS-10i take the following form:

- Commands are in ASCII format.
- Spaces and tabs can be used to improve readability and are ignored by the projector.
- All commands must end with a carriage return (ASCII hex 0D) to signify that the projector can now read and execute the command.
- Commands are not case-sensitive.

The LS-10i supports two types of commands: key commands and operation commands. Key commands mimic pressing a button on the remote control. Operation commands tell the projector exactly what to do.

All commands start with 2 letters:

**ky** for key commands.

**op** for operations commands.

### 6.1 Serial Communications

#### ◀ RS-232 Connection and Port Configuration

#### ◀ Serial Command Syntax

**Key Commands:** The syntax for key commands is simple:

**ky <keyname>[CR]**

Some key command examples:

**ky menu [CR]** Bring up or cancel menu display.

**ky mem.sw [CR]** Switch to next user memory.

**ky asp.16.9 [CR]** Apply 16:9 aspect ratio.













The response from the projector for key commands will be the same command in UPPERCASE.

Input: **ky mem.sw [CR]**

Response: **KY MEM.SW [CR]**













Table 6-1 lists the serial command key names and IR codes. Use the IR codes to program a third-party remote control unit.

**Table 6-1. Serial Command Key Names and IR Codes**















IR Code	RS232 Keyname	Remote Button	Description
0x00	pow.on		Turn power on. If the projector is already on, this toggles the input panel backlight.
0x45	pow.off		Turn power off.
0x02	src.video		Switch the active source to Video.
0x1f	src.svid		Switch the active source to S-Video.
0x0a	src.hdmi1		Switch the active source to HDMI 1.
0x50	src.hdmi2		Switch the active source to HDMI 2.
0x1e	src.1		Perform action assigned by user to HD 1 button (switch active source or change PIP state).
0x40	src.2		Perform action assigned by user to HD 2 button (switch active source or change PIP state).
0x58	src.3		Perform action assigned by user to HD 3 button (switch active source or change PIP state).
0x1b	info		Bring up an information box with the first seven (7) items in the Service menu.
0x19	menu		Bring up or cancel menu display.
0x5c	exit		Exit all menus.
0x51	enter		Keypad enter. If PIP is active and no menu is present then this executes the PIP swap function.



**Table 6-1. Serial Command Key Names and IR Codes (continued)**

IR Code	RS232 Keyname	Remote Button	Description
0x1d	cur.down		Keypad down arrow.
0x44	cur.up		Keypad up arrow.
0x1c	cur.left		Keypad left arrow.
0x48	cur.righ		Keypad right arrow.
0x06	bright		Bring up or cancel brightness slider.
0x05	contrast		Bring up or cancel contrast slider.
0x04	color		Bring up or cancel color slider.
0x03	tint		Bring up or cancel tint slider.
0x5f	isf.nigh		Changes to ISF Night preset.
0x07	isf.day		Changes to ISF Day preset.
0x4b	mem.1		Changes to Custom 1 preset.
0x4a	mem.2		Changes to Custom 2 preset.
0x42	asp.16.9		Apply 16:9 aspect ratio to the active source.
0x46	asp.4.3		Apply 4:3 aspect ratio to the active source.
0x52	asp.lett		Apply Letterbox aspect ratio to the active source.
0x43	asp.vwide		Apply VirtualWide aspect ratio to the active source.
0x01	asp.cin		Apply Cinema aspect ratio to the active source.
0x47	asp.vcin		Apply VirtualCinema aspect ratio to the active source.

**Table 6-1. Serial Command Key Names and IR Codes (continued)**

IR Code	RS232 Keyname	Remote Button	Description
0x08	1		Used to enter numeric characters.
0x0c	2		
0x0d	3		
0x0e	4		
0x0f	5		
0x14	6		
0x15	7		
0x16	8		
0x17	9		
0x18	0		
0x12	focus		Bring up or cancel focus menu.
0x10	zoom		Bring up or cancel zoom menu.
0x13	shift		Bring up or cancel lens shift menu.
(none)	(none)		Activates remote backlighting when pressed.

**Operations Commands:** Operations commands allow more flexible and direct control of the projector. The syntax for operations commands is as follows:

**op <operation> <command>[CR]**

(Precede <operation> and <command> with a space.)

The command type can be one of 5 functions:

Operations Control Commands		
Function	Command	Action on unit
Set	= <value>	Makes the unit take that value.
Get	?	Asks what the current value is.
Increment	+	Adds 1 to the current value.
Decrement	-	Subtracts 1 from the current value.
Execute	(none)	Performs an action such as a reset.

Table 6-2 lists the valid operations commands. For all but Execute functions, the response from the projector is the command and “= <value>” where <value> is the current value or “NA” if the value is not available. For Execute functions the response is the same command. All responses are in UPPERCASE.

Some operations command examples:

Input: **op bright ? [CR]**

Response: **OP BRIGHT = 100 [CR]**

Input: **op bright + [CR]**

Response: **OP BRIGHT = 101 [CR]**

Input: **op bright = 127 [CR]**

Response: **OP BRIGHT = 127 [CR]**

Input: **op bright - [CR]**

Response: **OP BRIGHT = 126 [CR]**

Input: **op resync [CR]**

Response: **OP RESYNC [CR]**

Input: **op sharp.mode = 1 [CR]**

Response: **OP SHARP.MODE = 1 [CR]**

Input: **op sharp.simple = 50 [CR]**

Response: **OP SHARP.SIMPLE = NA [CR]**

Input: **op sharp.simple ? [CR]**

Response: **OP SHARP.SIMPLE = NA [CR]**

The last three commands show what happens when a control is grayed out. In this case, the sharpness mode was set to advanced (value = 1) and then the simple sharpness slider was attempted to be adjusted and queried. The response was “NA” or not available.

**Table 6-2. Serial Commands**

Operation	Commands	Values	Notes
aspect	= ?	0 = 16:9 1 = Letterbox 2 = 4:3 3 = VirtualWide 4 = Cinema 5 = VirtualCinema	
memory	= ?	0 = Custom 1 1 = Custom 2 2 = ISF Day 3 = ISF Night 4 = Default	? only returns a value if ISF Day or ISF Night is active, otherwise it returns NA
save.mem	=	0 = Custom 1 1 = Custom 2	
save.isf	=	0 = ISF Day 1 = ISF Night	
bright contrast saturat tint sharp nr	= ? + -	0 - 200	
overscan	= ?	0 = Off 1 = Crop 2 = Zoom	
source.sel	= ?	0 = HDMI 1 1 = HDMI 2 2 = RGB 3 = YPrPb 1 4 = YPrPb 2 5 = S-Video 6 = Video 7 = SCART	
pip.select	= ?	0 = Off 1 = HDMI 1 2 = HDMI 2 3 = RGB 4 = YPrPb 1 5 = YPrPb 2 6 = S-Video 7 = Video 8 = SCART	
resync	(execute)		

**Table 6-2. Serial Commands (continued)**

Operation	Commands	Values	Notes
color.space	= ?	0 = Auto 1 = REC709 2 = REC601 3 = RGB-PC 4 = RGB-Video	
video.stand	= ?	0 = Auto 1 = NTSC 2 = PAL 3 = SECAM	
gamma	= ?	0 = 1.8 1 = 2.0 2 = 2.2 3 = 2.35 4 = 2.5	
color.temp	= ?	0 = 5500K 1 = 6500K 2 = 7500K 3 = 9300K	
dlp.frame	= ?	0 = Auto 2 = 48 Hz 3 = 50 Hz 4 = 60 Hz	
color.gamut	= ?	0 = Auto 1 = REC709 2 = SMPTE C 3 = EBU 4 = Native 6 = PCE (custom)	
ccont	= ?	0 = Off 1 = On	
focus	+ -		
zoom	+ -		
vert.offset	+ -		Vertical lens shift
horiz.offset	+ -		Horizontal lens shift
shift.reset	(execute)		Returns lens to "zero offset" position
red.off green.off blue.off	= ? + -	0-200	Red/Green/Blue Offset
red.gain green.gain blue.gain	= ? + -	0-200	Red/Green/Blue Gain

**Table 6-2. Serial Commands (continued)**

Operation	Commands	Values	Notes
vert.pos horiz.pos phase tracking sync.level	= ? + -	0-200	Fine Sync menu settings
pip.pos	= ?	0 = Top left 1 = Top right 2 = Bottom left 3 = Bottom right 4 = Picture by picture 5 = Split screen	
lamp.pow	= ?	0 = Economy 1 = Standard	
menu.pos	= ?	0 = Top left 1 = Top right 2 = Bottom left 3 = Bottom right 4 = Center	
trans.menu	= ?	0 = 0% 1 = 25% 2 = 50% 3 = 75%	
blank.screen	= ?	0 = Black 1 = Blue 2 = White 3 = Logo	
auto.pow.off	= ?	0 = Off 1 = On	
auto.pow.on	= ?	0 = Off 1 = On	
rear.proj	= ?	0 = Off 1 = On	
ceil.mode	= ?	0 = Off 1 = On 2 = Auto	
logo.disp	= ?	0 = Off 1 = On	
power.chime	= ?	0 = Off 1 = On	

**Table 6-2. Serial Commands (continued)**

Operation	Commands	Values	Notes
1.key 2.key 3.key	= ?	0 = HDMI 1 1 = HDMI 2 2 = RGB 3 = YPrPb 1 4 = YPrPb 2 5 = S-video 6 = Video 7 = SCART	HD 1/HD 2/HD 3 key source assignments.
trig.1 trig.2	= ?	0 = Lamp 3 = 4:3 4 = AutoScope 5 = RS232 6 = On 7 = Off	
model.name	?	<string>	
ser.number	?	<string>	
soft.version	?	<string>	
act.source pip.source	?	0 = HDMI 1 1 = HDMI 2 2 = RGB 3 = Component 1 4 = Component 2 5 = S-video 6 = Video 7 = SCART	
h.refresh	?	<number>	kHz
v.refresh	?	<number>	Hz
pixel.clock	?	<number>	MHz
signal	?	<string>	
lamp.hours	?	<number>	
total.hours	?	<number>	
environment	?	<string>	temperatures
lamp.reset	(execute)		
fact.reset	(execute)		
blue.only	=	0 = Off 1 = On	

**Table 6-2. Serial Commands (continued)**

Operation	Commands	Values	Notes
pattern	=	0 = White 1 = Black 2 = Red 3 = Green 4 = Blue 5 = Cyan 6 = Magenta 7 = Yellow 8 = ANSI Checkerboard 9 = Horizontal Gray Ramp 10 = Focus Grid 11 = Off	
language	= ?	0 = English 1 = French 2 = German 3 = Italian 4 = Spanish 5 = Swedish 10 = Portuguese 11 = Russian	OSD language only
cinewide	= ?	0 = Off 1 = CineWide 2 = AutoScope	
altitude	= ?	0 = auto 1 = high	
pce.rx pce.ry pce.gx pce.gy pce.bx pce.by pce.yx pce.yy pce.cx pce.cy pce.mx pce.my pce.wx pce.wy	= ? + -	0-200	Personal Color Equalizer (PCE) color point and white point settings.
status	?	0 = Standby 1 = Powering Up 2 = Displaying 3 = Cooling Down 4 = Error	
errcode	?	Refer to <b>RS-232 Error Codes</b> , below.	



**Table 6-2. Serial Commands (continued)**

Operation	Commands	Values	Notes
msgbox	= ?	0 = On 1 = Off	This control enables or disables the display of power off, source and adjustment message boxes (brightness, contrast etc.). Default value is ON.
cal.text1 cal.text2 cal.text3	=	Up to 30 characters.	The LS-10i start-up screen is customizable with three lines of text of up to 30 characters each. This text appears below the "CALIBRATED FOR:" text in the logo screen. The allowable characters are all numbers, letters (uppercase and lowercase), spaces, and symbols available in the ASCII code set.

**RS-232 Error Codes** ➤ If an `errcode ?` command returns one of the following values, you have encountered a likely system error requiring the attention of a qualified service technician. Try resetting the projector by powering it off, allowing it to cool and powering it on again. Refer to Table 6-3 and contact your dealer if the problem persists.

The specific code number identifies the source of the error detected, and is particularly useful in cases where the projector is far away. For example, the code “7” means that Fan 1 has failed.

**Table 6-3. RS-232 Error Codes**

Error Code	LED Indication	Description
0		Inlet NTC thermal sensor is over temperature.
1		DMD NTC thermal sensor is over temperature.
2		Lamp 1 over temperature.
4		Ballast 1 over temperature.
6		Fan failure upon system power-up.
7		Fan 1 failed.
8		Fan 2 failed.
9		Fan 3 failed.
10		Fan 4 failed.
11		Fan 5 failed.
12		Fan 6 failed.
13		Fan 7 failed.
14		Fan 8 failed.
15		DDP3021 communication failure upon system power-up.
16		Lamp failed to ignite (three attempts) upon system power-up.
17		Lamp failed during operation.
18		Ballast UART communication failure.
19		PCF8575 external GPIO communication failure.
20		Lamp door is open.
21		Gennum SPI communication failure upon system power-up.
22		System hardware I2C communication failure.
23		System software I2C communication failure.
24		EEPROM checksum error.
25		EDID checksum error.

The LS-10i accepts and can respond to CEC command messages from a disc player, satellite receiver or DVR/set-top box via an HDMI connection. Using CEC, the LS-10i can perform the following actions:

- Turn itself on and select the correct input when the source component initiates playback of a disc or recorded program.
- Turn the source component on when you switch to its corresponding input on the LS-10i.
- Turn the source component off when the LS-10i is turned off (unless the source component is in playback mode).
- Change its OSD language when a similar change is made at the source.

To use CEC, connect your CEC-compatible sources to the HDMI inputs on the LS-10i. Set the HDMI CEC option to **On** (refer to **HDMI CEC** on page 67). Additional steps may be needed to enable CEC at the source. Refer to the documentation for your source device for more information.

Table 6-4 lists the CEC commands supported by the LS-10i.

**Table 6-4. CEC Commands Supported by the LS-10i**

Opcode	Value
Feature Abort	0x00
Image View On	0x04
Set Menu Language	0x32
Standby	0x36
User Control Pressed	0x44
User Control Released	0x45
Active Source	0x82
Give Physical Address	0x83
Report Physical Address	0x84
Request Active Source	0x85
Set Stream Path	0x86
Device Vendor ID	0x87
Vendor Command	0x89
Give Device Vendor ID	0x8C
Menu Request	0x8D
Menu Status	0x8E
Give Device Power Status	0x8F
Report Power Status	0x90
Get Menu Language	0x91

## 6.2 Using HDMI CEC Messages

### ◀ CEC Command List

**Table 6-4. CEC Commands Supported by the LS-10i (continued)**

<b>Opcode</b>	<b>Value</b>
Inactive Source	0x9D
CEC Version	0x9E
Get CEC Version	0x9F
Vendor Command With ID	0xA0
Abort Message	0xFF
Polling Message	N/A

## 7. Specifications

Table 7-1 lists the LS-10i specifications.

**Table 7-1. LS-10i Specifications**

<b>Projector Type:</b>	Digital Light Processing™ (DLP), 3-chip, 16:9 SuperOnyx™ DMD™
<b>Video Processing:</b>	Runco advanced ViVix processing with 10 bit independent dual channel image processing, true 1080i deinterlacing, latest motion adaptive processing, 3D noise reduction, detail enhancement, rich color processing and noise reduction, less than one frame latency
<b>Native Resolution:</b>	1,920 x 1,080 (2,073,600 pixels)
<b>Aspect Ratios:</b>	16:9, Letterbox, 4:3, VirtualWide, Cinema, Virtual Cinema (Anamorphic lens compatible)
<b>Projection Modes:</b>	Front, Rear, Ceiling (front/rear)
<b>Video Standards:</b>	NTSC, PAL, SECAM, GEA-861D
<b>DTV Compatibility:</b>	480i, 480p, 576i, 576p, 720p, 1080i 50/60, 1080p 24/50/60
<b>Picture Size (16:9 Screen):</b>	Recommended Width: 72 - 120 in. Maximum Width: 180 in.
<b>Throw Distance (Factor x Screen Width):</b>	Refer to Table 3-3
<b>Lens System:</b>	Motorized focus, zoom, vertical and horizontal shift
<b>Vertical Lens Shift Range:</b>	<b>Proteus 1:</b> None <b>Proteus 2, 3, 4, 5, 6:</b> 65% of screen height above or below lens center (130% of one half of the screen height)
<b>Horizontal Lens Shift Range:</b>	<b>Proteus 1:</b> None <b>Proteus 2, 3, 4, 5, 6:</b> 30% of screen width left or right of lens center (60% of one half of the screen width)
<b>Lamp:</b>	230/260W (selectable) HPM lamp
<b>Estimated Lamp Life:</b>	2000 hours, typical (260W power setting); 3000 hours, typical (230W power setting);
<b>Cooling Performance:</b>	High efficiency adaptive voltage side-to-side cooling with low system acoustic noise level and low light pollution cabinet
<b>Calibration:</b>	ISF Certified Calibration Configuration
<b>Color Gamut:</b>	> BT.709 (REC709)

### 7.1 LS-10i Specifications

**Table 7-1. LS-10i Specifications (continued)**

<b>(2) HDMI with HDCP:</b>	HDTV RGB and Component, EDTV, SDTV, HDMI (High Definition Multimedia Interface) with HDCP (High Bandwidth Digital Content Protection), DVI via adapter (not included)
<b>(1) Component (3 x RCA, gold):</b>	HDTV, EDTV, SDTV SCART RGBS via component and composite inputs (adapter not included)
<b>(1) Component (3 x BNC, 75 ohm):</b>	HDTV, EDTV, SDTV
<b>(1) RGB (HD15):</b>	HDTV, RGBHV, YUV, EDTV
<b>(1) S-Video (4-pin mini-DIN):</b>	SDTV
<b>(1) Composite (RCA, gold):</b>	SDTV
<b>(2) 3.5mm mini jack:</b>	12V (+/-1.5V) screen trigger (250mA)
<b>(1) 9 pin D-sub:</b>	RS-232 for discrete commands and software upgrades <b>Communication Parameters:</b> 38400 bps, no parity, 8 data bits, 1 stop bit, no flow control
<b>(1) 3.5mm mini jack:</b>	IR input for Niles/Xantech compatible IR repeater systems <b>Communication Protocol:</b> Conforms to NEC standard IR protocol, 38-kHz carrier frequency, custom code = 0x20DF
<b>Menu Languages:</b>	English, French, Italian, German, Spanish, Swedish, Portuguese, Russian
<b>Communication and Control:</b>	HDMI Consumer Electronics Control (CEC) messages, RS-232, IR remote, on-board keypad
<b>Power Requirements:</b>	100 to 240 VAC (auto-sensing), 50/60 Hz, 400 Watts (1365.2 BTUs/hour)
<b>Operating Temperature:</b>	50°F to 104°F (10°C to 40°C)
<b>Operating Altitude:</b>	Sea Level - 10,000 feet (3,048m)
<b>Operating Humidity:</b>	0% to 85% non-condensing
<b>Dimensions:</b>	25.3" (643mm) L x 20.4" (519mm) W x 8.9" (225mm) H (see Figure 7-1)

Table 7-1. LS-10i Specifications (continued)

<b>Brightness and Contrast:</b>	<p><b>Cinema Standards Measurement System (CSMS) Specifications</b></p> <ul style="list-style-type: none"> <li>- Brightness: 119 foot-Lamberts (fL)</li> <li>- Contrast Ratio: 251:1</li> </ul> <p>These measurements are taken from the projector in a controlled, home theater environment. All measurements are made to ANSI/NAPM IT7.228-1997 specifications using the Photo Research PR-650 SpectraColorimeter and Minolta LS-100 Luminance Meter, Video Essentials test DVD and a 1.3 gain, 72-inch wide screen. The projector is calibrated to a color temperature of 6,500K and has a minimum of 150 hours of usage.</p> <p>The foot-Lambert (fL) is the unit of measurement used in commercial movie theaters to express image brightness at the screen surface. The Society of Motion Picture and Television Engineers (SMPTE) specifies 16 fL as the target image brightness for film-based projectors using an open gate (without film in the projector). More importantly, today SMPTE specifies 12 fL as the target image brightness in Digital Cinema theaters. The foot-Lambert measurement is dependent on screen size, screen gain and projector light output.</p> <p><b>Home Theater Calibration Specifications</b></p> <ul style="list-style-type: none"> <li>- Light Output: 1845 ANSI Lumens</li> <li>- Contrast Ratio: 251:1</li> </ul> <p>These specifications are obtained by calibrating the projector as described above for CSMS measurements.</p> <p><b>Industry-Standard Specifications</b></p> <ul style="list-style-type: none"> <li>- Light Output: 2100 ANSI Lumens</li> <li>- Contrast Ratio: 10,000:1 full-on, full-off (dynamic)</li> </ul> <p>These are typical projector brightness and contrast specifications found in most companies' sales literature. Runco includes these measurements in its literature to allow for direct comparison with other manufacturers' projectors. These measurements are typically taken at 9,000K to 13,000K to get expected performance data when the projector is used in professional, commercial and industrial displays.</p>
<b>Weight (without lens):</b>	40.8 lbs. (18.50 kg)
<b>Regulatory Approvals:</b>	FCC Part 15 Class B, CE Class B, UL, cUL, CB, RoHS, WEEE, local conformances as required
<b>Limited Warranty:</b>	<p>Projector: Two (2) years parts and labor from the date of shipment from Runco. RuncoCare™ and Runco RedCarpet™ plans are also available.</p> <p>Lamp: 1000 hours or six (6) months, whichever comes first.</p>
<b>Specifications are subject to change without notice.</b>	

## 7.2 LS-10i Dimensions

Figure 7-1 shows the LS-10i dimensions, in [millimeters] and inches.

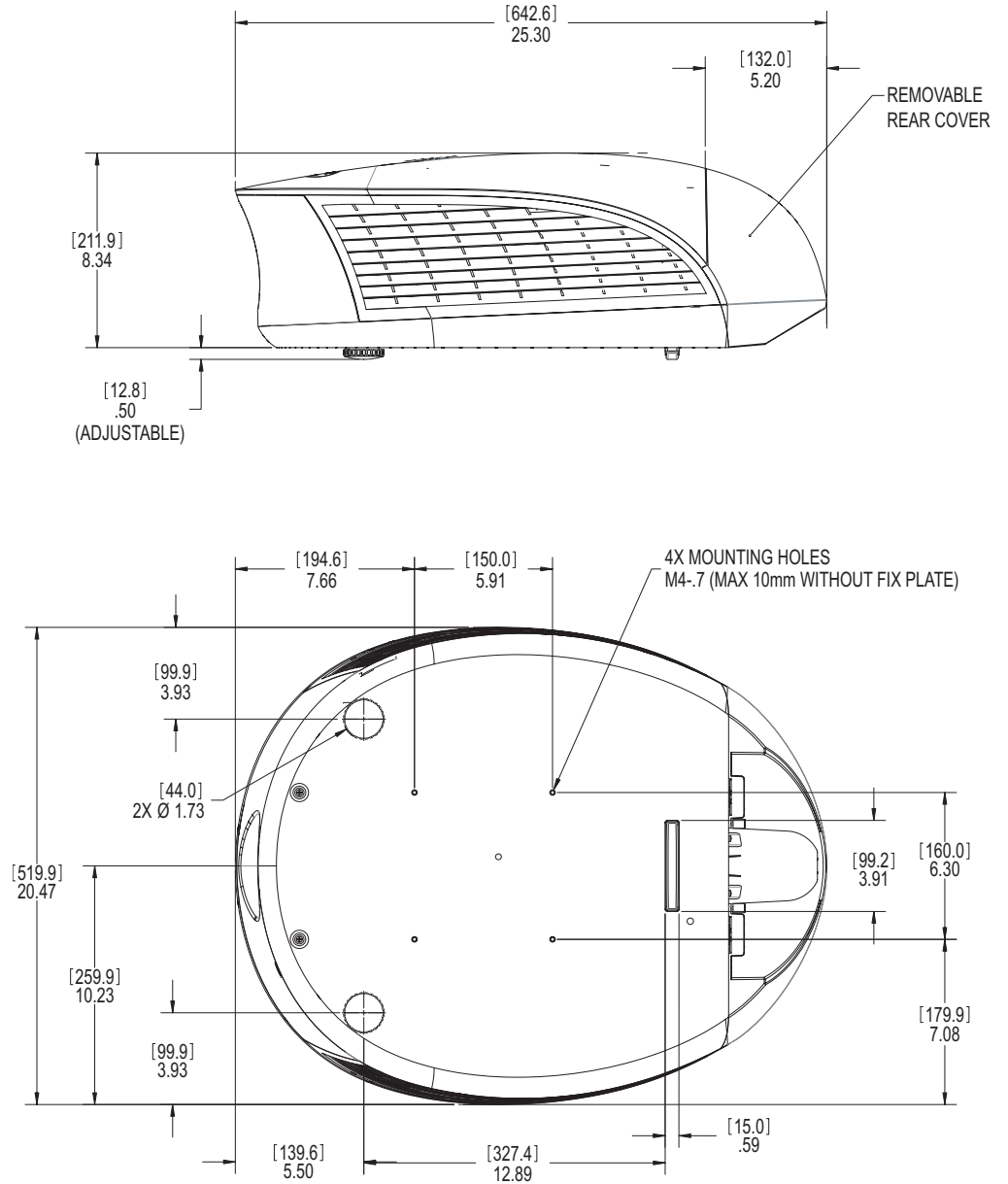

Figure 7-1. LS-10i Dimensions



Table 7-2 lists the signal types supported by each input on the LS-10i.

## 7.3 Supported Timings

**Table 7-2. Supported Signal Timings by Input**

Format	Resolution	Refresh Rate (Hz)	Horizontal Frequency (kHz)	Pixel Frequency (MHz)	Supported? (√ = Yes, – = No)			
					RGB	Component 1 Component 2	HDMI 1 HDMI 2	Composite S-Video
640x480	640x480	60.00	31.469	25.175	√	–	√	–
		66.59	35.892	29.862	√	–	√	–
		75.00	37.500	31.500	√	–	√	–
		85.00	43.269	36.000	√	–	√	–
800x600	800x600	60.00	37.879	40.000	√	–	√	–
		75.00	46.875	49.500	√	–	√	–
		85.00	53.674	56.250	√	–	√	–
832x624	832x624	74.54	52.849	60.036	√	–	√	–
848x480	848x480	48.00	25.270	27.089	√	–	√	–
		60.00	31.020	33.750	√	–	√	–
1024x768	1024x768	60.00	48.363	65.000	√	–	√	–
		75.00	60.023	78.750	√	–	√	–
		85.00	68.677	94.500	√	–	√	–
1280x720	1280x720	47.95	37.833	64.769	√	–	√	–
1280x1024	1280x1024	60.00	63.981	108.000	√	–	√	–
		75.00	79.976	135.000	√	–	√	–
		85.00	91.146	157.500	√	–	√	–
1600x1200	1600x1200	60.00	75.000	162.000	√	–	√	–
1680x1050	1680x1050	59.94	69.830	164.240	√	–	√	–
1920x1080	1920x1080	47.95	56.821	150.007	√	–	√	–
480/60i	720x487	59.94	15.734	13.500	–	√	√	√
480/60p	720x483	59.94	31.469	27.000	√	√	√	–
576/50i	720x576	50.00	15.625	14.750	–	√	√	√
576/50p	720x576	50.00	31.250	29.000	√	√	√	–
720/50p	1280x720	50.00	37.500	75.250	√	√	√	–
720/60p	1280x720	60.00	45.000	74.250	√	√	√	–
1080/50i	1920x1080	50.00	28.125/31.250	74.250/72.000	√	√	√	–
1080/60i	1920x1080	59.94/60.00	33.716/33.750	74.175/74.250	√	√	√	–
1080/24p	1920x1080	23.98/24.00	26.978/27.000	74.175/74.250	√	√	√	–

**Table 7-2. Supported Signal Timings by Input (continued)**

Format	Resolution	Refresh Rate (Hz)	Horizontal Frequency (kHz)	Pixel Frequency (MHz)	Supported? (√ = Yes, – = No)			
					RGB	Component 1 Component 2	HDMI 1 HDMI 2	Composite S-Video
1080/50p	1920x1080	50.00	56.250	148.500	√	√	√	–
1080/60p	1920x1080	59.94/60.00	67.433/67.500	148.350/148.500	√	√	√	–
NTSC 3.58	–	59.94/60.00	15.734/15.750	3.580	–	–	–	√
NTSC 4.43	–	59.94/60.00	15.734/15.750	4.430	–	–	–	√
PAL-B/G	–	50.00	15.625	4.430	–	–	–	√
PAL-M	–	59.94/60.00	15.734/15.750	3.580	–	–	–	√
PAL-N	–	50.00	15.625	3.580	–	–	–	√
PAL-60	–	59.94/60.00	15.734/15.750	4.430	–	–	–	√
SECAM	–	50.00	13.500	4.250/4.410	–	–	–	√



020-1075-00 Rev. A  
September 2010