



Table of contents

- Package Content.....2
- Getting started.....3
- Description of the device.....4
- Through the Wizard.....5
- Connecting to a WiFi network.....6
- The Android™ interface.....8
- Getting familiar with Android™12
- Using your keyboard.....14
- Troubleshooting.....16

For more information, please consult the FAQs and the User manual of your product on www.archos.com. Make sure to read them before considering any product return. Your deal may be no big deal.



Package Content

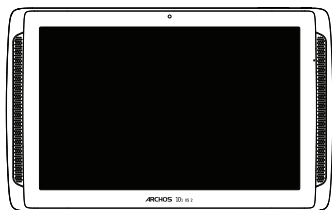

ARCHOS 101 XS 2



QSG booklet



Warranty,
legal & safety booklet

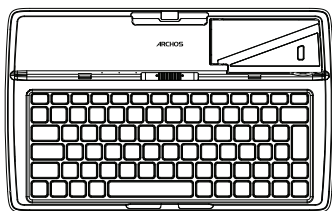

ARCHOS 101 XS 2 keyboard



USB cable

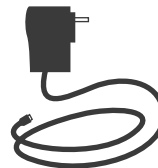

Charger



Getting Started

Charging

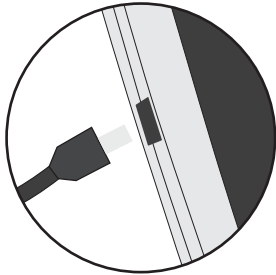

Charge your device by plugging your power cable into the micro-USB port. The ARCHOS device will turn on and start charging. The charging indicator light is on when the battery is charging.

- You can use your ARCHOS whilst it charges.
- Let your device charge completely the first time you use it.
- Use only the supplied charger.

When your device is completely discharged, you need to charge it for at least 10 minutes before the charging battery icon can be displayed.

TIPS:

To receive more complete service, please register your product.
From a computer, go to www.archos.com/register.



Description of the device

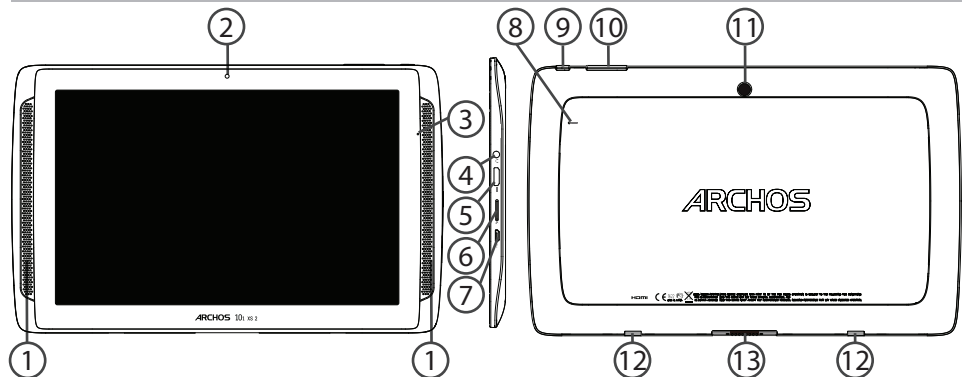

- ① Loudspeakers
- ② Webcam
- ③ Charging indicator
- ④ Headphone jack
- ⑤ Mini-HDMI video output*
- ⑥ Micro-SD card slot
- ⑦ Micro-USB port
- ⑧ Reset button
- ⑨ ON/OFF button
- ⑩ Volume buttons
- ⑪ Camera
- ⑫ Holding magnets
- ⑬ Proprietary port

* With optional Micro-HDMI to HDMI cable.



Through the Wizard

The first time you start up your ARCHOS, the installation wizard will help you set up your device:

- Touch-screen calibration
- Language
- Date & time
- WiFi connection
- Location service options
- 3rd party apps

TIPS:

We recommend that you set up your device in the WiFi zone of the network that you will regularly be using.



Connectivity to a WiFi Network

CAUTION: Make sure that you are in a WiFi zone.



① Touch and hold the time & battery icons to reveal the status bar. A blue line is displayed.



② Pull the blue line down to display the status dashboard.



③ Touch "WiFi off" in the status dashboard. The WiFi page will be displayed.



④ Slide the WiFi switch to "ON" position.

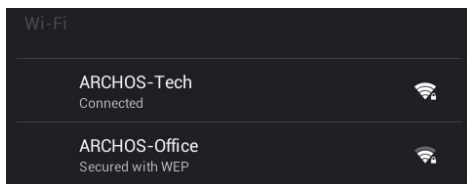

⑤ The ARCHOS will scan for WiFi networks in range. Touch the name of network you want to connect to.

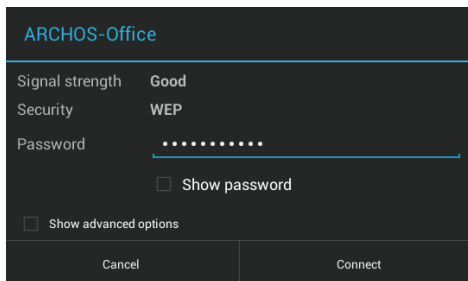

Private networks are shown with a lock icon and will require you to enter your password.

TIPS:

- When entering a WiFi password, we recommend that you select "Show password" so you can see the characters you are typing. To get the correct WiFi password (or settings) for the network, contact the WiFi network provider. If your WiFi is on and you are in range of a network that you previously connected to, your ARCHOS will automatically attempt to connect to it.
- To keep your WiFi connection ON when the device is on sleep, select the Menu icon in the "WiFi" page. Then, select Advanced > Keep WiFi on during sleep > Always.

The Android™ Interface



-
- ① **Google™ Search**
> Touch "Google" for text search or touch the microphone icon for voice search.
 - ② **Android™ apps shortcuts**
> Touch to start an application.
 - ③ **Permanent Android™ apps shortcuts**
> Touch to start an application
 - ④ **Back button**
 - ⑤ **Home button**
 - ⑥ **Recent apps buttons**
 - ⑦ **All Apps button**
> Touch this icon to show all the applications and widgets installed on your ARCHOS. All your downloaded applications are here.
 - ⑧ **The status bar**
> Displays notifications and quick settings

The Android™ Interface

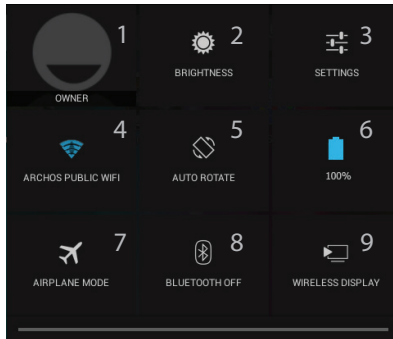

3:18 The Quick settings

- 1 Current user⁽¹⁾
- 2 To adjust the screen brightness.
- 3 To access all your settings.
- 4 To turn on/off your WiFi connection.
- 5 To activate/deactivate automatic screen orientation as you turn your ARCHOS.
- 6 Percentage of battery remaining
- 7 To activate/deactivate all wireless connections, especially when flying.
- 8 To turn on/off your Bluetooth connection.
- 9 To enable wireless display⁽²⁾

⁽¹⁾New multi-user support for tablets lets different users have their own separate, customizable spaces on a single device. Add users in Settings > Device.

⁽²⁾You can share movies, YouTube videos, and anything that's on your screen on an HDTV. You need to connect a wireless display adapter to any HDMI-enabled TV to mirror what's on your screen quickly and easily.

The Recent Apps

Opens a list of thumbnail images of apps you've worked with recently:

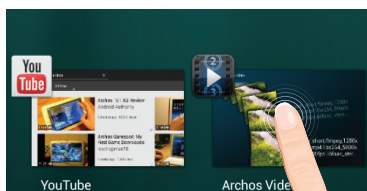

Touch: to open an app.

Hold down: to display options

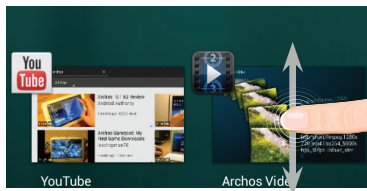

Swipe up or down: to close an app.

Getting familiar with Android™



The extended home screen:

Navigate between different home screen panels by swiping left and right.



Moving a home screen item:

Touch and hold your finger onto it until the positioning gridlines appear, then slide it to the desired location, and release your finger.



Removing a home screen item:

Touch and hold it, slide your finger towards the top of the screen and drop it over the Remove icon.



Uninstalling an item:

From the All apps screens, touch and hold it, slide your finger towards the top of the screen and drop it over Uninstall bin.



Creating application folders:

Drop one app icon over another on a home screen and the two icons will be combined.



Widgets:

Touch the All Apps icon on your home screen. Touch Widgets at the top of the screen. From the main Widgets screen, you can move around widgets just as you do for app icons.

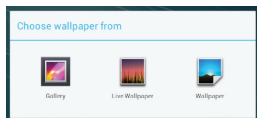

Changing your wallpaper:

Hold your finger on a home screen at an empty location, then choose from the list.

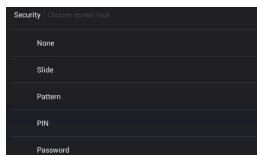

Locking the touchscreen:

In Settings, scroll down and touch security. Touch Screen lock. Touch the type of lock you would like to use. After you set a lock, a lock screen is displayed whenever your screen wakes up, requesting the pattern, PIN or other specified key.

Using your keyboard

The ARCHOS 101 XS 2 is equipped with a Hall effect sensor. When you cover the tablet with its coverboard, the screen turns off automatically. The screen turns on when you lift the coverboard.

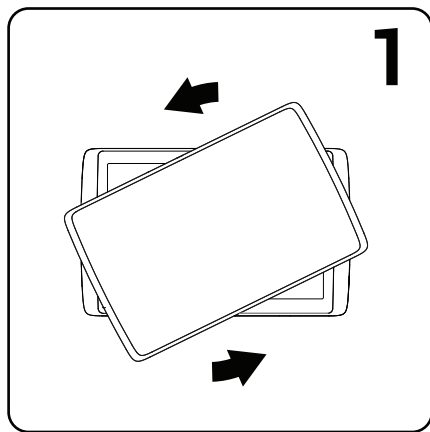

1. Twist and lift the tablet.

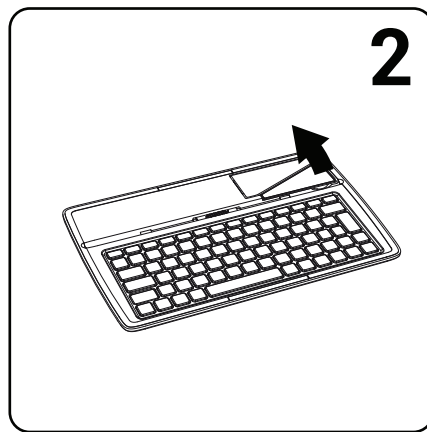

2. Lift and fold the tablet stand.

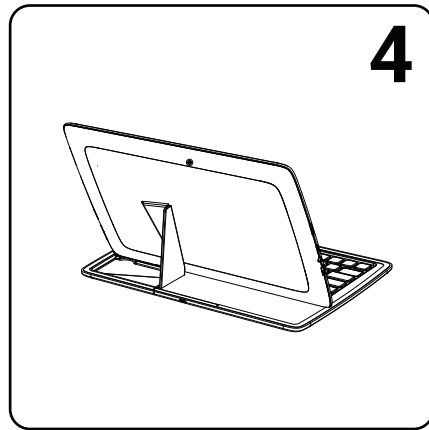
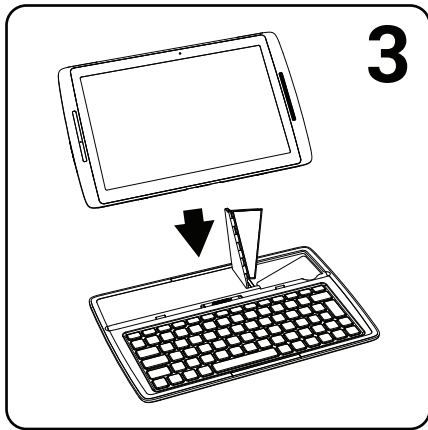

3. Place the tablet in the designated location. Rear view of the tablet





Troubleshooting

If your device is frozen:

Use the Hardware reset. To use the Hardware reset, press the “pinhole reset” button by using a sharp object such as a toothpick.

If your device doesn't turn on:

1. Charge your device.
2. Use the Hardware reset.

If you want to extent the life of your battery:

Decrease the screen brightness and turn off the wireless connections if not in use.

If your device functioning is too slow:

Close all apps which are not currently used. Use the System Monitor app.

If your WiFi reception is too low:

Make sure you are not far from the WiFi hotspot.

Update the firmware of the device: <http://www.archos.com/support>.

Reset and redefine your connection parameters.

Contact your WiFi connection provider.

If you want to restore your product (forgotten password? erase all your settings?) :

While holding Volume+, press the ON/OFF button to turn on the device.

Once the green robot ANDROID is displayed, release the volume+ button.

Press and hold the ON/OFF button and press once the volume+ button.

The Android system recovery is displayed.

Use the Volume buttons to scroll and the ON/OFF button to validate.

Select “Wipe data/factory reset” and validate.

Select “Yes -- delete all user data” and validate.

Select “Reboot system now” and validate.



Table des matières

Contenu de la boîte.....18

Mise en route.....19

Description de l'appareil.....20

Assistant de démarrage.....21

Se connecter à un réseau WiFi.....22

L'interface Android™24

Se familiariser avec Android™28

Utilisation de votre clavier.....30

Dépannage.....32

Pour plus d'informations, consultez-les FAQs et le manuel d'utilisateur de votre produit sur www.archos.com. Consultez-les avant d'envisager un éventuel retour du produit. Le problème que vous rencontrez peut être résolu facilement.



Contenu de la boîte

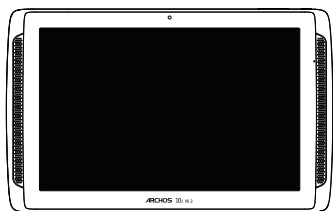

ARCHOS 101 XS 2

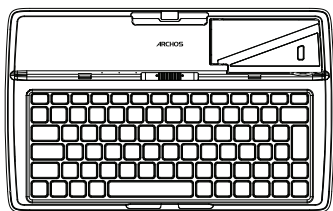

Clavier ARCHOS 101 XS 2



Guide d'utilisation
rapide



Guide des garanties et
des mentions légales



Câble USB

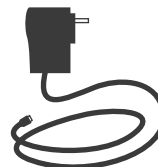

Chargeur

Mise en route

FR

Chargez la tablette

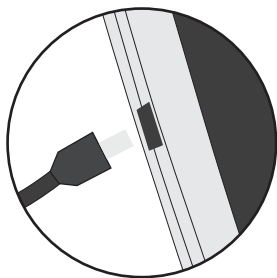

Connectez le câble d'alimentation à votre produit via le port micro-USB. La tablette s'allume et commence à se charger. Le témoin de charge est vert lorsque la tablette est en charge.

- Vous pouvez utiliser votre tablette pendant le chargement.
- Lors de la première utilisation, chargez complètement la batterie.
- Utilisez uniquement le chargeur fourni.

Lorsque votre tablette est complètement déchargée, il faut la laisser charger pendant 10 minutes minimum avant que l'icône de charge ne puisse s'afficher.

ASTUCES:

Pour bénéficier d'une assistance complète, enregistrez votre produit. A partir de votre ordinateur, allez sur www.archos.com/register.

Description de l'appareil

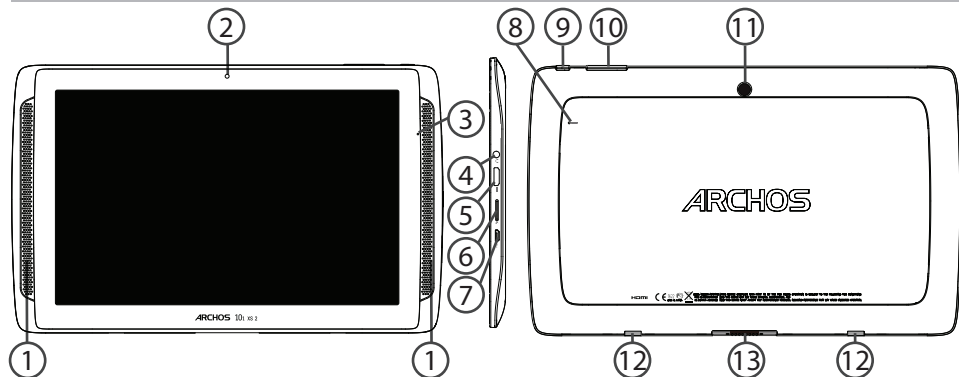

- ① Loudspeakers
- ② Webcam
- ③ Témoin de charge
- ④ Entrée jack audio
- ⑤ Sortie vidéo mini-HDMI*
- ⑥ Lecteur carte micro-SD
- ⑦ Port micro-USB
- ⑧ Bouton Reset
- ⑨ Bouton ON/OFF
- ⑩ Boutons de volume
- ⑪ Appareil photo
- ⑫ Aimants de fixation
- ⑬ Port propriétaire

* Câble vidéo (Mini-HDMI vers HDMI) non-fourni.



L'assistant de démarrage

FR

La première fois que vous allumez votre tablette, l'assistant de démarrage vous permet de paramétrer votre appareil :

- Langue
- Date & heure
- Connexion WiFi
- Les options du service de localisation
- Applications tierces

ASTUCES :

Pour le paramétrage de votre appareil, nous vous recommandons de vous placer dans la zone WiFi du réseau que vous utilisez régulièrement.



Se connecter à un réseau WiFi

ATTENTION : assurez-vous d'être dans une zone WiFi.



① Sélectionnez les icônes Heure et Batterie en maintenant votre doigt appuyé. Une barre bleue s'affiche.



② Tirez vers le bas la barre bleue pour afficher le panneau des statuts.



③ Sélectionnez "WiFi éteint" dans le panneau des statuts. L'écran "WiFi" s'affiche.



④ Si le WiFi est éteint, faites-glisser l'interrupteur WiFi sur la position "OUI".

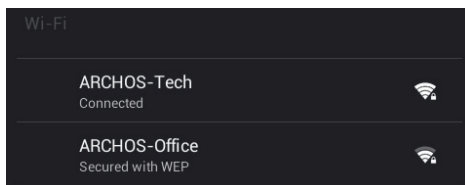

⑤ Une fois que le WiFi est activé, la tablette recherche des réseaux WiFi à portée. Sélectionnez le nom du réseau auquel vous voulez vous connecter.

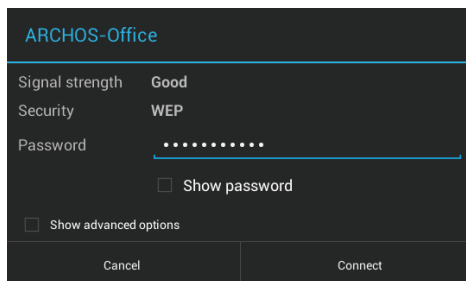

Les réseaux privés sont affichés avec un cadenas. Ils nécessitent un mot de passe.

ASTUCES :

- Lorsque vous saisissez un mot de passe, nous vous recommandons de cocher «Afficher mot de passe» afin de voir les caractères que vous saisissez. Pour obtenir le mot de passe ou les paramètres du réseau WiFi, contactez le fournisseur d'accès à Internet. Si votre WiFi est activé et que vous êtes à portée d'un réseau auquel vous vous êtes déjà connecté, votre tablette tente d'établir automatiquement une connexion.
- Pour maintenir votre connexion WiFi active lorsque la tablette est en veille, sélectionnez l'icône de Menu dans l'écran "WiFi", puis sélectionnez Options avancées > WiFi actif en veille > Toujours.

L'interface Android™



- ① **Google™ Search**
> Sélectionnez "Google" pour saisir votre recherche ou l'icône microphone pour l'énoncer.
- ② **Raccourcis d'applications Android™**
> Sélectionnez une application pour l'ouvrir.
- ③ **Raccourcis permanents d'applications Android**
- ④ **"Retour"**
- ⑤ **"Accueil"**
- ⑥ **"Applications récentes"**
- ⑦ **"Toutes les Applications"**
> Sélectionnez pour afficher toutes les applications et les widgets installés sur votre ARCHOS. Vous retrouverez toutes vos applications téléchargées.
- ⑧ **Barre de statuts**
> Elle affiche les notifications et permet l'accès aux réglages rapides.

L'interface Android™

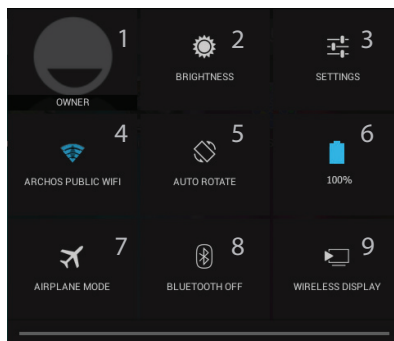

3:18 Les Réglages rapides

- 1 Affiche l'icône de l'utilisateur actuel⁽¹⁾.
- 2 Pour ajuster la luminosité de l'écran.
- 3 Pour accéder à tous vos paramètres.
- 4 Pour activer/désactiver votre connexion WiFi.
- 5 Pour activer/désactiver l'orientation automatique de l'écran dès que vous tournez votre tablette.
- 6 Pourcentage de batterie restant
- 7 Pour activer/désactiver toutes les connexions sans fil. Par exemple, pour prendre l'avion.
- 8 Pour activer/désactiver votre connexion Bluetooth.
- 9 Pour permettre l'affichage sans fil⁽²⁾

⁽¹⁾Cette option permet à différents utilisateurs d'une même tablette d'avoir chacun son propre espace personnalisable. Ajoutez des utilisateurs à partir de Paramètres > Appareil.

⁽²⁾Vous pouvez partager sur votre téléviseur HD des films, des vidéos de YouTube et tout autre média affiché sur votre tablette. Il faut au préalable connecter un adaptateur Wi-Di au port HDMI de votre téléviseur pour dupliquer facilement et rapidement ce qui est affiché sur votre tablette.



Les Applications récentes

L'application affiche une liste de vignettes des applications utilisées récemment.

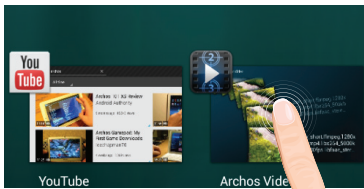

Pour afficher une application, sélectionnez-la.

Pour afficher des informations, maintenez appuyé.

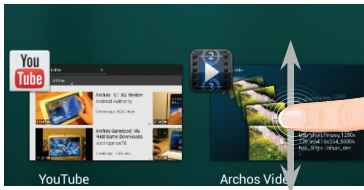

Pour fermer une application, faites-la glisser vers le haut ou vers le bas.



Se familiariser avec Android™



L'écran d'accueil étendu :

Naviguez entre les différents écrans d'accueil en faisant glisser votre doigt vers la gauche ou vers la droite.

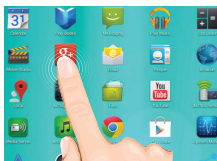

Déplacer une icône de l'écran d'accueil :

Maintenez votre doigt appuyé sur l'icône jusqu'à ce que s'affichent les lignes de positionnement, puis faites-la glisser vers l'emplacement souhaité, et relâchez.

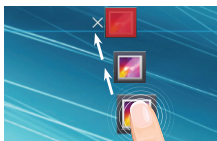

Supprimer une icône de l'écran d'accueil :

Maintenez votre doigt appuyé sur l'icône, puis faites-la glisser vers le haut de l'écran, et déposez-la sur l'icône "Supprimer".



Désinstaller une application :

A partir de l'écran "Toutes les applications", maintenez votre doigt appuyé sur l'icône, puis faites-la glisser vers le haut de l'écran et déposez-la sur l'icône "Désinstaller".



Créer des dossiers d'applications :

A partir d'un écran d'accueil, déposez une icône sur une autre pour les rassembler.



Widgets :

Sélectionnez l'icône "Toutes les applications". Sélectionnez "Widgets" en haut de l'écran. A partir de l'écran d'accueil des widgets, vous pouvez déplacer les widgets de la même façon que vous procédez avec les applications.

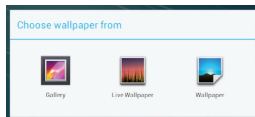

Changer le fond d'écran :

Maintenez votre doigt appuyé sur un emplacement vide de l'écran, puis choisissez parmi la liste d'options.

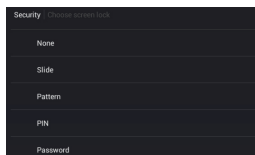

Verrouiller votre tablette :

A partir du panneau des réglages rapides dans la barre de statut, sélectionnez "Paramètres". Faites défiler l'écran vers le bas, puis sélectionnez "Sécurité". Sélectionnez "Verrouillage de l'écran". Sélectionnez le type de verrouillage que vous voulez utiliser. Une fois que vous avez sélectionné une option, un écran de verrouillage s'affiche chaque fois que votre écran est réactivé. Vous êtes alors invité à saisir le schéma, le code PIN ou tout autre code spécifié.



Utilisation de votre clavier

L'ARCHOS 101 XS 2 est équipé d'un capteur à effet hall. Lorsque vous couvrez la tablette avec son clavier, l'écran s'éteint automatiquement. L'écran se rallume lorsque vous enlevez le clavier.

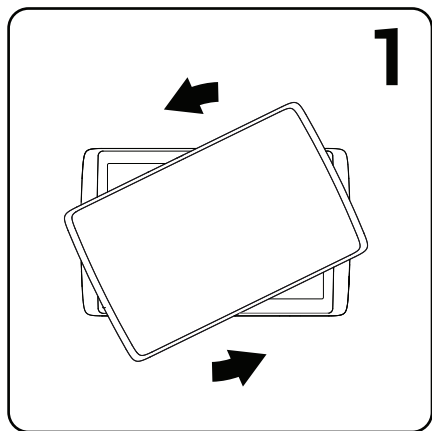

1. Faites pivoter la tablette pour la séparer du clavier et soulevez-la.

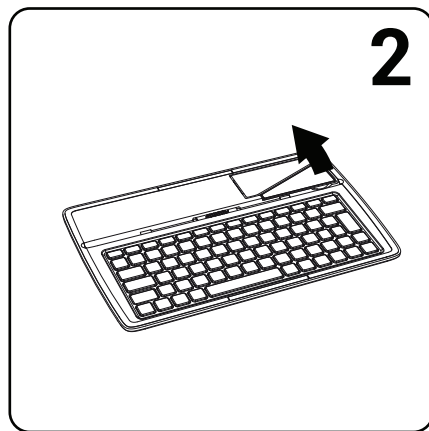

2. Soulevez la béquille et pliez-la.



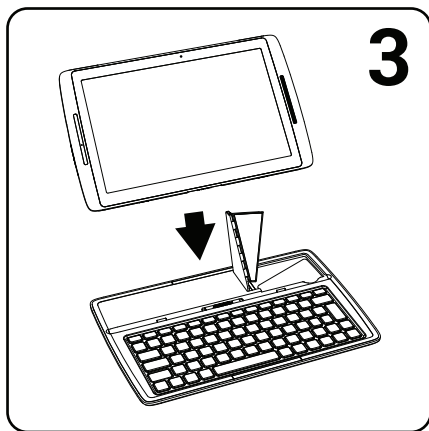

3. Placez la tablette sur l'emplacement spécifié.

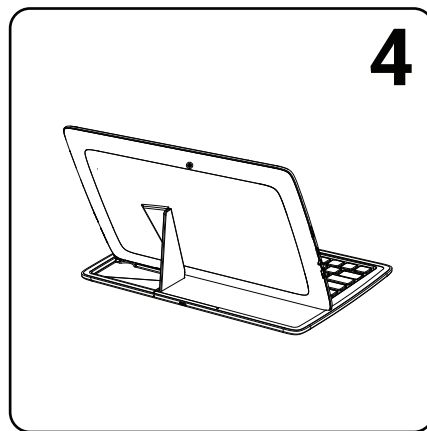

Vue arrière de la tablette placée sur le clavier.



Dépannage

Si votre appareil ne répond pas :

Appuyez sur le bouton ON/OFF pendant 10 secondes.

Si votre appareil ne s'allume pas :

1. Chargez votre appareil.
2. Appuyez sur le bouton ON/OFF pendant 10 secondes.

Si votre appareil est complètement déchargé :

Chargez-le pendant 10 minutes minimum avant qu'il ne puisse s'allumer.

Si vous voulez prolonger l'autonomie de votre batterie :

Diminuez la luminosité de l'écran et désactivez les connexions sans fil si elles sont inutilisées.

Si votre appareil fonctionne au ralenti :

Fermez les applications qui ne sont pas en cours d'utilisation.

Si votre réception WiFi est trop faible :

Assurez-vous de ne pas être trop loin de la borne WiFi.

Mettez à jour le logiciel du produit: <http://www.archos.com/support>.

Réinitialisez vos paramètres de connexion WiFi.

Contactez le fournisseur d'accès.

Si vous voulez restaurer les valeurs d'usine (mot de passe oublié? effacer tous vos réglages?) :

1. En maintenant volume+ enfoncé, branchez le câble d'alimentation fourni sur le connecteur d'alimentation et sur une prise secteur.
2. Une fois que le robot vert Android s'affiche, relâchez le bouton de volume+.
3. Maintenez enfoncé le bouton ON/OFF et appuyez une fois sur le bouton volume+.
Le système de restauration d'Android est affiché.
4. Utilisez les boutons de volume pour défiler et le bouton ON/OFF pour valider.
 - Sélectionnez "Wipe data/factory reset" et validez pour restaurer aux valeurs d'usine.
 - Sélectionnez "Yes -- delete all user data" et validez pour supprimer toutes les données utilisateur.
 - Sélectionnez "Reboot system now" et validez pour redémarrer le système.



Inhaltsverzeichnis

Beschreibung des Packungsinhalts.....	34
Erste Schritte.....	35
Beschreibung des Geräts.....	36
Installationsassistent.....	37
WiFi (WLAN)-Verbindung.....	38
Die Android™ Benutzeroberfläche.....	40
Android™ kennenlernen.....	44
Verwendung Ihrer Tastatur.....	46
Fehlersuche.....	48

Weitere Informationen finden Sie unter den FAQs sowie im Benutzerhandbuch zu Ihrem Produkt unter www.archos.com. Bitte lesen Sie diese Informationen sorgfältig, bevor Sie die Rückgabe eines Produkts erwägen. Möglicherweise lässt sich Ihr Problem leicht lösen.



Beschreibung des Packungsinhalts

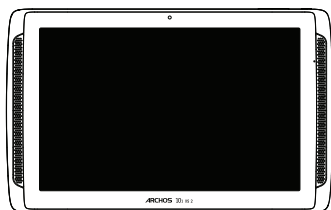

ARCHOS 101 XS 2



Benutzerhandbuch



Garantie, Impressum
und Sicherheitshinweise

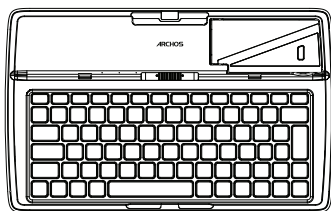

ARCHOS 101 XS 2 Tastatur



USB Kabel

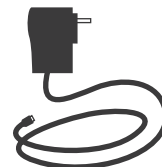

Ladegerät

Erste Schritte

Aufladen des Akkus

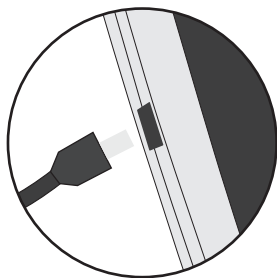

Laden Sie das Gerät auf, indem Sie das Netzkabel an den ARCHOS USB-Anschluss anschließen. Das ARCHOS-Gerät schaltet sich ein und beginnt zu laden. Das Licht der Ladeanzeige leuchtet, wenn die Batterie aufgeladen wird.

- Sie können den ARCHOS auch während des Ladens verwenden.
- Laden Sie Ihr Gerät vor der ersten Nutzung einmal vollständig auf.
- Verwenden Sie nur das mitgelieferte Netzgerät.

Hat sich Ihr Gerät komplett entladen, muss es für mindestens 10 Minuten geladen werden, bevor das Batterieladesymbol angezeigt werden kann.

TIPP:

Um unseren Service voll nutzen zu können, empfehlen wir Ihnen, Ihr Produkt zu registrieren. Für die Registrierung mittels Computer gehen Sie zu www.archos.com/register.

Beschreibung des ARCHOS

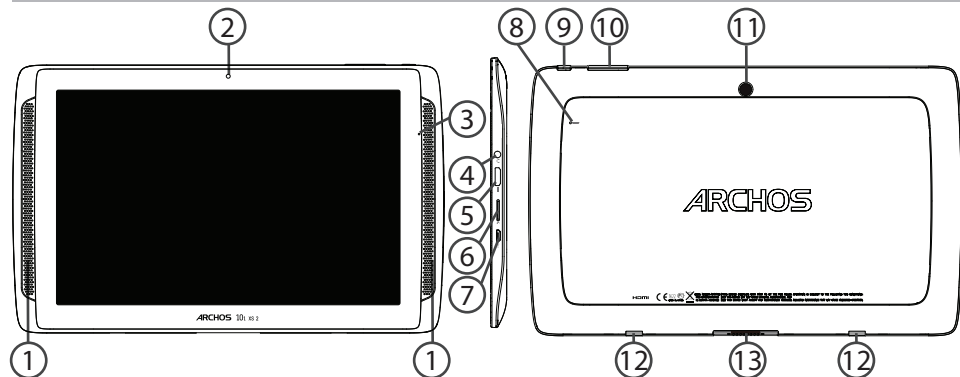

- | | | | |
|----------------------|-----------------------------|-----------------|-------------------------|
| ① Lautsprechern | ⑤ Mini HDMI Video Ausgang* | ⑨ EIN/AUS-Taste | ⑬ Proprietäre Anschluss |
| ② Webcam | ⑥ microSD Karten Steckplatz | ⑩ Lautstärke | |
| ③ Ladeanzeige | ⑦ Micro USB Port | ⑪ Kamera | |
| ④ Kopfhöreranschluss | ⑧ Hardware-Reset | ⑫ Halte-magnete | |

*Mit einem optionalen Video Kabel (HDMI / Mini HDMI).



Installationsassistent

DE

Wenn Sie Ihren ARCHOS das erste Mal in Betrieb nehmen, leitet Sie der Installationsassistent durch einige Bildschirme, um Ihnen dabei zu helfen, die grundlegenden Einstellungen vorzunehmen :

- Sprache
- Datum & Uhrzeit
- WLAN Verbindung
- Standortdienst
- Anwendungen von Drittanbietern

TIPP:

Definieren Sie die Parameter des Gerätes für das WiFi (WLAN) Netzwerk, das Sie regelmäßig verwenden.



WiFi (WLAN) Verbindung

ACHTUNG: Stellen Sie sicher, dass Sie sich innerhalb einer WiFi(WLAN)-Zone aufhalten.



① Berühren und halten Sie die Symbole für Uhrzeit und Batterie, um die Statusleiste freizulegen. Es wird eine blaue Linie angezeigt.



② Ziehen Sie die blaue Linie nach unten, um das Status-Dashboard anzuzeigen.



③ Tippen Sie auf "Wi-Fi off [WLAN aus]" im Status-Dashboard. Die WLAN-Seite wird jetzt angezeigt.



④ Wenn "WLAN" deaktiviert ist, schieben Sie den WLAN-Schalter in die Position "EIN".

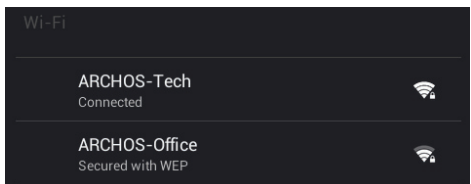

⑤ Sobald "WLAN" eingeschaltet ist, sucht der ARCHOS nach Netzwerken in Reichweite. Berühren Sie den Namen des Netzwerks, mit dem Sie verbunden werden möchten.

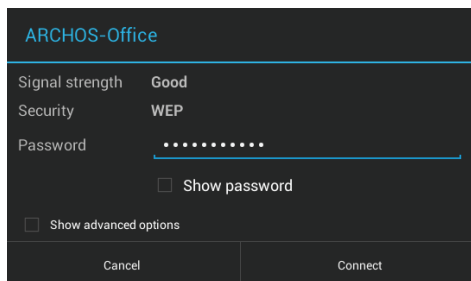

ARCHOS-Office

Signal strength Good

Security WEP

Password

Show password

Show advanced options

Cancel Connect

Gesicherte Netzwerke werden mit einem Schloß-Symbol angezeigt und erfordern die Eingabe eines Passworts.

TIPPS:

- Bei Eingabe eines WLAN-Passworts empfehlen wir Ihnen, «Show Password» (Passwort anzeigen) zu wählen. Das korrekte WLAN-Passwort (oder die Einstellungen) für das Netzwerk erhalten Sie von dem betreffenden WLAN-Provider. Wenn WLAN aktiviert ist und Sie sich in Reichweite eines Netzwerks befinden, mit dem Sie zuvor bereits verbunden waren, versucht der ARCHOS automatisch, eine Verbindung mit diesem Netzwerk herzustellen.
- Um die WLAN-Verbindung zu halten, während sich das Gerät im Standby-Modus befindet, wählen Sie das Menüsymbol auf der Seite "WLAN". Wählen Sie Erweitert>WLAN im Standby-Modus aktiviert lassen>Immer.

Die Android™ Benutzeroberfläche





- ① **Google™ Suche**
> Suchbegriff eintippen oder Spracheingabe verwenden.
- ② **Android™ Apps**
> Die Aktivierung einer App erfolgt durch Berühren.
- ③ **Permanenten Android™ Apps-Verknüpfungen**
- ④ **"Zurück"**
- ⑤ **"Startbildschirm"**
- ⑥ **"Letzte Apps"**
- ⑦ **"Alle Apps"**
> Berühren Sie dieses Symbol, um alle auf Ihrem ARCHOS installierten Apps und Widgets anzuzeigen. Alle heruntergeladenen Anwendungen befinden sich hier.
- ⑧ **Statusleiste**
> Auf der Statusleiste werden Benachrichtigungen und die Systemsymbole angezeigt.



Die Android™ Benutzeroberfläche

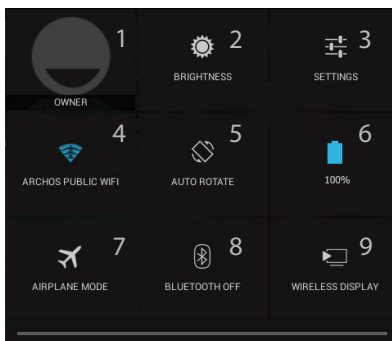

3:18 Schnelleinstellungen

- ① Aktueller Benutzer⁽¹⁾
- ② Einstellung der Bildschirmhelligkeit.
- ③ Zugriff auf alle Einstellungen.
- ④ Ein- und Ausschalten der WLAN-Verbindung.
- ⑤ Ermöglicht die Aktivierung und Deaktivierung der automatischen Display-Drehung.
- ⑥ Akkurestlaufzeit in Prozent
- ⑦ Beendet alle WLAN-Verbindungen, nützlich für Flugreisen.
- ⑧ Ein- und Ausschalten der Bluetooth-Verbindung.
- ⑨ Wireless Display aktivieren⁽²⁾

⁽¹⁾Mit dem neuen Multi-User-Support für Tablets besitzt jeder Benutzer seinen eigenen separaten und anpassbaren Bereich auf einem einzelnen Gerät. Benutzer können unter Settings > Device [Einstellungen > Gerät] hinzugefügt werden.

⁽²⁾Sie können Filme, YouTube-Videos und alles, was sich auf Ihrem Bildschirm befindet, auf einem HDTV teilen. Sie müssen ein Wireless Display-Adapter an einen HDMI-fähigen Fernseher anschließen, um so schnell und einfach den Inhalt Ihres Bildschirms wiederzugeben.



Letzte Apps

Öffnet eine Liste mit Mini-Abbildungen der kürzlich verwendeten Apps:

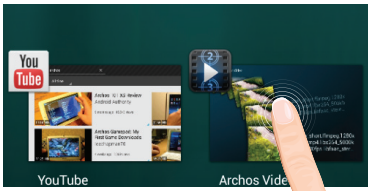

Tippen: öffnen einer Anwendung.

Länger drücken: Anzeige von Optionen

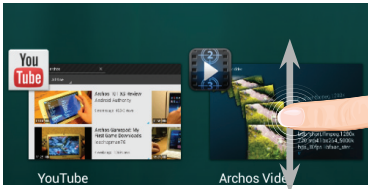

Nach oben oder unten wischen: Eine Anwendung schließen.



Android™ kennenlernen

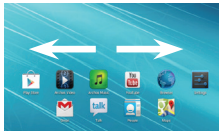

Der erweiterte Startbildschirm:

Wechseln Sie durch Wischen nach links und rechts zwischen verschiedenen «Home»-Bildschirmen.



Ein Element vom Startbildschirm verschieben:

Zum Verschieben eines Elements vom Startbildschirm den Finger darauf legen und so lange halten, bis die Rasterlinien zur Positionierung erscheinen. Dann an die gewünschte Stelle schieben und loslassen.



Ein Element vom Startbildschirm entfernen:

Den Finger auf das Element legen und halten. Den Finger auf dem Bildschirm nach oben bewegen und über dem «Entfernen»-Symbol loslassen.



Ein Element deinstallieren:

Auf den «Alle Apps»-Bildschirmen das betreffende Element berühren und halten. Den Finger im Bildschirm nach oben bewegen und über dem «Deinstallieren»-Papierkorb loslassen.

**Anwendungsordner erstellen:**

Ziehen Sie auf einem Startbildschirm ein Anwendungssymbol über ein anderes. Die beiden Symbole werden kombiniert.

**Widgets:**

Berühren Sie das «Alle Apps»-Symbol auf dem Startbildschirm. Berühren Sie «Widgets» oben auf dem Bildschirm. Auf dem «Widgets»-Hauptbildschirm können Sie Widgets genau wie Anwendungssymbole auch verschieben.

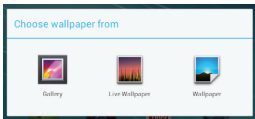
**Hintergrundbild ändern:**

Den Finger auf eine freie Stelle des Bildschirms legen und dann aus der Liste auswählen.

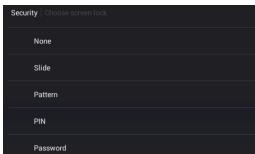
**Touchscreen sperren:**

Berühren Sie Einstellungen auf dem Schnelleinstellungen-Dashboard in der Statusleiste. Scrollen Sie nach unten und berühren Sie "Sicherheit". Berühren Sie Bildschirmssperrung. Berühren Sie die gewünschte Art der Sperrung. Nach erfolgter Sperrung wird ein Sperrbildschirm angezeigt, sobald der Bildschirm aktiviert wird. Auf diesem ist ein Muster, eine PIN oder ein anderer festgelegter Schlüssel einzugeben.





Verwendung Ihrer Tastatur

Das ARCHOS 101 XS 2 ist mit einem Hall-Sensor ausgestattet. Dieser Sensor sorgt dafür, dass das Display automatisch abschaltet, wenn das Coverboard als Tabletschutz verwendet wird. Das Display schaltet sich dann wieder ein, wenn das Coverboard (Tabletschutz) vom Tablet abgenommen wird.

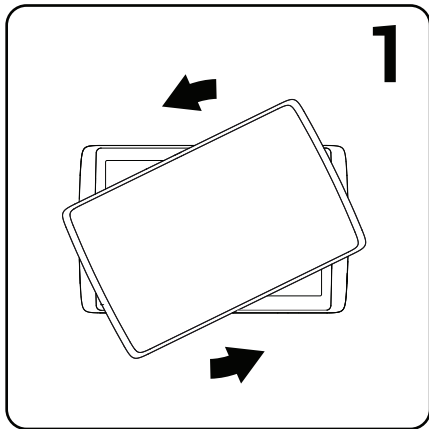

1. Trennen Sie das Tablet durch eine Drehbewegung von der Tastatur.

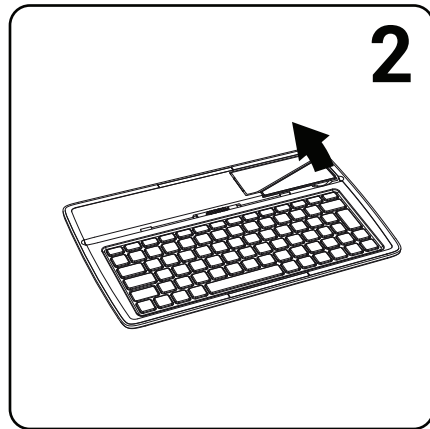

2. Klappen Sie den Aufsteller für das Tablet hoch.



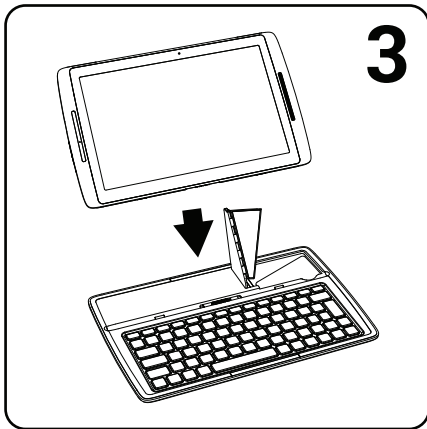

3. Platzieren Sie das Tablet an der dafür vorgesehenen Stelle der Tastatur.

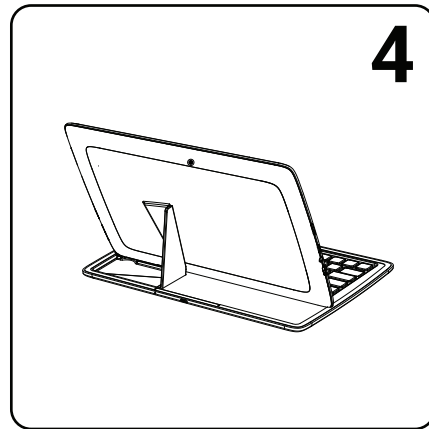

Rückseitige Ansicht des aufgestellten und mit der Tastatur verbundenen Tablets.



Fehlersuche

Das Gerät reagiert nicht mehr:

Halten Sie die EIN/AUS-Taste 10 Sekunden lang gedrückt.

Wenn sich das Gerät nicht wieder einschaltet:

1. Laden Sie das Gerät auf.
2. Halten Sie die EIN/AUS-Taste 10 Sekunden lang gedrückt.

Wenn Ihr Gerät vollständig entladen ist

Laden Sie das Gerät für mindestens 10 Minuten, bevor es eingeschaltet wird.

Akkulaufzeit verlängern:

Verringern Sie die Bildschirmhelligkeit und schalten Sie die WiFi(WLAN)-Verbindungen aus, wenn diese nicht verwendet werden.

Das Gerät ist zu langsam:

Schließen Sie alle Anwendungen, die nicht verwendet werden.

WiFi(WLAN)-Empfang ist zu schwach:

Stellen Sie sicher, dass Sie sich in Reichweite eines WiFi(WLAN)-Hotspots befinden.

Aktualisieren Sie die Firmware des Gerätes: <http://www.archos.com/support>.

Setzen Sie die WiFi-Verbindung zurück.

Kontaktieren Sie Ihren WiFi(WLAN)-Provider.

Wenn das Produkt zurückgesetzt werden soll (Passwort vergessen? Löschen Ihrer Einstellungen?):

1. Halten Sie Lautstärketaste+ und verbinden Sie das mitgelieferte Stromkabel mit dem ARCHOS und mit einer Steckdose.
2. Sobald der grüne Roboter ANDROID wird angezeigt, Release Lautstärketaste+.
3. Drücken und halten Sie die ON / OFF-Taste und drücken Sie einmal die Lautstärketaste+.
Das Android-System Recovery wird angezeigt.
4. Scrollen Sie mit den Lautstärketasten und bestätigen Sie mit der EIN/AUS-Taste.
 - Wählen Sie "Wipe data/factory reset (Daten löschen/Werkseinstellung)" und bestätigen Sie.
 - Wählen Sie "Yes -- delete all user data (Ja -- alle Benutzerdaten löschen)" und bestätigen Sie.
 - Wählen Sie "Reboot system now (System jetzt neu starten)" und bestätigen Sie.



Índice

Contenido de la caja.....	50
Procedimientos iniciales.....	51
Descripción del ARCHOS.....	52
Asistente de inicio.....	53
Conexión a una red WiFi.....	54
La interfaz Android™	56
Para familiarizarse con Android™	60
Uso del teclado.....	62
Solución de problemas.....	64

Para obtener más información, consulte la sección de preguntas frecuentes y el manual de usuario del producto en la dirección www.archos.com. Asegúrese de leerlos antes de considerar devolver el producto. Puede haber una solución fácil a su problema.



Contenido de la caja

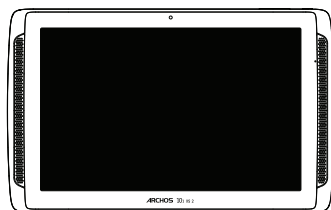

ARCHOS 101 XS 2



Guía de usuario



Avisos de garantía,
legales y de seguridad

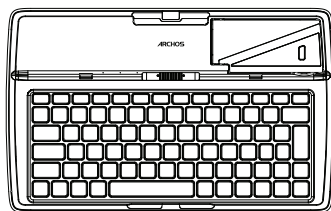

ARCHOS 101 XS 2 teclado



Cable USB

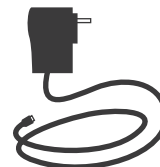

Cargador

Procedimientos iniciales

Cargado de la batería

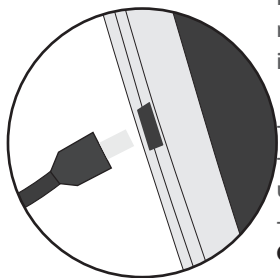

Para cargar el dispositivo, conecte el cable de alimentación al puerto micro-USB. El dispositivo ARCHOS se encenderá e iniciará la carga. El indicador de carga se enciende mientras se carga la batería.

- Puede utilizar el ARCHOS mientras se carga.
- Deje cargar completamente el dispositivo la primera vez que lo utilice.
- Utilice únicamente el cargador suministrado.

Cuando el dispositivo está completamente descargado, deberá cargarlo durante al menos 10 minutos antes de que aparezca el icono de carga de batería.

CONSEJOS:

Para recibir una asistencia más completa, registre su producto. Con un ordenador, vaya a www.archos.com/register.

ES

Descripción del ARCHOS

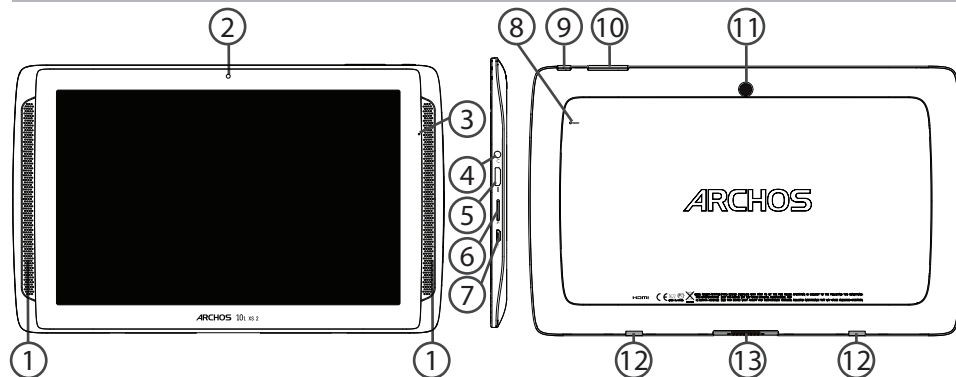

- | | | | |
|-----------------------|-------------------------------|----------------------|----------------------|
| ① Altavoces | ⑤ Salida de video mini-HDMI* | ⑨ Botón ON/OFF | ⑬ Puerto propietario |
| ② Webcam | ⑥ Lector de tarjetas micro-SD | ⑩ Botones de volumen | |
| ③ Indicador de carga | ⑦ Puerto micro-USB | ⑪ Cámara | |
| ④ Toma de auriculares | ⑧ Restablecimiento del equipo | ⑫ Imanes de sujeción | |

* Con un cable de vídeo opcional (HDMI / Mini-HDMI).



Asistente de inicio

La primera vez que encienda el ARCHOS, el asistente de instalación le ayudará a configurar el dispositivo :

- Idioma
- Fecha y hora
- Conexión WiFi
- El servicio de ubicación
- Aplicaciones de terceras partes

ES

CONSEJOS:

Definir los parámetros de su dispositivo en el área de la red WiFi que usted será regularmente usando.



Conexión WiFi

ADVERTENCIA: Asegúrese de que se encuentra en una zona WiFi.

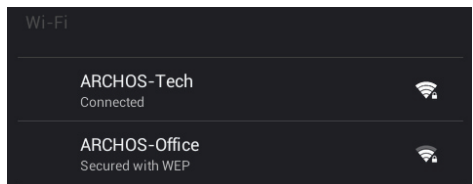

- ① Mantenga pulsados los iconos de reloj y batería para mostrar la barra de estado. Aparecerá una franja azul.
- ② Arrastre la franja azul hacia abajo para mostrar el panel de estado.
- ③ Pulse "Wi-Fi off [Desactivar WiFi]" en el panel de estado. Aparecerá la página WiFi.
- ④ Si el sistema WiFi está desactivado, deslice el interruptor WiFi para ajustarlo en la posición "ON".
- ⑤ Una vez activado el sistema WiFi, el ARCHOS buscará redes WiFi que se encuentren dentro de su alcance. Toque el nombre de la red a la que desee conectarse.

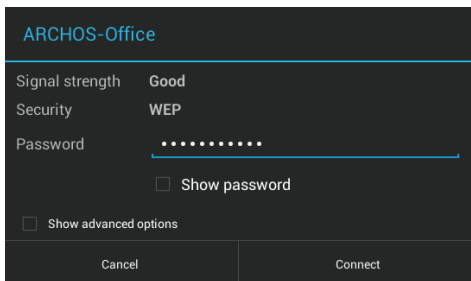

Las redes privadas se muestran con un icono de candado y será preciso que introduzca su contraseña.

CONSEJOS:

- Al introducir una contraseña WiFi, se recomienda que seleccione "Mostrar contraseña". Para obtener la contraseña (o los ajustes) WiFi correcta para la red, póngase en contacto con el proveedor de la red WiFi. Si su sistema WiFi se activa y se encuentra dentro del alcance de una red a la que se haya conectado anteriormente, el ARCHOS intentará automáticamente conectarse a ella.
- Para mantener la conexión WiFi activada con el dispositivo en reposo, seleccione el icono Menú en la página "WiFi". Luego, seleccione Advanced > Keep WiFi on during sleep > Always [Avanzado > Mantener WiFi activo durante el periodo de reposo > Siempre].

El Interfaz Android™





- ① **Google™ Search**
> Toque para búsqueda de texto o busque por voz .
- ② **Aplicaciones Android™**
> Toque para iniciar una aplicación.
- ③ **Acceso directo permanente a aplicaciones Android™**
- ④ **"Volver"**
- ⑤ **"Inicio"**
- ⑥ **"Aplicaciones recientes"**
- ⑦ **"Todas las aplicaciones"**
> Toque este icono para mostrar todas las aplicaciones y widgets instalados en el ARCHOS. Todas las aplicaciones descargadas se encuentran aquí.
- ⑧ **Barra de estado**
> Muestra notificaciones y ajustes rápidos.

El Interfaz Android™

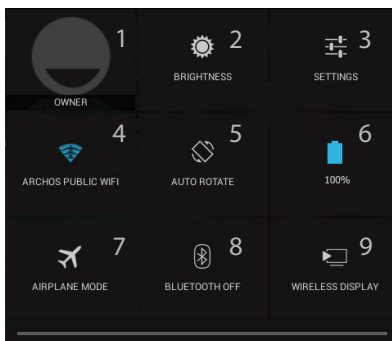

Los ajustes rápidos

- 1 Usuario actual⁽¹⁾
- 2 Para ajustar el brillo de la pantalla.
- 3 Para acceder a todos los ajustes.
- 4 Para activar/desactivar la conexión WiFi.
- 5 Para activar/desactivar la orientación automática de la pantalla al girar el ARCHOS.
- 6 Porcentaje de batería restante
- 7 Para activar/desactivar todas las conexiones inalámbricas, especialmente al volar.
- 8 Para activar/desactivar la conexión Bluetooth.
- 9 Para habilitar la visualización inalámbrica⁽²⁾

⁽¹⁾El nuevo soporte multiusuario para tabletas permite que distintos usuarios tengan sus propios espacios personalizables e independientes en un único dispositivo. Añada usuarios en Settings > Device [Ajustes > Dispositivo].

⁽²⁾Puede compartir películas, vídeos de YouTube y cualquier cosa que aparezca en pantalla en un televisor HD. Deberá conectar un adaptador de pantalla inalámbrico a su televisor habilitado HDMI para reflejar lo que aparece en pantalla de forma rápida y sencilla.



Aplicaciones recientes

Abre una lista de imágenes en miniatura de las aplicaciones con las que haya trabajado recientemente:

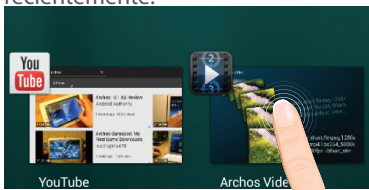

Tocar: para abrir una aplicación.

Mantener pulsado: para mostrar opciones

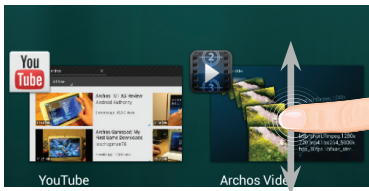

Mover el dedo arriba o abajo: para cerrar una aplicación.



Para familiarizarse con Android™

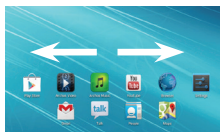

La pantalla de inicio ampliada:

Desplácese entre distintos paneles de la pantalla de inicio deslizando el dedo a la izquierda y la derecha.

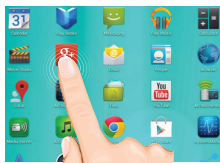

Desplazamiento de un elemento de la pantalla de inicio:

Mantenga el dedo sobre él hasta que aparezcan líneas de cuadrícula de posición; a continuación, deslícelo hasta la ubicación deseada y suelte el dedo.

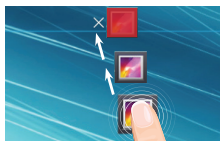

Eliminación de un elemento de la pantalla de inicio:

Mantenga el dedo sobre él, deslice el dedo hacia la parte superior de la pantalla y déjelo caer sobre el icono "Eliminar."



Desinstalación de un elemento:

En las pantallas Todas las aplicaciones, mantenga el dedo sobre él, deslice el dedo hacia la parte superior de la pantalla y déjelo caer sobre la papelera "Desinstalar".



Creación de carpetas de aplicaciones:

Deje caer un icono de aplicación sobre otro en una pantalla de inicio y los dos iconos se combinarán.



Widgets:

Toque el icono de todas las aplicaciones en la pantalla de inicio. Toque "Widgets" en la parte superior de la pantalla. En la pantalla "Widgets" principal, puede desplazarse de un widget a otro de la misma manera que lo hace para los iconos de aplicaciones.

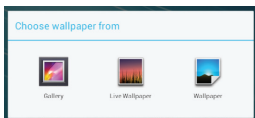

Cambio del fondo:

Mantenga el dedo en la pantalla en una ubicación vacía y, a continuación, elija en la lista.

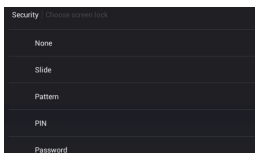

Bloqueo de la pantalla táctil:

En el escritorio digital de ajustes rápidos de la barra de estado, toque ajustes. Desplácese hacia abajo y toque "Seguridad" > "Bloqueo de la pantalla". Toque el tipo de bloqueo que desee utilizar. Tras definir aquí un bloqueo, aparecerá una pantalla de bloqueo cuando se active la pantalla, solicitando el patrón, PIN u otra clave especificada.



Uso del teclado

El ARCHOS 101 XS 2 está equipado con un sensor de efecto Hall. Cuando se cubra el dispositivo con su coverboard, la pantalla se apaga automáticamente. La pantalla se enciende cuando usted levanta la coverboard.

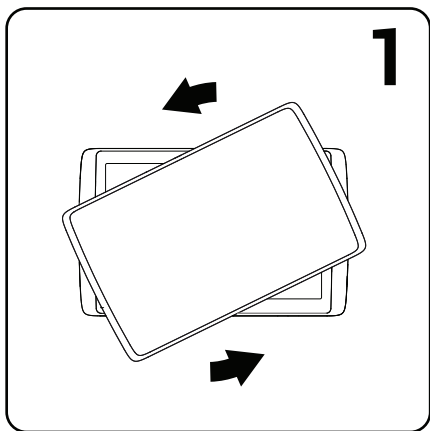

1. Gire la tablet para separarla del teclado y levantarla.

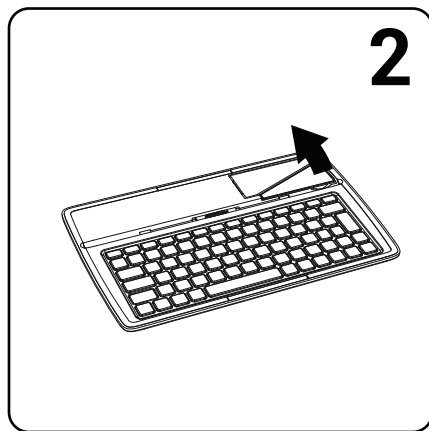

2. Levante el soporte y pliéguelo.



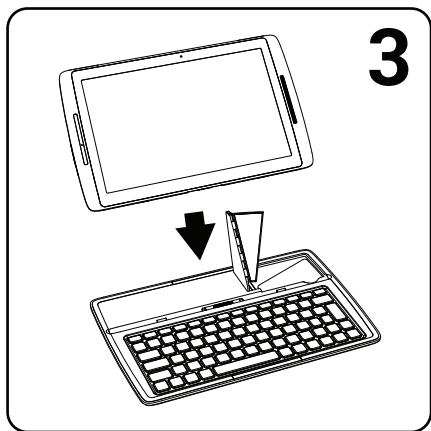

3. Acomode la tableta en su ubicación.

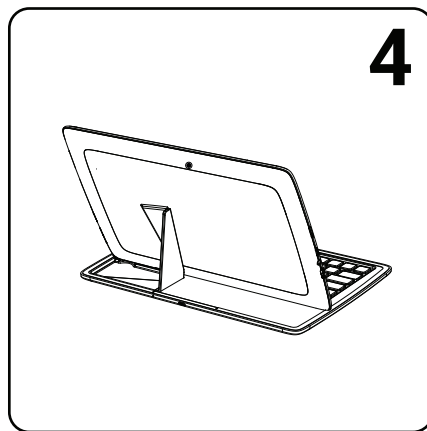

Vista trasera de la tablet ubicada en el teclado.



Solución de problemas

Si el dispositivo se bloquea:

Pulse el botón ON/OFF durante 10 segundos.

Si el dispositivo no se enciende:

1. Cargue el dispositivo.
2. Pulse el botón ON/OFF durante 10 segundos.

Si el dispositivo está completamente descargado

Cargue su dispositivo por lo menos 10 minutos antes de que se encienda.

Si desea aumentar la duración de la batería:

Disminuya el brillo de la pantalla y desactive las conexiones inalámbricas si no las utiliza.

Si el dispositivo funciona con demasiada lentitud:

Cierre todas las aplicaciones que no esté utilizando.

Si la recepción WiFi es demasiado baja:

Asegúrese de que no se encuentra lejos de la zona activa WiFi.

Actualizar el firmware del dispositivo: <http://www.archos.com/support>.

Restablecer la configuración de su conexión.

Póngase en contacto con el proveedor de la conexión WiFi.

Si desea restaurar el producto (ha olvidado la contraseña o quiere borrar todos sus parámetros) :

1. Mantenga volumen+ y conecte el cable de alimentación al puerto de ARCHOS (USB o de alimentación).
 2. Una vez que aparezca el robot verde ANDROID, suelte el botón de volumen+.
 3. Mantenga pulsado el botón ON / OFF y pulse el botón de volumen+.
- Se muestra el sistema de recuperación de Android.
4. Utilice los botones de Volumen para desplazarse y el botón ON/OFF para confirmar una opción.
 - Seleccione "Wipe data/factory reset" [Borrar datos/configuración de fábrica] y confirme.
 - Seleccione "Yes -- delete all user data" [Sí --borrar todos los datos de usuario] y confirme.
 - Seleccione "Reboot system now" [Reiniciar el sistema ahora] y confirme.



Sommario

Contenuto della confezione.....	66
Avvio.....	67
Descrizione del ARCHOS.....	68
Installazione guidata.....	69
Connessione a una rete WiFi	70
L'interfaccia di Android™	72
Conoscere Android™	76
Utilizzare la tastiera.....	78
Soluzione dei problemi.....	80

Per ulteriori informazioni, consultare le FAQ e il manuale utente del vostro prodotto su www.archos.com. Accertarsi di aver letto questo materiale prima di considerare l'eventuale restituzione del prodotto. Il problema riscontrato potrebbe non essere davvero un problema!



Contenuto della confezione

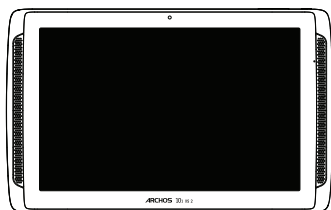

ARCHOS 101 XS 2

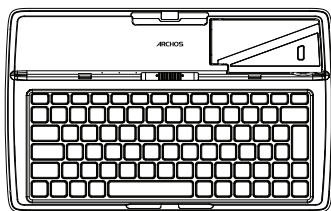

ARCHOS 101 XS 2 tastiera



Guida dell'utente



Garanzia, note legali
e sulla sicurezza



Cavo USB

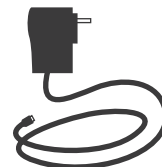

Caricatore

Avvio

Caricamento della batteria

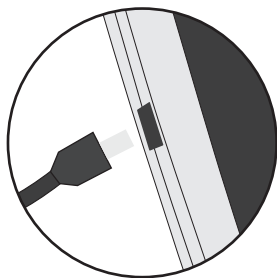

Caricare il dispositivo collegando il cavo di alimentazione nella porta micro-USB. Il dispositivo ARCHOS si accenderà e inizierà a ricaricarsi. Mentre la batteria si ricarica, la spia dell'indicatore di ricarica è accesa

- Durante il caricamento è possibile usare ARCHOS.
- Caricare completamente il dispositivo al primo utilizzo.
- Utilizzare solo il caricabatteria incluso.

Quando il tuo dispositivo è completamente scarico, devi caricarlo per almeno 10 minuti prima che possa essere visualizzata l'icona di ricarica della batteria.

CONSIGLI:

Per ricevere un'assistenza più completa, registrare il prodotto.
Con un computer, andare su www.archos.com/register.

Descrizione del ARCHOS

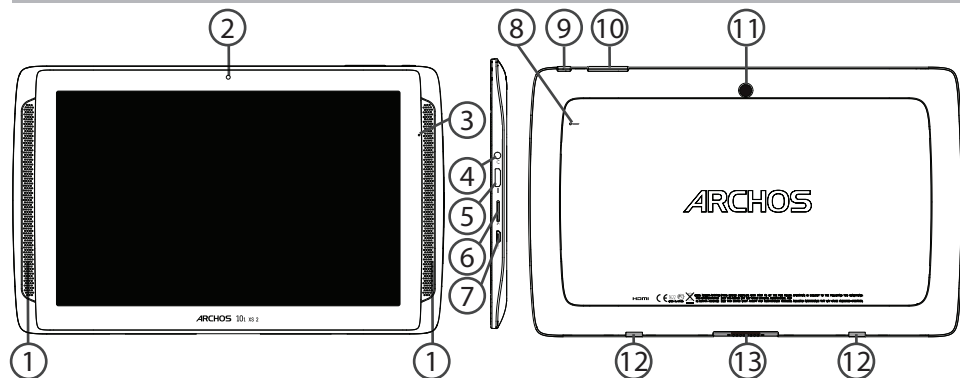

① Altoparlante

② Webcam

③ Indicatore della ricarica

④ Spinotto cuffie

⑤ Uscita video mini HDMI*

⑥ Lettore di schede micro SD

⑦ Porta micro-USB

⑧ Ripristino hardware

⑨ Pulsante ON/OFF

⑩ Tasti volume

⑪ Camera

⑫ Magneti di sostegno

⑬ Porta proprietaria

* Con cavo video opzionale (HDMI / mini HDMI).



Installazione guidata

La prima volta che si avvia ARCHOS, il wizard di installazione aiuterà ad installare il dispositivo :

- Lingua
- Data e ora
- Connessione WiFi
- Il servizio di localizzazione
- Applicazioni di altri produttori

IT

CONSIGLI:

Definire i parametri del dispositivo nella zona della rete WiFi si utilizzano regolarmente.



Connessione a una rete wireless

ATTENZIONE: Accertarsi di essere in una zona coperta da WiFi.

-  ① Tocca e tieni premute le icone dell'orologio e della batteria per visualizzare la barra di stato. Viene visualizzata una linea blu.
-  ② Trascina la linea blu verso il basso per visualizzare il dashboard di stato.
-  ③ Tocca "WiFi off" nel dashboard di stato. Verrà visualizzata la pagina WiFi.
-  ④ Se la rete WiFi è disattivata, spostare il pulsante WiFi sulla posizione "ON".
-  ⑤ Una volta attivata la rete WiFi, ARCHOS scansionerà le reti WiFi presenti. Selezionare il nome di rete a cui si desidera connettersi.

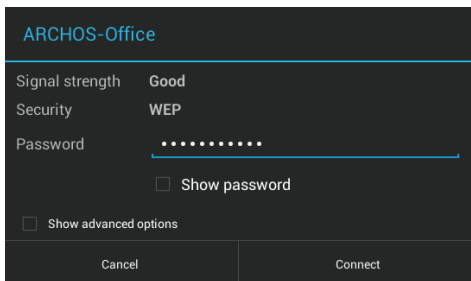

Le reti private vengono visualizzate con un lucchetto e richiedono l'inserimento di una password.

CONSIGLI:

- Quando si inserisce una password WiFi, si consiglia di selezionare «Visualizza password». Per ottenere la password (impostazioni) WiFi corretta per la rete, contattare il fornitore della rete WiFi. Se la rete WiFi è attiva e ci si trova all'interno di una rete precedentemente utilizzata, il vostro ARCHOS automaticamente tenterà di collegarsi nuovamente alla stessa rete.
- Per mantenere attiva (ON) la connessione WiFi quando il dispositivo è in modalità sleep, seleziona l'icona Menu nella pagina "WiFi". Poi seleziona Advanced > Keep WiFi on during sleep > Always [Avanzate > Mantieni attivo il WiFi in modalità sleep > Sempre].

Interfaccia Android™





- ① **Google™ Search**
> Selezionare la ricerca per testo o per voce.
- ② **Applicazioni Android™**
> Selezionare per avviare un'applicazione.
- ③ **Icone permanenti di accesso rapido alle app Android™**
- ④ **"Indietro"**
- ⑤ **"Home"**
- ⑥ **"Applicazioni recenti"**
- ⑦ **"Tutte le applicazioni"**
> Selezionare questa icona per visualizzare tutte le applicazioni e i widget si accenderanno sul vostro ARCHOS. Tutte le applicazioni scaricate sono qui.
- ⑧ **Barra di stato**
> Che visualizza le notifiche e le impostazioni rapide.



Interfaccia Android™

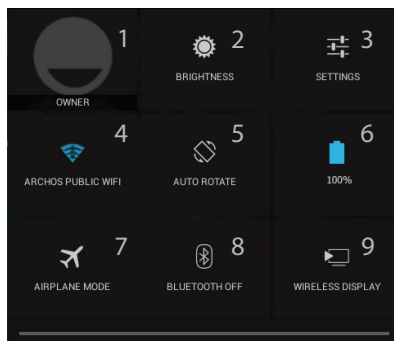

Impostazioni rapide

- 1 Utente corrente⁽¹⁾
- 2 Per regolare la luminosità dello schermo.
- 3 Per accedere a tutte le impostazioni.
- 4 Per attivare/disattivare la connessione WiFi.
- 5 Per attivare/disattivare l'orientamento automatico dello schermo mentre si ruota ARCHOS .
- 6 Percentuale di batteria rimasta
- 7 Per attivare/disattivare tutte le connessioni wireless, specialmente in volo.
- 8 Per attivare/disattivare la connessione Bluetoothj.
- 9 Per attivare il display wireless⁽²⁾

⁽¹⁾Il nuovo supporto multi-utente per i tablet permette a utenti diversi di avere ciascuno il proprio spazio distinto e personalizzabile su un singolo dispositivo. Puoi aggiungere utenti in Settings > Device [Impostazioni > Dispositivo].

⁽²⁾Puoi condividere film, filmati di YouTube e tutto ciò che vedi sullo schermo su un televisore HDTV. Per ritrasmettere il contenuto del tuo schermo in modo semplice e veloce, devi collegare un adattatore display wireless a una qualsiasi TV abilitata HDMI



Applicazioni recenti

Apri un elenco di immagini in miniatura delle applicazioni su cui si è recentemente lavorato:

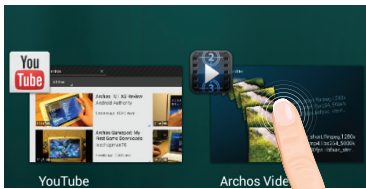

Tocca: per aprire una app.

Tieni premuto: visualizza le opzioni

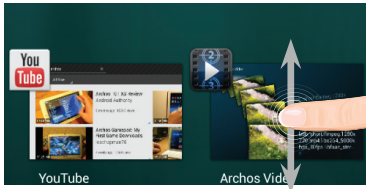

Scorri verso l'alto o il basso: chiudi un'app.



Conoscere Android™



Schermata iniziale estesa:

Navigare tra i vari pannelli della schermata iniziale sfiorando da sinistra o destra.



Spostare una voce della schermata iniziale:

Selezionare e tenere il dito su di essa fino a quando si visualizzano le linee della griglia di posizionamento, quindi scorrere nella posizione desiderata e togliere il dito.

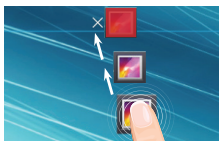

Rimuovere una voce della schermata iniziale:

Selezionare e tenerla, scorrere il dito verso la parte superiore dello schermo e lasciare sull'icona "Rimuovi".



Disinstallare una voce:

Dalle schermate Tutte le applicazioni, selezionare e tenere, scorrere il dito verso la parte superiore dello schermo e lasciare su "Cestino disinstalla".



Creare cartelle di applicazioni:

Lasciare un'icona di applicazione su un'altra icona della schermata iniziale e le due icone si combineranno.



Widget:

Selezionare l'icona "Tutte le applicazioni" della schermata iniziale. Toccare i "Widget" sulla parte superiore dello schermo. Dalla schermata principale Widget, è possibile spostare i widget proprio come si fa per le icone delle applicazioni.

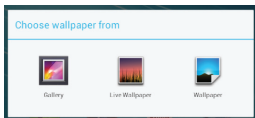

Modificare lo sfondo:

Tenere il dito sulla schermata su una posizione vuota, quindi selezionare dall'elenco.

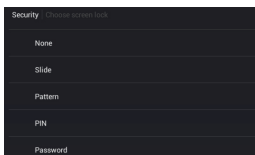

Blocco del touchscreen:

Dal pannello delle impostazioni rapide nella barra di stato, selezionare impostazioni. Scorrere e selezionare "Protezione" > "Bloccare il touchscreen". Selezionare il tipo di blocco che si desidera usare. Dopo aver impostato un blocco, un lucchetto viene visualizzato ogni volta che lo schermo si apre, richiedendo sequenza, PIN o altra chiave specificata.



Utilizzare la tastiera

Il ARCHOS 101 XS 2 è dotato di un sensore ad effetto Hall. Quando si copre il dispositivo con il suo coverboard, lo schermo si spegne automaticamente. Lo schermo si accende quando si solleva il coverboard.

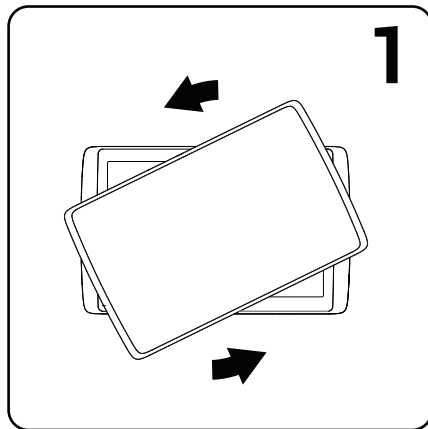

1. Fate ruotare la tavoletta per separarsi lei dalla tastiera e sollevatela.

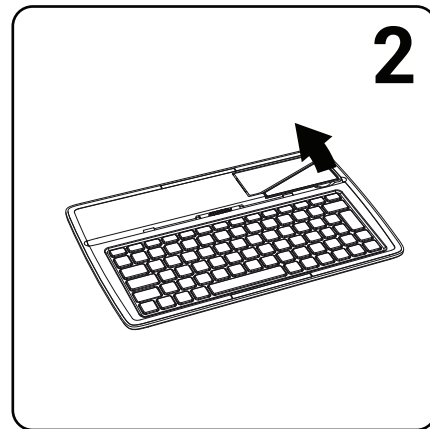

2. Sollevate la stampella e piegatela.



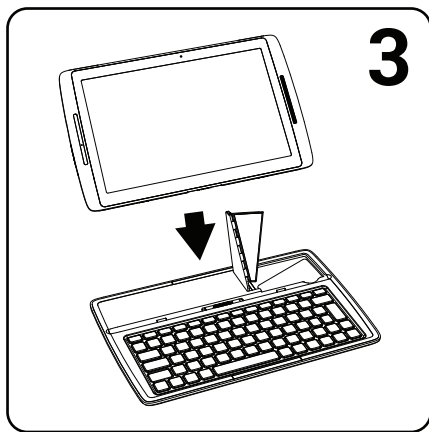

3. Ponete la tavoletta sulla sua area.

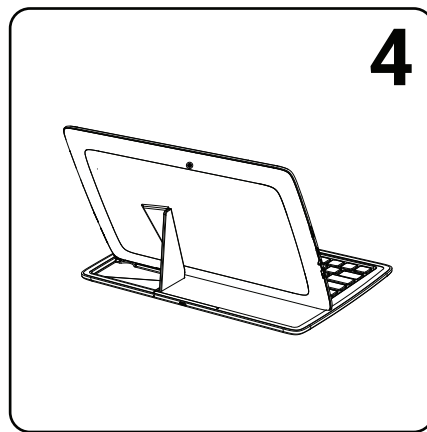

Vista posteriore della tavoletta posta sulla tastiera.



Soluzione dei problemi

Nel caso in cui il dispositivo sembri bloccato:

Premere il pulsante ON/OFF per 10 secondi.

Nel caso in cui il dispositivo non si accenda:

1. Caricare il dispositivo.
2. Premere il pulsante ON/OFF per 10 secondi.

Se il dispositivo è completamente scarica

Caricare il dispositivo per almeno 10 minuti prima che si accenda.

Se si desidera estendere la vita della batteria:

Diminuire la luminosità dello schermo e spegnere le connessioni wireless non in uso.

Se il dispositivo funziona troppo lentamente:

Chiudere tutte le applicazioni non attualmente in uso.

Se la ricezione WiFi è troppo lenta:

Accertarsi di non essere troppo lontani dal punto WiFi.

Aggiornare il firmware del dispositivo: <http://www.archos.com/support>.

Ripristinare le impostazioni di connessione.

Contattare il fornitore della connessione WiFi.

Se si desidera ripristinare il prodotto (password dimenticata? cancellare tutte le impostazioni?):

1. Tenere premuto Volume+ e collegare il cavo di alimentazione fornito al dispositivo ARCHOS e a una presa a muro.
2. Il verde robot Android viene visualizzato. Rilasciare il pulsante del volume+.
3. Tenere premuto il tasto ON / OFF e premere il tasto volume+.
Il ripristino del sistema Android è visualizzato.
4. Utilizzare i pulsanti del Volume per scorrere e il pulsante ON/OFF per confermare.
 - Selezionare "Wipe data/factory reset" e confermare.
 - Selezionare "Yes -- delete all user data" e confermare.
 - Selezionare "Reboot system now" e confermare.



Inhoudsopgave

Wat zit er in de doos?.....	82
Aan de slag.....	83
Beschrijving ARCHOS.....	84
Installatiewizard.....	85
WiFi-netwerkverbinding.....	86
De Android™-Interface.....	88
Vertrouwd raken met Android™	92
Gebruik van uw toetsenbord.....	94
Problemen oplossen.....	96

NL

Raadpleeg voor meer informatie de veelgestelde vragen (FAQ's) en de handleiding van uw product op www.archos.com. Zorg ervoor dat u ze leest alvorens te overwegen het product te retourneren. Uw probleem kan wel eens een probleempje blijken.



Wat zit er in de doos?

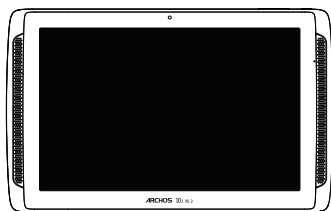

ARCHOS 101 XS 2

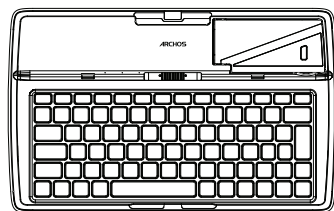

ARCHOS 101 XS 2 toetsenbord



Gebruikershandleiding



Garantie, wettelijke mededelingen en veiligheidsvoorschriften



USB-kabel

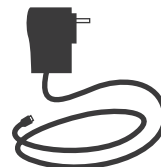

Lader

Aan de slag

De batterijen laden

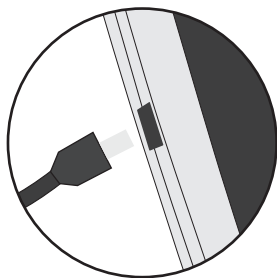

Laad uw apparaat op door de stekker van uw voedingskabel in de micro USB-poort te steken. Het ARCHOS-apparaat start op en begint op te laden. Het laadcontrolelampje brandt wanneer de batterij aan het opladen is.

- U kunt uw ARCHOS gebruiken terwijl hij wordt opgeladen.
- Laad het apparaat de eerste keer helemaal op.
- Gebruik uitsluitend de meegeleverde oplader.

Als u uw apparaat gaat opladen met een lege batterij, dan duurt het ten minste 10 minuten voordat het batterijpictogram wordt weergegeven.

TIPS:

Registreer uw product om de volledige service te ontvangen.
Als u een computer hebt, ga dan naar www.archos.com/register.

Beschrijving ARCHOS

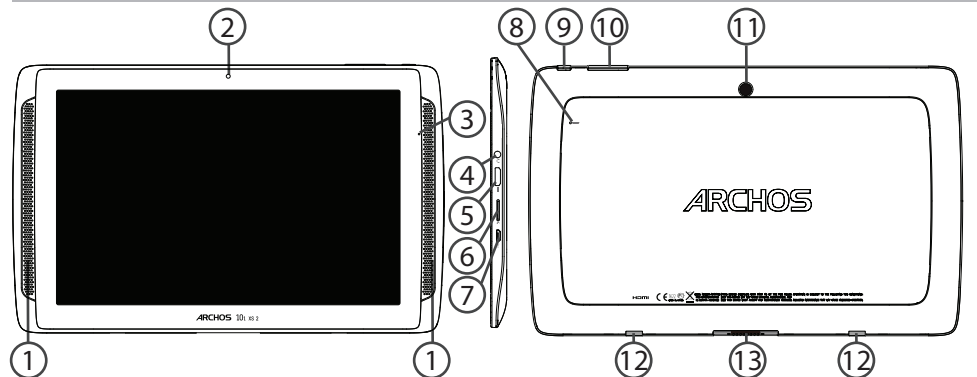

- ① Luidsprekers
- ② Webcam
- ③ Laadindicator
- ④ Hoofdtelefoonaansluiting
- ⑤ Mini-HDMI-video-uitgang*
- ⑥ Micro-SD-kaartlezer
- ⑦ Micro USB-poort
- ⑧ Het toestel resetten
- ⑨ AAN/UIT-knop
- ⑩ Volumeknoppen
- ⑪ Camera
- ⑫ Magneten
- ⑬ Proprietary poort

* Optionele videokabel (HDMI / mini-HDMI) afzonderlijk te koop.



Installatiewizard

De eerste keer dat u uw ARCHOS inschakelt, zal de installatiewizard u helpen bij het instellen van uw apparaat :

- Taal
- Datum en tijd
- WiFi-verbinding
- De locatieservice
- Toepassingen van derden

NL

TIPS:

Definieer de parameters van het apparaat op het gebied van het WiFi-netwerk zult u regelmatig gebruikt.

WiFi-netwerkverbinding

WAARSCHUWING: Zorg ervoor dat u zich in een WiFi-zone bevindt.

-  ① Houd uw vingers op de pictogrammen voor de tijd en de batterij om de statusbalk weer te geven. Er wordt een blauwe streep weergegeven.
-  ② Sleep de blauwe streep naar beneden om de statusinformatie weer te geven.
-  ③ Tik op "WiFi off" [WiFi uit] in de statusinformatie. De WiFi-pagina wordt weergegeven.
-  ④ Als de WiFi is uitgeschakeld, schuift u de WiFi-schakelaar in de stand "AAN".
-  ⑤ Zodra de WiFi is ingeschakeld, gaat de ARCHOS zoeken naar WiFi-netwerken die zich binnen het bereik bevinden. Tik op de naam van het netwerk waarmee u verbinding wilt maken.

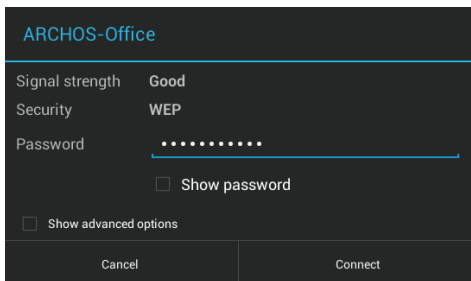

Privé-netwerken worden weergegeven met een slotje en vragen u om uw wachtwoord in te voeren.

NL

TIPS:

- Bij het invoeren van een WiFi-wachtwoord, raden wij u aan «Wachtwoord weergeven» te selecteren, zodat u de tekens kunt zien die u aan het typen bent. Neem voor het juiste WiFi-wachtwoord (of instellingen) voor het netwerk contact op met de WiFi-netwerkprovider. Als uw WiFi is ingeschakeld en u zich binnen het bereik van een netwerk bevindt waarmee u al eerder verbinding hebt gemaakt, zal ARCHOS automatisch proberen er opnieuw verbinding mee te maken.
- Om uw WiFi-verbinding ingeschakeld te houden als het apparaat in stand-by is, selecteert u het Menu-pictogram op de WiFi-pagina. Vervolgens selecteert u Advanced > Keep WiFi on during sleep > Always [Geavanceerd > WiFi aan in stand-by > Altijd].

De Android™-Interface



-
- ① **Google™ Search**
> Tik voor zoeken op tekst of zoeken met stem .
 - ② **Android™-apps**
> Tik erop om een applicatie te starten.
 - ③ **Snelkoppelingen van permanente Android™-apps**
 - ④ **Recente apps**
 - ⑤ **Startpagina**
 - ⑥ **Terug**
 - ⑦ **"Knop Alle Apps"**
> Tik op dit pictogram om alle applicaties en widgets weer te geven die op uw ARCHOS zijn geïnstalleerd. Al uw gedownloade applicaties bevinden zich hier.
 - ⑧ **Statusbalk**
> Geeft meldingen en snelinstellingen weer.

De Android™-Interface

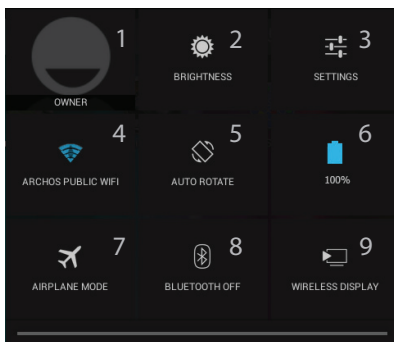

De Snelinstellingen

- 1 Huidige gebruiker⁽¹⁾
- 2 Om de helderheid van het scherm aan te passen.
- 3 Om al uw instellingen te openen.
- 4 Om uw WiFi-verbinding aan/uit te zetten.
- 5 Om de automatische oriëntatie van het scherm te activeren/deactiveren als u uw ARCHOS draait.
- 6 Percentage batterijlading
- 7 Om alle draadloze verbindingen te activeren/deactiveren, in het bijzonder tijdens het vliegen.
- 8 Om uw Bluetooth-verbinding aan/uit te zetten.
- 9 Per attivare il display wireless⁽²⁾

⁽¹⁾Nieuwe tabletondersteuning voor meerdere gebruikers waarbij iedere gebruiker zijn eigen ruimte op de tablet kan maken en aanpassen. Voeg gebruikers toe bij Settings > Device [Instellingen > Apparaat]

⁽²⁾Puoi condividere film, filmati di YouTube e tutto ciò che vedi sullo schermo su un televisore HDTV. Per ritrasmettere il contenuto del tuo schermo in modo semplice e veloce, devi collegare un adattatore display wireless a una qualsiasi TV abilitata HDMI.



Recente apps

Hiermee opent u een lijst van miniatuurafbeeldingen van apps waarmee u onlangs hebt gewerkt:

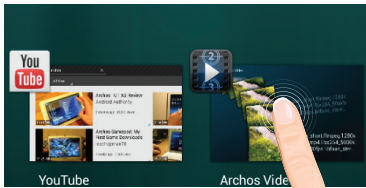

Aanraken: een app openen.

Vasthouden: opties weergeven

NL

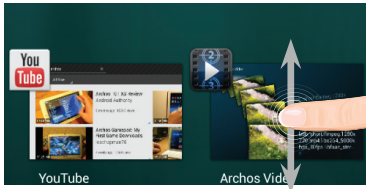

Op en neer vegen: een app sluiten.



Vertrouwd raken met Android™



Het uitgebreide startscherm:

Navigeren tussen de verschillende startschermpanelen door er van links en rechts overheen te vegen.

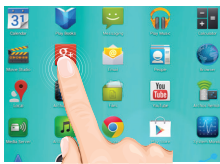

Het verplaatsen van een item op het startscherm:

Tik en houd uw vinger op zijn plaats tot de positioneringsrasterlijnen verschijnen, dan schuift u deze naar de gewenste locatie en laat uw vinger vervolgens weer los.

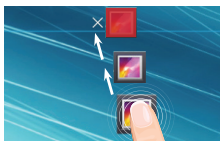

Het verwijderen van een item op het startscherm:

Tik en houd uw vinger op het item en schuif dit vervolgens naar de bovenkant van het scherm en zet het op het pictogram "Verwijderen".



Verwijderen van een item:

Tik in de schermen Alle apps op het item en houd uw vinger daar, schuif vervolgens uw vinger in de richting van de bovenkant van het scherm en plaats het item op de prullenbak "Verwijderen".



Het aanmaken van applicatiemappen:

Plaats op een startscherm het ene app-pictogram op het andere, en de twee pictogrammen worden gecombineerd.



Widgets:

Tik in uw startscherm op het pictogram "Alle apps". Tik op "Widgets" aan de bovenkant van het scherm. Vanaf het Widgets-hoofdscherm kunt u widgets op dezelfde manier verplaatsen als app-pictogrammen.

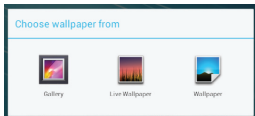

Uw wallpaper wijzigen:

Houd uw vinger op het scherm op een lege plek en maak vervolgens een selectie uit de lijst.

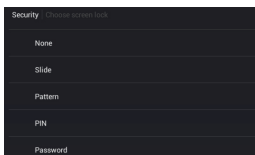

Het vergrendelen van het aanraakscherm:

Tik vanuit het snelinstellingen-dashboard op instellingen. Scroll naar beneden en tik op veiligheid. Tik op "Scherm vergrendelen". Tik op het type slot dat u wilt gebruiken. Nadat u hier een slot hebt ingesteld, wordt er een vergrendelscherm weergegeven wanneer uw scherm 'wakker' wordt, dat om het patroon, de PIN of een andere specifieke toets vraagt.



Gebruik van uw toetsenbord

De ARCHOS 101 XS 2 is uitgerust met een Hall-effect sensor. Wanneer u bedekken het apparaat met zijn coverboard, wordt het scherm automatisch uitgeschakeld. Het scherm wordt ingeschakeld wanneer u de coverboard tillen.

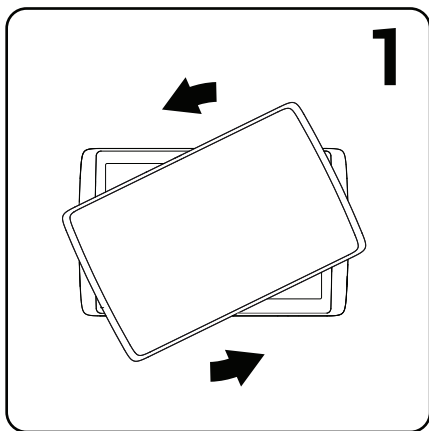

1. Draai en til de tablet.

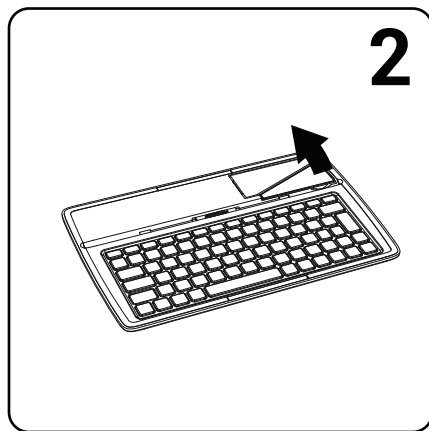

2. Til en vouw de tablet stand.



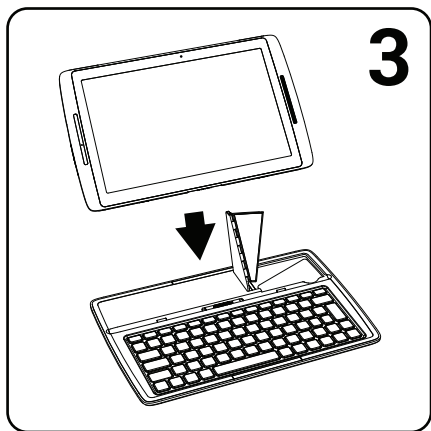

3. Leg de tablet in de aangewezen locatie.

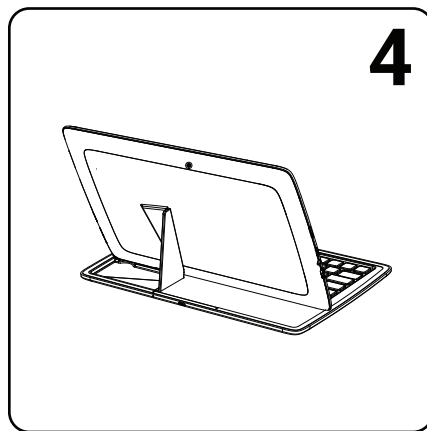

Achteraanzicht van de tablet op het toetsenbord.

NL



Problemen oplossen

Als uw apparaat vast zit:

Druk gedurende 10 seconden op de AAN/UIT-knop.

Als uw apparaat niet inschakelt:

1. Laad uw apparaat op.
2. Druk gedurende 10 seconden op de AAN/UIT-knop.

Als uw apparaat helemaal leeg is

Laad het apparaat ten minste 10 minuten voordat het wordt ingeschakeld.

Als u de levensduur van uw batterij wilt verlengen:

Verminder de helderheid van het scherm en schakel de draadloze verbindingen uit indien deze niet in gebruik zijn.

Als uw apparaat te traag werkt:

Sluit alle applicaties die op dat moment niet worden gebruikt.

Als uw WiFi-ontvangst te laag is:

Zorg ervoor dat u zich niet ver van de WiFi-hotspot bevindt. Update de firmware van het apparaat: <http://www.archos.com/support>. Reset de instellingen van uw WLAN-verbinding. Neem contact op met uw WiFi-verbindingsprovider.

Het product herstellen (wachtwoord vergeten? alle instellingen wissen?):

1. Houd Volume+ en sluit de meegeleverde voedingskabel aan op de ARCHOS en in een stopcontact.
2. De groene robot ANDROID wordt weergegeven. Laat de volume +.
3. Houd de AAN / UIT knop en druk op de volume+ knop.
De Android systeemherstel wordt weergegeven.
4. Gebruik de volumeknoppen om te bladeren en de AAN/UIT-knop om te bevestigen.
 - Selecteer "Wipe data/factory reset" [Gegevens wissen/Fabrieksinstellingen herstellen] en bevestig.
 - Select "Yes -- delete all user data" [Ja, alle gebruikersgegevens wissen] en bevestig.
 - Select "Reboot system now" [Systeem nu opnieuw opstarten] en bevestig.

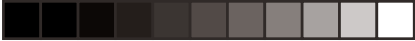

Índice

Conteúdo da embalagem.....	98
Início.....	99
Descrição do ARCHOS.....	100
Assistente de instalação.....	101
Ligação a uma rede WiFi	102
A interface Android™	104
Familiarizar-se com Android™.....	108
Usando o teclado.....	110
Resolução de problemas.....	112

PT

Para obter mais informações, consulte as Perguntas frequentes e o Manual do utilizador do seu produto em www.archos.com. Certifique-se de que os consulta antes de colocar a hipótese de devolver qualquer produto. O seu problema pode ser insignificante.



Conteúdo da embalagem

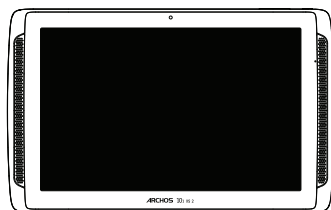

ARCHOS 101 XS 2



Guia do usuário



Garantia, avisos legais e de segurança

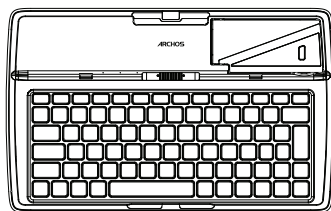

ARCHOS 101 XS 2 teclado



Cabo USB

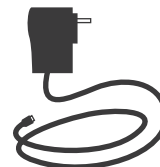

Carregador

Início

Carregar a bateria

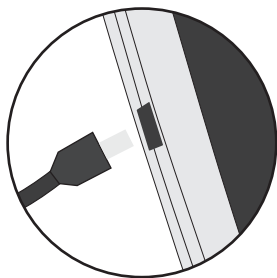

Carregue o seu aparelho ligando o cabo de alimentação à Porta micro-USB. O aparelho ARCHOS irá ligar e será iniciado o carregamento. A luz indicadora de carregamento permanece acesa enquanto a bateria carrega.

- Pode utilizar o seu aparelho ARCHOS enquanto este está a carregar.
- Carregue o dispositivo completamente antes de usá-lo pela primeira vez.
- Use apenas o carregador fornecido.

Quando o teu dispositivo está descarregado por completo, é necessário recarregá-lo pelo menos durante 10 minutos antes de ser exibido o ícone da bateria.

SUGESTÕES:

Para receber uma assistência mais completa, registre o seu produto. No caso de um computador, vá a www.archos.com/register.

PT

Descrição do ARCHOS

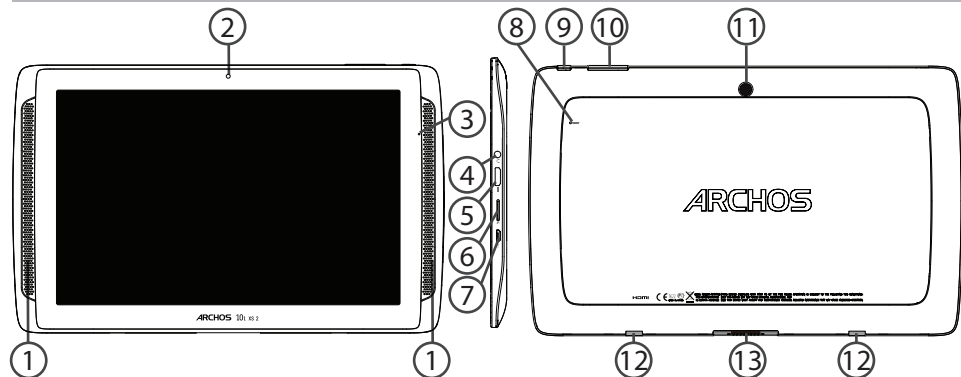

① Colunas

② Webcam

③ Indicador de carga

④ Saída para auriculares

⑤ Saída de vídeo mini-HDMI*

⑥ Slot para cartão micro SD

⑦ Porta micro-USB

⑧ Repor hardware

⑨ Botão Power

⑩ Botões de volume

⑪ Câmera

⑫ Magnetos de suporte

⑬ Porta proprietária

* Com Mini-HDMI opcional para cabo HDMI.



Assistente de instalação

Quando iniciar o ARCHOS pela primeira vez, o assistente de instalação irá ajudá-lo a configurar o seu aparelho :

- Idioma
- Data e hora
- Rede WiFi
- Minha localização
- Aplicações de terceiros

PT





SUGESTÕES:

Definir os parâmetros do seu dispositivo na área da rede WiFi você será regularmente usando.

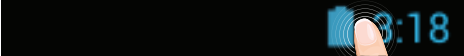

Ligação a uma rede WiFi

AVISO: Certifique-se de que se encontra numa zona WiFi.

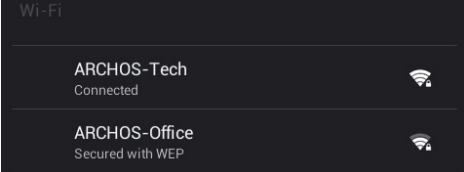
-  ① Toque e mantenha premidos os ícones do Tempo e bateria para revelar a barra de estados. Será exibida uma linha azul.
-  ② Puxe a linha azul para baixo para exibir o painel de controlo.
-  ③ Toque em "Wi-Fi off [Wi-Fi desligado]" no painel de controlo.
-  ④ Será exibida a página do WiFi. Se a funcionalidade WiFi estiver desligada, deslize o computador WiFi para a posição "LIGADO".
-  ⑤ Depois da funcionalidade WiFi estar ligada, o ARCHOS irá procurar redes WiFi ao alcance. Toque no nome da rede à qual pretende ligar-se.

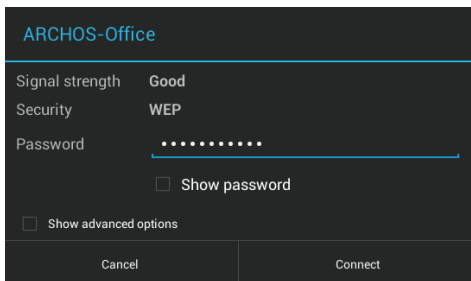

As redes privadas aparecem com o ícone de um cadeado e irão requerer a introdução da sua palavra-passe.

PT

SUGESTÕES:

- Quando introduzir uma palavra-passe WiFi, recomendamos que seleccione “Mostrar palavra-passe” para que possa ver os caracteres que está a digitar. Para obter a palavra-passe (ou definições) WiFi correcta para a rede, contacte a operadora da rede WiFi. Se a sua funcionalidade WiFi estiver ligada e estiver dentro da área de alcance de uma rede à qual já tenha efectuado uma ligação, o seu ARCHOS irá tentar automaticamente ligar-se à mesma.
- Para manter a sua ligação WiFi ligada quando o dispositivo está suspenso, seleccione o ícone do menu na página do WiFi. Em seguida, seleccione Advanced (Avançadas) > Keep WiFi on during sleep [Manter WiFi ligado durante a suspensão] > Always (Sempre)].

A Interface Android™





PT

-
- ① **Google™ Search**
> Toque para efectuar uma pesquisa de texto ou uma busca por voz.
 - ② **Aplicações Android™**
> Toque para iniciar uma aplicação.
 - ③ **Atalhos permanentes em aplicações Android™**
 - ④ **"Aplicações recentes"**
 - ⑤ **"Ecrã Principal"**
 - ⑥ **"Anterior"**
 - ⑦ **"Todas as Aplicações"**
> Toque neste ícone para visualizar todas as aplicações e widgets instalados no seu ARCHOS. Estão aqui todas as aplicações descarregadas.
 - ⑧ **Barra do estado**
> Apresenta notificações e definições rápidas.



A Interface Android™

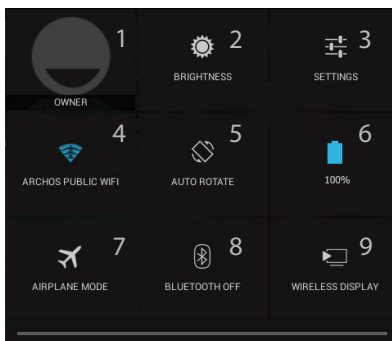

3:18 As Definições rápidas

- 1 Utilizador atual⁽¹⁾
- 2 Para ajustar o brilho do ecrã.
- 3 Para aceder a todas as suas definições.
- 4 Para ligar/desligar a sua ligação WiFi.
- 5 Para activar/desactivar a orientação automática do ecrã enquanto roda o ARCHOS.
- 6 Ver a percentagem de bateria que resta
- 7 Para activar/desactivar todas as ligações sem fios, especialmente durante voos.
- 8 Para ligar/desligar a sua ligação Bluetooth.
- 9 Para ligar a visualização sem fios⁽²⁾.

⁽¹⁾O novo suporte multiutilizador para permite que diferentes utilizadores tenham áreas de trabalho separadas e personalizadas no mesmo dispositivo. Pode adicionar utilizadores em Settings > Device [Definições > Dispositivo]

⁽²⁾Pode partilhar filmes, vídeos do YouTube e tudo o que estiver no seu ecrã com uma televisão HD. Basta que ligue o um adaptador de visualização sem fios numa TV com HDMI e poderá espelhar tudo o que está no ecrã do seu tablet, rápido e facilmente.



Aplicações recentes

Abre uma lista de imagens em tamanho reduzido das aplicações que utilizou recentemente:

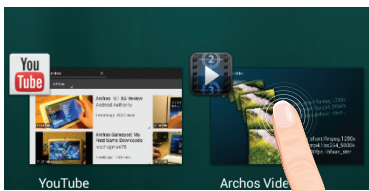

Toque: para abrir uma aplicação

Manter premido: exibir opções

PT

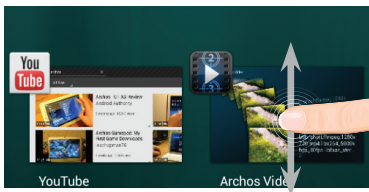

Deslizar para cima ou para baixo: fechar uma aplicação



Familiarizar-se com Android™



O ecrã inicial alargado:

Navegue entre os diferentes painéis do ecrã inicial movendo-os para a esquerda e para a direita.



Mover um item do ecrã inicial:

Toque continuamente com o dedo no mesmo até aparecer a grelha de posicionamento; em seguida, deslize-o para a posição pretendida e solte o dedo.

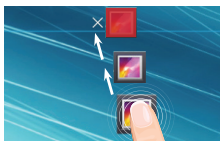

Remover um item do ecrã inicial:

Toque continuamente no mesmo, deslize o seu dedo para o topo do ecrã e largue-o sobre o ícone Remover.



Desinstalar um item:

A partir do ecrã Todas as aplicações, toque continuamente no mesmo, deslize o seu dedo para o topo do ecrã e largue-o sobre o caixote Desinstalar.



Criar pastas de aplicações:

Largue o ícone de uma aplicação sobre outro num ecrã inicial e os dois ícones ficarão combinados.



Widgets:

Toque no ícone Todas as aplicações no seu ecrã inicial. Toque em Widgets no topo do ecrã. A partir do ecrã Widgets principal, pode movimentar os widgets da mesma forma que o faz com os ícones das aplicações.

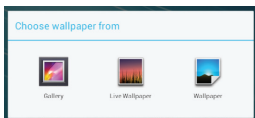

Alterar a imagem de fundo:

Mantenha o dedo no ecrã sobre uma localização vazia, em seguida seleccione a partir da lista.

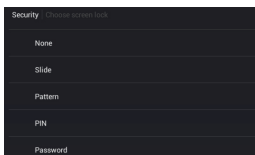

Bloquear o ecrã táctil:

A partir do painel de definições rápidas na barra do estado, toque nas definições. Desloque para baixo e toque em Segurança. Toque em Bloquear ecrã. Toque no tipo de bloqueio que pretende utilizar. Depois de definir aqui um bloqueio, será apresentado um ecrã de bloqueio sempre que activar o ecrã, a solicitar o padrão, o PIN ou outra chave especificada.



Usando o teclado

O ARCHOS 101 XS 2 está equipado com um sensor de efeito Hall. Quando você cubra o aparelho com a sua coverboard, o ecrã desliga-se automaticamente. A tela se acende quando você levantar o coverboard.

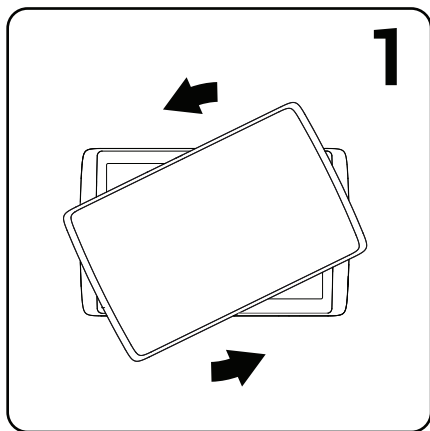

1. Gire e levante o tablet.

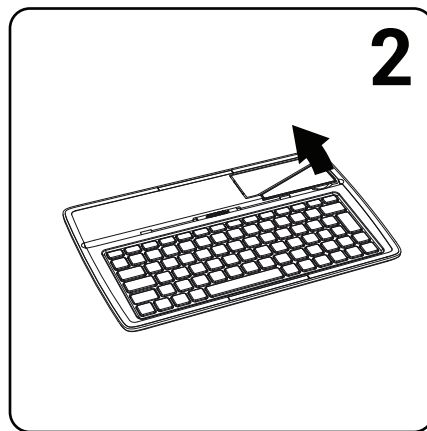

2. Levantar e dobrar a muleta.



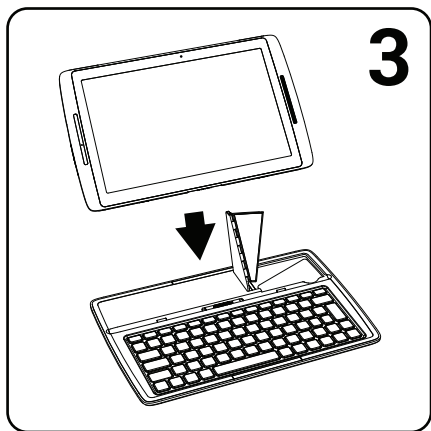

3. Posicione o tablet na sua área.

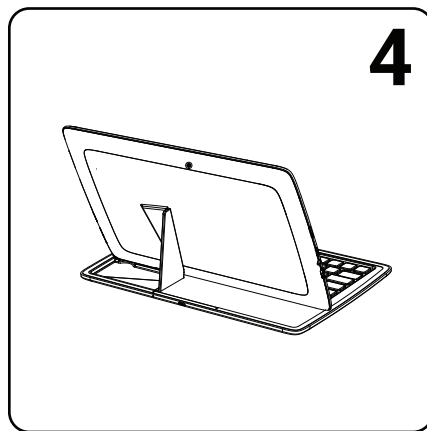

Retrovisor do tablet colocado no teclado.

PT



Resolução de problemas

Se o aparelho bloquear:

Prima o botão LIGAR/DESLIGAR durante 10 segundos.

Se o seu aparelho não ligar:

1. Carregue o aparelho.
2. Prima o botão LIGAR/DESLIGAR durante 10 segundos.

Se o dispositivo estiver totalmente descarregada

Carregue o dispositivo por pelo menos 10 minutos antes de acender.

Se pretender aumentar a autonomia da bateria:

Diminua o brilho do ecrã e desligue as ligações sem fios, se não estiverem a ser utilizadas.

Se o funcionamento do aparelho for demasiado lento:

Encerre todas as aplicações que não estejam a ser utilizadas.

Se a recepção WiFi for demasiado lenta:

Certifique-se de que não está afastado do ponto de ligação WiFi.

Atualizar o firmware do dispositivo: <http://www.archos.com/support>.

Redefinir as configurações de sua conexão.

Contacte a sua operadora da ligação WiFi.

Se quiser restaurar o seu produto (Esqueceu-se da sua palavra-passe? Apagou todas as suas definições?):

1. Mantenha Volume+ e conecte o cabo de alimentação fornecido ao conector de alimentação ARCHOS e para uma tomada de parede.
2. O verde robô Android é exibida. Solte o botão de volume+.
3. Mantenha o botão ON/OFF e pressione o botão de volume+.
A recuperação de sistema Android é apresentado.
4. Utilize os botões de Volume para navegar e o botão LIGAR/DESLIGAR para validade.
 - Escolha "Wipe data/factoryreset" (Apagar tudo/definições de fábrica) e valide.
 - Escolha "Yes -- delete alluser data" (Sim -- Eliminar todos os dados de utilizador) e valide.
 - Escolha "Rebootssystemnow" (Reiniciar o sistema agora) e valide.

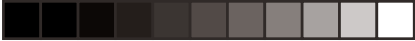

Содержание

Содержимое упаковки	114
Начало работы.....	115
Описание устройства.....	116
Мастер настройки.....	117
Подключение к сети Wi-Fi.....	118
A interface Android™	120
Интерфейс Android™ Знакомство с.....	124
Использование клавиатуры.....	126
Устранение неполадок.....	128

RU

За дополнительно информацией обратитесь к разделу часто задаваемых вопросов и руководству пользователя для Вашего устройства на сайте www.archos.com. Обязательно прочтите их прежде, чем задумываться о возврате изделия. Ваша проблема может оказаться не столь уж значительной.



Содержимое упаковки

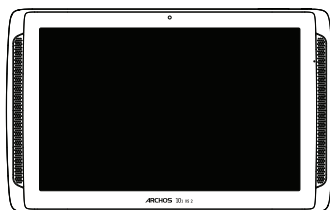

ARCHOS 101 XS 2



Краткое руководство



Гарантии и инструкции
по безопасности

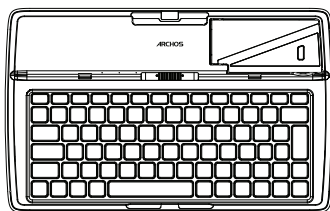

ARCHOS 101 XS 2 клавиатура



Кабель USB

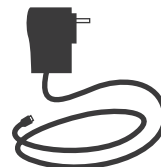

Зарядное устройство

Начало работы

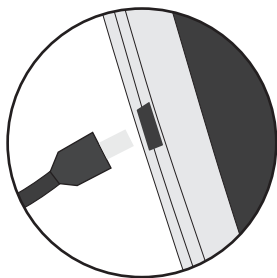

Зарядка

Зарядите Ваше устройство, подключив кабель питания к порту micro-USB. Устройство ARCHOS включится и начнет заряжаться. Во время зарядки батареи светится индикатор заряда.

-Вы можете пользоваться устройством ARCHOS во время зарядки.

-Перед первым использованием устройство должно полностью зарядиться.

-Разрешается использовать только зарядное устройство из комплекта поставки.

Если ваше устройство полностью разрядилось, необходимо зарядить его в течение минимум 10 минут, прежде чем сможет отобразиться значок заряжающегося аккумулятора.

СОВЕТ:

Зарегистрируйте свое изделие, чтобы получать обслуживание в более полном объеме. При работе с компьютером перейдите по ссылке www.archos.com/register.

RU

Описание устройства

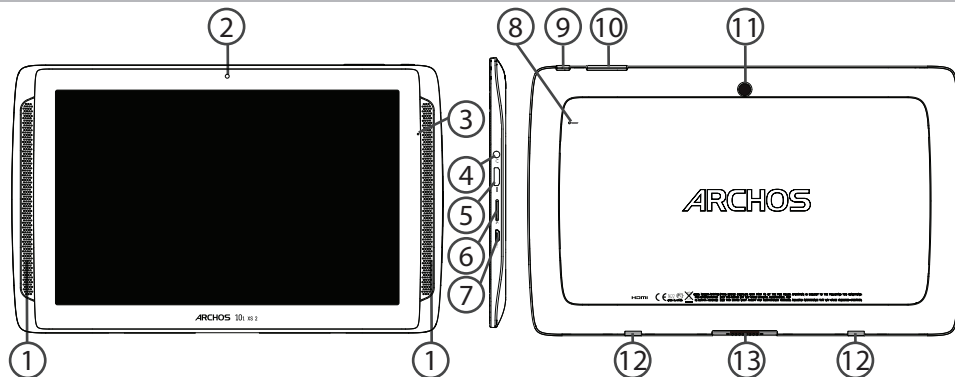

- ① Громкоговорители
- ② веб-камера
- ③ Индикатор заряда
- ④ Гнездо наушников
- ⑤ Видеовыход Mini-HDMI*
- ⑥ Слот для карты Micro-SD
- ⑦ Порт Micro-USB
- ⑧ Индикатор зарядки
- ⑨ Кнопка ВКЛ/ВЫКЛ
- ⑩ Кнопки громкости
- ⑪ Камера
- ⑫ Удерживающие магниты
- ⑬ Проприетарный порт

* С опциональным переходным кабелем Mini-HDMI – HDMI.



Мастер настройки

При первом запуске устройства ARCHOS мастер установки поможет выполнить настройку :

- Язык
- Дата и время
- Соединение Wi-Fi
- Опции службы геолокации
- Сторонние приложения

RU





СОВЕТ:

Мы рекомендуем выполнять настройку устройства в зоне Wi-Fi сети, которой Вы будете регулярно пользоваться.



Подключение к сети Wi-Fi

ВНИМАНИЕ: Убедитесь, что Вы находитесь в зоне покрытия Wi-Fi.

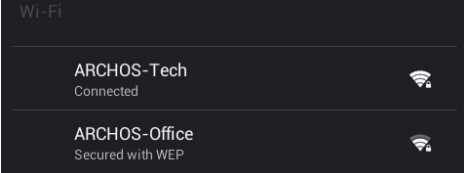
-  ① Коснитесь и удерживайте значки времени и аккумулятора, чтобы открыть строку состояния. Отобразится синяя линия.
-  ② Потяните синюю линию вниз, чтобы отобразить панель мониторинга состояния.
-  ③ Коснитесь пункта «Wi-Fi off [Wi-Fi выкл.]» на панели мониторинга состояния. Отобразится страница Wi-Fi.
-  ④ Если связь Wi-Fi выключена, переместите переключатель Wi-Fi в положение ON (ВКЛ).
-  ⑤ После включения устройство ARCHOS выполнит поиск доступных сетей Wi-Fi. Выберите ту сеть, к которой хотите подключиться.

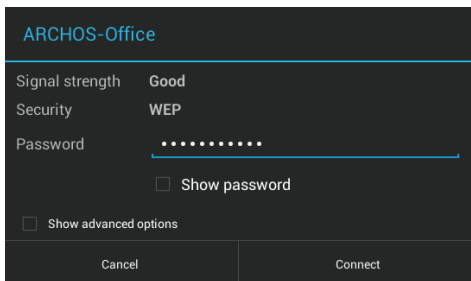

Частные сети отображаются в виде значка с замком, и для них потребуется ввести пароль.

RU

СОБЕТ:

- При вводе пароля рекомендуется выбрать опцию "Show password", чтобы видеть вводимые символы. Для того, чтобы получить сетевой пароль (или настройки) Wi-Fi, обратитесь к провайдеру сети Wi-Fi. Если связь Wi-Fi включена и Вы находитесь в зоне действия сети, к которой ранее подключились, ARCHOS установит соединение автоматически.
- Чтобы поддерживать соединение WiFi включенным, когда устройство находится в спящем режиме, на странице WiFi выберите значок меню. Затем выберите Advanced > Keep WiFi on during sleep > Always [Дополнительно > Оставить WiFi включенным в спящем режиме > Всегда].

Интерфейс Android™





- ① **Поиск Google™**
> Прикоснитесь к позиции «Google», чтобы выполнить тестовый поиск, или к пиктограмме микрофона, чтобы выполнить голосовой поиск.
- ② **Пиктограммы приложений Android™**
> Прикоснитесь к пиктограмме для запуска приложения.
- ③ **Постоянные ярлыки приложений Android™**
- ④ **"Кнопки последних приложений"**
- ⑤ **Кнопка "Домой"**
- ⑥ **Кнопка "Назад"**
- ⑦ **Кнопка "Все приложения"**
> Прикоснитесь к этой пиктограмме, чтобы отобразить все приложения и виджеты, установленные в Вашем ARCHOS. Здесь находятся все загруженные Вами приложения.
- ⑧ **Строка состояния**
> Отображаются сообщения и быстрые настройки.



Интерфейс Android™

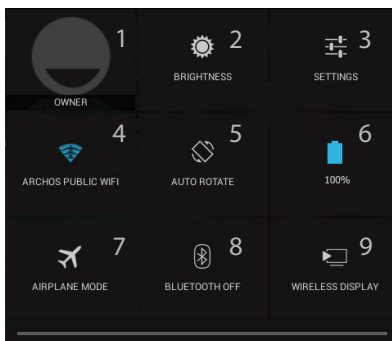

Быстрые настройки

- 1 Текущий пользователь⁽¹⁾
- 2 Регулировка яркости экрана.
- 3 Доступ ко всем настройкам.
- 4 Включение/выключение соединения Wi-Fi.
- 5 Активация/деактивация автоматической ориентации экрана при повороте устройства ARCHOS.
- 6 Процентная величина остатка заряда аккумулятора
- 7 Активация/деактивация всех беспроводных соединений, в частности, во время авиаперелета.
- 8 Включение/выключение соединения Bluetooth.
- 9 Включение беспроводной передачи данных⁽²⁾

⁽¹⁾Новая многопользовательская поддержка для планшетов предоставляет различным пользователям свое собственное отдельное, конфигурируемое место на одном устройстве. Добавьте пользователей в Settings > Device [Настройки > Устройство].

⁽²⁾Вы можете смотреть фильмы, видеоролики YouTube и все, что находится на вашем экране, на телевизоре высокой четкости. Чтобы быстро и легко отобразить то, что находится на вашем экране, нужно подключить адаптер беспроводной передачи данных к любому телевизору с мультимедийным интерфейсом высокой четкости (HDMI).

Последние приложения

Открывается список эскизов приложений, с которыми Вы недавно работали:

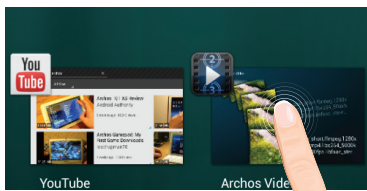

Коснитесь: , чтобы открыть приложение.

Удерживание: отображение параметров

RU

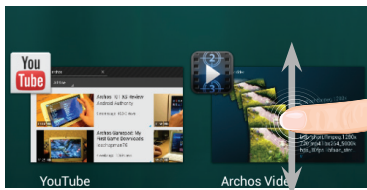

Прокрутка вверх или вниз: закрытие приложения.

Знакомство с Android™

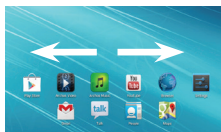

Расширенный домашний экран:

Выполняйте переходы между различными панелями домашнего экрана, смещая их влево и вправо.



Перемещение элемента домашнего экрана:

Прикоснитесь к элементу и удерживайте палец, пока не появится сетка позиционирования, затем переместите его в требуемое положение, и отпустите палец.



Удаление элемента домашнего экрана:

Прикоснитесь к элементу и удерживая палец, проведите его к верхней части экрана и отпустите над пиктограммой Remove (удалить).



Деинсталляция элемента:

Прикоснитесь к элементу на экране «Все приложения» и удерживая палец, проведите его к верхней части экрана и отпустите над пиктограммой Uninstall (деинсталлировать).



Создание папок приложений:

Поместите пиктограмму одного приложения поверх другого на домашнем экране, и две пиктограммы объединятся.



Виджеты:

Прикоснитесь к пиктограмме «Все приложения» на домашнем экране. Прикоснитесь к позиции Widgets в верхней части экрана. На основном экране Widgets можно переставлять виджеты таким же образом, как пиктограммы приложений.

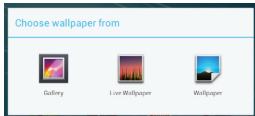

Изменение обоев:

Удерживайте палец на свободном месте домашнего экрана, затем выберите обои из списка.

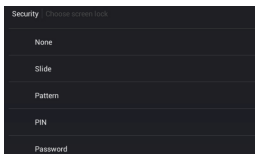

Блокировка сенсорного экрана:

Прикоснитесь к позиции Settings на панели быстрых настроек в строке состояния. На экране Settings выполните прокрутку вниз и прикоснитесь к позиции Security (защита). Прикоснитесь к позиции Screen lock (блокировка экрана). Выберите тип блокировки, который хотите использовать. После того, как будет установлена блокировка, при каждом пробуждении экрана будет отображаться экран блокировки с запросом на ввод комбинации символов, PIN-кода или иного указанного ключа.

RU



Использование клавиатуры

ARCHOS 101 XS 2 оснащен датчиком холла. Когда вы закроете планшет крышкой, экран автоматически отключится. Экран включится, когда вы поднимете крышку.

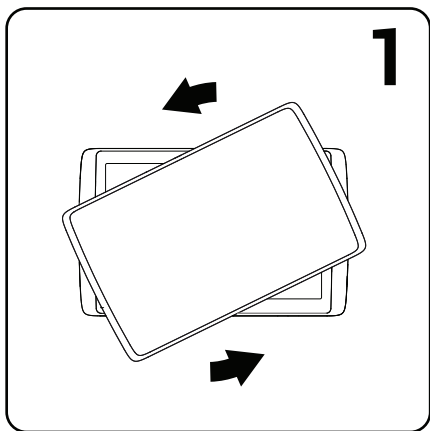

1. Поверните и поднимите планшет.

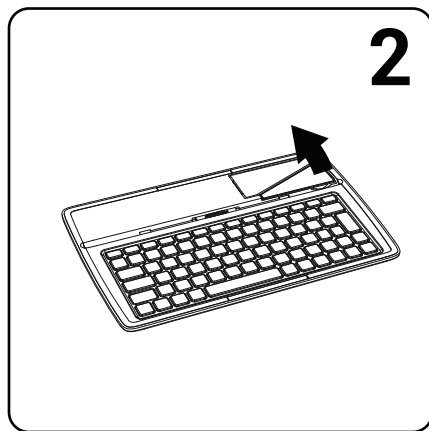

2. Поднимите и отогните подставку планшета.



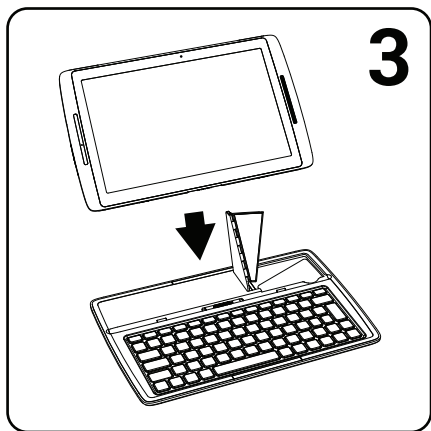

3. Поместите планшет в указанное положение.

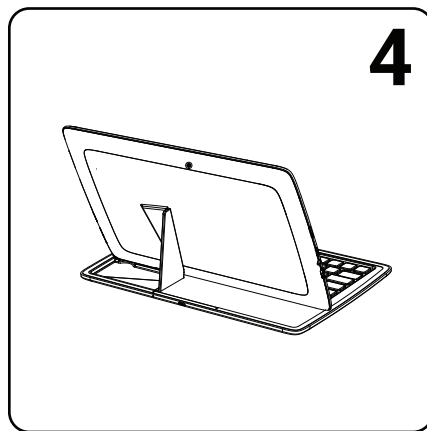

Вид планшета сзади.

RU



Устранение неполадок

В случае зависания планшета:

Нажмите на кнопку ВКЛ/ВЫКЛ и удерживайте в течение 10 секунд.

Если устройство не включается:

1. Зарядите устройство.

2. Нажмите на кнопку ВКЛ/ВЫКЛ и удерживайте в течение 10 секунд.

Если ваше устройство полностью разрядится

Зарядка устройства в течение по крайней мере 10 минут, прежде чем он включится.

Если Вы хотите продлить срок службы батареи:

Уменьшите яркость экрана и выключите беспроводные соединения, если они не используются.

Если устройство функционирует слишком медленно:

Закройте все приложения, которые в данный момент не используются.

Если принимаемый сигнал Wi-Fi слишком слаб:

Убедитесь, что не находитесь слишком далеко от узла доступа Wi-Fi.

Обновите встроенную микропрограмму устройства:

<http://www.archos.com/support>.

Сбросьте и повторно введите параметры соединения.

Обратитесь к провайдеру сети Wi-Fi.

Если хотите восстановить состояние изделия (забыли пароль? стереть все настройки?):

1. Удерживайте кнопку увеличения громкости + и Подключите прилагаемый кабель питания к устройству ARCHOS и к розетке.

2. Отображается зеленый робот Android. Отпустите кнопку громкости +.

3. удерживайте кнопку ВКЛ / ВЫКЛ и нажмите на кнопку громкости +.

Отображается восстановление системы Android.

4. Прокручивание осуществляется кнопками регулировки громкости, подтверждение — кнопкой включения и выключения.

- Выберите пункт "Wipe data/factory reset" [Стереть данные/заводские установки], подтвердите.

- Выберите "Yes -- delete all user data" [Да, удалить пользовательские данные] и подтвердите.

- Выберите "Reboot system now" [Перезагрузить систему] и подтвердите.

National restrictions

This device is intended for home and office use in all EU countries (and other countries following the EU directive 1999/5/EC) without any limitation except for the countries mentioned below:

Country	Restriction	Reason/remark
Bulgaria	None	General authorization required for outdoor use and public service
France	Outdoor use limited to 10 mW e.i.r.p. within the band 2454-2483.5 MHz	Military Radiolocation use. Refarming of the 2.4 GHz band has been ongoing in recent years to allow current relaxed regulation. Full implementation planned 2012
Italy	None	If used outside of own premises, general authorization is required.
Luxembourg	None	General authorization required for network and service supply (not for spectrum)
Norway	Implemented	This subsection does not apply for the geographical area within a radius of 20 km from the centre of Ny-Alesund
Russian Federation	None	Only for indoor applications

Note: Frequency 2454-2483.5MHz are restricted to indoor use in France.

Consult the declaration of conformity on http://www.archos.com/products/declaration_conformity.html



Open Source Software Offer

The software bundled with this product includes software files subject to certain open source license requirements. Such open source software files are subject solely to the terms of the relevant open source software license. Such open source software is provided on an “AS IS” basis to the maximum extent permitted by applicable law.

For the open source files contained herein, please access “Open source license” section located at: Settings>About tablet\Legal information on the device for the relevant copyright and licensing terms. You may obtain a copy of Apache License, Version 2.0 at <http://www.apache.org/licenses/LICENSE-2.0>. You may also obtain a copy of GNU General Public License, Version 2 at the Free Software Foundation, INC, 51 Franklin Street, Fifth Floor, Boston, MA 02110-1301, USA.

Until the date that is three years after our last shipment of this product, you may obtain a copy of the source code corresponding to the binaries for any GPL-Licensed file by contacting ARCHOS customer service at <http://www.archos.com> and ARCHOS will send you a link to such source code or will provide instructions to get the source on a physical medium.

This offer is valid to anyone in receipt of this information.

