

OLYMPUS

微型数码录音机
LS-11

微型数码录音机

详细使用说明书

CN

感谢您购买 Olympus 数码录音机。请阅读本手册以正确及安全地使用本产品。请将手册保存在方便取阅之处，以便作为日后之参考。
为确保能成功的录音，我们建议您在使用前先测试录音功能及音量。

简介

- 将来本文件的内容如有变更恕不预先通知。有关产品名称和机型号的最新信息请联系我们的顾客支持中心。
- 我们将尽最大努力确保文件内容的完整性。万一您发现可疑项目、错误或遗漏，请联系我们的顾客支持中心。
- 任何由于非 OLYMPUS 或授权之第三方进行的维修及由于其他任何原因所发生的数据损失而造成的任何被动伤害或任何伤害等责任，OLYMPUS 概不负责。

商标和注册商标

- IBM 和 PC / AT 是 International Business Machines Corporation 的商标或注册商标。
- Microsoft、Windows 和 Windows Media 是 Microsoft Corporation 的注册商标。
- Macintosh 和 iTunes 是 Apple Inc. 的商标。
- SD 徽标是商标。
- SDHC 徽标是商标。
- MPEG Layer-3 音频编码技术获得 Fraunhofer IIS 和 Thomson 的授权。
- EUPHONY MOBILE™ 是 DiMAGIC Corporation 的商标。
- DVM™ 是 DiMAGIC Corporation 的商标。

此处提到的其他产品和品牌名称可能是其各自拥有人的商标或注册商标。



EUPHONY
MOBILE



索引

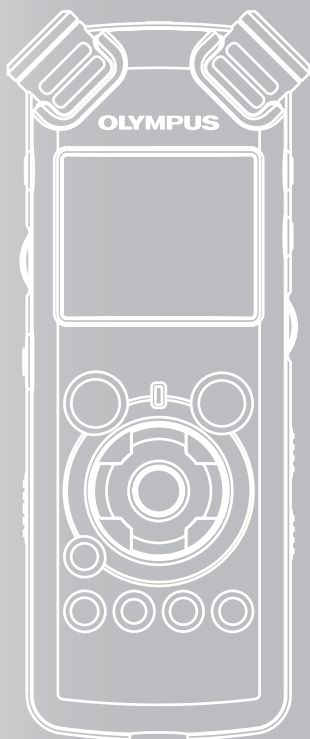

目录

P.4

安全和正确使用

P.6

开始启用

P.8

1

关于录音

P.22

2

关于播放

P.32

3

菜单设定

P.41

4

在您的计算机上使用录音机

P.61

5

其他信息

P.77

6

目录

简介

目录	4
安全和正确使用	6
一般注意事项	6
电池	7
交流转换器	7

开始启用

主要特色	8
部件名称	9
显示屏 (LCD 面板)	10
装上电池	11
使用交流转换器	12
电源	13
锁定 [HOLD]	13
设定时间/日期 [Time & Date]	15
更改时间/日期	16
插入和弹出卡	17
插入卡	17
弹出卡	18
关于文件夹	19
关于声音录音文件夹	19
关于音乐播放文件夹	20
选择文件夹与文件	21

关于录音

录音之前	22
将麦克风朝向原始音源	22
录音	23

听取录音中的声音	27
设定低频滤波器	27
麦克风电灵敏度	27
调节录音的语音同步水平	28
通过外部麦克风或其他设备录音	30

关于播放

播放	32
用耳机听时	35
设定定位标记和临时标记	35
如何开始片段重复播放	36
删除	38
每次删除一个文件	38
删除文件夹中所有文件	38
部分删除一个文件	39

菜单设定

菜单设定方法	41
录音机格式化 [Format]	51
重新编排文件 [Replace]	54
文件移动 [File Move]	56
文件分割 [File Divide]	59

在您的计算机上使用录音机

操作环境	61
连接至您的个人电脑	62
连接至您的个人电脑	62
结束与个人电脑的连接	63
传输声音文件到个人电脑	64
使用 Windows Media Player	65
窗口名	65

复制 CD 上的音乐	66
传送音乐文件至录音机	67
复制声音文件到 CD	70
使用 iTunes	72
窗口名称	72
复制 CD 上的音乐	73
传送音乐文件至录音机	74
复制声音文件至 CD	75
作为个人电脑的外部存储器使用	76

其他信息

警告信息列表	77
故障排除	78
规格	80

安全和正确使用

在使用新录音机之前，请仔细阅读此手册，确保掌握安全和正确操作的方法。请将此手册保管在方便取阅之处，以备日后参考。

- 警告符号表示重要的相关安全信息。为了保护自己和他人免受人身伤害或财产受损，阅读所提供的警告和信息至关重要。

一般注意事项

- 请勿将录音机放在炎热潮湿之处，例如夏季处于直射阳光下或海滩上的密封汽车内。
- 请勿将录音机保管在暴露于过于潮湿或灰尘过多之处。
- 请勿使用酒精或香蕉水等有机溶剂清洁组件。
- 请勿将录音机放在电视或冰箱等电器的上面或旁边。
- 避免在移动电话或其他无线设备的附近录音或播放，否则将造成干扰和噪音。如果有噪音，请移动到其他位置或将录音机从此类设备旁边移开。
- 避免沙子或灰尘。否则将造成无法弥补的损害。
- 避免强烈振动或冲击。
- 请勿自行拆卸、修理或改装组件。
- 请勿在驾驶车辆（例如自行车、摩托车或马车）时操作组件。
- 请将组件保管在儿童拿不到的地方。
- 将录音机安装在三脚架上时，旋转三脚架上的螺丝，而不是旋转录音机本身。

< 关于数据丢失的警告 >

由于操作错误、组件故障或在维修过程中，内存中录制的内容可能会被损坏或删除。

建议您将重要内容备份并保存在其他媒体上，例如计算机的硬盘。

奥林巴斯不承担任何被动损坏或由于产品缺陷、非奥林巴斯或奥林巴斯授权服务站的第三方维修及其他任何原因导致的数据丢失所引起的任何类型的损坏的责任。

电池

警告

- 电池不应暴露给火焰、加热、短路或分解。
- 请勿试图对碱性电池、锂离子或其他任何不能充电的电池进行充电。
- 请勿使用任何外表破裂的电池。
- 请将电池保管在儿童拿不到的地方。
- 如果在使用本产品时注意到任何异常，例如异常噪音、发热、冒烟或燃烧的气味，
 - ① 立即将电池卸下，小心不要烧伤自己，并且
 - ② 致电经销商或本地的奥林巴斯要求维修。

交流转接器

警告

- 请勿试图以任何方式拆卸、修理或改装交流转接器。
- 请勿使水、金属或易燃物质等异物进入产品。
- 请勿弄湿交流转接器或用湿手触摸。
- 请勿在可燃气体（包括汽油、挥发油和香蕉水）附近使用交流转接器。

万一

- ... 交流转接器的内部部件由于坠落或其他损坏而暴露在外，
- ... 交流转接器落入水中，或者有水、金属、易燃物质或其他异物进入转接器，
- ... 在使用交流转接器时注意到任何异常，例如异常噪音、发热、冒烟或燃烧的气味，
 - ① 请勿触摸任何暴露的部件；
 - ② 立即从电源插座断开电源插头，并且
 - ③ 致电经销商或本地的奥林巴斯要求维修。在这些条件下继续使用交流转接器将导致触电、火灾或受伤。

主要特色

- 采用能够忠实捕捉原音的高灵敏度、低噪音立体声麦克风。
内置立体声麦克风的外壳采用了加工的金属件，在设计中考虑到了特殊功能，并且同时实现了结构的抗振性。而且，通过将麦克风本身向外旋转 90°，可以得到自然环绕的立体声音效效果。
- 配备有高音质的放大电路。
采用低噪音放大电路，可得到高品质低噪音的录音效果。
- 支持线性 PCM 格式，其记录的音质堪比或超过 CD 水平。
能够逼真地记录各种不同的音源。可以在高采样频率实施高分辨率记录，其效果等同或胜过音乐 CD（采样频率 44.1 kHz，16 位）（☞ 第 41、43 页）。
- 支持种类丰富的记录格式。可以处理 MP3 格式（MPEG-1/MPEG-2 音频第 3 层）和 Windows Media Audio (WMA) 格式。
本装置支持 MP3 和 WMA 格式，可以高度压缩的方式保存文件，因此，可以大幅延长录音时间（☞ 第 41、43 页）。此外，在与外部装置相连时，录音机可以在没有个人计算机的情况下，对输入的音频仿真讯号进行编码（☞ 第 30 页）。
- 支持大容量记录媒体。除了 8 GB 内置闪存，您也可以采用市面有售的 SD 卡记录（☞ 第 17 页）。对于经确认可以用于本录音机的 SD 卡，请咨询奥林巴斯网站。
- 配备了各种支持音频录音的功能。
可以使用此录音机自定义各种录音功能（例如录音电平和麦克风灵敏度）以适应录音条件和个人偏好（☞ 第 41、44 页）。
- 允许通过增强选项和设备进行系统升级。进一步增强了录音的乐趣。
- 可以播放从计算机发送的 WAV、WMA 和 MP3 格式文件，以及装置自己录制的文件。可随时作为音乐播放器使用。
可容纳约 2000 个音乐文件（WMA 128 kbps/ 每首歌 4 分钟）（☞ 第 32、33、65、72 页）。
- 支持 USB 2.0。高速，可作为计算机的外存储器设备进行高速数据传输。
通过 USB 连接计算机后，可以保存图片及文本数据等，并可以携带数据（☞ 第 64、76 页）。
- 可以在内置内存与 SD 卡之间及内存的文件夹中移动或复制文件（☞ 第 56 页）。
- 可以分割在本录音机中以 PCM 格式记录的文件（☞ 第 59 页）或删除文件的一部分（☞ 第 39 页）。

部件名称

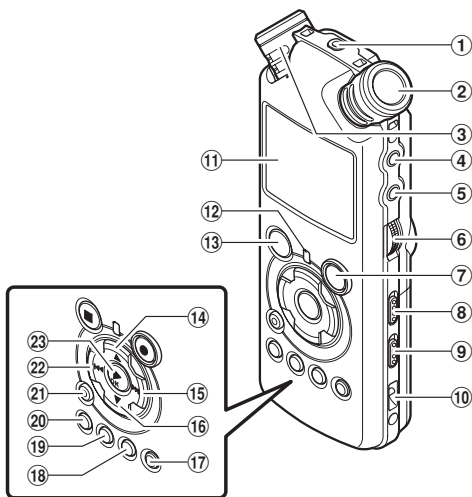

① REMOTE 插孔

连接专用遥控器组件 RS30W (可选) 的接收器。可以通过遥控器操纵录音机的记录和停止功能。

② 内置立体声麦克风 (R)

③ 内置立体声麦克风 (L)

④ LINE IN 插孔

⑤ MIC (麦克风) 插孔

⑥ REC LEVEL 转盘

⑦ REC ● (录音) 按钮

录音指示灯 (LED)

⑧ MIC SENSE HIGH/LOW 开关

⑨ LOW CUT ON/OFF 开关

⑩ 腕带孔

⑪ 显示屏 (LCD 面板)

⑫ PEAK 指示灯 (LED)

⑬ STOP ■ (停止) 按钮

⑭ ▲ 按钮

⑮ ►►I 按钮

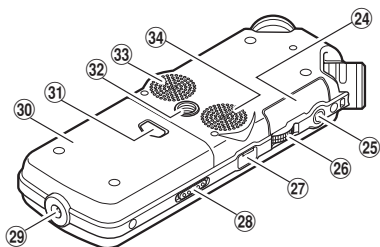

⑯ ▼ 按钮

⑰ LIST 按钮

⑱ MENU (菜单) 按钮

⑲ A-B REPEAT 按钮

⑳ Fn 按钮

㉑ ERASE (删除) 按钮

㉒ I◀◀ 按钮

㉓ ▶/OK 按钮

㉔ 卡盖

㉕ EAR (耳机) 插孔

㉖ VOLUME (音量) 转盘

㉗ USB 连接器

㉘ POWER/HOLD 开关

㉙ 电源插孔

㉚ 电池盒盖

㉛ 电池盖释放按钮

㉜ 三脚架插座

㉝ 内置立体声扬声器 (R)

㉞ 内置立体声扬声器 (L)

显示屏 (LCD 面板)

文件夹清单显示

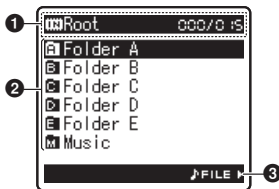

1 根文件夹指示

文件夹指示

记录媒体指示或文件夹指示/根文件夹名称/
现行文件号/在文件夹中已记录的文件总数

2 文件夹名称

3 导标指示

文件清单显示

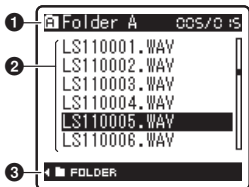

1 文件夹/文件指示

文件夹名称/现行文件号/在文件夹中已记录的
文件总数

2 文件名称

3 导标指示

文件显示

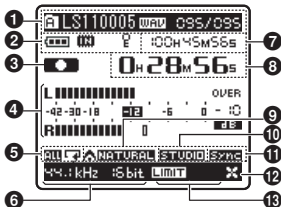

1 文件夹/文件指示

文件夹名称/文件名称/文件格式/现行文件
号/在文件夹中已记录的文件总数

2 电池指示

记录媒体指示

[] 内置闪存

[] SD 卡

删除锁定指示

3 录音/播放状态指示

4 录音电平表

5 播放模式指示

6 记录模式指示

7 在录音状态期间:

剩余记录时间

在播放或停止状态期间:

文件长度

8 在录音状态期间:

录音经过时间

在播放状态期间:

播放经过时间

9 [EUPHONY] 指示

10 [Reverb] 指示

11 [V-Sync. Rec] 指示

12 [LowCutFilter] 指示

13 [Limiter] 指示

[Zoom Mic] 指示

装上电池

- 1 按下电池盖释放按钮，然后在轻轻按压电池盖的同时滑动开启电池盖。

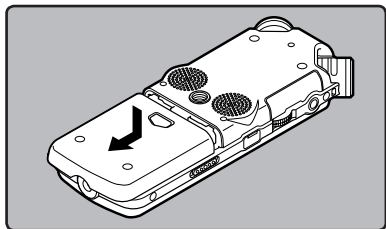

- 2 放进两节 AA 型电池，并注意 ⊕ 和 ⊖ 极性是否正确。

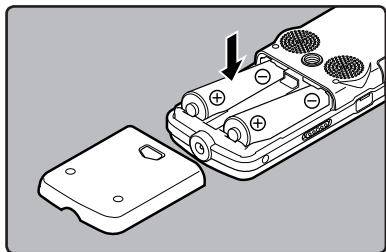

- 3 先向 (A) 方向按，再向 (B) 方向滑动，以关好电池盖。

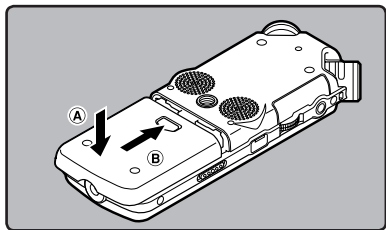

- 4 依箭头方向移动 **POWER/HOLD** 开关，并打开电源。

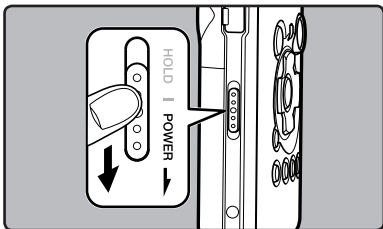

- 如果“小时”指示在显示屏中闪烁，请参阅“设定时间/日期 [Time & Date]” (E3* 第 15 页)。

更换电池

当电池没电时，显示屏的电池指示会改变。



- 当 [] 出现在显示屏时，尽可能立即更换电池。当电池电力太弱时，在显示屏上显示 [] 和 [Battery Low] 且录音机会关机。

Ni-MH 充电电池

奥林巴斯的 Ni-MH 充电电池 B-01 4PE (可选) 可用于录音机。请与 Olympus Ni-MH 充电器 B-90SU (可选) (用于美国与加拿大) 或 BU-90SE (可选) (用于欧洲) 配合使用。

备注

- 本录音机不能给电池充电。
- 锰电池不能用于本录音机。
- 更换电池时，建议使用 AA 碱性电池或 Olympus Ni-MH 充电电池。
- 在更换电池之前应确保关闭录音机电源（☞ 第 13 页）。当录音机正在使用时拆卸电池可能会造成文件损毁等故障。如您正在录入某一文件中而中途电池耗尽，则由于文件标题未能关闭而使您丢失当前记录好的文件。因此，一旦您在电池图标中见到仅剩一段标记时请尽快更换电池。
- 若更换电池时间超过 15 分钟，或者频繁取出并放入电池，在更换新电池后必须重设时间（☞ 第 15 页）。
- 若您长时间不使用录音机，请将电池取出。
- 播放声音/音乐文件时，若电池的电压输出调低，录音机可能会重设，视音量而定，即使 [] 显示在电池指示上也一样。若发生这种情况，请调低录音机音量。

使用交流转接器

将交流转接器（可选）插入家用电源插座并将录音机的电源插头连接到录音机的电源接口（直流 5V）。连接之前，始终关闭录音机电源。如果在使用电池进行录音的时候插入交流转接器，可能无法播放正在录制的声音数据。

- 有关可用于此录音机的交流转接器，请查询奥林巴斯网站。

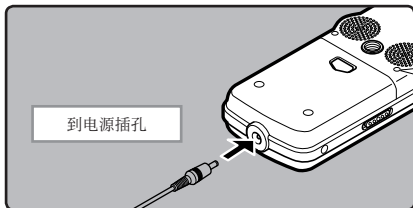

⚠ 警告

- 在连接或断开之前，始终关闭录音机电源。
- 不使用交流转接器时，从电源插座断开电源插头。
- 仅使用转接器上指定的正确电源电压。
- 将录音机连接到 USB 端口时，请勿使用交流转接器。

电源

当不使用录音机时，请关闭电源以便将电池消耗降到最低。即使电源关闭，现有的数据、模式设定和时钟设定都将保存。

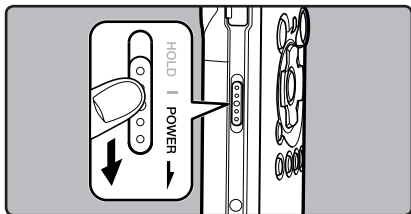

打开电源：

当录音机电源关闭时，请依箭头方向移动 **POWER/HOLD** 开关。

- 显示屏打开且电源打开。
- 恢复功能可将录音机带到电源关闭之前的内存中的停止位置。
- 从录音机中取出电池后，恢复功能的停止位置将被删除。

关闭电源：

依箭头方向移动 **POWER/HOLD** 开关并保持 1 秒或更长的时间。

- 显示屏关闭且电源关闭。
- 恢复功能可记忆电源关闭之前的停止位置。

省电模式 [AutoPowerOff]

如果录音机在电源开启时停止/不使用 10 分钟以上（预设），电源将关闭（☞ 第 41、47 页）。

- 如果在电池关闭之前按下任意按钮，则经过时间将重新开始计时，本功能暂不生效。

锁定 [HOLD]

如果将录音机设为 HOLD 模式，执行状态将保留，且全部按钮将停用。这项功能在将录音机放在袋子或口袋中携带时非常有用。

将录音机设定到 HOLD 模式

将 **POWER/HOLD** 开关滑动到 [HOLD] 位置。

- 在显示屏中出现 [Hold] 后，录音机即被设定到 HOLD 模式。

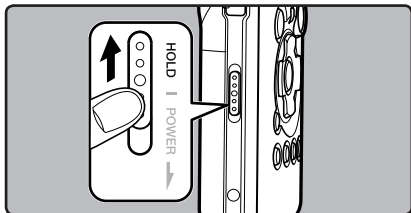

退出 HOLD 模式

将 **POWER/HOLD** 开关滑动到 **A** 位置。

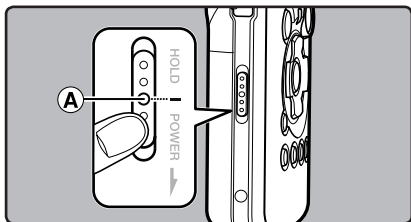

1

开始启用

备注

- 如果您在 HOLD 模式中按任何按钮，时钟显示会闪烁 2 秒，但不能操作录音机。
- 播放（或录音时）设定为 HOLD 后，将保持播放（录音）的状态不能进行任何操作（当播放结束，或因录满而结束录音后，进入停止状态）。
- 即使录音机处于锁定（HOLD）模式，也可以使用开关、转盘以及连接的专用遥控器组件 RS30W（可选）进行有效操作。

设定时间/日期 [Time & Date]

若您已预先设定时间和日期，本机将为各文件保存录音文件时的信息。预先设定时间和日期可使文件管理更方便。

购买录音机后第一次使用时，或将电池放入长期未用的装置时，[Set Time & Date] 会出现。“小时”闪烁时，请从步骤 1 开始操作。

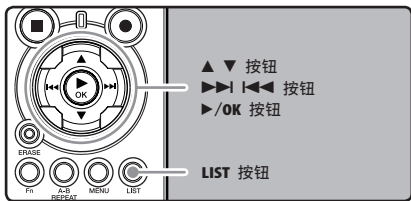

1 按 **▶▶▶** 或 **◀◀◀** 按钮以选择要设定的项目。

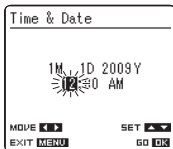

用闪光标记选择“小时”、“分钟”、“年”、“月”和“日”项目

2 按 **▲** 或 **▼** 按钮以进行设定。

按 **▶▶▶** 或 **◀◀◀** 按钮以同样的步骤选择下一个项目，然后按 **▲** 或 **▼** 按钮进行设定。

当您设定小时和分钟时，您可按动 **LIST** 按钮在 12 与 24 小时之间进行选择。

例：10:38 P.M (下午)

10:38 PM ←→ 22:38
(Initial setting)

设定时，您可通过按下 **LIST** 按钮选择“年”、“月”、“日”的顺序。

例：2009 年 1 月 1 日

1M 1D 2009Y (Initial setting)

↓
1D 1M 2009Y

↓
2009Y 1M 1D

3 按 **▶/OK** 按钮以完成设定。

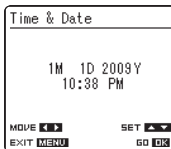

时钟将从设定的日期和时间开始计时。确认时间正确后按 **▶/OK** 按钮。

备注

- 若您在设定过程中按 **▶/OK** 按钮，录音机会保存当时的已设定项目。

更改时间／日期

在录音机处于停止模式时按下并按住 **STOP** 按钮以显示时间／日期、剩余内存和文件格式。

如果现行时间和日期不正确，请使用下列步骤进行设定。

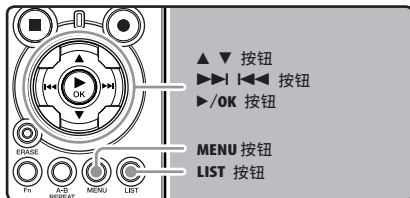

1 在录音机处于停止模式时按下 **MENU** 按钮。

- 菜单将出现在显示屏上 (☞ 第 41 页)。

2 按 **▲** 或 **▼** 按钮，选择 **[Others]** 标签。

- 移动设定标签光标，可以变更菜单显示。

设定时间／日期 [Time & Date]

3 按 **▶/OK** 或 **▶▶** 按钮，将光标移动到要设定的项目。

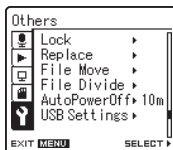

[Others] 将出现在显示屏上

4 按 **▲** 或 **▼** 按钮以选择 **[Time & Date]**。

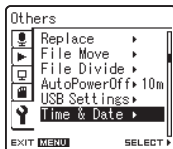

[Time & Date] 将出现在显示屏上

5 按 **▶/OK** 或 **▶▶** 按钮。

- “小时”指示会在显示屏上闪烁，指示时间／日期设定过程开始。

接下来的步骤与“设定时间／日期 [Time & Date]”中的步骤 1 到步骤 3 相同 (☞ 第 15 页)。

6 按 **MENU** 按钮以关闭菜单。

插入和弹出卡

本录音机可以使用市面上的 SD 卡以及内置闪存。

插入卡

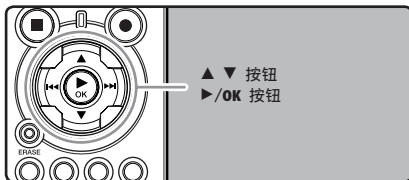

1 录音机处于停止模式时，打开卡盖。

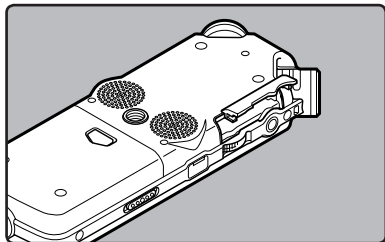

2 卡朝向正确后，将其插入卡槽，如图所示。

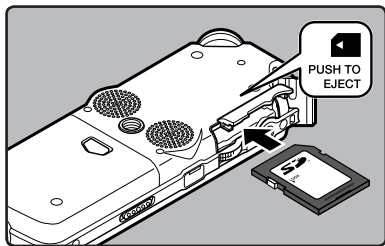

- 笔直地插入卡。
- 在完全插入后，卡停止，并发出“咔哒”声。
- 卡插入方向错误或者倾斜插入，可能损坏接触区域或导致其被卡住。
- 如果卡未完全插入，可能导致数据无法写入。

3 牢固关闭卡盖。

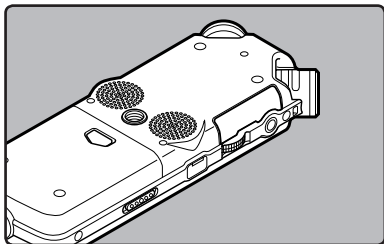

4 在记录到卡时，按下 ▲ 或 ▼ 按钮并选择 [Yes]。

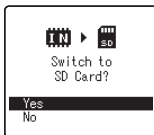

在您插入卡时，将出现记录媒体切换画面。

5 按 ►/OK 按钮以完成设定。

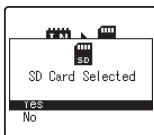

1

开始启用

备注

- 可以将记录媒体切换为内置闪存 (☞ 第 41、46 页)。
- 在某些情况下, 无法识别经其它装置 (例如计算机) 格式化 (初始化) 的卡。使用前, 请务必使用本录音机对其进行格式化 (☞ 第 51 页)。
- 在 SD 卡被写保护的情况下尝试执行诸如重写 SD 卡的内容等操作时, 将显示 [SD Card Locked]。可以进行播放操作, 但在覆盖卡上的内容时, 必须先关闭写保护。
- 不能使用不符合 SD 标准的卡, 诸如多媒体卡。

弹出卡

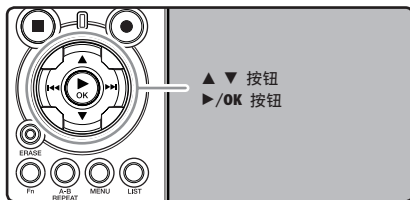

1 录音机处于停止模式时, 打开卡盖。

2 向内推卡, 使之解锁, 并令其部分弹出。

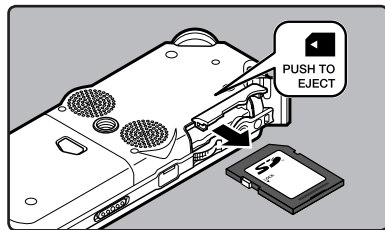

- 卡明显脱离插槽后, 可以安全地取出。

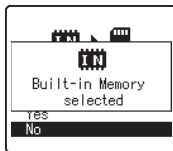

[MemorySelect] (内存选择) 设定为 [SD Card] (SD 卡) 时, 将出现 [Built-in Memory selected] (已选择内置内存)

3 牢固关闭卡盖。

备注

- 在向内推卡后, 快速释放您的手指可能导致其用力从插槽中弹出。

关于 SD 卡

SD 卡写保护时, 将出现 [SD Card Locked] 的显示。插入卡之前, 关闭写保护功能。对于经确认可以用于本录音机的 SD 卡, 请查询奥林巴斯网站。

如果写保护开关位于 [LOCK] 方向, 则无法进行录音及其他功能

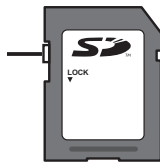

备注

- 录音机可能无法正确识别某些 SD 卡。此时, 取出卡再重新插入, 查看是否能够识别。
- 反复写入和删除会使 SD 卡的处理性能降低。此时, 将 SD 卡格式化 (☞ 第 51 页)。

关于文件夹

内置闪存或 SD 卡可以用作记录媒体。无论记录媒体种类如何，声音文件与音乐文件会分别放入声音录音文件夹及音乐播放文件夹，依树状结构整理并储存。

关于声音录音文件夹

[Folder A] - [Folder E] 是声音录音文件夹。用录音机录音时，请选择 5 个文件夹之一，然后录音。

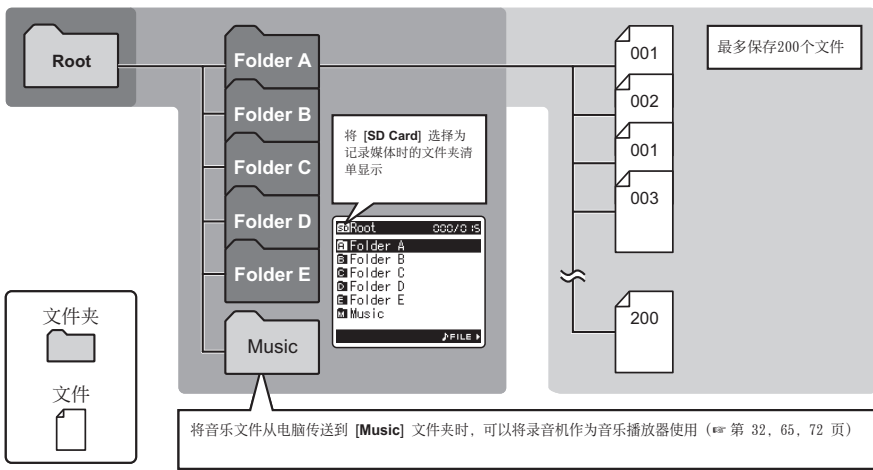

1

开始启用

对于本录音机记录的文件，文件名称将自动创建。

LS11 0001 .WAV

①

②

③

① 用户标识符:

本用户标识符名已设定在数码录音机中。

② 文件号:

连续指定的序列号，与记录媒体无关。

③ 扩展名:

用本装置录音时，以下是记录格式的文件名扩展名。

- 线性 PCM 格式 .WAV
- MP3 格式 .MP3
- WMA 格式 .WMA

关于音乐播放文件夹

使用 Windows Media Player 将音乐文件传输至录音机时，音乐播放文件夹内会自动建立一个文件夹，内含层次结构，如下图所示。同一个文件夹中的音乐文件可依偏好顺序重新整理并重播（☞ 第 54 页）。

1

开始启用

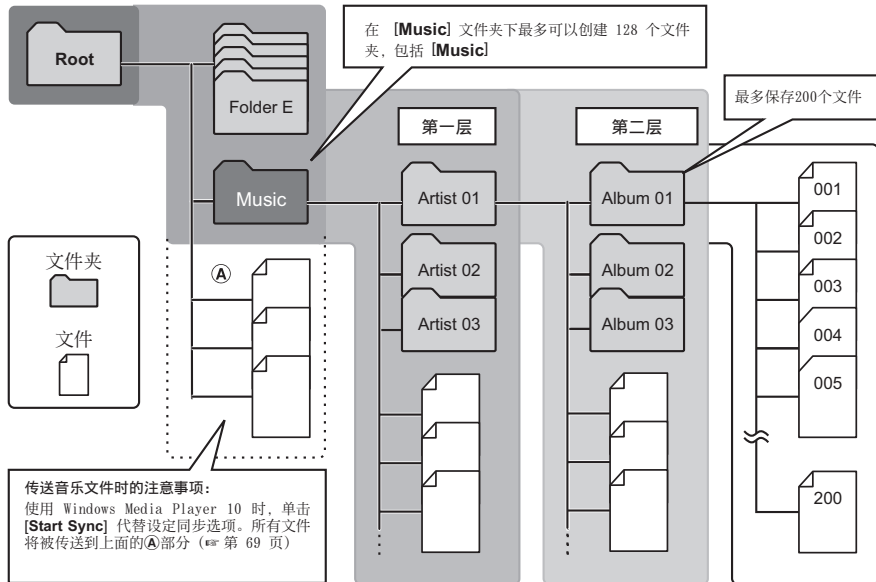

选择文件夹与文件

停止操作时变更文件夹。有关文件夹层次结构的信息，请参阅“关于文件夹”（ 第 19、20 页）。

音乐播放文件夹的操作

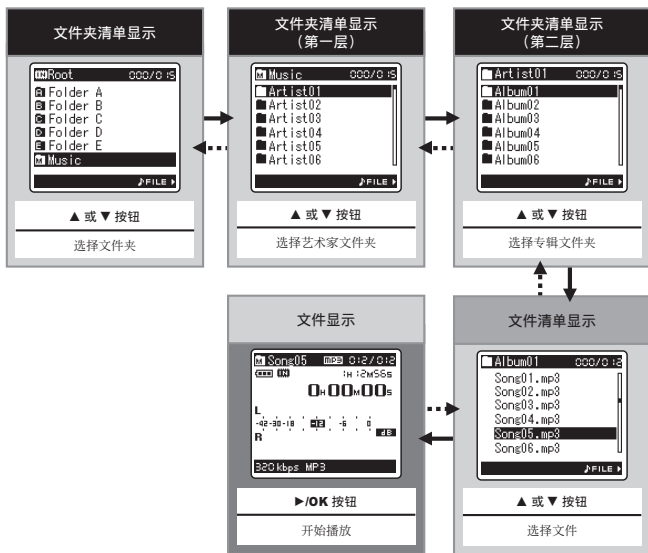

■ 在层次之间移动

▶/OK 按钮

前进 

每按一下打开在清单显示中所选的文件夹或文件并前进到下一层。可以用  按钮操作清单显示画面。

LIST 按钮

后退 

每按一下回到上一层。可以用  按钮操作清单显示画面。

清单显示

显示在本录音机上记录的文件夹和文件。

文件显示

显示所选文件的信息。进入播放待机模式。

声音录音文件夹的操作

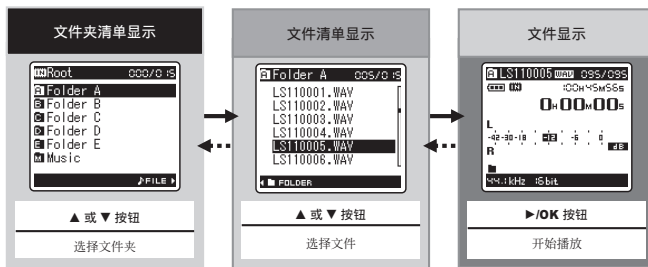

关于录音

录音之前

2

关于录音

准备

安装风挡：

在麦克风上安装风挡（内附）之后再开始录音。即便安装了风挡，在有强风对着麦克风吹的时候，还是可能会出现噪音。

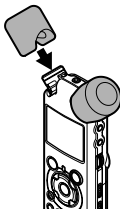
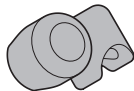

选择记录的媒体：

可以使用内置闪存和 SD 卡（见第 17、41、46 页）。

选择记录格式：

可以通过线性 PCM 格式、WAV、MP3 和 WMA 格式进行录音（见第 41、43 页）。

将麦克风朝向原始音源

将内置立体声麦克风朝向要记录的声音。将内置立体声麦克风放在显示屏上是进行立体声录音的正确位置。如果录音时麦克风位于显示屏之下，则无法进行正确的立体声录音，因为原始声音的位置将以反相记录。



用内置麦克风录音时：

将麦克风朝向要记录的声音。

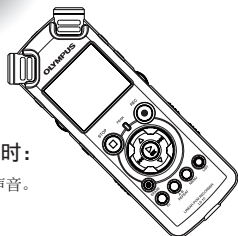

关于内置立体声麦克风：

麦克风捕获声音的方向可通过 **MIC SENSE HIGH/LOW** 开关变更（见第 27 页）。

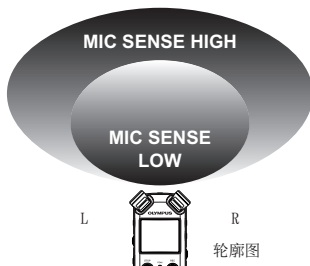

安装时：

将录音机配合市售的照相机三脚架使用时，可精确调节麦克风的角度等。

录音

开始记录前，在 [A] 至 [E] 之间选择一个文件夹。这五个文件夹可以用来区分不同类别的记录；例如，文件夹 [A] 可以用来储存私人数据，文件夹 [E] 可专门用来保存商务数据。

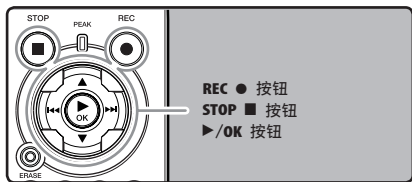

1 选择录音的文件夹 (☞ 第 19 到 21 页)。

如何变更文件夹：

- 1 停止时，在文件显示上按 **LIST** 按钮可回到上一层。
重复按 **LIST** 按钮可回到文件夹清单显示。
- 2 在文件夹清单显示中按 **▲** 或 **▼**，可选择声音录音文件夹。
 - 最新记录的音频将被保存为选定文件夹中的最后一个文件。

2 按 **REC ●** 按钮以开始录音。

- 将麦克风朝向要记录的声音。
 - a 剩余记录时间
 - b 电平表 (配合录音电平和记录功能设定而变化)
 - c 录音模式

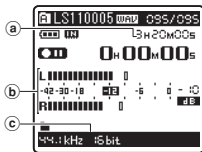

- 录音指示灯闪烁，[**CD**] 出现在显示屏上。
- 语音同步录音开启时，可以设定语音同步水平。
- [**Rec Mode**] 在录音待机模式中或录音中无法变更。等录音机停止时再设定 (☞ 第 41、43 页)。
- 可设定各种录音相关功能以适应录音条件 (☞ 第 41、43、44 页)。
- 电平表的电平指示位置将随各种录音相关设定的切换而变更。切换设定后通过电平表来确认录音电平。

3 使用 **REC LEVEL** 转盘调节录音电平。

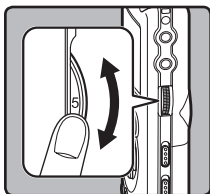

可在 [0] 到 [10] 的范围之间进行调节。转盘上的数字越大，录音电平越高，电平表的指示位置也将增长

- 即使在音源的音量剧烈变化等录音条件下，本录音机也应能够清晰均匀地进行录音。但是，通过手动调节录音电平，可以得到更高的录音音质。
- 如果输入过大的音量，即使 [**Rec Level**] 设为 [**Auto**] 或 [**Limiter On**]，也可能产生噪音。另外在某些情况下，指示输入过大的 [**PEAK**] 指示灯可能不会点亮。为确保成功录音，建议您在使用前先测试录音功能和音量。
- [**Rec Level**] 设为 [**Auto**] 时，将自动调节录音电平。使用录音电平调节功能和限幅器功能将 [**Rec Level**] 设为 [**Manual**] (☞ 第 41、43 页)。

实际生成要记录的声音：

- 生成很大的声音时，电平表将在录音过程中一直向右侧摇摆，并且 [PEAK] 指示灯将亮起。此时，由于录音电平过高，记录的声音将发生扭曲。

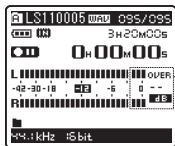

电平表超出最大值时（记录的声音将发生扭曲）

- 生成很大的声音时，调节录音电平，使电平表维持在 [-6] 附近。

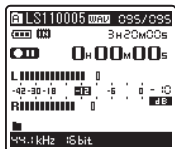

降低录音电平并调节过量输入的示例

4 再次按下 REC 按钮开始录音。

- [] 将出现在显示屏上。

① 录音经过时间

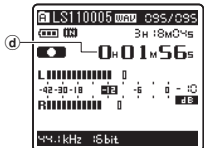

5 按 STOP 按钮以停止录音。

- [] 将出现在显示屏上。

② 文件长度

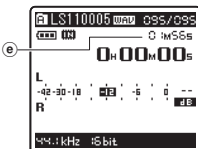

备注

- 在线性 PCM 格式录音中，即使单个文件的大小超过 2 GB，录音也将继续（参 第 43 页）。
 - 文件将保存为多个 2 GB 的文件。播放时将作为多个文件处理。
 - 录音超过 2 GB 时，文件夹中的文件数可能会超过 200。录音机将无法识别第 201 个之后的文件，因此通过将录音机连接到 PC 进行计数。
- 在 SD 卡插入录音机后，请务必确认记录媒体为 [Built-in Memory]（内置内存）或 [SD Card]（SD 卡），以免发生错误（参 第 41、46 页）。
- 在 SD 卡被写保护的情况下尝试执行诸如重写 SD 卡的内容等操作时，将显示 [SD Card Locked]。可以进行播放操作，但在覆盖卡上的内容时，必须先关闭写保护（参 第 18 页）。
- 如果您选择 [A] 至 [E] 以外的文件夹，按下 REC 按钮时，一条 [Can't record in this folder]（无法向此文件夹内记录）的讯息将闪烁。从 [A] 至 [E] 中选择一个文件夹再次开始录音。

- 当剩余录音时间少于 60 秒时, [PEAK] 指示灯开始以黄色闪烁。录音时间减少到 30 或 10 秒时, 指示灯会闪烁得更快。
- 文件夹容量变满时, 将出现 [Folder Full] (文件夹已满)。继续记录之前, 请删除任何不需要的文件 (☞ 第 38 页)。
- 内存变满时, 将出现 [Memory Full] (内存已满)。请更改可记录的媒体或删除不必要的文件, 然后再录音 (☞ 第 38、41、46 页)。
- 按一次专用遥控器组件 RS30W (可选) 的录音按钮时, 将立即开始录音。
- 根据录音模式和记录媒体的状态, 在录音期间可能无法及时向媒体进行数据传输, 并可能记录跳过的声音。在这种情况下, 录音期间或录音完成时, 将出现 [Data Write Error]。将数据传输到 PC 后, 格式化记录媒体。
- 我们建议在开始记录前, 对记录媒体进行格式化。

暂停

在录音机录音模式期间, 按 **REC ●** 按钮。

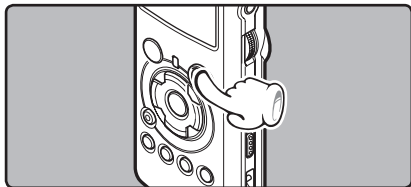

- [**⏸**] 将出现在显示屏上。
- 当暂停 60 分钟, 录音机将“录音暂停”停止。

恢复录音:

再次按 **REC ●** 按钮。

- 会自中断处继续录音。

快速检查录音的内容

在录音机录音模式期间, 按 **▶/OK** 按钮。

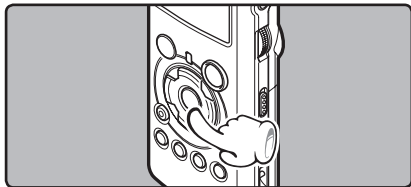

- [**▶**] 将出现在显示屏上。
- 停止录音, 播放刚录好的文件。

根据录音条件推荐的设定

录音机设定为可立即进行堪比音乐 CD 的高音质录音。与录音相关的各种功能皆可详细设定，以适应录音条件。

录音设定	录音条件					
	室内音乐表演	工作室内的乐队演奏	宽敞的大厅内的表演等	有鸟叫以及铁路声音等的室外环境	在宽敞的会议场所进行的大群体会议	少数人参加的室内会议
录音电平 * (<small>☞</small> 第 23 页)	[Rec Level] 设为 [Manual] 时，可以调节录音电平。 观察电平表的同时进行调节					
麦克风灵敏度 (<small>☞</small> 第 27 页)	[LOW]			[HIGH]		
低频滤波器 (<small>☞</small> 第 27 页)	[OFF]			[ON]		
[Rec Mode] (<small>☞</small> 第 41、43 页)	可调节录音电平以适应原始声音的音量					
[录音电平] (<small>☞</small> 第 41、43 页)	可以详细设定自动或手动调节录音电平。 [Rec Level] 设为 [Manual] 时，可以详细设定限幅器功能。					
[Zoom Mic] (<small>☞</small> 第 41、43 页)	可根据要录音的音源设定内置立体声麦克风的指向性					
[Rec Monitor] (<small>☞</small> 第 41、44 页)	选择是否从 EAR 插孔输出录音监听的声音					
[Plug-inPower] (<small>☞</small> 第 41、44 页)	根据连接到 MIC 插孔的外接麦克风选择是否使用插入式电源功能					

* [Rec Level] 设为 [Auto] 时，将自动调节录音电平。此时，录音电平调节功能和限幅器功能将不生效 (☞ 第 23、41、43 页)。

听取录音中的声音

将耳机插入本机的 **EAR** 插孔后再开始录音时，可以听到录音中的语音。录音监听音量可以使用 **VOLUME** 转盘来调节。

将耳机插入录音机的 **EAR** 插孔。

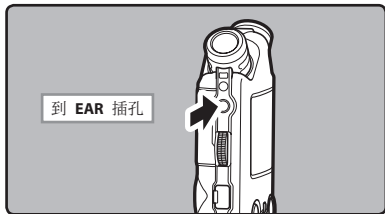

- 录音开始后可以用耳机监听录音中的语音。连接耳机后，扬声器将不会发出声音。

备注

- 录音电平不能通过音量按钮来控制。
- 使用耳机时，千万不要将音量设太高。太高的音量可能会导致听力损坏。
- 请不要将耳机放在麦克风附近，否则可能导致啸叫。
- 如果在录音时连接外部扬声器，则会产生音频反馈的风险。建议使用耳机进行录音监听，或者在录音时将 **[Rec Monitor]** 设为 **[Off]** (☞ 第 41、44 页)。
- 当 **[Rec Monitor]** 设为 **[Off]** 的情况下，录音时将不会从耳机发出声音 (☞ 第 41、44 页)。

设定低频滤波器

录音机具有低频滤波器功能，可以将低频声音降至最低，使录音更清晰。此功能能够降低空调、投影机及其他类似噪音。

滑动 **LOW CUT ON/OFF** 开关并选择 **[ON]** 或 **[OFF]**。

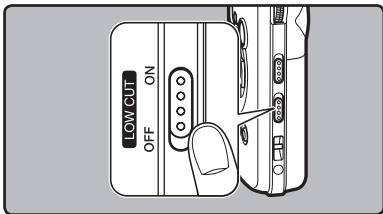

- [ON]:**
启用低频滤波器功能。
- [OFF]:**
禁用此功能。

麦克风灵敏度

麦克风灵敏度可视录音需要做调节。

滑动 **MIC SENSE HIGH/LOW** 开关，选择 **[HIGH]** 或 **[LOW]**。

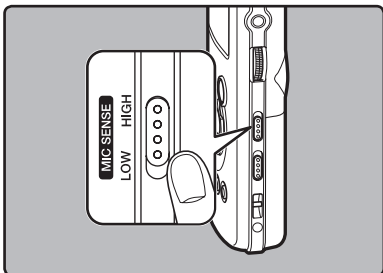

[HIGH]:

这个模式相当灵敏，可录到周围杂音。

[LOW]:

这个模式的麦克风灵敏度为标准等级。若来源音量大，例如乐团演奏，可选择这个模式。

备注

- 要清楚录音演讲者的声音时，请将录音机设为 **[LOW]**，让内置的立体声麦克风靠近演讲者的嘴（5-10 cm）再录音。

2

关于录音

调节录音的语音同步水平

使用语音同步录音，可以在检测到语音高于语音同步水平（检测水平）时开始录音，并在语音变小时自动停止录音。语音同步录音开启（ 第 44 页）且语音低于语音同步水平（检测水平）的时间超过指定的检测时间时，录音机停止。

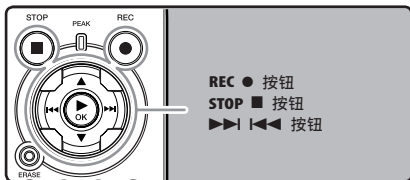

- 1 选择录音的文件夹（ 第 19 到 21 页）。

如何变更文件夹：

- ① 停止时，在文件显示上按 **LIST** 按钮可回到上一层。
重复按 **LIST** 按钮可回到文件夹清单显示。
- ② 在文件夹清单显示中按 **▲** 或 **▼**，可选择声音录音文件夹。
 - 最新记录的音频将被保存为选定文件夹中的最后一个文件。

2 按 REC ● 按钮以开始录音。



[Level Fixed?] 将在显示屏上闪烁。

- 要使用语音同步录音，将 [V-Sync. Rec] 设为开启，并设定检测时间（参 第 44 页）。

3 按 ►► 或 ◀◀ 按钮以调节语音同步水平。



在这个步骤中（[01] 至 [38]）在显示屏上显示语音同步水平。

- 值越高，录音机对声音就越敏感。在值最高时，最微弱的声音也能够启动录音。
- ① 语音同步水平（根据设定的水平向右/左移动）

4 再次按下 REC ● 按钮。

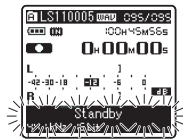

- 录音进入待机。[Standby] 在显示屏上闪烁，录音指示灯闪烁。如果输入达到或超过语音同步水平，录音自动开始。此时，录音指示灯点亮。

5 录音自动停止。

- 如果音量等于或低于语音同步水平的的时间超过指定时间，录音自动停止。此时，录音指示灯熄灭。
- 要手动停止录音，按 STOP ■ 按钮。

通过外部麦克风或其他设备录音

可连接外部麦克风和其他设备，并录音。按下列方法连接要使用的设备。

- 录音时，请勿将装置插入录音机插孔，或从录音机拔出装置。

2

关于录音

用外部麦克风录音：

将外部麦克风连接到录音机的 **MIC** 插孔。

- 在连接外部单声道麦克风的情况下录音时，则只有 L 声道可录音。

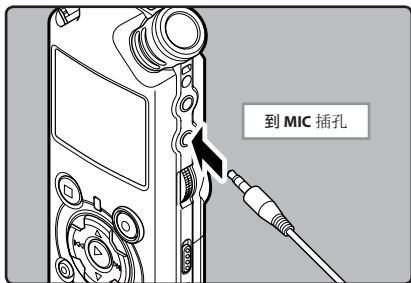

适用的外接麦克风（选购）

立体声麦克风：ME51S

内置灵敏大管径麦克风，提供立体声录音。

双声道麦克风（全方位）：ME30W

全方位麦克风相当灵敏，支持插入式电源，非常适合录音音乐表演。

单声道麦克风相当灵敏，可消除杂音（单向）：ME52W

这个麦克风适用于录音远处声音，同时调低周围杂音。

小巧的枪式麦克风（单向型）：ME31

定向麦克风对于在户外记录野生鸟类的啁啾等很有帮助。主体由金属雕刻而成，结构坚固，刚度高。

领带夹式麦克风（全方位）：ME15

带有领带夹的小型隐形麦克风。

电话拾音器：TP7

耳机型麦克风可在打电话时塞在耳朵里。可清晰地记录电话里的声音或对话。

备注

- 将外接麦克风插入录音机的 **MIC** 插孔时，内置麦克风将无法使用。
- 也可使用支持插入式电源的麦克风。插入式电源功能设为 **[On]** 时，将由录音机向麦克风供电（☞ 第 41、44 页）。
- 如果连接了不支持插入式电源功能的外接麦克风，请将插入式电源功能设为 **[Off]**，否则录音时可能会产生噪音（☞ 第 41、44 页）。
- 使用外部麦克风录音时，请勿将连接电缆连接到 **LINE IN** 插孔。

使用本录音机记录其他设备的声音：

当连接其他设备的音频输出（耳机插孔）时，而且录音机的 **LINE IN** 插孔插有连接复制用电缆 KA334（内附）时，可进行录音。



备注

- 如果即使调节了录音电平（☞ 第 23 页）也无法用本录音机进行清晰的录音，可能是由于所连接设备的输出电平过高或过低。当连接外部设备时，请进行录音测试，并调节外部设备的输出电平。
- 使用本录音机记录其他设备的录音时，请勿将连接电缆连接到 **MIC** 插孔。

用其他设备记录本录音机的声音：

当把本录音机的 **EAR** 插孔和其他设备的音频输入终端（麦克风插孔）用复制用电缆 KA334（内附）连接时，本录音机的声音可录制到其他设备。

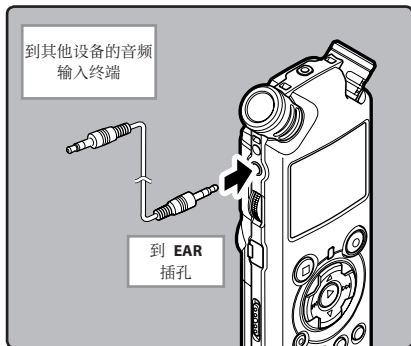

备注

- 在录音机上调节与播放相关的各种音质设定时，从 **EAR** 插孔发出的音频输出讯号也将随之变更（☞ 第 41、45 页）。
- 在其他设备上无线录音时，如果将音频输入到麦克风插孔，输入可能会过大而无法控制。此时，请使用带有衰减电阻的连接电缆 KA333（可选）。

关于播放

播放

本录音机可播放 WAV、MP3 和 WMA 格式的文件。要播放使用其他设备记录的文件，您需要从电脑进行传送（复制）。

3

关于播放

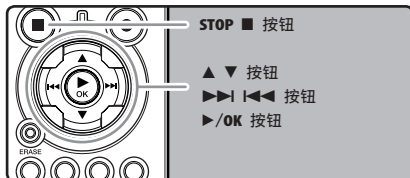

1 请选择包含要播放文件的文件夹（见第 19 到 21 页）。

如何变更文件夹：

- 1 停止时，在文件显示上按 **LIST** 按钮可回到上一层。
重复按 **LIST** 按钮可回到文件夹清单显示。
- 2 在文件夹清单显示中按 **▲** 或 **▼**，可选择声音录音文件夹，然后按 **▶▶▶** 按钮。

2 在文件清单显示中，按 **▲** 或 **▼** 按钮选择要播放的文件。

- 在文件显示中，按 **▶▶▶** 或 **◀◀◀** 按钮选择文件。

3 按 **▶/OK** 按钮以开始播放。

- [] 将出现在显示屏上。
 - a 文件夹名称/文件名称/文件格式/现行文件号/在文件夹中已记录的文件总数
 - b 文件长度
 - c 播放经过时间
 - d 录音电平表

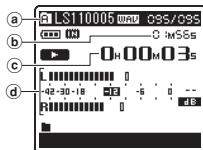

4 使用 **VOLUME** 转盘以调节至合适的音量。

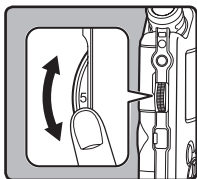

可在 [0] 到 [10] 的范围之间调节音量。转盘上的数字越大，音量越大。

5 在您需要停止播放的任意位置上按 **STOP** 或 **▶/OK** 按钮。

- [] 将出现在显示屏上。
- 这可从中间停止播放的文件。启用续播功能时，即使电源已关闭，仍能登记停止位置。下一次打开电源时，可从登记的停止位置继续播放。
- 从录音机中取出电池后，恢复功能的停止位置将被删除。

与播放相关的设定

片段重复播放 (☞ 第 36 页)	该功能可在播放过程中重复播放文件的一部分。
[播放模式] (☞ 第 41、45 页)	[File] [File Repeat] [Folder] [Folder Repeat] [All] [All Repeat]
[Reverb] (☞ 第 41、45 页)	[Normal] [Studio] [Club] [Hall] [Dome]
[EUPHONY] (☞ 第 41、45 页)	[Normal] [Natural] [Wide] [Power]
[Replace] (☞ 第 54 页)	这个功能可在选定文件夹中变更文件的顺序。在正确播放模式时, 依偏好顺序播放文件, 这个功能非常实用。
[File Move] (☞ 第 56 页)	可以在存储设备之内或之间移动或复制选定文件。
[File Divide] (☞ 第 59 页)	可以分割由本录音机记录的 PCM 文件。

关于音乐文件

若录音机无法播放已传输的音乐文件, 请查看取样频率及位率是否在可播放的范围内。下表是录音机可播放的有关音乐文件的取样频率及位率的组合。

文件格式	取样频率	位率
WAV 格式	44.1 kHz、48 kHz、 88.2 kHz、96 kHz	16 比特或 24 比特
MP3 格式	MPEG1 Layer3: 32 kHz、44.1 kHz、 48 kHz MPEG2 Layer3: 16 kHz、22.05 kHz、 24 kHz	8 kbps 以上, 最高至 320 kbps
WMA 格式	16 kHz、22 kHz、32 kHz、 44.1 kHz、48 kHz	16 kbps 以上, 最高至 256 kbps

- 可变位率 MP3 文件(转换位率可能不同)可能无法正确播放。
- 本录音机只能播放线性 PCM 格式的 WAV 文件。其他格式的 WAV 文件均无法播放。
- 本录音机兼容 Microsoft Corporation DRM9, 但不兼容 DRM10。
- 可以播放由奥林巴斯数码语音录音机创建的 WMA 文件。

快进

在文件显示中，录音机处于停止模式期间，按下并按住 **▶▶|** 按钮。

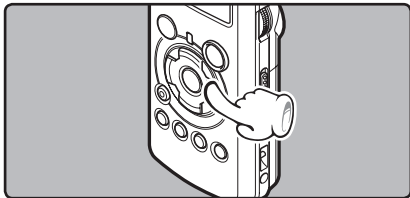

- [**▶▶|**] 将出现在显示屏上。
- 松开 **▶▶|** 按钮则停止。按 **▶/OK** 按钮从停止位置开始播放。

在录音机播放模式期间，按下并按住 **▶▶|** 按钮。

- 当释放 **▶▶|** 按钮时，该录音机将恢复到普通播放状态。
- 如果文件中间有定位标记或临时标记，录音机将在该位置停止 (☞ 第 35 页)。
- 当录音机到达该文件的末端时停止。继续按 **▶▶|** 按钮将会从下一个文件的开始端进行快进。

快倒

在文件显示中，录音机处于停止模式期间，按下并按住 **◀◀|** 按钮。

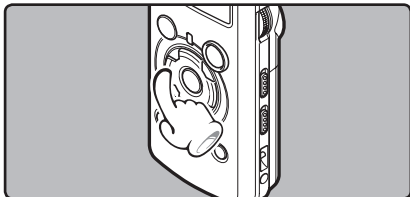

- [**◀◀|**] 将出现在显示屏上。
- 松开 **◀◀|** 按钮则停止。按 **▶/OK** 按钮从停止位置开始播放。

在录音机播放模式期间，按下并按住 **◀◀|** 按钮。

- 当释放 **◀◀|** 按钮时，该录音机将恢复到普通播放状态。
- 如果文件中间有定位标记或临时标记，录音机将在该位置停止 (☞ 第 35 页)。
- 当录音机到达该文件的开始端时停止。继续按 **◀◀|** 按钮将会从前一个文件的末端进行快倒。

定位在文件的始端

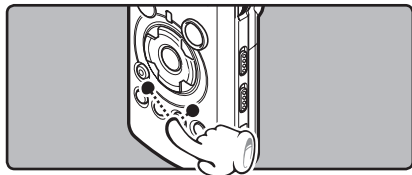

录音机处于停止模式或播放模式期间，按下 **◻** 按钮。

- 录音机跳到下一个文件的开头。
- 在录音机播放模式期间，按 **◀◀|** 按钮。
- 录音机跳到当前文件的开头。

在录音机停止模式期间，按 **◀◀|** 按钮。

- 录音机跳到上一个文件的开头。如果录音机停在文件的中途，则会返回文件的开头。

在录音机播放模式期间，按两次 **◀◀|** 按钮。

- 录音机跳到上一个文件的开头。

用耳机听时

可将耳机插入录音机的 **EAR** 插孔来听。

- 使用耳机时扬声器就不能再发出声音。



备注

- 在播放过程中跳到文件的开头时，录音机将在定位标记和临时标记处停止。如果在停止模式下执行操作，将跳过定位标记和临时标记（☞ 第 35 页）。
- 为避免听力受到刺激，请在音量调低后才插入耳机。
- 当用耳机收听时，不要将音量调得过大。否则会导致听力问题和听力下降。

设定定位标记和临时标记

如果设定有定位标记和临时标记，您可以在快进和快倒过程中以及在提示文件时快速找到要收听的位置。

定位标记和临时标记只能在本录音机进行 PCM 录音时添加，或者添加到使用本录音机记录的 PCM 文件中。您无法在 WMA 文件、MP3 文件以及除 Olympus 1C 录音机以外的其它设备上建立的文件内添加定位标记。但是可以添加临时标记，用于临时记忆所需位置。

要添加定位标记，必须将定位功能注册到 **Fn** 按钮（☞ 第 48 页）。

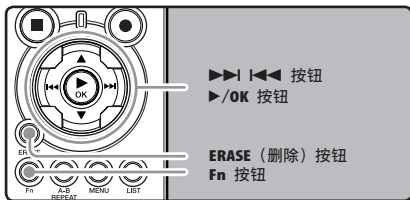

1 在文件记录、暂停记录、播放或暂停播放期间，按下 **Fn** 按钮。

- 显示屏上出现一个号码且定位标记或临时标记将被设定。
- 即使定位或临时标记已设定，记录或播放仍继续进行，因此您可以按照同样的方式在其他位置设定定位或临时标记。

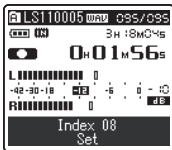

清除定位标记和临时标记：

- 1 找到您需要清除的定位标记或临时标记。
- 2 按 **▶▶▶** 或 **◀◀◀** 按钮以选择要删除的定位或临时标记。

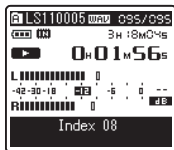

- 3 当显示屏上呈现定位标记或临时标记号码 2 秒过程中，按 **ERASE** 按钮。

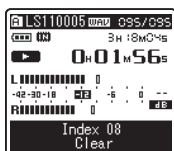

- 定位标记或临时标记即被删除。
- 已删除的定位或临时标记号码后面的定位或临时标记号码将自动升位。

备注

- 定位标记可以在本录音机进行 PCM 录音时添加，或者添加到使用本录音机记录的 PCM 文件中。

- 临时标记是临时记号，因此当您移动到另一个文件、切换到清单屏幕或将录音机连接到电脑时，这些标记将被自动删除。
- 每个文件最多可以设定 16 个定位和临时标记。如果您要放置更多定位和临时标记，对于定位标记将出现 **[Index Full]** 信息，对于临时标记将出现 **[Temp Mark Full]** 信息。
- 您无法设定或删除锁定文件中的定位或临时标记 (参 第 47 页)。

如何开始片段重复播放

该功能可在播放文件过程中重复播放文件的一部分。

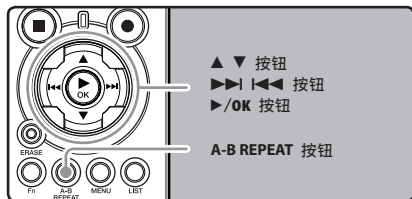

- 1 选择包含要重复播放的片段的文件 (参 第 19 至 21 页)。
- 2 在文件清单显示中，按 **▲** 或 **▼** 按钮选择文件。
 - 在文件显示中，按 **▶▶▶** 或 **◀◀◀** 按钮选择文件。
- 3 按 **▶/OK** 按钮以开始播放。

4 在您要开始片段重复播放的位置按 **A-B REPEAT** 按钮。

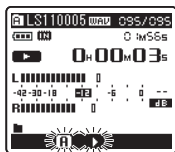

[**A-B REPEAT**] 将在显示屏上闪烁。

- [**A-B REPEAT**] 在闪烁时, 快进和快倒 (☞ 第 29 页) 也可以和在常规播放时一样进行操作, 并且可以快速到达结束位置 (☞ 第 34 页)。
- 当 [**A-B REPEAT**] 闪烁的情况下到达文件结束位置时, 这个位置会成为结束位置, 重复播放开始。

5 在您要结束片段重复播放的位置再次按 **A-B REPEAT** 按钮。

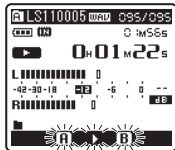

- 录音机重复播放这个片段直至片段重复播放被取消。

取消片段重复播放功能

按下列任一按钮, 可取消片段重复播放。

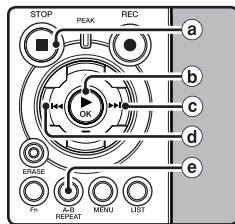

- 按 **STOP** 按钮
按 **STOP** 按钮将取消片段重复播放, 并停止播放。
- 按 **▶/OK** 按钮
按 **▶/OK** 按钮将取消片段重复播放, 并停止播放。
- 按 **▶▶** 按钮
按 **▶▶** 按钮将取消片段重复播放, 并快进到下一个文件的开始端。
- 按 **◀◀** 按钮
按 **◀◀** 按钮将取消片段重复播放, 并倒退到当前文件的开始端。
- 按 **A-B REPEAT** 按钮
按 **A-B REPEAT** 按钮将取消片段重复播放, 并开始不重复地继续播放。

3 按 ▲ 按钮以选择 [All Erase]。

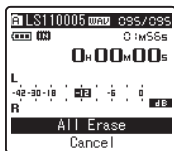

4 按 ►/OK 按钮。

- 显示屏将改变为 [All Erase!], 开始执行删除功能。当显示 [Erase Done], 文件即被删除。

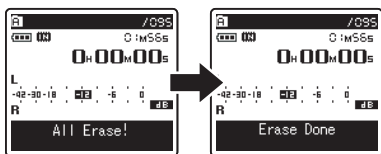

部分删除一个文件

只能部分删除录音机中记录的 PCM 文件。

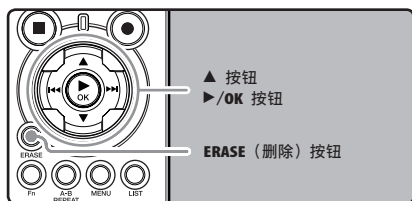

3

关于播放

1 请选择包含要部分删除文件的文件夹 (参见第 19 到 21 页)。

2 在文件清单显示中, 按 ▲ 或 ▼ 按钮选择要部分删除的文件。

- 在文件显示中, 按 ►► 或 ◀◀ 按钮选择文件。

3 播放您想部分删除的文件。

- 前进至打算删除的位置。如果文件很长, 使用 ►► 按钮移动至您想删除的位置。

4 在部分删除的开始位置, 按下 ERASE (删除) 按钮。

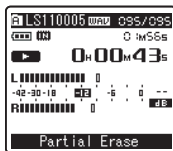

[Partial Erase] 将在显示屏上闪烁。

5 再次按下 ERASE (删除) 按钮。

- [Partial Erase Start Position] (部分删除开始位置) 和 [Partial Erase End Position] (部分删除结束位置) 将在画面上交替闪烁。在指示灯闪烁时, 继续回放, 且您可以像往常那样进行快倒或者快进并快进至删除结束。在指示灯闪烁期间, 如果文件到达末尾, 这将是删除结束的位置。

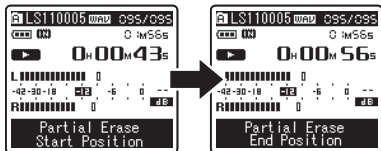

6 在要结束部分删除的位置, 再次按下 ERASE (删除) 按钮。

- 显示屏将切换为 [File Erase!], 并开始部分删除。在显示 [Partial erase completed] (部分删除完成) 时, 删除完成。
- 回放将在部分删除的结束位置停止。

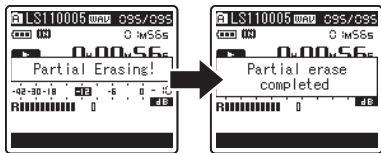

备注

- 部分删除不适用于采用 WMA 或 MP3 格式记录的文件。
- 即使文件被部分删除, 文件建立日期也不会变化。
- 无法恢复已删除的文件。在 SD 卡插入录音机后, 请务必确认记录媒体为 [Built-in Memory] (内置内存) 或 [SD Card] (SD 卡), 以免发生错误 (参 第 41、46 页)。
- 在 SD 卡被写保护的情况下尝试执行诸如重写 SD 卡的内容等操作时, 将显示 [SD Card Locked]。可以进行播放操作, 但在覆盖卡上的内容时, 必须先关闭写保护 (参 第 18 页)。
- 已锁定的文件和已设定为只读的文件无法删除 (参 第 41、47 页)。
- 如果 8 秒内未选择任何动作, 录音机将返回到停止状态。
- 请勿在处理时进行下列操作, 否则数据可能损毁。另外, 请更换两节新电池, 确保电量不会在处理过程中用尽。
 - ① 在处理过程中关闭电源。
 - ② 在处理过程中取出电池。
 - ③ 使用 [SD Card] 作为记录媒体时, 在处理过程中取出 SD 卡。
- 进行上述任意操作将损毁数据。
- 无法删除录音机上的文件夹。

菜单设定

菜单设定方法

菜单项目是通过标签分类，因此首先选择标签再移到希望的项目进行快速设定。您可以按如下所示方式设定每个菜单项目。

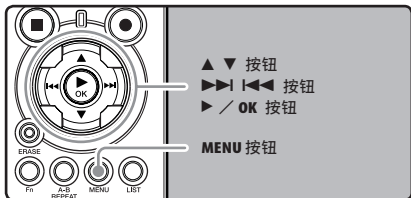

1 在录音机处于停止模式时按下 **MENU** 按钮。

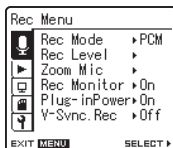

菜单将出现在显示屏上

- 您可以在录音或播放过程中设定菜单项目 (见第 50 页)。

2 按 **▲** 或 **▼** 按钮，移动到包含您要设定的项目的标签。



- 移动设定标签光标，可以变更菜单显示。

3 按 **▶/OK** 或 **▶▶|** 按钮，将光标移动到要设定的项目。



4 按 **▲** 或 **▼** 按钮，移动到您要设定的项目。

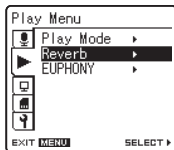

5 按 **▶/OK** 或 **▶▶|** 按钮。



- 移动到选择项目的设定

6 按 ▲ 或 ▼ 按钮，更改设定。

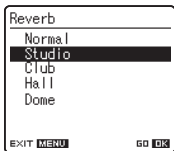

7 按 ►/OK 按钮，完成设定。



- 屏幕上将显示设定已完成的信息。
- 按 ◀◀ 按钮，而不按 ►/OK 按钮，将取消设定，返回上一个画面。

8 按 MENU 按钮以关闭菜单。

- 录音或播放时，在菜单画面上按 ◀◀ 或 MENU 按钮将可返回播放画面，不会中断录音或播放。

备注

- 未应用选定项目时，若在菜单设定操作中闲置 3 分钟，录音机将停止。
- 在录音或播放时进入菜单设定，若经过 8 秒没有按任何按钮，菜单设定将会取消。

■ Rec Menu

<h3>Rec Mode</h3>	<p>录音机可以线性 PCM 格式录音。可以在高采样频率和高位率实施高分辨率录音，其效果等于或胜过音乐 CD。此外，其也支持 MP3 和 WMA 格式。</p> <ol style="list-style-type: none"> 选择记录格式。 设定： [PCM]：这是一个未压缩的音频格式，用于音乐 CD 等类似介质。 [MP3]：MP3 是 ISO（国际标准化组织）工作组建立的国际标准。 [WMA]：这是美国微软公司开发的一种音频压缩编码方法。 选择记录速率。 设定： [PCM]：[96kHz/24bit] 到 [44.1kHz/mono] [MP3]：[320kbps] 到 [mono] [WMA]：[160kbps] 到 [mono] <ul style="list-style-type: none"> 记录格式设定为 MP3 或 WMA 格式时，采样频率将以 44.1 kHz 进行编码和处理。 使用高记录速率设定时，文件容量将增大。请在录音前确保剩余内存量足够（见第 46 页）。 如果使用定向麦克风功能，则无法将 [Rec Mode] 中的 [PCM] 设定更改为 [44.1kHz/16 bit] 以外的项。可以使用 [Rec Mode] 中 [MP3] 或 [WMA] 的所有模式。 选择了 [MP3] 的 [mono] 时，记录速率将设定为 64kbps。 选择了 [WMA] 的 [mono] 时，记录速率将设定为 32kbps。
<h3>Rec Level</h3>	<p>可以详细设定自动或手动调整录音电平。</p> <ol style="list-style-type: none"> 选择录音电平设定。 设定： [Manual]：通过手动调节录音电平进行录音。[Rec Level] 设为 [Manual] 时，可以详细设定限幅器功能。 [Auto]：通过自动调节录音电平进行录音。这在您需要立即录音时很有帮助。 选择限幅器设定。 本录音机配备限幅器功能，如果突然捕获到很大的噪音，能够将录音电平降低，修正到适当的范围内。这样可以防止录音电平过高引起扭曲。 设定： [Limiter On]：启用限幅器功能，从而防止录音时出现扭曲。 [Limiter Off]：禁用此功能。 <ul style="list-style-type: none"> [Rec Level] 设为 [Auto] 时，将自动调整录音电平。使用录音电平调整功能和限幅器功能将 [Rec Level] 设为 [Manual]。
<h3>变焦麦克风</h3>	<p>定向麦克风功能使用 DiMAGIC (DiMAGIC Co., Ltd.) 的 DiMAGIC Virtual Microphone (DVM) 技术。DVM 是一个音频拾音系统，可使您从任意方向集中录音。从扩张立体声录音到高定向录音，DVM 代表了定向控制方法的最新发展，可使您切换到单独唯一的麦克风。</p> <p>设定： [Off]：以自然立体声录音。 [Wide]：以扩张立体声录音。 [Standard]：在前方以轻微的定向立体声录音。 [Narrow]：以定向立体声录音。 [Zoom]：以高定向声音录音。（单声道录音）</p> <ul style="list-style-type: none"> 定向麦克风功能设计为只在内置立体声麦克风启动。请注意，使用其他市售麦克风时，录音机将无法正常录音。 仅能在 [Rec Mode] 中的 [PCM] 设定为 [44.1kHz/16 bit] 时使用定向麦克风。

■ Rec Menu (续)

<h3>Rec Monitor</h3>	<p>选择进行录音时是否从耳机插孔输出音频。</p> <p>设定:</p> <p>[On]: 启用录音监听功能。将从 EAR 插孔输出声音。</p> <p>[Off]: 禁用此功能。不从 EAR 插孔输出声音。</p> <ul style="list-style-type: none"> 如果在录音时连接外部扬声器, 则会产生音频反馈的风险。建议使用耳机进行录音监听, 或者在录音时将 [Rec Monitor] 设为 [Off] (☞ 第 27 页)。 当 [Rec Monitor] 设为 [Off] 的情况下, 录音时将不会从耳机发出声音 (☞ 第 27 页)。
<h3>Plug-inPower</h3>	<p>也可使用支持插入式电源的外接麦克风。可以详细设定是否向外接麦克风供电。</p> <p>设定:</p> <p>[On]: 启动插入式电源功能时, 将向连接的外接麦克风供电。当连接了支持插入式电源的外接麦克风时请选择此项 (☞ 第 30 页)。</p> <p>[Off]: 禁用此功能。当连接了不支持插入式电源的外接麦克风时请选择此项。</p> <ul style="list-style-type: none"> 如果连接了不支持插入式电源功能的外接麦克风, 请将插入式电源功能设为 [Off], 否则录音时可能会产生噪音。 即使将插入式电源功能设为 [On] 时, 也不可供入幻象电源。
<h3>V-Sync. Rec</h3>	<p>检测到语音高于语音同步水平 (检测水平) 时, 开始语音同步录音。语音变小时自动停止录音。语音同步录音开启且语音低于语音同步水平 (检测水平) 的时间超过指定的检测时间时, 录音机停止。</p> <p>设定:</p> <p>[On]: [1 second] [2 seconds] [3 seconds] [4 seconds] [5 seconds] [10 seconds]: 设定检测时间。如果输入 (录音电平) 等于或低于指定电平的时间超过指定的检测时间时, 录音机停止。</p> <p>[Off]: 禁用此功能。</p>

■ Play Menu

Play Mode	<p>有六种播放模式。可以选择按文件或文件夹播放，或播放录音机中存储的所有文件。</p> <p>设定： [File]：播放当前文件后停止。 [File Repeat]：重复播放当前文件。 [Folder]：在当前文件夹连续播放文件直到最后一个文件，然后停止。 [Folder Repeat]：连续播放当前文件夹中的所有文件。 [All]：连续播放所选存储器中的所有文件，然后停止。 [All Repeat]：连续且重复地播放所选存储器中的所有文件。</p> <ul style="list-style-type: none"> 在 [File] 模式中，当录音机到达文件夹中最后一个文件的末尾时，[End] 在显示屏上闪烁 2 秒，录音机停止在最后一个文件的开始端。 在 [Folder] 模式中，当录音机到达文件夹中最后一个文件的末尾时，[End] 在显示屏上闪烁 2 秒，录音机停止在文件夹中第一个文件的开始端。 在 [All] 模式中，文件夹中最后一个文件播放完毕后，录音机将从下一个文件夹的第一个文件开始播放。当到达录音机中的最后一个文件的末尾时，[End] 在显示屏上闪烁 2 秒，录音机停止在本录音机中第一个文件的开始端。
Reverb	<p>可以欣赏小至录音室大至体育场各种空间大小的混响声音。</p> <p>设定： [Normal]：禁用此功能。原样播放原始声音时选择此项。 [Studio] [Club] [Hall] [Dome]：选择符合喜好的音响环境。</p> <ul style="list-style-type: none"> 使用这些效果播放 WAV 格式的文件时，采样频率与位率将分别从 96 kHz 下调至 48 kHz，从 24 bit 下调至 16 bit。 此功能仅在播放时可用。本录音机不能使用这些播放效果进行录音。 在录音机上调节与播放相关的各种音质设定时，从 EAR 插孔发出的音频输出讯号也将随之变更。
EUPHONY	<p>本录音机配备有“EUPHONY MOBILE”，结合了频宽修正、扩展技术和虚拟声源处理技术的最新的环绕音响系统。除了自然、广阔的感觉之外，录音机还具备有特殊功能，使听众不会轻易产生压抑或封闭的感觉，长时间收听也不会感到疲劳。根据性能，[EUPHONY] 设定的电平调节可设为四级。</p> <p>设定： [Normal]：禁用此功能。原样播放原始声音时选择此项。 [Natural]：此模式实现了自然频宽修正和声场扩展。 [Wide]：此模式可享有更广阔的感觉。 [Power]：此模式更注重重音频力量感。</p> <ul style="list-style-type: none"> 使用这些效果播放 WAV 格式的文件时，采样频率与位率将分别从 96 kHz 下调至 48 kHz，88.2kHz 下调至 44.1kHz，从 24 bit 下调至 16 bit。 此功能仅在播放时可用。本录音机不能使用这些播放效果进行录音。 在录音机上调节与播放相关的各种音质设定时，从 EAR 插孔发出的音频输出讯号也将随之变更。

■ LCD / Sound Menu

Back light	<p>当按录音机上的按钮时，显示屏会亮起约 10 秒钟（预设）。</p> <p>设定： [5 seconds] [10 seconds] [30 seconds] [60 seconds] [Always on]： 设定背光亮灯时间。 [Off]：禁用此功能。背光不会点亮。</p>
Contrast	<p>显示对比度可进行 12 级调节。</p> <p>设定： 您能调节 LCD 显示对比度级从 [01] 到 [12]。</p>
LED	<p>您可以进行设定以使 LED 指示灯熄灭。</p> <p>设定： [On]：LED 指示灯被设定。 [Off]：禁用此功能。LED 指示灯被取消。</p>
Language	<p>可以为本录音机选择显示语言。</p> <p>设定： [English] [Français] [Deutsch] [Italiano] [Español] [Русский]</p> <ul style="list-style-type: none"> 不同的地区可选择不同的语言。

■ Memory Menu

内存选择 [MemorySelect]	<p>在插入 SD 卡后，您可以选择记录至内置闪存还是 SD 卡（☞ 第 14 页）。</p> <p>设定： [Built-in Memory]：内置闪存。 [SD Card]：SD 卡。</p> <ul style="list-style-type: none"> 在 SD 卡被写保护的情况下尝试执行诸如重写 SD 卡的内容等操作时，将显示 [SD Card Locked]。可以进行播放操作，但在覆盖卡上的内容时，必须先关闭写保护（☞ 第 18 页）。
存储信息 [Memory Info.]	<p>可以在菜单画面上检视记录媒体剩余的可记忆容量和总体容量。</p> <ul style="list-style-type: none"> 没有插入 SD 卡时，只能看到内置闪存的信息。 录音机使用的管理文件所在的域包含在记录媒体的剩余容量中。对于 SD 卡，除了管理域，也会添加 SD 卡的管理域。因此，显示的剩余容量可能低于卡指定的容量，这是正常的。
录音机格式化 [Format]	<p>（☞ 第 51 页）</p>

■ Others

锁定 [Lock]	<p>锁定文件可保护重要数据不被意外删除。当选择从文件夹中删除所有文件时锁定文件不会被删除 (☞ 第 38 页)。</p> <p>设定: [On]: 锁定文件防止被删除。 [Off]: 禁用此功能。解除文件的锁定, 允许被删除。</p> <ul style="list-style-type: none"> 在 SD 卡被写保护的情况下尝试执行诸如重写 SD 卡的内容等操作时, 将显示 [SD Card Locked]。可以进行播放操作, 但在覆盖卡上的内容时, 必须先关闭写保护 (☞ 第 18 页)。
重新编排文件 [Replace]	(☞ 第 54 页)
文件移动 [File Move]	(☞ 第 56 页)
文件分割 [File Divide]	(☞ 第 59 页)
自动关闭 [AutoPowerOff]	<p>可以防止忘记关闭电源。如果录音机在电源开启时处于停止模式超过 10 分钟以上(预设), 电源将关闭。</p> <p>设定: [5 minutes] [10 minutes] [30 minutes] [60 minutes] 设定电源关闭前的时间。 [Off]: 禁用此功能。</p> <ul style="list-style-type: none"> 如果在电源关闭之前按下任意按钮, 则经过时间将重新开始计时。
USB 类型 [USB Settings]	<p>使用附带的 USB 线缆将录音机连接到计算机时有两种 USB 设定。[Storage Class] 在录音机作为外部存储设备时利用。[Audio Class] 在录音机用作 USB 麦克风时利用。</p> <p>设定: [Storage Class]: 从计算机确认为外部记忆装置时。 [Audio Class]: 录音机连接至计算机并用作 USB 麦克风时。</p>
设定时间 / 日期 [Time & Date]	(☞ 第 15 页)

■ Others (续)

Fn 设置 [Fn Setting]

当 **Fn** 按钮中登录了各种功能时，每次按 **Fn** 按钮都可设置或改变登录功能的菜单。

设定：

[Off]：没有功能分配给该按钮。

[Index] (☞ 第 35 页)

[Rec Level]： (☞ 第 43 页)

[Play Mode] (☞ 第 45 页)

[EUPHONY] (☞ 第 45 页)

[Property] (☞ 第 49 页)

[Rec Mode] (☞ 第 43 页)

[Zoom Mic] (☞ 第 43 页)

[Reverb] (☞ 第 45 页)

[MemorySelect] (☞ 第 46 页)

[Light] (☞ 第 46 页)

调用登录的功能：

按下 **Fn** 按钮时，登录功能的菜单设置显示会出现：

[Rec Mode]：

[PCM] [MP3] [WMA]：可为每种文件格式配置记录速率。

[Rec Level]：

[Manual] [Auto]：可以详细设定自动或手动调整录音电平。

[Rec Level] 设定为 [Manual] 时，可以配置限幅器功能。

[Zoom Mic]：

[Off] [Wide] [Standard] [Narrow] [Zoom]

[Play Mode]：

[File] [File Repeat] [Folder] [Folder Repeat] [All]

[All Repeat]

[Reverb]：

[Normal] [Studio] [Club] [Hall] [Dome]

[EUPHONY]：

[Normal] [Natural] [Wide] [Power]

[MemorySelect]：

[Built-in Memory] [SD card]

[Property]：

通过菜单画面可以配置文件和文件夹信息。

每按一次 **Fn** 按钮，登录的功能设定都会变化：

[Light]：

[On] [Off]：通过按 **Fn** 按钮选择背光开或关。

如果在录音或播放期间按下 **Fn** 按钮，将执行登录的功能：

[Index]：

每按一次 **Fn** 按钮，就会加上一个定位标记或临时标记。

- 当登录功能为 [Rec Mode]、[MemorySelect] 或 [Property] 时，在录音和播放期间如果按下 **Fn** 按钮则无效。请在录音机停止模式期间按 **Fn** 按钮。

■ Others (续)

菜单重设 [Menu Reset]	<p>可将功能恢复为初始设定（出厂预设）。</p> <p>设定： [Start]：使设定回到初始值。 [Cancel]：返回 [Others]。</p> <ul style="list-style-type: none"> 重设后，时间设定及文件编号将保留重设前的设定，不会回到初始设定。 <p>重设（初始设定）后的菜单设定：</p> <table border="0"> <tr> <td> ■ Rec Menu [Rec Mode] Recording format [PCM] Recording rate [44.1kHz/16bit] [Rec Level] Recording level [Manual] Limiter function [Limiter On] [Zoom Mic] [Off] [Rec Monitor] [On] [Plug-inPower] [On] [V-Sync.Rec] [Off] </td> <td> ■ LCD/Sound Menu [Backlight] [10 seconds] [Contrast] [06] [LED] [On] </td> <td> ■ Memory Menu [MemorySelect] [Built-in Memory] </td> </tr> <tr> <td> ■ Play Menu [Play Mode] [File] [Reverb] [Normal] [EUPHONY] [Normal] </td> <td> ■ Other [AutoPowerOff] [10 minutes] [USB Settings] [Storage] [Fn Setting] [Off] </td> <td></td> </tr> </table>	■ Rec Menu [Rec Mode] Recording format [PCM] Recording rate [44.1kHz/16bit] [Rec Level] Recording level [Manual] Limiter function [Limiter On] [Zoom Mic] [Off] [Rec Monitor] [On] [Plug-inPower] [On] [V-Sync.Rec] [Off]	■ LCD/Sound Menu [Backlight] [10 seconds] [Contrast] [06] [LED] [On]	■ Memory Menu [MemorySelect] [Built-in Memory]	■ Play Menu [Play Mode] [File] [Reverb] [Normal] [EUPHONY] [Normal]	■ Other [AutoPowerOff] [10 minutes] [USB Settings] [Storage] [Fn Setting] [Off]	
■ Rec Menu [Rec Mode] Recording format [PCM] Recording rate [44.1kHz/16bit] [Rec Level] Recording level [Manual] Limiter function [Limiter On] [Zoom Mic] [Off] [Rec Monitor] [On] [Plug-inPower] [On] [V-Sync.Rec] [Off]	■ LCD/Sound Menu [Backlight] [10 seconds] [Contrast] [06] [LED] [On]	■ Memory Menu [MemorySelect] [Built-in Memory]					
■ Play Menu [Play Mode] [File] [Reverb] [Normal] [EUPHONY] [Normal]	■ Other [AutoPowerOff] [10 minutes] [USB Settings] [Storage] [Fn Setting] [Off]						
系统信息 [System Info.]	<p>您可以从菜单屏幕上查看录音机的信息。[Model Name]（型号名称）、[Version]（系统版本）和 [Serial Number]（序号）会出现在显示屏上。</p>						
属性 [Property]	<p>可以从菜单屏幕确认文件和文件夹信息。</p> <p>选择文件时：[Name] [Date] [Size] [Length] 和 [File Format] 会出现在显示屏上。</p> <p>选择文件夹时：[Name] 和 [Date] 会出现在显示屏上。</p> <ul style="list-style-type: none"> 选择在操作菜单前希望事先确认其信息的文件。 						

◆ 录音时的设定菜单

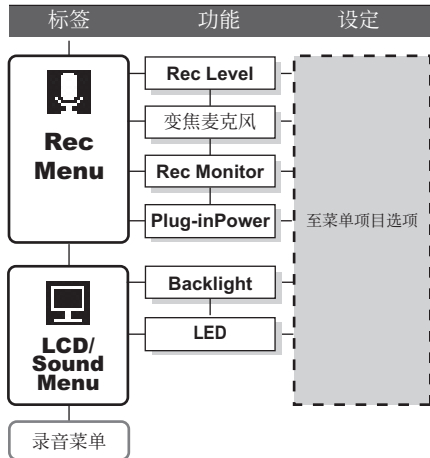

◆ 播放时的设定菜单

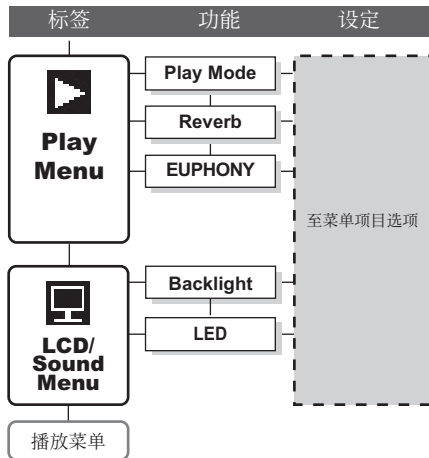

录音机格式化 [Format]

如果您格式化录音机，所有文件都将被删除，除日期和时间设定外的所有功能设定都将返回到预设状态。格式化录音机之前，请将重要文件传送到计算机中保存。

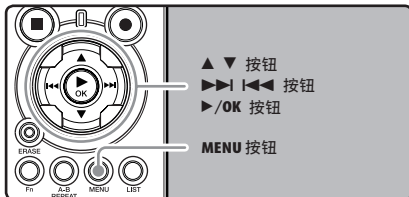

1 在录音机处于停止模式时按下 **MENU** 按钮。

- 菜单将出现在显示屏上 (☞ 第 41 页)。

2 按 **▲** 或 **▼** 按钮，选择 [**Memory Menu**] 标签。

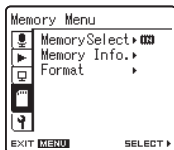

- 移动设定标签光标，可以变更菜单显示。

3 按 **▶/OK** 或 **▶▶▶** 按钮，将光标移动到要设定的项目。



[**Memory Menu**] 将出现在显示屏上

4 按 **▲** 或 **▼** 按钮选择 [**Format**]。

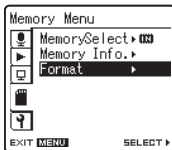

5 按 **▶/OK** 或 **▶▶▶** 按钮。



[**Format**] 将出现在显示屏上

6 按 **▲** 或 **▼** 按钮选择要格式化的记录媒体。

- 格式化 SD 卡时，在插卡进录音机前取消写保护功能。(☞ 第 18 页)。

7 按 **▶/OK** 按钮。

[Cancel] 将出现在显示屏上

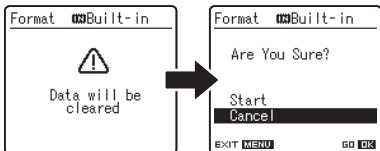
8 按 **▲** 按钮以选择 [Start]。9 按 **▶/OK** 按钮。

- [Data will be cleared] 信息显示 2 秒后，[Cancel] 将开启。

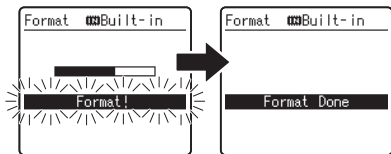
10 再次按 **▲** 按钮以选择 [Start]。11 按 **▶/OK** 按钮。

- 开始格式化并且 [Format!] 在显示屏上闪烁。
- 显示 [Format Done] 时格式化完毕。

备注

- 在 SD 卡插入录音机后，请务必确认记录媒体为 [Built-in Memory] (内置内存) 或 [SD Card] (SD 卡)，以免发生错误 (☞ 第 41、46 页)。
- 在 SD 卡被写保护的情况下尝试执行诸如重写 SD 卡的内容等操作时，将显示 [SD Card Locked]。可以进行播放操作，但在覆盖卡上的内容时，必须先关闭写保护 (☞ 第 18 页)。
- 请勿在处理时进行下列操作，否则数据可能损毁。另外，请更换两节新电池，确保电量不会在处理过程中用尽。
 - ① 在处理过程中关闭电源。
 - ② 在处理过程中取出电池。
 - ③ 使用 [SD Card] 作为记录媒体时，在处理过程中取出 SD 卡。
 进行上述任意操作将损毁数据。
- 千万不要将本机在电脑上格式化。
- 录音机一旦格式化，将无法再将具有 DRM 的音乐文件传送到录音机。

- 当录音机被格式化时，所有保存的数据，包括锁定的文件和只读文件都会被删除。
- 格式化后，所记录的音频文件名称可以从 [0001] 开始。
- 要使功能设定返回到初始设定时，请使用 [Menu Reset] (☞ 第 41、49 页)。
- 录音机上的格式化是“快速格式化”。如果您对 SD 卡执行格式化，文件管理中的信息将被重新整理，且 SD 卡中的数据不会完全删除。在转让和处置 SD 卡时，小心 SD 卡中的数据泄漏。我们建议在您处置 SD 卡时，将其销毁。

重新编排文件 [Replace]

您可以移动文件夹中的文件以便更改播放顺序。
首先选择您要更改播放顺序的文件夹（文件）。

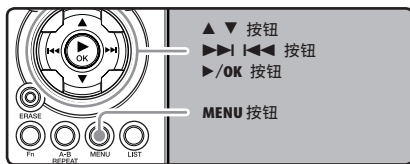

1 选择文件夹，重新整理歌曲顺序（☞ 第 17 到 21 页）。

2 在录音机处于停止模式时按下 **MENU** 按钮。

- 菜单将出现在显示屏上（☞ 第 41 页）。

3 按 ▲ 或 ▼ 按钮，选择 **[Others]** 标签。



- 移动设定标签光标，可以变更菜单显示。

4 按 ▶/OK 或 ▶▶▶ 按钮，将光标移动到要设定的项目。

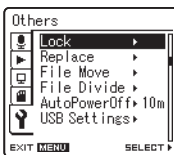

[Others] 将出现在显示屏上。

5 按 ▲ 或 ▼ 按钮以选择 **[Replace]**。

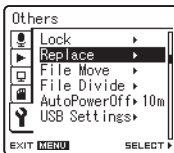

6 按 ▶/OK 或 ▶▶▶ 按钮。

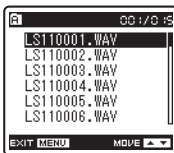

7 按 ▲ 或 ▼ 按钮以选择要移动的文件。

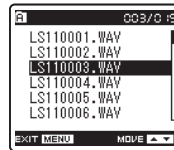

- 8 按 **▶/OK** 或 **▶▶** 按钮。
- 光标闪烁，确认文件可以移动。

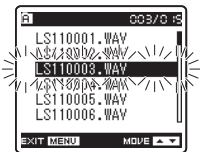

- 9 按 **▲** 或 **▼** 按钮以选择文件要移动到的位置。

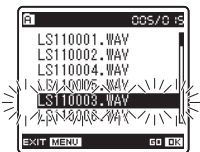

- 10 按 **▶/OK** 按钮以完成设定。

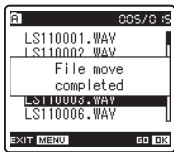

- 如果要移动更多文件，请重复步骤 7 至 10。
- 按 **◀◀** 按钮而不按 **▶/OK** 按钮，将取消设定，返回上一个画面。

- 11 按 **MENU** 按钮以关闭菜单。

备注

- 在 SD 卡被写保护的情况下尝试执行诸如重写 SD 卡的内容等操作时，将显示 [**SD Card Locked**]。可以进行播放操作，但在覆盖卡上的内容时，必须先关闭写保护（见第 18 页）。

文件移动 [File Move]

内置内存或 SD 卡中保存的文件可以在内存内移动或复制。文件也可以在内存之间移动或复制。

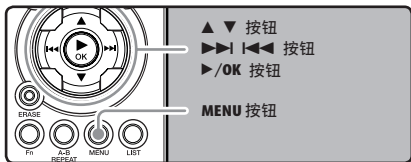

1 选择您想要移动或复制之文件所在的文件夹。

2 在文件清单显示中，按 ▲ 或 ▼ 按钮选择要移动或复制的文件。

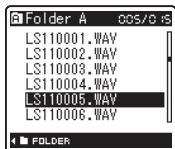

- 在文件显示中，按 ▶▶ 或 ◀◀ 按钮选择文件。

3 在录音机处于停止模式时按下 MENU 按钮。

- 菜单将出现在显示屏上 (☞ 第 41 页)。

4 按 ▲ 或 ▼ 按钮，选择 [Others] 标签。

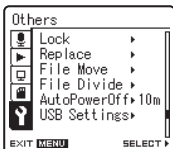

- 移动设置标签光标，可以变更菜单显示。

5 按 ▶/OK 或 ▶▶ 按钮，将光标移动到要设定的项目。

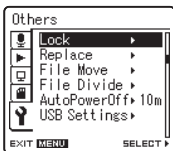

6 按 ▲ 或 ▼ 按钮，选择 [File Move] 。

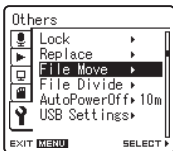

7 按 ►/OK 或 ►►► 按钮。



[File Move] 将出现在显示屏上

8 按 ▲ 或 ▼ 按钮，选择移动或复制文件的目的地位置。

[Move to Built-in]:

将内置内存或 SD 卡中的文件移动到内置内存内的另一个文件夹。

[Copy to Built-in]:

将内置内存或 SD 卡中的文件复制到内置内存内的另一个文件夹。

[Move to SD Card]:

将内置内存或 SD 卡中的文件移动到 SD 卡内的另一个文件夹。

[Copy to SD Card]:

将内置内存或 SD 卡中的文件复制到 SD 卡内的另一个文件夹。

9 按 ►/OK 或 ►►► 按钮。

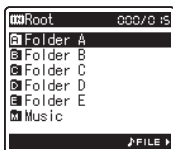

显示移动或复制文件夹选择画面。

10 按 ▲ 或 ▼ 按钮，选择您要移动或复制文件的目的地文件夹。

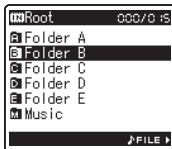

11 按 ►/OK 按钮，完成设定。

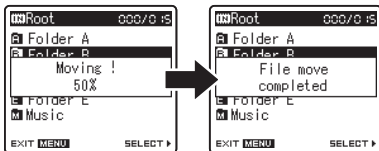

- [Moving!] (正在移动!) 或 [Copying!] (正在复制!) 将出现在显示屏上，并将开始移动或复制。在此期间，将以百分数的形式，显示进度状态。在显示 [File move completed] (文件移动完成) 或 [File copy completed] (文件复制完成) 时，过程结束。

12 按 MENU 按钮以关闭菜单。

备注

- 在内存空间不足时，录音机将无法复制。
- 在文件数超过 199 个时，录音机无法移动或复制文件。
- 在移动或复制文件过程中，请勿取下电池。否则，将导致资料受损。
- 文件无法移动或复制到相同的文件夹。
- 当有相同名称的文件在移动/复制目标文件夹中，会显示 [**Cannot move.Same name file exists**] 或 [**Cannot copy.Same name file exists**]。文件不会被覆盖。
- 在移动或复制过程中，取消操作时，移动或复制将被取消。
- 锁定的文件在移动或复制后仍将被锁定。
- SD 卡处于写保护时，若要试图重写 SD 卡的内容，将出现 [**SD Card Locked**]。可以进行播放操作，但在覆盖卡上的内容时，必须先关闭写保护 (☞ 第 18 页)。
- DRM 文件无法进行移动或复制。
- 文件不能直接在 [**Root**] 文件夹下移动或复制。

文件分割 [File Divide]

可以分割录音机中记录的 PCM 文件。
较大容量和记录时间较长的文件可以进行分割，
以便更容易管理和编辑。

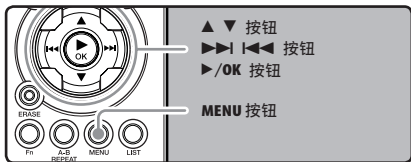

1 选择您想要分割的 PCM 文件，播放文件
或快进，并在您想要分割的文件地方停
下来。

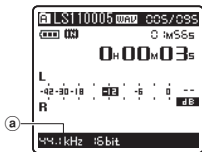

• 带有 [96kHz]、[88.2kHz]、[48kHz] 或 [44.1kHz]
记录模式的文件是在 PCM 格式记录的文件。

a 录音模式

2 在录音机处于停止模式时按下 **MENU** 按
钮。

• 菜单将出现在显示屏上 (☞ 第 41 页)。

3 按 ▲ 或 ▼ 按钮，选择 [Others] 标签。

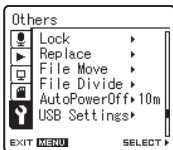

• 移动设定标签光标，可以变更菜单显示。

4 按 ▶/OK 或 ▶▶ 按钮，将光标移动到
要设定的项目。



[Others] 将出现在显示
屏上

4

菜单设定

5 按 ▲ 或 ▼ 按钮，选择 [File Divide] 。

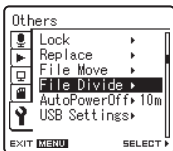

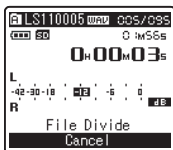
6 按 \blacktriangleright /OK 或 $\blacktriangleright\blacktriangleright$ 按钮。

[File Divide] 将出现在显示屏上。

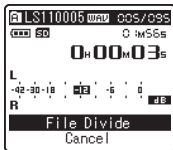
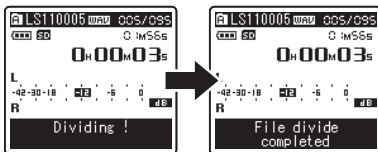
7 按 \blacktriangle 或 \blacktriangledown 按钮，选择 [File Divide]。8 按 \blacktriangleright /OK 或 $\blacktriangleright\blacktriangleright$ 按钮。

- 将显示 [Dividing!]，并开始分割文件。在显示 [File divide completed] 时，分割完成。

9 按 MENU 按钮以关闭菜单。

备注

- 在显示文件清单时，无法完成文件分割。
- 在文件夹中的文件数量超过 199 时，录音机无法分割文件。
- 锁定的文件 (第 41、47 页) 无法进行分割。
- 在分割了一个文件后，源文件将被重新命名为 [File name_1.WAV]，且新的文件将命名为 [File name_2.WAV]。
- 分割文件生成的文件保留原始文件的创建日期和修改日期。
- 如果一个文件的记录时间很短，即使其是 PCM 文件，也可能无法分割。
- 在分割文件过程中，请勿取出电池。这可能导致数据受损。

在您的计算机上使用录音机

将录音机连接到个人计算机后，您可进行下列操作：

- 可转移本录音机记录的文件到计算机中、播放、利用 Windows Media Player 或 iTunes 管理（☞ 第 65、72 页）。
- 除用作 IC 录音机和音乐播放器外，本录音机还可以用作计算机的外部存储器，存储和读取计算机数据（☞ 第 64、76 页）。

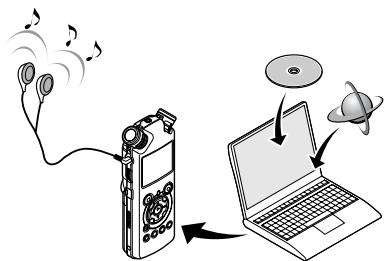

操作环境

Windows

操作系统：

Microsoft Windows XP/Vista（标准安装）

兼容个人电脑：

装配一个以上空 USB 端口的 Windows PC

Macintosh

操作系统：

Mac OS X 10.4.11 - 10.5（标准安装）

兼容个人电脑：

装配一个以上空 USB 端口的苹果 Macintosh 系列

备注

- 在这个操作环境中，可用 USB 连接，将录音机录音的文件储存在个人电脑。
- 要检查 [Olympus Sonority] 软件的操作环境，请参阅附属表单。
- 即使符合操作环境的要求，但若是 64-bit 操作系统、多重开机环境及自行改装的个人电脑，仍不受支持。
- 即使符合操作环境的要求，但若是 64-bit 操作系统、多重开机环境及自行改装的个人电脑，仍不受支持。

录音机

连接到个人电脑使用时的注意事项

- 当您正在从录音机下载文件或将文件上传到录音机时，切勿拔下 USB 线缆，即使屏幕指示您可以拔取。[PEAK] 指示灯闪烁时数据传送仍在进行。拔下 USB 线缆时，请一定参照 ☞ 第 63 页记载方法进行。如果不在驱动停止后再拔下 USB 线缆，数据就可能传送不成功。
- 请不要在计算机上格式化本机的驱动器。在计算机上不能被正确的初始化。关于初始化，请依照本机 [Format]（格式化）画面上的说明进行（☞ 第 51 页）。
- 使用文件管理工具（例如 Microsoft Windows 中的 Explorer）显示的文件夹（路径）名称与录音机设定的文件夹名称不同。
- 如果使用诸如 Explorer 等文件管理工具移动或重命名保存在录音机内的文件夹或文件，文件顺序可能会改变或者文件可能会变得无法识别。
- 即使在计算机的操作系统上将本机驱动器属性设定为只读，也能在本机上读写数据。
- 由于噪音可能会对录音机附近的电子设备产生不利影响，将录音机连接到个人计算机时要拔下耳机。

连接至您的个人电脑

版权和版权保护 机能 (DRM)

依据版权法，若无版权授权，坚决禁止复制及散布自网络上下载的语音或音乐文件、音乐 CD 等，禁止将其再反复上载到网上，用作商业用途或以销售为目的，将其复制成 WMA 或 MP3 文件。

关于 WMA 文件为了保护版权有时会施行 DRM 对策。施行了 DRM 对策的文件受到限制，不能再实行不正当的复制及发布从音乐 CD 转换来的或从音乐发行服务购入的音乐文件。将被施行了 DRM 对策的 WMA 文件传送到本机时需要使用 Windows Media Player 等规定的方法来传送。可能禁止将从网上音乐发行服务所购的具有 DRM 的音乐文件复制到录音机等便携式设备。

备注

- 本录音机同 Microsoft Corporation DRM9 兼容，但是不与 DRM10 兼容。

5

在 PC 上使用录音机

连接至您的个人电脑

- 1 启动个人电脑。
- 2 将 USB 连接线同计算机的 USB 端口连接。

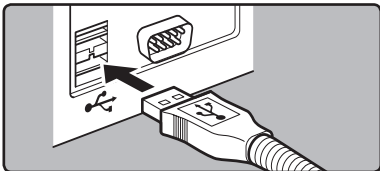

- 3 确认录音机已经停止后，将 USB 连接线同录音机侧面的连接端口相连。

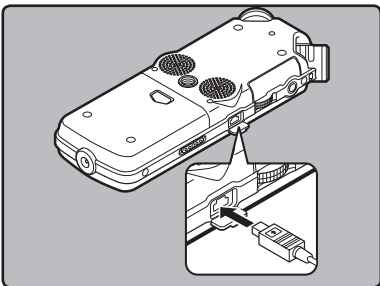

Windows:

当打开 [My Computer] 时可被识别为驱动名称 [LS_11] (内置闪存) 和 [Removable Disk] (SD 卡)。

Macintosh:

将录音机同 Mac OS 相连时，将被识别为桌面上的驱动名称 [LS_11]。当插入 SD 卡时，可被识别为驱动名称 [Untitled]。



如果连接 USB 线缆, 则 [Connect (Storage)] 会显示在录音机上。

备注

- 请务必使用随附的 USB 连接专用线。如果使用其他公司的缆线可能导致出现问题。不要连接专用缆线到其他公司的产品上。

结束与个人电脑的连接

Windows

- 单击位于屏幕右下角任务条上的 []。单击 [Safely remove USB Mass Storage Device]。

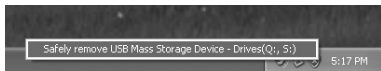

- 驱动器名会依所使用的电脑而定。

- 当出现安全地移除硬件窗口时, 单击 [OK]。

- 断开 USB 线的连接。

Macintosh

- 将桌面上出现录音机驱动器图标拖放到垃圾箱。

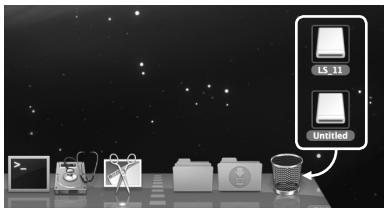

- 将录音机同 Mac OS 相连时, 将被识别为桌面上的驱动名称 [LS_11]。当插入 SD 卡时, 可被识别为驱动名称 [Untitled]。

- 中断 USB 线的连接。

备注

- 当 [PEAK] 指示灯闪烁时千万不要断开 USB 连接。否则数据可能被破坏。
- 当录音机同电脑连接时, 可由 USB 线缆提供电源。
- 参阅用户手册有关 PC 的 USB 端口的内容。
- 确保 USB 线缆直接连接到 PC 的 USB 端口。
- 请确保完全推进电缆连接线, 否则录音机可能无法正常运行。
- 当通过 USB 集线器连接录音机时, 操作可能会变得不稳定。这种情况下, 不要使用 USB 集线器。

传输声音文件到个人电脑

本录音机有 5 种声音文件夹，分别显示为 [DSS_FLDA]、[DSS_FLDB]、[DSS_FLDC]、[DSS_FLDD] 和 [DSS_FLDE]，并且记录的声音文件保存在这些文件夹中。

Windows

- 1 连接录音机到 PC (☞ 第 62 页)。
- 2 打开 Explorer 窗口。
- 3 打开 [LS_11] 文件夹。
 - 打开 [My Computer] 时可被识别为驱动名称 [LS_11] (内置闪存) 和 [Removable Disk] (SD 卡) (驱动器名会依所使用的电脑而定)。

5

在 PC 上使用录音机

- 4 复制数据。
- 5 中断录音机与 PC 的连接 (☞ 第 63 页)。

Macintosh

- 1 连接录音机到 PC (☞ 第 62 页)。
 - 将录音机同 Mac OS 相连时，将被识别为桌面上的驱动名称 [LS_11]。当插入 SD 卡时，可被识别名为驱动名称 [Untitled]。

- 2 双击桌面上的 [LS_11] 图标。
- 3 复制数据。
- 4 中断录音机与 PC 的连接 (☞ 第 63 页)。

■ 连接个人电脑时的驱动器名称和文件夹名称：

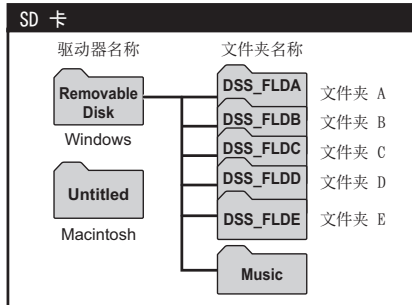
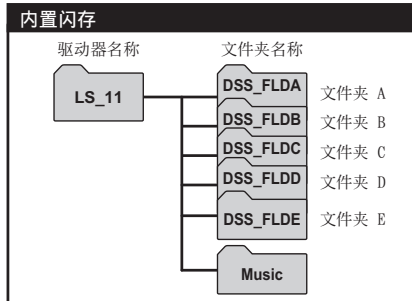

备注

- 传输数据时，会显示 [Busy]，且 [PEAK] 指示灯会闪烁。当 [PEAK] 指示灯闪烁时千万不要断开 USB 连接。否则数据可能被破坏。
- Windows 操作环境下不能播放 24 bit WAV 格式文件。
- 当电脑音效卡不支持 24 bit 时，录音机无法正确播放支持 24 bit 的软件。
- Mac OS 操作环境下，无法播放 WMA 格式文件。

使用 Windows Media Player

来自音乐 CD 或语言学习 CD 的音乐文件可以使用 Windows Media Player 导入到 PC (☞ 第 66 页), 而且从音乐发行服务购入的音乐文件可以很容易传送到录音机播放 (☞ 第 67 页)。记录在录音机的文件可以传送到 PC, 也可复制到 CD (☞ 第 70 页)。支持 WAV、MP3 和 WMA 格式的音乐文件。

窗口名

Windows Media Player 11



- ① 功能任务栏
- ② 定位滑块
- ③ 无序播放按钮
- ④ 重复按钮
- ⑤ 停止按钮
- ⑥ 上一个按钮
- ⑦ 播放按钮
- ⑧ 下一个按钮
- ⑨ 静音按钮
- ⑩ 音量滑块

Windows Media Player 10

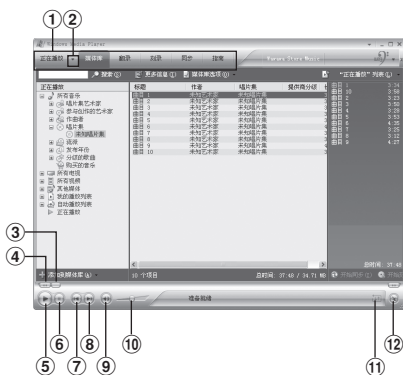

- ① 功能任务栏
- ② 快速访问面板按钮
- ③ 定位滑块
- ④ 后退按钮
- ⑤ 播放按钮
- ⑥ 停止按钮
- ⑦ 上一个按钮
- ⑧ 下一个按钮
- ⑨ 静音按钮
- ⑩ 音量滑块
- ⑪ 无序播放/重复按钮
- ⑫ 快进按钮

5

在 PC 上使用录音机

复制 CD 上的音乐

- 1 将 CD 插入 CD-ROM 驱动盘，并启动 Windows Media Player。
- 2 从功能任务栏单击 [翻录] 菜单。
 - 单击 [翻录] 菜单后，如有需要，单击 Windows Media Player 10 的 [查看唱片集信息]。
 - 如果能连接到互联网，可以进行 CD 的信息检索。
- 3 给想复制的音乐文件上加上标记。
- 4 单击 [开始翻录]。
 - 对于 Windows Media Player 10，单击 [翻录音乐]。
 - 复制到 PC 的文件以 WMA 格式保存。复制的音乐文件按作家名称、专辑、种类等分类追加到播放列表。

5

在 PC 上使用录音机

Windows Media Player 11



Windows Media Player 10

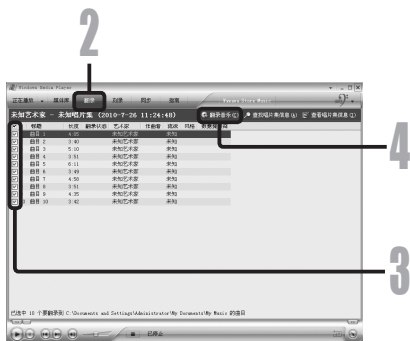

传送音乐文件至录音机

可以将保存在 PC 的音乐文件传送到录音机。有关如何从 CD 复制音乐文件到 PC，参阅“复制 CD 上的音乐”（第 66 页）。

Windows Media Player 11

1 将录音机连接到 PC，并启动 Windows Media Player。

2 从功能任务栏，单击 [同步]。

3 再次单击 [同步] 菜单选择 [PCM RECORDER] → [高级选项] → [设置同步]，并按下列步骤设置。

- 单击 [在设备上创建文件夹层次结构] 进行选择。 *1 *2
- 自动创建有艺术家或专辑名称的文件夹。这样很容易找到要听的文件。

*1 如果预设选择 [Create folder hierarchy on device]，单击取消选择，再次单击进行选择。

*2 同步传送到录音机后，会创建一个名为“WMPInfo.xml”的文件。若删除该文件，*1 需要重新设置。

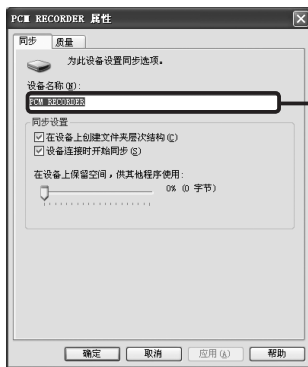

4 从左侧的 [媒体库] 选择想要的分类, 并选择音乐文件或唱片传送到录音机, 拖进右侧的 [同步列表]。

5 单击 [开始同步]。

- 文件被传送到录音机。



Windows Media Player 10

5

1 将录音机连接到 PC, 并启动 Windows Media Player。

在 PC 上使用录音机

2 从功能任务栏, 单击 [同步]。

3 从左侧窗口的下拉菜单, 选择要传送到录音机的播放目录, 并在要传送的音乐文件上加上标记。

- 拖放播放列表中的音乐文件可改变音乐文件的顺序。

4 从右侧窗口的下拉菜单, 选择对应于本录音机的驱动器。

- 录音机可看作是移动磁盘。

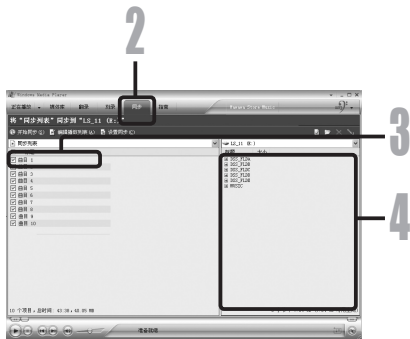

5 单击右上角的 [], 设定同步选项。

- 单击 [在设备上创建文件夹层次结构] 进行选择。*1*2
- 自动创建有艺术家或专辑名称的文件夹。这样很容易找到要听的文件。

*1 如果预设选择 [在设备上创建文件夹层次结构], 单击取消选择, 再次单击进行选择。

*2 同步传送到录音机后, 会创建一个名为“WMPInfo.xml”的文件。若删除该文件, *1 需要重新设置。

6 单击 [开始同步]。

- 文件被传送到录音机。传送到录音机的音乐文件显示在设备中的项目上。

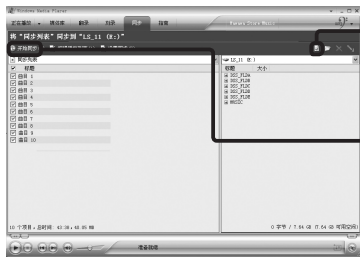

备注

- 可能禁止止将从在线音乐发行行服务所购的具有 DRM 的音乐文件复制到录音机等便携式设备。
- 要使用 Windows Media Player 9 传送文件, 查看奥林巴斯网站。
- 当录音机已达到最大存储器容量时, 若还在传送音乐文件, 则录音机的显示屏上可能会显示 [**Cannot make the system file. Connect to PC and delete unnecessary file**]。此时, 删除文件为管理文件文件留出空间 (根据音乐文件的大小而定, 从几百 KB 到几十 MB)。(管理文件所需的空空间随音乐文件数量的增加而增大)

复制声音文件到 CD

可以转移录音机的声音文件到 PC 和 CD。如何从录音机复制声音文件到 PC, 参阅“传输声音文件到个人电脑”(第 64 页)。

Windows Media Player 11

1 插入空白的 CD-R/RW 到 CD-R/RW 驱动器, 并启动 Windows Media Player。

2 从功能任务栏, 单击 [刻录] 菜单。

3 从左侧的 [媒体库] 选择希望分类, 并选择声音文件或专辑复制到 CD-R / RW, 并拖放到右侧的 [刻录列表]。

4 再次单击 [刻录] 菜单, 并选择 [音频 CD] 或 [数据 CD]。

选择 [音频 CD] 时:

- 将文件转换或复制到 CD 以便通过可以播放 CD-R / RW 的音频装置来播放。

选择 [数据 CD] 时:

- 以要录音的格式复制文件。

5 单击 [开始刻录]。



Windows Media Player 10

1 插入空白的 CD-R/RW 到 CD-R/RW 驱动器，并启动 Windows Media Player。

2 从功能任务栏，单击 [刻录] 菜单。

- 单击 [编辑播放列表] 菜单后，根据需要单击 [刻录] 菜单。
- 通过拖放文件可以改变曲目顺序。

3 在希望复制的声音文件上加上复选标记。

4 选择 CD 格式后单击 [开始刻录]。

选择 [音频 CD] 时：

- 将文件转换或复制到 CD 以便通过可以播放 CD-R / RW 的音频装置来播放。

选择 [数据 CD] 时：

- 以要录音的格式复制文件。

5 单击 [开始刻录]。



5

在 PC 上使用录音机

备注

- 可能禁止将从在线音乐发行服务所购的具有 DRM 的音乐文件复制到录音机等便携式设备。
- 有关详情，请参阅 Windows Media Player 的在线帮助。

使用 iTunes

来自音乐 CD 或语言学习 CD 的音乐文件可以使用 iTunes 导入到 PC (第 73 页) 而且从音乐发行服务购入的音乐文件可以很容易传送到录音机播放 (第 74 页)。记录在录音机的文件可以传送到 PC, 也可复制到 CD (第 75 页)。

窗口名称

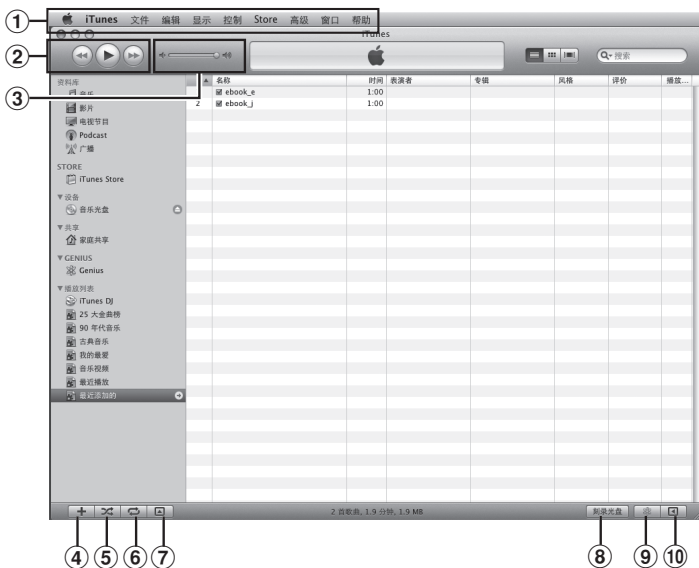

5

在 PC 上使用录音机

- ① 功能任务栏
- ② 后退按钮 / 播放、暂停按钮 / 快进按钮
- ③ 音量滑块
- ④ 播放清单新增按钮
- ⑤ 无序播放按钮

- ⑥ 重复按钮
- ⑦ 显示变更按钮
- ⑧ 刻录光盘按钮
- ⑨ Genius 按钮
- ⑩ Genius 侧按钮

复制 CD 上的音乐

1 插入 CD 到 CD-ROM 驱动，并启动 iTunes。

2 单击 [iTunes] → [偏好设置]。

3 单击 [通用] 标签。

4 单击 [导入设置] 设置复制到 PC 的文件格式和位率，并单击 [好]。

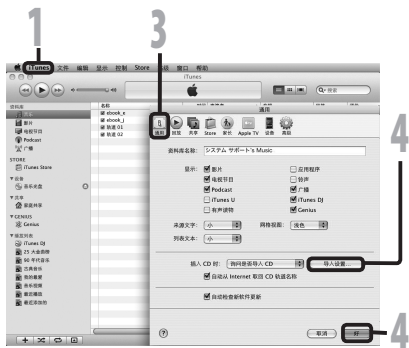

- 本录音机是同 MP3 和 WAV 格式音乐文件兼容的 (见第 33 页)。

【导入时使用】:

为从 CD 复制音乐文件设置文件格式。请选择 [MP3 编码器] 或 [WAV 编码器]。

【设置】:

为从 CD 复制音乐文件设置位率。可在 [128]、[160] 和 [192] 之间选择立体声位速率。

5 在希望复制的音乐文件上加上复选标记。

6 单击 [导入 CD]。



5

在 PC 上使用录音机

传送音乐文件至录音机

可以转移保存在 PC 的音乐文件到录音机。如何从 CD 复制音乐文件到 PC, 参阅“复制 CD 上的音乐”(第 73 页)。

1 连接录音机到 PC, 并启动 iTunes。

2 选择转移到录音机的播放列表, 并在希望转移的音乐文件上加上复选标记。

- 拖动播放列表中的音乐文件可改变音乐文件的顺序。

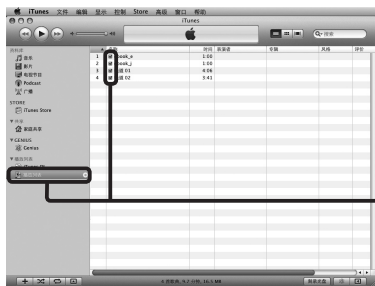

5

在 PC 上使用录音机

3 双击相应的录音机驱动, 并打开 [音乐] 文件夹。

- 将录音机同 Mac OS 相连时, 将被识别为桌面上的驱动名称 [LS_11]。插入 SD 卡时, 将被识别为驱动名称 [Untitled]。
- 转移音乐文件时复制到录音机的 [音乐] 文件夹。
- 最多可在 [音乐] 文件夹中创建 2 个层次结构。包括 [音乐] 文件夹在内可创建多达 128 个文件夹。
- 每个文件夹可保存多达 200 个文件。

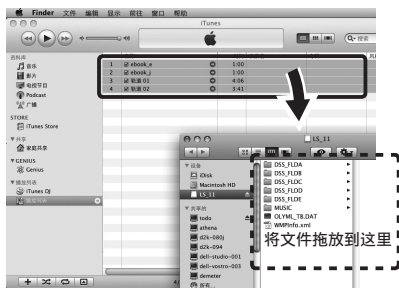

4 选择希望的文件, 并拖放到 [音乐] 文件夹。

复制声音文件至 CD

可以转移录音机的声音文件到 PC 和 CD。如何从录音机复制声音文件到 PC, 参阅“传输声音文件到个人电脑”(第 64 页)。

1 插入 CD-R/RW 到 CD-R/RW 驱动, 并启动 iTunes。

2 选择希望的播放列表, 并在要复制到 CD-R/RW 的声音文件上加上复选标记。

3 单击 [刻录光盘]。

4 为复制到 CD-R/RW 的声音文件设置 CD 格式, 并单击 [好]。

选择 [音频 CD] 时:

- 将文件转化或复制到音乐 CD 以便通过可以播放 CD-R/RW 的音频装置来播放。

选择 [MP3 CD] 时:

- 以 MP3 格式复制。

选择 [数据 CD] 时:

- 以要录音的格式复制文件。

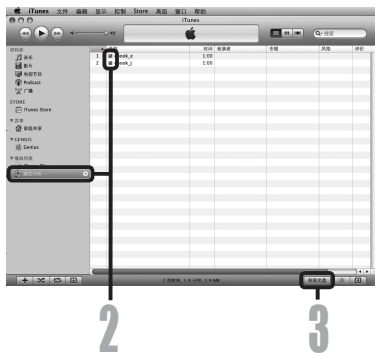

作为个人电脑的外部存储器使用

除用作 IC 录音机和音乐播放器外，该录音机还可以用作计算机的外部存储器，存储和读取计算机数据。

将录音机同 PC 相连，可以从 PC 下载和上传内存记忆数据。

备注

- 传输数据时，显示 [**Busy**]，且 [**PEAK**] 指示灯闪亮。当 [**PEAK**] 指示灯闪亮时千万不要断开 USB 连接。若断开数据将被破坏。

Windows

- 1 连接录音机到 PC (☞ 第 62 页)。
- 2 打开 Explorer (资源管理器) 窗口。
- 3 打开 [**LS_11**] 文件夹。
 - 打开 [**My Computer**] 时可以被识别为驱动名称 [**LS_11**] (内置闪存) 和 [**Removable Disk**] (SD 卡) (驱动器名会依所使用的电脑而定)。
- 4 复制数据。
- 5 断开 USB 连接线的连接 (☞ 第 63 页)。

Macintosh

- 1 连接录音机到 PC (☞ 第 62 页)。
 - 将录音机同 Mac OS 相连时，将被识别为桌面上的驱动名称 [**LS_11**]。当插入 SD 卡时，可被识别为驱动名称 [**Untitled**]。
- 2 双击桌面 [**LS_11**] 图标。
- 3 复制数据。
- 4 断开 USB 连接线的连接 (☞ 第 63 页)。

其他信息

警告信息列表

信息	意义	说明	解决方法
Battery Low	电池电量过低。	电池电量下降。	更换新电池 (☞ 第 11 页)。
File Protected	删除锁定。	尝试删除已锁定文件。	解除文件锁定 (☞ 第 41、47 页)。
Can't record in this folder	非音频记录文件夹。	尝试用 [Music] 文件夹记录。	从 [A] 到 [G] 选择一个文件夹, 并再次记录 (☞ 第 19 到第 21、23 页)。
Folder Full	文件夹已满	文件夹已装满文件 (最多 200 个文件)。	删除不需要的文件 (☞ 第 38 页)。
Memory Error	内存出错。	内存出错。	这是故障, 因此请到录音机购买店或奥林巴斯服务站修理。
		不能正确识别 SD 卡。	取出 SD 卡后再重新放入 (☞ 第 17 页到第 18 页)。
Licence Mismatch	非法复制文件。	非法复制的音乐文件。	删除文件 (☞ 第 38 页)。
Memory Full	剩余内存为零。	没有剩余内存。	删除不需要的文件 (☞ 第 38 页)。
No File	没有文件。	文件夹中没有发现文件。	选择其他文件夹 (☞ 第 19 到 21 页)。
SD Card Locked	卡被锁定。	SD 卡设置了写保护。	解除 SD 卡的写保护设置然后再试 (☞ 第 18 页)。
Format Error	格式化错误。	格式化录音机存储器时出错。	重新格式化存储器 (☞ 第 51 页)。
Can't make the system file. Connect to PC and delete unnecessary file	不能创建管理文件。	因为剩余内存容量不足, 不能创建管理文件。	连接录音机到计算机, 并删除不必要的文件。
Data Write Error	数据不能正确写入存储器。	数据不能及时写入存储器, 记录声音断续。	格式化存储器 (☞ 第 51 页)。

故障排除

症状	可能原因	解决方法
显示屏幕上无画面	电池没有正确安装。	确认正负极 ⊕ 和 ⊖ 是否正确 (☞ 第 11 页)。
	电池电量下降。	更换新电池 (☞ 第 11 页)。
	电源已经关闭。	打开电源 (☞ 第 13 页)。
不能启动	电池电量下降。	更换新电池 (☞ 第 11 页)。
	电源已经关闭。	打开电源 (☞ 第 13 页)。
	录音机处于锁定 (HOLD) 模式。	解除录音机的锁定 (HOLD) (☞ 第 13 页)。
不能录音	剩余内存太低。	删除不需要的文件 (☞ 第 38 页)。
	文件数量已经达到最大。	变换到另外的文件夹。(☞ 第 19 至 21 页、第 23 页)。
	SD 卡设置了写保护。	解除 SD 卡的写保护设置然后再试 (☞ 第 18 页)。
内置麦克风收不到声音	连接了外部麦克风或外部设备。	按下所有连接在 LINE IN 插孔和 MIC 插孔的外部麦克风和外部设备 (☞ 第 30、31 页)。
不能通过外部设备记录	有外部设备连接在 LINE IN 插孔上。	从录音机拔下连接线。
	连接了支持插入式电源的一个外部设备, 但 [Plug-in Power] 被设置为 [Off]。	连接支持插入式电源的外部麦克风时, 设置 [Plug-in Power] 为 [On] (☞ 第 41、44 页)。
无播放音	已连接耳机。	按下耳机使用内置扬声器。
	音量设置为 [0]。	调节音量 (☞ 第 32 页)。
录音音量过低	没有调节录音电平。	调节录音电平然后尝试再次录音 (☞ 第 26 页)。
	麦克风灵敏度太低。	设置麦克风灵敏度为 [HIGH] 模式然后再试 (☞ 第 27 页)。
	可能是录音电平和连接外部设备的输出电平太低。	如果调节录音电平后依然不能清晰录音, 调节连接设备的输出电平。(☞ 第 23 页)。
录音音量过高	没有调节录音电平。	调节录音电平然后尝试再次录音 (☞ 第 23 页)。
	可能是录音电平和连接外部设备的输出电平太高。	如果调节录音电平后依然不能清晰录音, 调节连接设备的输出电平。(☞ 第 23 页)。

症状	可能原因	解决方法
声音文件未记录为立体声	连接的外部麦克风是单声道。	录音时，若已连接外部单声道麦克风，则声音将只能录在 L 声道。
找不到记录的声音文件	记录媒体或文件夹错误。	切换至正确的记录媒体或文件夹 (☞ 第 19 至第 20 页、第 23 页、第 41 页、第 46 页)。
播放时有噪音	录音机在录音时有震动。	-----
	录音机在录音或播放时置于手机或荧光灯附近。	移动录音机。
	连接的外部麦克风的设定与录音机的设定不对应。	当连接的麦克风不支持外插式电源功能时，将 [Plug-inPower] 设定改为 [Off] (☞ 第 41 页、第 44 页)。
不能删除	文件被锁定。	解除文件锁定 (☞ 第 41、47 页)。
	文件为只读。	在 PC 上取消文件的只读设定。
从录音监听器听不到耳机声音	[Rec Monitor] 被设定为 [Off] 。	将 [Rec Monitor] 设定更改为 [On] (☞ 第 41、44 页)。
从录音监听器可听得到杂音	发声声回授。	若连接内置扬声器扩音器等设备，录音时将产生声回授的风险。建议使用耳机进行录音监听，或者在录音时将 [Rec Monitor] 设为 [Off] (☞ 第 41、44 页)。
		做些调整，例如使耳机远离麦克风、不要让麦克风对着耳机、降低录音监听器的音量等。

规格

一般规格

■ 记录格式：

线性 PCM (脉冲代码调制)
MP3 (MPEG-1/MPEG-2 音频第 3 层)
WMA (Windows Media Audio)

■ 输入电平：

麦克风灵敏度高/低开关设定为 [HIGH] 时：
— 59 dBv
麦克风灵敏度高/低开关设定为 [LOW] 时：
— 39 dBv

LINE IN 插孔输入：

— 6 dBv

■ 最大耳机输出：

6.7 mW + 6.7 mW (负荷 16 Ω)
 \leq 150 mV (依照 EN 50332-2)

■ 记录媒体：

内置 NAND FLASH 存储器 (8 GB)
SD 卡 (512 MB 至 32 GB)

■ 扬声器：

内置 \varnothing 16 mm 圆形动态扬声器

■ MIC 插孔：

\varnothing 3.5 mm 微型插孔, 电阻 2 k Ω

■ LINE IN 插孔：

\varnothing 3.5 mm 微型插孔, 电阻 78 k Ω (大约)

■ EAR 插孔：

\varnothing 3.5 mm 微型插孔, 电阻 8 Ω 以上

■ 最大输出功率：

200 mW + 200 mW (8 Ω 扬声器)

■ 输入电源要求：

电池：两节 AA 电池 (LR6) 或两节 Ni-MH 充电电池

外接电源：交流转接器 5 V

■ 外形尺寸：

131.5 mm \times 48 mm \times 22.4 mm
(不包括突出部分)

■ 重量：

165 g (包括碱性电池)

总频率响应：

■ LINE IN 插孔 (在录音或播放模式期间)：

线性 PCM 格式

记录模式	总频率响应
96 kHz	20 Hz 到 44 kHz
88.2 kHz	20 Hz 到 42 kHz
48 kHz	20 Hz 到 23 kHz
44.1 kHz	20 Hz 到 21 kHz
44.1 kHz / 单声道	20 Hz 到 21 kHz

MP3 格式

记录模式	总频率响应
320 kbps	50 Hz 到 20 kHz
256 kbps	50 Hz 到 20 kHz
128 kbps	50 Hz 到 17 kHz
单声道	50 Hz 到 13 kHz

WMA 格式

记录模式	总频率响应
160 kbps	50 Hz 到 19 kHz
128 kbps	50 Hz 到 19 kHz
64 kbps	50 Hz 到 15 kHz
单声道	50 Hz 到 13 kHz

■ 内置立体声麦克风 (录音模式期间)：

60 Hz 到 20 kHz

- 但是, 使用 MP3 格式或 WMA 格式录音时, 频率响应的上限值取决于各录音模式 (请参阅上面图表)。

录音时间指南

■ 线性 PCM 格式

记录模式	内置闪存 (8 GB)	SD 卡						
		512 MB	1 GB	2 GB	4 GB	8 GB	16 GB	32 GB
96 kHz 24 bit	3 小时 50 分	10 分钟	25 分钟	55 分钟	1 小时 50 分	3 小时 45 分	7 小时 30 分	15 小时 25 分
96 kHz 16 bit	5 小时 50 分	20 分钟	40 分钟	1 小时 20 分	2 小时 50 分	5 小时 45 分	11 小时 30 分	23 小时 10 分
88.2 kHz 24 bit	4 小时 10 分	15 分钟	30 分钟	1 小时	2 小时	4 小时 10 分	8 小时 15 分	16 小时 45 分
88.2 kHz 16 bit	6 小时 20 分	20 分钟	45 分钟	1 小时 30 分	3 小时 5 分	6 小时 15 分	12 小时 30 分	25 小时 15 分
48 kHz 24 bit	7 小时 45 分	25 分钟	55 分钟	1 小时 50 分	3 小时 50 分	7 小时 40 分	15 小时	31 小时
48 kHz 16 bit	11 小时 45 分	40 分钟	1 小时 25 分	2 小时 50 分	5 小时 45 分	11 小时 30 分	23 小时	46 小时 30 分
44.1 kHz 24 bit	8 小时 30 分	30 分钟	1 小时	2 小时	4 小时 10 分	8 小时 20 分	16 小时 30 分	33 小时 45 分
44.1 kHz 16 bit	12 小时 45 分	45 分钟	1 小时 30 分	3 小时 5 分	6 小时 15 分	12 小时 35 分	25 小时	50 小时 40 分
44.1 kHz / 单声道	25 小时 40 分	1 小时 25 分	3 小时	4 小时 50 分	12 小时 10 分	24 小时 55 分	50 小时 50 分	101 小时

■ MP3 格式：

记录模式	内置闪存 (8 GB)	SD 卡						
		512 MB	1 GB	2 GB	4 GB	8 GB	16 GB	32 GB
320 kbps	56 小时 50 分	3 小时 30 分	7 小时	13 小时 50 分	28 小时	55 小时 40 分	110 小时	224 小时
256 kbps	71 小时 05 分	4 小时 20 分	8 小时 50 分	17 小时 20 分	35 小时	69 小时 40 分	137 小时	280 小时
128 kbps	142 小时	8 小时 50 分	17 小时 40 分	34 小时 50 分	70 小时 10 分	139 小时	275 小时	560 小时
单声道	284 小时	17 小时	34 小时 10 分	54 小时 50 分	136 小时	276 小时	562 小时	1120 小时

■ WMA 格式：

记录模式	内置闪存 (8 GB)	SD 卡						
		512 MB	1 GB	2 GB	4 GB	8 GB	16 GB	32 GB
160 kbps	111 小时	6 小时 50 分	13 小时 50 分	27 小时 10 分	54 小时 50 分	109 小时	215 小时	438 小时
128 kbps	139 小时	8 小时 30 分	17 小时 20 分	34 小时	68 小时 40 分	136 小时	269 小时	547 小时
64 kbps	278 小时	17 小时 20 分	34 小时 50 分	68 小时 10 分	137 小时	272 小时	538 小时	1095 小时
单声道	556 小时	33 小时 20 分	66 小时 55 分	107 小时	266 小时	539 小时	1098 小时	2189 小时

备注

- 以上数值为近似值，仅供参考。
- 可记录的时间取决于卡的可用容量。
- 请注意，在取样频率和位率较低时，可记录时间的差异将增大。
- 如果实施了许多短时间记录，可记录时间将缩短（显示的可记录时间和记录的时间为大致显示值）。
- 单个文件的最大容量限制对 WMA 和 MP3 大约为 4GB，对线性 PCM 格式（WAV）大约为 2GB。
- 对于 WMA 和 MP3，单个文件的文件长度限于约 26 小时 40 分钟。因此，不同于单个文件的连续录音时间。

电池寿命指南

■ 碱性电池：

记录模式		内置立体声麦克风 (在录音模式期间)	内置立体声扬声器 (在播放模式期间)
线性 PCM 格式	96 kHz 24 bit	13 小时 30 分	29 小时
	44.1 kHz 16 bit	23 小时	52 小时

6

■ Ni-MH 充电电池

记录模式		内置立体声麦克风 (在录音模式期间)	内置立体声扬声器 (在播放模式期间)
线性 PCM 格式	96 kHz 24 bit	13 小时	24 小时
	44.1 kHz 16 bit	22 小时 30 分	42 小时

备注

- 以上数值为近似值，仅供参考。
- 电池寿命以本公司的测量方法为依据。根据使用的电池类型和使用条件会有显著不同。

规格与设计如有变更，恕不另行通知。

OLYMPUS

LINEAR PCM RECORDER
LS-11

Linear PCM Recorder

INSTRUCTIONS

EN

Thank you for purchasing an Olympus Digital Voice Recorder. Please read these instructions for information about using the product correctly and safely. Keep the instructions handy for future reference. To ensure successful recordings, we recommend that you test the record function and volume before use.

Introduction

- The contents of this document may be changed in the future without advanced notice. Contact our Customer Support Center for the latest information relating to product names and model numbers.
- The utmost care has been taken to ensure the integrity of the contents of this document. In the unlikely event that a questionable item, error, or omission is found, please contact our Customer Support Center.
- Any liability for passive damages or damage of any kind occurred due to data loss incurred by a defect of the product, repair performed by the third party other than Olympus or an Olympus authorized service station, or any other reason is excluded.

Trademarks and registered trademarks

- IBM and PC/AT are the trademarks or registered trademarks of International Business Machines Corporation.
- Microsoft, Windows and Windows Media are registered trademarks of Microsoft Corporation.
- Macintosh and iTunes are the trademarks of Apple Inc.
- The SD logo is a trademark.
- The SDHC logo is a trademark.
- MPEG Layer-3 audio coding technology licensed from Fraunhofer IIS and Thomson.
- EUPHONY MOBILE™ is a trademark of DiMAGIC Corporation.
- DVM™ is a trademark of DiMAGIC Corporation.

Other product and brand names mentioned herein may be the trademarks or registered trademarks of their respective owners.



EUPHONY
MOBILE



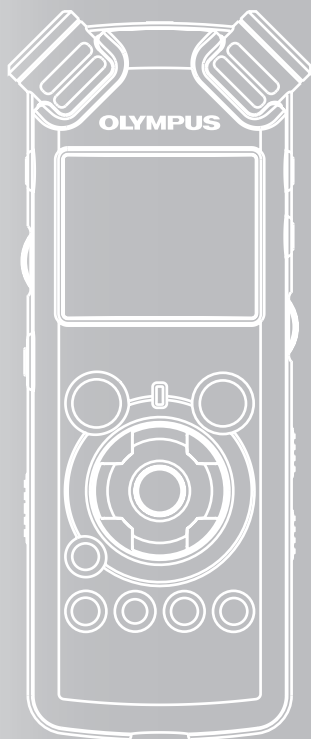

INDEX

Table of Contents	P.4
--------------------------	------------

Safe and Proper Usage	P.6
------------------------------	------------

Getting Started	P.8	1
------------------------	------------	----------

About Recording	P.22	2
------------------------	-------------	----------

About Playback	P.32	3
-----------------------	-------------	----------

Menu Setting	P.41	4
---------------------	-------------	----------

Using the Recorder on Your PC	P.61	5
--------------------------------------	-------------	----------

Other Information	P.77	6
--------------------------	-------------	----------

Table of Contents

Introduction

Table of Contents.....	4
Safe and Proper Usage	6

1 Getting Started

Main Features	8
Identification of Parts	9
Display (LCD Panel)	10
Inserting Batteries.....	11
Using the AC Adapter	12
Power Supply	13
HOLD	13
Setting Time and Date [Time & Date]	15
Changing the Time and Date.....	16
Inserting and Ejecting a Card	17
Inserting a Card	17
Ejecting a Card	18
Notes on the Folders.....	19
About the Folders for Voice Recordings	19
About the Folder for Music Playback	20
Selecting the Folders and Files	21

2 About Recording

Before Recording.....	22
Turn the Microphone Toward the Original Sound Source.....	22
Recording	23
Listening While Audio is Recorded	27
Set the Low Cut Filter	27
Microphone Sensitivity	27
Adjusting the voice sync level for recording	28
Recording from External Microphone or Other Devices	30

3 About Playback

Playback.....	32
Playback Through Earphone	35
Setting an index mark or a temp mark	35
How to begin segment repeat playback	36
Erasing	38
Erasing One File at a Time.....	38
Erase All Files from a Folder	38
Partially erase a file	39

4 Menu Setting

Menu Setting Method	41
Formatting the Recorder [Format].....	51
Rearranging files [Replace]	54
Moving Files [File Move]	56
Splitting Files [File Divide]	59

5 Using the Recorder on Your PC

Operating Environment.....	61
Connecting to Your PC.....	62
Connecting to Your PC	62
Disconnecting from Your PC	63
Transfer the Voice Files to Your PC.....	64
Using Windows Media Player.....	65
Window Names.....	65
Copying Music from CD.....	66
Transferring Music File to the Recorder.....	67
Copying Voice File to the CD	70
Using iTunes.....	72
Window Names.....	72
Copying Music from CD.....	73
Transferring Music File to the Recorder.....	74
Copying Voice File to the CD	75
Using as External Memory of the PC	76

6 Other Information

Alarm Message List.....	77
Troubleshooting.....	78
Technical Assistance and Support	80
Accessories (optional)	81
Specifications	82

Safe and Proper Usage

Before using your new recorder, read this manual carefully to ensure that you know how to operate it safely and correctly. Keep this manual in an easily accessible location for future reference.

- The warning symbols indicate important safety related information. To protect yourself and others from personal injury or damage to property, it is essential that you always read the warnings and information provided.

General Precautions

- **Do not leave the recorder in hot, humid locations such as inside a closed automobile under direct sunlight or on the beach in the summer.**
- **Do not store the recorder in places exposed to excessive moisture or dust.**
- **Do not use organic solvents such as alcohol and lacquer thinner to clean the unit.**
- **Do not place the recorder on top of or near electric appliances such as TVs or refrigerators.**
- **Avoid recording or playing back near cellular phones or other wireless equipment, as they may cause interference and noise. If you experience noise, move to another place, or move the recorder further away from such equipment.**
- **Avoid sand or dirt. These can cause irreparable damage.**
- **Avoid strong vibrations or shocks.**

- **Do not disassemble, repair or modify the unit yourself.**
- **Do not operate the unit while operating a vehicle (such as a bicycle, motorcycle, or go-cart).**
- **Keep the unit out of the reach of children.**
- **When mounting the recorder to a tripod, turn the screws on the tripod side without turning the recorder itself.**

<Warning regarding data loss>

Recorded content in memory may be destroyed or erased by operating mistakes, unit malfunction, or during repair work.

It is recommended to back up and save important content to other media such as a computer hard disk.

Any liability for passive damages or damage of any kind occurred due to data loss incurred by a defect of the product, repair performed by the third party other than Olympus or an Olympus authorized service station, or any other reasons is excluded from the Olympus's liability.

Batteries

Warning

- **Batteries should never be exposed to flame, heated, short-circuited or disassembled.**
- **Do not attempt to recharge alkaline, lithium or any other non-rechargeable batteries.**
- **Never use any battery with a torn or cracked outer cover.**
- **Keep batteries out of the reach of children.**
- **If you notice anything unusual when using this product such as abnormal noise, heat, smoke, or a burning odor:**
 - ① remove the batteries immediately while being careful not to burn yourself, and;
 - ② call your dealer or local Olympus representative for service.

AC Adapter

Warning

- **Do not attempt to disassemble, repair or modify the AC adapter in any way.**
- **Keep foreign objects including water, metal, or flammable substances from getting inside the product.**
- **Do not moisten the AC adapter or touch it with a wet hand.**
- **Do not use the AC adapter in the vicinity of flammable gas (including gasoline, benzine and lacquer thinner).**

In case

- **... the internal parts of the AC adapter are exposed because it has been dropped or otherwise damaged:**
- **... the AC adapter is dropped in water, or if water, metal flammable substances or other foreign objects get inside it:**
- **... you notice anything unusual when using the AC adapter such as abnormal noise, heat, smoke, or a burning odour:**
 - ① do not touch any of the exposed parts;
 - ② immediately disconnect the power supply plug from the power outlet, and;
 - ③ call your dealer or local Olympus representative for servicing. Continued use of the AC adapter under these circumstances could result in electric shock, fire or injury.

Getting Started

Main Features

1

Getting Started

- **Utilizes a high sensitivity, low noise stereo microphone capable of faithfully capturing the original sound.**

Machined metal components are utilized in the housing for the built-in stereo microphone, resulting in a design built with special features in mind while also achieving a construction which is resistant to vibration. Furthermore, by turning the microphone itself 90° outwards you can produce recordings with a natural and expansive stereo feel to them.

- **Equipped with a high sound quality amplifier circuit.**

Utilizes a low noise amplifier circuit, allowing you to produce high sound quality recordings with low noise.

- **Supports the linear PCM format, which is capable of recording sound quality equivalent to or surpassing CD-level.**

Capable of realistically recording various different sound sources. High resolution recording at a high sampling frequency and bit count equivalent or superior to that of a music CD (Sampling frequency 44.1 kHz, Bit count 16bit) is possible (✎ P.41, P.43).

- **Supports a wide range of recording formats. Can handle the MP3 format (MPEG-1/ MPEG-2 Audio Layer 3), and the Windows Media Audio (WMA) format.**

In supporting the MP3 and WMA formats, this device can save files in a highly compressed manner, thereby allowing for extended recording times (✎ P.41, P.43). In addition, when connected to an external device, the recorder can encode incoming analog audio signals without a PC (✎ P.30).

- **Supports high capacity recording media. Starting with its 8 GB built-in flash memory, can also record onto an SD Card (commercially available) (✎ P.17)..**

Check the Olympus website regarding SD cards which are confirmed operation with this recorder.

- **Equipped with a variety of features that support audio recording.**

With this recorder you can customize a variety of recording functions such as the recording level and microphone sensitivity to suit the recording conditions and personal preferences (✎ P.41, P.44).

- **Allows for system upgrades through enhanced options and equipment. Further enhances the pleasure of recording.**

- **Can playback WAV, WMA, and MP3 format files sent from a computer in addition to files recorded by the device itself. Can be enjoyed as a music player at any time.** Can hold approximately 2000 music files (WMA 128 kbps/ 4 minutes per song conversion) (✎ P.32, P.33, P.65, P.72).

- **Supports USB 2.0. Hi-Speed, which enables high-speed data transmission as an external memory device for your computer.**

By connecting the computer with the USB, pictures, text data, etc. can be saved, and utilized to carry data (✎ P.64, P.76).

- **You can move or copy files between the built-in memory and SD card, and within the folders in the memory (✎ P. 56).**
- **You can split files (✎ P. 59), or delete a part of a file (✎ P. 39) recorded in PCM format in this recorder.**

Identification of Parts

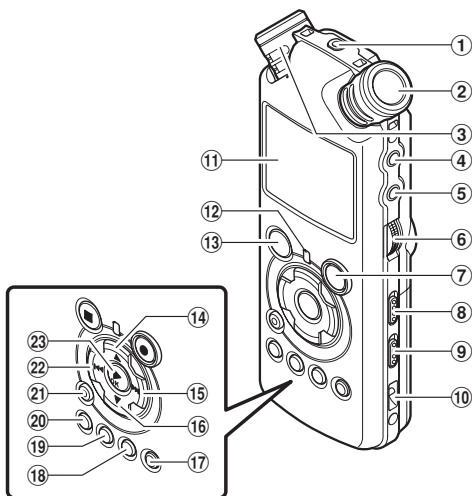

① REMOTE jack

Connect the receiver for the exclusive remote control set RS30W (optional). This enables operation of the main unit's record and stop functions through the remote control.

② Built-in stereo microphone (R)

③ Built-in stereo microphone (L)

④ LINE IN jack

⑤ MIC jack

⑥ REC LEVEL dial

⑦ REC ● button

Recording indicator light (LED)

⑧ MIC SENSE HIGH/LOW switch

⑨ LOW CUT ON/OFF switch

⑩ Strap hole

⑪ Display (LCD panel)

⑫ PEAK indicator light (LED)

⑬ STOP ■ button

⑭ ▲ button

⑮ ►► button

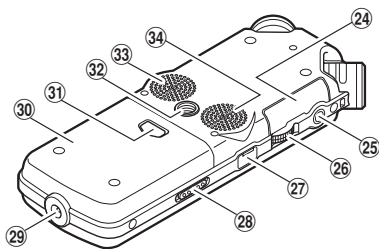

⑯ ▼ button

⑰ LIST button

⑱ MENU button

⑲ A-B REPEAT button

⑳ Fn button

㉑ ERASE button

㉒ ◀ button

㉓ ▶ /OK button

㉔ Card cover

㉕ EAR jack

㉖ VOLUME dial

㉗ USB terminal

㉘ POWER/HOLD switch

㉙ Power jack

㉚ Battery cover

㉛ Battery cover release button

㉜ Tripod socket

㉝ Built-in stereo speaker (R)

㉞ Built-in stereo speaker (L)

Display (LCD Panel)

Folder List Display

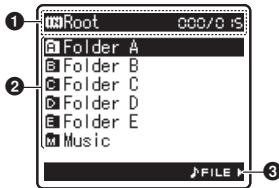

1 Root folder indicator

Folder indicator

Recording media indicator or folder indicator/
Root folder name/ Current file number/ Total
number of recorded files in the folder

2 Folder name

3 Guide indicator

File List Display

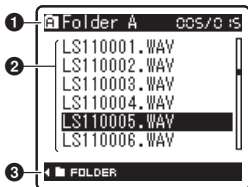

1 Folder/ File indicator

Folder name/ Current file number/ Total number
of recorded files in the folder

2 File name

3 Guide indicator

File Display

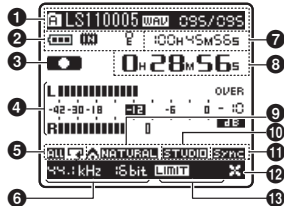

1 Folder/ File indicator

Folder name/ File name/ File format/ Current
file number/ Total number of recorded files in
the folder

2 Battery indicator

Recording media indicator

[**FM**] Built-in flash memory

[**SD**] SD card

Erase lock indicator

3 Record/ Playback status indicator

4 Level meter

5 Playback Mode indicator

6 Recording mode indicator

7 During recording mode:

Remaining recording time

During playback or stop mode:

File length

8 During recording mode:

Elapsed recording time

During playback mode:

Elapsed playback time

9 [EUPHONY] indicator

10 [Reverb] indicator

11 [V-Sync. Rec] indicator

12 [LowCutFilter] indicator

13 [Limiter] indicator

[Zoom Mic] indicator

Inserting Batteries

- 1 Press the battery cover release button, and then slide the battery cover open while lightly pressing down on it.

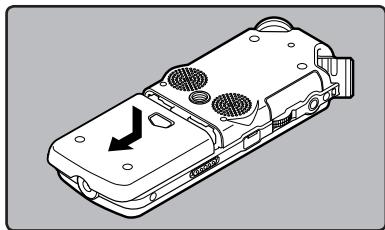

- 2 Insert two AA batteries with the correct ⊕ and ⊖ polarities.

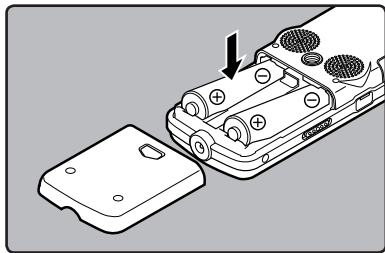

- 3 Close the battery cover completely by pressing to the direction (A), then sliding to the direction (B).

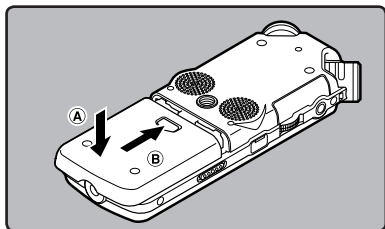

- 4 Slide the **POWER/HOLD** switch in the direction indicated by the arrow, and turn the power on.

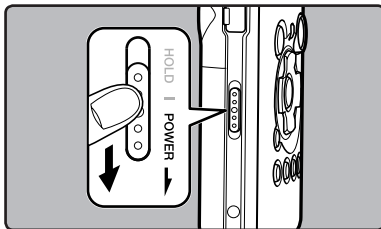

- If the “hour” indicator flashes in the display, see “**Setting Time and Date [Time & Date]**” (P.15).

Replacing batteries

The battery indicator on the display changes as the batteries lose power.



- When [] appears on the display, replace the batteries as soon as possible. When the battery is too weak, [] and **Battery Low** appears on the display and the recorder shuts down.

Ni-MH Rechargeable Battery

Ni-MH rechargeable batteries B-01 4PE (optional) from Olympus can be used in the recorder. Use them with the Olympus Ni-MH Rechargeable Battery Charger B-90SU (optional) (For U.S.A. and Canada) or BU-90SE (optional) (For Europe).

Notes

- This recorder cannot charge rechargeable batteries.
- Manganese battery may not be used in this recorder.
- When changing batteries, AA alkaline batteries or Olympus Ni-MH Rechargeable Batteries are recommended.
- Be sure to turn off power of the recorder before replacing the batteries (☞ P.13). Unloading the batteries while the recorder is in use may cause a malfunction such as corrupting the file, etc. If you are recording into a file and the batteries run out, you will lose your currently recorded file because the file header will not be able to close. It is crucial to change the batteries once you see only one Hash mark in the battery indicator.
- If it takes longer than 15 minutes to replace the dead battery or if you take the battery in and out repeatedly at short intervals, you may have to reset the time when you have loaded a fresh battery (☞ P.15).
- Remove the batteries if you are not going to use the recorder for an extended period of time.
- When playing a voice/music file, the recorder may be reset due to the reduction of the voltage output of the battery depending on the volume level even if [] is displayed in the battery indicator. In this case, lower the volume of the recorder.

Using the AC Adapter

Plug the AC adapter (optional) into a household power outlet and connect the power plug to the recorder's power connector (DC 5V). Always turn the recorder's power off before connecting.

If the AC adapter is plugged in while recording using batteries, it may not be possible to play back the voice data being recorded.

- Check the Olympus website regarding AC adapters which can be used with this recorder.

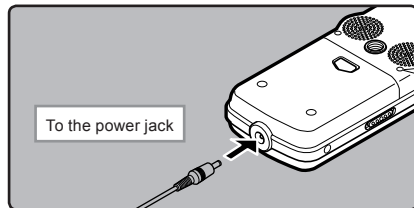

⚠ Warning

- **Always turn the recorder's power off before connection or disconnection.**
- **When the AC adapter is not in use, disconnect the power supply plug from the power outlet.**
- **Use only the correct power supply voltage as indicated on the adapter.**
- **Do not use the AC adapter when connecting the recorder to the USB port.**

Power Supply

When the recorder is not being used, turn the power off to reduce battery consumption to a minimum. Even if the power is turned off, existing data, mode settings, and clock settings will be maintained.

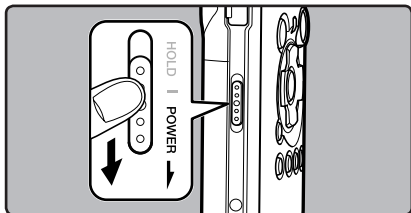

Turning On the Power:

While the recorder's power is off, slide the **POWER/HOLD** switch in the direction indicated by the arrow.

- The display will turn on, and the power will be turned on.
- The resume function will bring the recorder back to the stop position in memory before power was turned off.
- When the batteries are removed from the recorder the resume function's stopped position will be erased.

Turning Off the Power:

Slide the **POWER/HOLD** switch in the direction indicated by the arrow for **1 second or longer**.

- The display shuts off and the power will be turned off.
- The resume function remembers the stop position before the power is turned off.

Power save mode [AutoPowerOff]

If the recorder is stopped/not used for over 10 minutes (initial setting) while the power is turned on, the power will be turned off (☞ P.41, P.47).

- If any button is pressed prior to the battery turning off, the elapsed time count will start over again until this function takes effect.

HOLD

If you bring the recorder is set to HOLD mode, the current conditions will be preserved, and all buttons will be disabled. This feature is useful when the recorder has to be carried in a bag or pocket.

Set the recorder to HOLD mode

Slide the **POWER/HOLD** switch to the **[HOLD]** position.

- After **[Hold]** appears on the display, the recorder is set to HOLD mode.

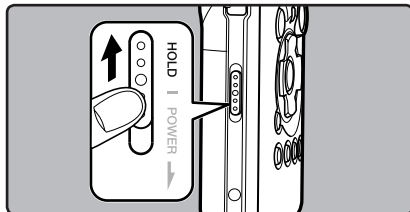

Exit HOLD mode

Slide the **POWER/HOLD** switch to the **(A)** position.

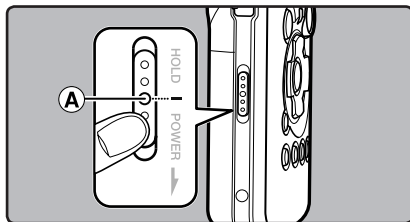

Notes

- If you press any button in HOLD mode, the clock display flashes for 2 seconds, but it will not operate the recorder.
- If HOLD is applied during playback (recording), operation is disabled with the playback (recording) state unchanged (When playback has ended and the recording has ended due to the remaining memory being used up, it will stop).
- The recorder can be effectively operated via its switch and dial, as well as the connected exclusive remote control set RS30W (optional), even when it is in HOLD mode.

Setting Time and Date [Time & Date]

If you set the time and date beforehand, the information when the file is recorded is automatically stored for each file. Setting the time and date beforehand enables easier file management.

When you use the recorder for the first time after purchasing it, or when the batteries have been inserted without the device having been used in a long time, the [Set Time & Date] will appear. When the "hour" is flashing, conduct the setup from Step 1.

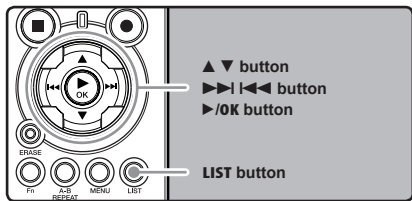

1 Press the ▶▶ or ◀◀ button to select the item to set.

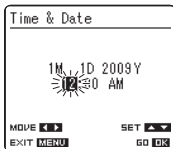

Select the item from the "hour", "minute", "year", "month" and "day" with a flashing point

2 Press the ▲ or ▼ button to set.

- Follow the same steps by pressing the ▶▶ or ◀◀ button to select the next item, and press the ▲ or ▼ button to set.
- You can select between 12 and 24 hour display by pressing the LIST button while setting the hour and minute.

Example: 10:38 P.M

10:38 PM ↔ 22:38
(Initial setting)

- You can select the order of the "year", "month", "day" by pressing the LIST button while setting them.

Example: January 1, 2009

1M 1D 2009Y (Initial setting) ←
↓
1D 1M 2009Y
↓
2009Y 1M 1D

3 Press the ▶/OK button to complete the setting.

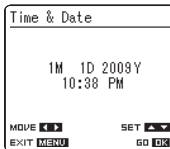

- The clock will start from the set date and time. Press the ▶/OK button according to the time signal.

Note

- If you press the ►/OK button during the setup operation, the recorder will save the items that were set to that point.

1

Getting Started

Changing the Time and Date

While the recorder is during stop mode, press and hold the **STOP** ■ button to display the Time and Date, Remaining Memory and File Format.

If the Time and Date is not correct, set it using the procedure below.

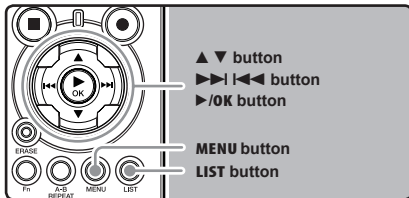

1 While the recorder is during stop mode, press the MENU button.

- The menu will appear on the display (☞ P.41).

2 Press the ▲ or ▼ button to select [Others] tab.

- You can change the menu display by moving the settings tab cursor.

3 Press the ►/OK or ►►| button to move the cursor to the item to set.



[Others] will appear on the display

4 Press the ▲ or ▼ button to select [Time & Date].

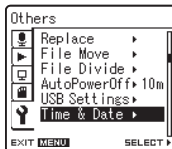

[Time & Date] will appear on the display

5 Press the ►/OK or ►►| button.

- The "hour" will flash on the display, indicating the start of the Time and Date setup process.

The following steps are the same as Step 1 through Step 3 of "Setting Time and Date [Time & Date]" (☞ P.15).

6 Press the MENU button to close the menu screen.

Inserting and Ejecting a Card

This recorder can be used with commercially available SD Cards as well as the built-in flash memory.

Inserting a Card

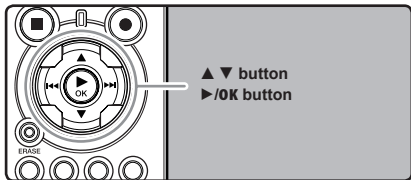

1 While the recorder is during stop mode, open the card cover.

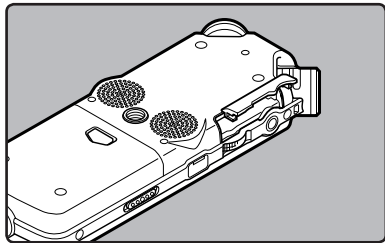

2 Face the card the correct way and insert it into the card slot as shown in the diagram.

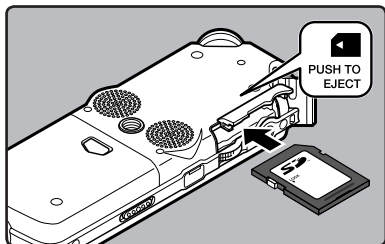

- Insert the card keeping it straight.
- The card stops with a click when it is inserted all the way.
- Inserting the card the wrong way or at an angle could damage the contact area or cause the card to jam.
- If the card is not inserted all the way, data may not be written to the card.

3 Close the card cover securely.

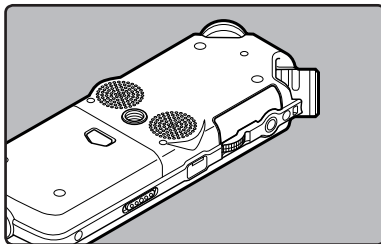

4 When you are recording to a card, press the ▲ or ▼ button and select [Yes].

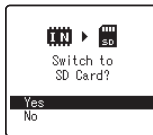

When you insert the card, the recording media changeover display will appear.

5 Press the ▶ /OK button to complete the setting.

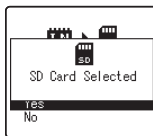

Notes

- It is possible to switch the recording media over to the built-in flash memory (☞ P.41, P.46).
- In some cases cards which have been formatted (initialized) by another device, such as a computer, cannot be recognized. Be sure to format them with this recorder before using (☞ P.51).
- When attempting to perform operations such as rewriting the contents of an SD Card in cases where the card has been write protected, **[SD Card Locked]** will appear. The playback operation can be performed, but the write protection must first be turned off when overwriting the contents on the card.
- Cards that are not to SD standards, such as multimedia cards, may not be used.

Ejecting a Card

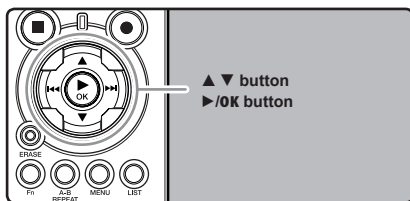

1 While the recorder is during stop mode, open the card cover.

2 Push the card inward to unlock it, and let it eject partially.

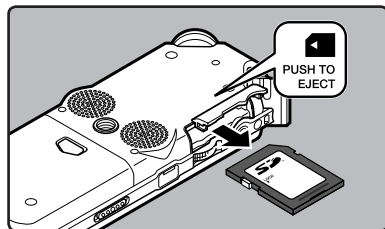

Inserting and Ejecting a Card

- The card is visibly out of the slot and can be removed safely.

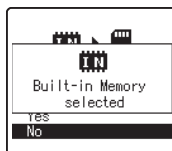

When **[MemorySelect]** is set to **[SD Card]**, **[Built-in Memory selected]** will appear

3 Close the card cover securely.

Note

- Releasing your finger quickly after pushing the card inward may cause it to eject forcefully out of the slot.

About the SD Card

When the SD Card is write protected, there will be a display reading **[SD Card Locked]**. Before inserting the card, turn off the write protection function. Check the Olympus website regarding SD cards which are confirmed operation with this recorder.

If the write protection switch is facing the **[LOCK]** direction, recording and other functions cannot be carried out



Notes

- The recorder may not recognize correctly on some SD cards. In this case, remove the card then put it again to see if the recorder recognizes the card.
- The processing performance reduces in a SD card when you repeat writing and delete. In this case, format the SD card (☞ P.51).

Notes on the Folders

The built-in flash memory or the SD Card can be used for the recording media. Regardless of the recording media, voice files and music files are separated into folders for voice recordings and folders for music playback that are organized in a branching tree-style and saved.

About the Folders for Voice Recordings

[Folder A] - [Folder E] are the folders for voice recordings. When recording with the recorder, select any one of the five folders and then record.

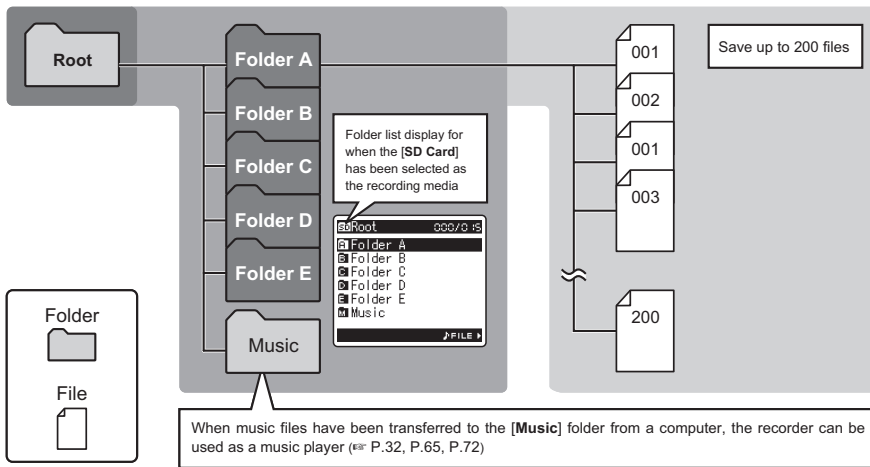

File names will be automatically created for files recorded by this recorder.

LS11 0001 .WAV

①

②

③

① **User ID:**

The name that has been set on the Digital Voice Recorder.

② **File number:**

A file number is consecutively assigned regardless of the changes in the recording media.

③ **Extension:**

These are the file name extensions for the recording format when recording with this device.

- Linear PCM format .WAV
- MP3 format .MP3
- WMA format .WMA

About the Folder for Music Playback

When transferring music files to the device using Windows Media Player, a folder is automatically created within the music playback folder which has a layered structure as shown in the diagram below. Music files that are in the same folder can be rearranged in preferential order and replayed (☞ P.54).

1

Getting Started

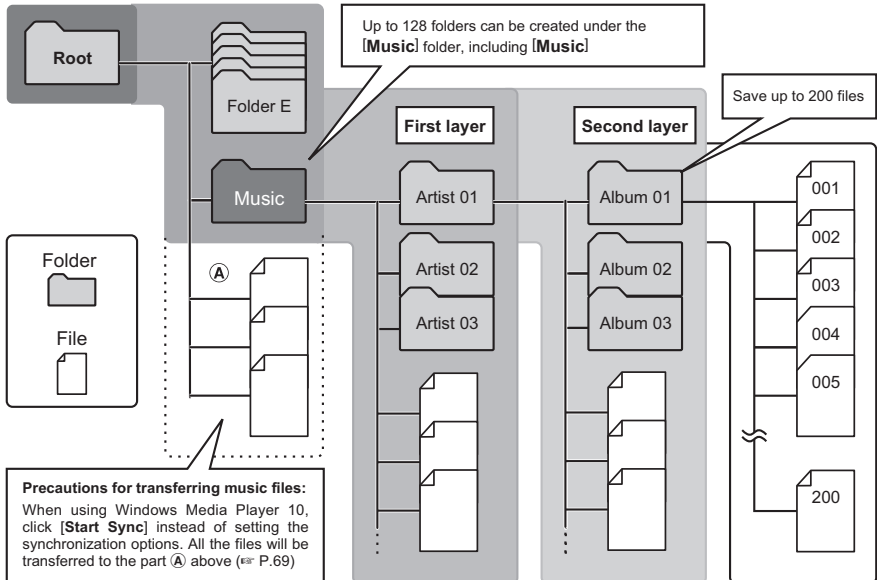

Selecting the Folders and Files

Change folders while the operation is stopped. For information on the layered structure of the folders, see the section entitled “Notes on the Folders” (P.19, P.20).

Operation of the folders for music playback

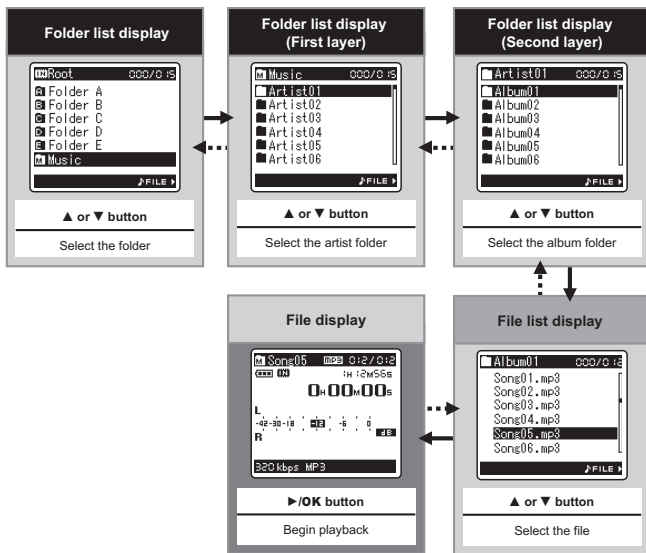

■ Moving through the levels

►/OK button

Proceed →

Each time you press this it opens the folder or file selected in the list display and proceeds down one level. The list display screen can be operated by the ►| button

LIST button

Return ←

Each time you press this it returns up one level. The list display can be operated by the ◀◀ button

List display

The folders and files recorded in this recorder are displayed

File display

Information of the selected file is displayed. Enters in playback standby mode

Operation of the folders for voice recordings

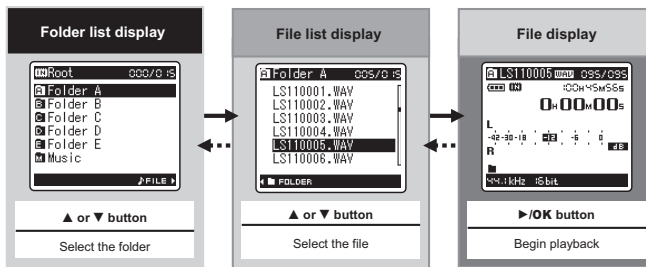

About Recording

Before Recording

2

About Recording

Getting Ready

Affix the windscreen:

Start recording after attach the windscreen (included within) to the microphone. The noise may occur even if a windscreen is attached when forcing wind blows against a microphone.

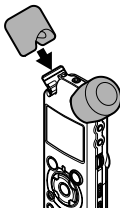
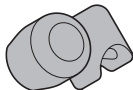

Select the media for recording:

The built-in flash memory as well as an SD Card can be used (☞ P.17, P.41, P.46).

Select the recording format:

Recording can be performed through the linear PCM format, as well as the WAV, MP3 and WMA formats (☞ P.41, P.43).

Turn the Microphone Toward the Original Sound Source

Turn the built-in stereo microphone in the direction that you would like to record. Placing the built-in stereo microphone over the display is the proper position for performing stereo recording. If it is below the display when recording then proper stereo recording cannot be performed because the position of the original sound will be recorded in reverse phase.

Original
sound
source

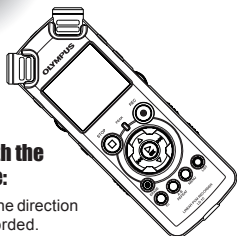

When recording with the built-in microphone:

Turn the microphone in the direction of the source to be recorded.

About the built-in stereo microphone:

The direction of capturing sound by the microphone can be changed with the **MIC SENSE HIGH/LOW** switch (☞ P.27).

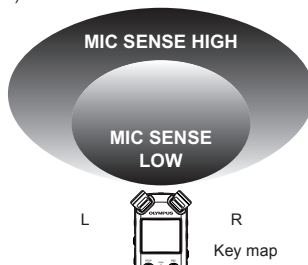

On mounting:

Accurate adjustments of the microphone's angle and the like can be made when the device is affixed to a commercially available tripod used for cameras.

Recording

Before starting recording, select a folder between [A] to [E]. These five folders can be selectively used to distinguish the kind of recording; for example, Folder [A] might be used to store private information, while Folder [E] might be dedicated to holding business information.

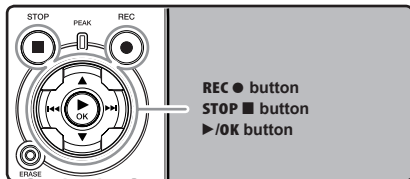

1 Select the recording folder (see P.19 to P.21).

How to change folders:

- Pressing the **LIST** button at the file display while stopped will return you back one layer above. Pressing the **LIST** button repeatedly will bring you to the folder list display.
- Pressing button **▲** or **▼** at the folder list display will select the folders for voice recordings.
 - Newly recorded audio will be saved as the last file in the selected folder.

2 Press the REC ● button and prepare to record.

- Turn the microphone in the direction of the source to be recorded.
- Remaining recording time
- Level meter (change according to the recording level and recording function settings)
- Recording mode

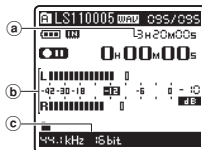

- The recording indicator light will flash and [●] will appear on the display.
- The voice sync level can be set when voice sync recording is on.
- [**Rec Mode**] cannot be changed in the recording standby mode or while recording. Configure this while the recorder is stopped (see P.41, P.43).
- The various functions related to recording can be configured to suit the recording conditions (see P.41, P.43, P.44).
- The level indicator position of the level meter will change in accordance with the switching of the various settings related to recording. Confirm the recording level through the level meter after switching the settings.

3 Use the REC LEVEL dial to adjust the recording level.

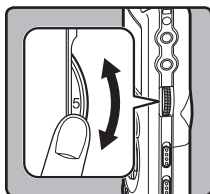

This can be adjusted in a range from [0] to [10]. The larger the number on the dial is the higher the recording level will be, and the indicator position of the level meter will grow larger as well.

- This recorder is designed to be able to record cleanly and evenly, even in recording conditions such as when the volume of the source sound changes significantly. However, even higher sound quality recordings can be achieved by adjusting the recording level manually.
- If too big sound is input, the noise may occur even if [**Rec Level**] is set to [**Auto**] or [**Limiter On**]. Also, in certain cases the [**PEAK**] indicator light, which notifies large input, may not light. To ensure successful recordings, we recommend that you test the record function and volume before use.
- When [**Rec Level**] is set to [**Auto**] the recording level will be adjusted automatically. Set [**Rec Level**] to [**Manual**] when using the recording level adjustment function and the limiter function (see P.41, P.43).

Actually producing the sound you would like to record:

- When a loud sound is produced the level meter will swing all the way over to the right while recording and the **[PEAK]** indicator light will turn on. When this happens the sound will be recorded in a distorted manner since the recording level is too high.

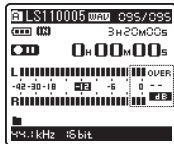

When the level meter is maxed out (the recorded sounds will be distorted)

- When a loud noise is produced, adjust the recording level so that the level meter remains in the vicinity of **[-6]**.

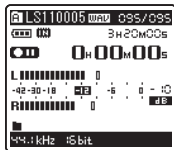

Example of conditions where the recording level has been lowered and the excess input has been adjusted

4 Press the REC ● button again will begin recording.

- [●]** will appear on the display.
- ⓓ Elapsed recording time

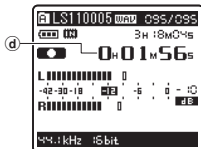

5 Press the STOP ■ button to stop recording.

- [■]** will go out on the display.
- ⓔ File length

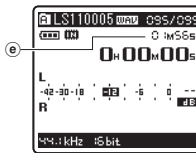

Notes

- The recording will continue even if the volume of a single file exceeds 2 GB in the linear PCM format recording (ⓔ P.43).
 - The file is saved every 2 GB in separate files. It will be treated as multiple files when playing back.
 - When the recording exceeds 2 GB, the number of files in the folder may exceed 200 files. The 201st file and later will not be recognized by the recorder, so check by connecting the recorder to a PC.
- When an SD Card is inserted in the recorder, be sure to confirm the recording media as either **[Built-in Memory]** or **[SD Card]** so that there is no mistake (ⓔ P.41, P.46).
- When attempting to perform operations such as rewriting the contents of an SD Card in cases where the card has been write protected, **[SD Card Locked]** will appear. The playback operation can be performed, but the write protection must first be turned off when overwriting the contents on the card (ⓔ P.18).
- If you select a folder other than **[A]** through **[E]** and press the **REC ●** button, an **[Can't record in this folder]** message will flash. Select a folder from **[A]** through **[E]** and start recording again.

- When remaining recording time is less than 60 seconds, the [PEAK] indicator light starts flashing in amber. When the recording time is decreasing to 30 or 10 seconds, the light flashes faster.
- **[Folder Full]** will appear when the folder capacity is full. Delete any unnecessary files before recording any further (P.38).
- **[Memory Full]** will appear when the memory is full. Change the recordable media or delete any unnecessary files before recording any further (P.38, P.41, P.46).
- When the recording button of the exclusive remote control RS30W (optional) is pressed once, recording will start immediately.
- Depending on the sound recording mode and the status of record media, the data transfer to the media cannot be done in time during recording and the skipped sound may be recorded. In this case, **[Data Write Error]** will appear during recording or when the recording is finished. After transferring the data to the PC, format the record media.
- We recommend the media to be formatted before recording.

Pause

While the recorder is during recording mode, press the REC ● button.

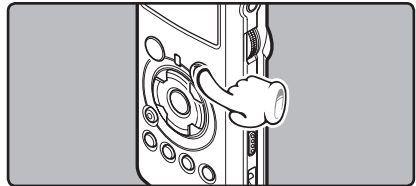

- [●] will appear on the display.
- The recorder will time out after 60 minutes when left in "Rec Pause".

Resume Recording:

Press the REC ● button again.

- Recording will resume at the point of interruption.

To quickly check on the recorded contents

While the recorder is during recording mode, press the ►/OK button.

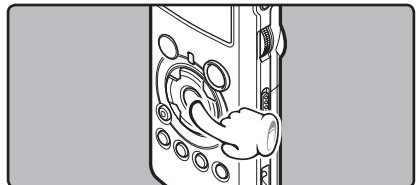

- [▶] will appear on the display.
- Stop recording and the file that was just recorded will be played back.

Recommended settings by recording condition

The recorder is set up so that it can perform high quality recording equivalent to that of a music CD right away. The various functions relating to recording can be configured in detail to suit the recording conditions.

Recording settings	Recording condition					
	Indoor musical performance	Band performance in a practice studio	Performance in a vast hall, etc.	Outdoor environment sounds like wild birds singing, railroad noises, etc.	Conferences with large crowds in vast meeting venues	Conferences with a few people indoors
Recording level* (☞ P.23)	When the [Rec Level] is set to [Manual] you can adjust the recording level. Adjust while looking at the level meter					
Microphone sensitivity (☞ P.27)	[LOW]			[HIGH]		
Low Cut Filter (☞ P.27)	[OFF]				[ON]	
[Rec Mode] (☞ P.41, P.43)	The recording level can be adjusted to suit the volume of the original sound					
[Rec Level] (☞ P.41, P.43)	You can configure whether to adjust the recording level automatically or to adjust it manually. When [Rec Level] is set to [Manual] you can configure the limiter function					
[Zoom Mic] (☞ P.41, P.43)	The directivity of the built-in stereo microphone can be set according to the source to be recorded					
[Rec Monitor] (☞ P.41, P.44)	Select whether or not to output the recording monitor sound from the EAR jack					
[Plug-inPower] (☞ P.41, P.44)	Select whether or not to use the plug-in power function according to the external microphone connected to the MIC jack					

* When [Rec Level] is set to [Auto] the recording level will be adjusted automatically. When this happens, the recording level adjustment function and limiter function will not work (☞ P.23, P.41, P.43).

Listening While Audio is Recorded

If you start recording after inserting the earphone into the **EAR** jack on the recorder, you can hear the sound being recorded. The recording monitor volume can be adjusted by using the **VOLUME** dial.

Connect the earphone to the **EAR** jack on the recorder.

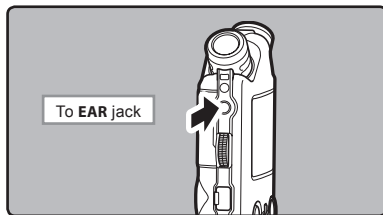

- After recording has started, you can hear the sound being recorded through the earphone. If the earphone is connected, no sound will come from the speaker.

Notes

- Recording level cannot be controlled using the volume button.
- When using the earphones, do NOT set the volume too high. Listening at very high volume may lead to hearing loss.
- Do not place earphones near a microphone as this may cause feedback.
- When the external speaker is connected while recording, there is a risk that audio feedback will occur. It is recommended that you use earphones for the recording monitor, or turn **[Rec Monitor]** to **[Off]** while recording (P.41, P.44).
- When **[Rec Monitor]** is set to **[Off]** no sound will come out of the earphones while you are recording (P.41, P.44).

Set the Low Cut Filter

The recorder has a Low Cut Filter function to minimize low-frequency sounds and record voices more clearly. This function can reduce noise from air conditioners, projectors and other similar noises.

Slide the **LOW CUT ON/OFF** switch and select **[ON]** or **[OFF]**.

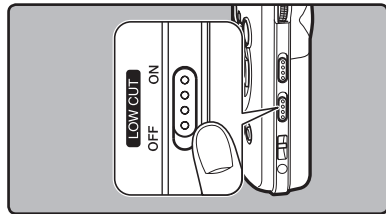

- [ON]:**
Enables the Low Cut Filter function.
- [OFF]:**
Disables this function.

Microphone Sensitivity

Microphone sensitivity is adjustable to meet recording needs.

Slide the **MIC SENSE HIGH/LOW** switch and select **[HIGH]** or **[LOW]**.

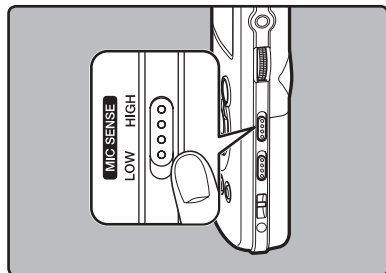

[HIGH]:

This is a highly sensitive mode which can record surrounding noises.

[LOW]:

This is the standard level of microphone sensitivity. Select this mode for cases where the volume of the source sound is high, such as a band performance.

Note

- When you would like to clearly record a speaker's voice, set the recorder to [LOW] and hold its built-in stereo microphone close to the speaker's mouth (5-10 cm) before recording.

2

About Recording

Adjusting the voice sync level for recording

Voice sync recording allows you to start recording when voice louder than the voice sync level (detection level) is detected, and automatically stop recording when the voice becomes quiet. When voice sync recording is on (see P.44) and the voice is below the voice sync level (detection level) for longer than the specified detection time, the recorder stops.

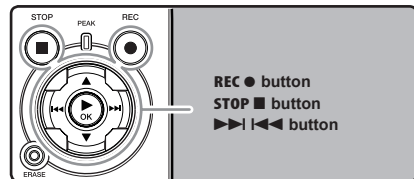

1 Select the recording folder (see P.19 to P.21).

How to change folders:

- ① Pressing the LIST button at the file display while stopped will return you back one layer above. Pressing the LIST button repeatedly will bring you to the folder list display.
 - ② Pressing button ▲ or ▼ at the folder list display will select the folders for voice recordings.
- Newly recorded audio will be saved as the last file in the selected folder.

2 Press the REC ● button and prepare to record.

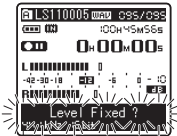

[Level Fixed?] will flash on the display.

- To use voice sync recording, set [V-Sync. Rec] on and set the detection time (see P.44).

3 Press the ►► or ◀◀ button to adjust the voice sync level.

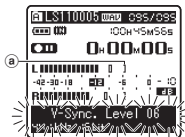

Appears the voice sync level in 23 steps ([01] to [38]) on the display.

- The higher the value, the more sensitive the recorder gets to sounds. At the highest value, even the faintest sound will activate recording.
- a** Voice sync level (moves to the right/left according to the set level)

4 Press the REC ● button again.

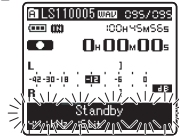

- Recording enters standby. [Standby] flashes on the display and the recording indicator light flashes. If input meets or exceeds the voice sync level, recording starts automatically. At this time, the recording indicator light glows.

5 Recording stops automatically.

- If the volume is equal to or less than voice sync level for longer than the specified time, recording stops automatically. At this time, the recording indicator light turns off.
- To manually stop recording, press **STOP** ■ button.

Recording from External Microphone or Other Devices

The external microphone and other devices can be connected and the sound can be recorded. Connect as follows by the device to be used.

- Do not plug and unplug devices into the recorder's jack while it is recording.

Recording with External Microphone:

Connect an external microphone to the MIC jack of the recorder.

- When recording while an external monaural microphone is connected, sound will only be recorded by the L-channel.

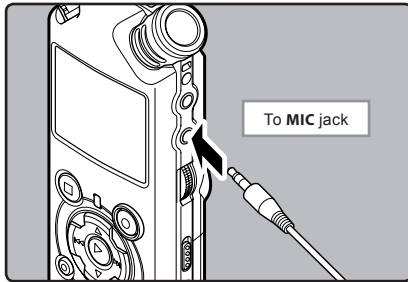

Applicable External Microphones (optional)

Stereo microphone: ME51S

The built-in large-diameter microphone enables sensitive stereo recording.

2 channel microphone (omni-directional): ME30W

These are highly sensitive omni-directional microphones supported by plug-in power which are well-suited to recording musical performances.

Highly sensitive noise-cancellation monaural microphone (unidirectional): ME52W

This microphone is used to record sound at a distance while minimizing surrounding noise.

Compact Gun Microphone (unidirectional): ME31

The directional microphones is useful for recordings such as outdoor recording of wild birds singing. The metal-cut body provides a sturdiness to the high rigidity.

Tie clip microphone (omni-directional): ME15

Small concealing microphone with a tie-clip.

Telephone pickup: TP7

Earphone type microphone can be plugged into your ear while phoning. The voice or conversation over the phone can be clearly recorded.

Notes

- The built-in microphone will become inoperable when an external microphone is plugged into the recorder's **MIC** jack.
- Microphones supported by plug-in power can also be used. When the plug-in power function is set to **[On]** power will be supplied by the device to the microphone (☞ P.41, P.44).
- Turn the plug-in power function to **[Off]** when an external microphone not supported by plug-in power is connected, as there is the risk that noise may be generated while recording (☞ P.41, P.44).
- Do not connect the connecting cord to the **LINE IN** jack when recording from external microphone with this recorder.

Recording the Sound of Other Devices with This Recorder:

The sound can be recorded when connecting to the audio output terminal (earphone jack) of the other device, and the **LINE IN** jack of the recorder with the connecting cord KA334 (included within) for dubbing.

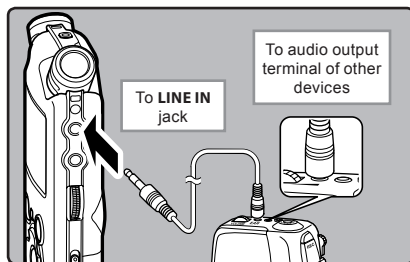

Notes

- If you are unable to produce a clear recording with this recorder even after adjusting the recording level (☞ P.23), this could potentially be because the output level for the connected devices is too high or too low. When external devices are connected, perform a test recording and then adjust the output level for the external devices.
- Do not connect the connecting cord to the **MIC** jack when recording sound from other device with this recorder.

Recording the Sound of This Recorder with Other Devices:

The sound of this recorder can be recorded to other devices when connected to the audio input terminal (line jack) of other devices and the **EAR** jack of this recorder, with the connecting cord KA334 (included within) for dubbing.

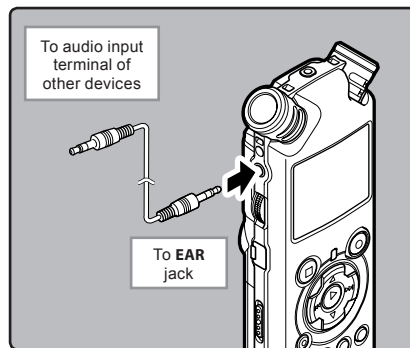

Notes

- When you adjust the various sound quality settings related to playback on the recorder, the audio output signal sent out from the **EAR** jack will change as well (☞ P.41, P.45).
- In case of recording on other devices without a line input, the input may be too large to control when the audio is input to the microphone jack. In this case, use the connecting cord KA333 (optional) with attenuation resistance.

About Playback

Playback

The recorder can playback WAV, MP3 and WMA format files. To playback a file recorded with other machines, you need to transfer (copy) it from a computer.

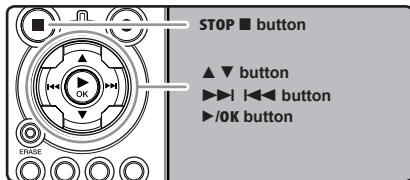

1 Select the folder which contains the files to be played back (refer P.19 to P.21).

How to change folders:

- Pressing the **LIST** button at the file display while stopped will return you back one layer above. Pressing the **LIST** button repeatedly will bring you to the folder list display.
- Pressing button **▲** or **▼** at the folder list display will select the folders for voice recordings and press the **▶▶|** button.

2 In the File list display, press the **▲** or **▼** button to select the file that you want to playback.

- In the File display, press the **▶▶|** or **|◀◀** button to select a file.

3 Press the **▶/OK** button to start playback.

- [▶]** will appear on the display.
- Folder name/ File name/ File format/ Current file number/ Total number of recorded files in the folder
- File length
- Elapsed playback time
- Level meter

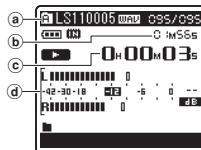

4 Use the **VOLUME** dial to adjust to a comfortable listening volume.

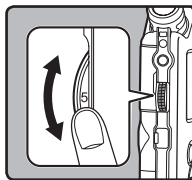

The volume can be adjusted within a range from [0] to [10]. The larger the number on the dial is the higher the volume will be

5 Press the **STOP** or **▶/OK** button at any point you want to stop the playback.

- [▶]** will go out on the display.
- This will stop the file being played back midway. When the resume function is activated the stopped location will be registered, even if the power is turned off. The next time the power is turned on, playback may be resumed from the registered stopped location.
- When the batteries are removed from the recorder the resume function's stopped position will be erased.

Settings relating to playback

Segment repeat (<small>ESP</small> P.36)	This allows you to repeatedly playback part of a file during playback.
[Play Mode] (<small>ESP</small> P.41, 45)	[File] [File Repeat] [Folder] [Folder Repeat] [All] [All Repeat]
[Reverb] (<small>ESP</small> P.41, 45)	[Normal] [Studio] [Club] [Hall] [Dome]
[EUPHONY] (<small>ESP</small> P.41, 45)	[Normal] [Natural] [Wide] [Power]
[Replace] (<small>ESP</small> P.54)	This changes the order of the files in the selected folder. It is useful for playing back files in a preferred order while in normal playback mode etc.
[File Move] (<small>ESP</small> P.56)	Selected files can be moved or copied within or between memory storages.
[File Divide] (<small>ESP</small> P.59)	PCM files recorded by this recorder can be divided.

About music file

In cases where the recorder is unable to playback music files that have been transferred to it, check to make sure that the sampling rate and bit rate are in the range where playback is possible. Combinations of sampling rates and bit rates for music files which the recorder can playback are given below.

File format	Sampling frequency	Bit rate
WAV format	44.1 kHz, 48 kHz, 88.2 kHz, 96 kHz	16 bit or 24 bit
MP3 format	MPEG1 Layer3: 32 kHz, 44.1 kHz, 48 kHz MPEG2 Layer3: 16 kHz, 22.05 kHz, 24 kHz	From 8 kbps up to 320 kbps
WMA format	16 kHz, 22 kHz, 32 kHz, 44.1 kHz, 48 kHz	From 16 kbps up to 256 kbps

- Variable bitrate MP3 files (in which conversion bitrates can vary) may not play properly.
- For WAV files, this recorder can only play back those in the linear PCM format. WAV files other than these cannot be played back.
- This recorder is compatible with Microsoft Corporation DRM9, but not with DRM10.
- It is possible to playback the WMA files which are created by the Olympus Digital Voice Recorder.

Forwarding

While the recorder is during stop mode in the file display, press and hold the ►►| button.

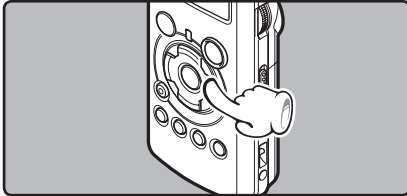

- [►►|] will appear on the display.
- If you release the ►►| button, it will stop. Press the ►/OK button to start playback from where it was stopped.

While the recorder is during playback mode, press and hold the ►►| button.

- When you release the ►►| button the recorder will resume normal playback.
- If there is an index mark or temp mark in the middle of the file, the recorder will stop at that location (see P. 35).
- The recorder stops when it reaches the end of the file. Continue pressing the ►►| button to proceed with the cue from the beginning of the next file.

Rewinding

While the recorder is during stop mode in the file display, press and hold the I◀◀ button.

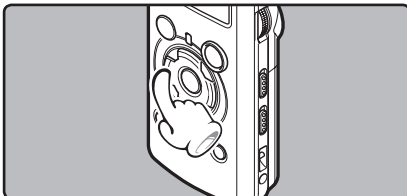

- [I◀◀] will appear on the display.
- If you release the I◀◀ button, it will stop. Press the ►/OK button to start playback from where it was stopped.

While the recorder is during playback mode, press and hold the I◀◀ button.

- When you release the I◀◀ button the recorder will resume normal playback.
- If there is an index mark or temp mark in the middle of the file, the recorder will stop at that location (see P. 35).
- The recorder stops when it reaches the beginning of the file. Continue pressing the I◀◀ button to proceed with the review from the end of the previous file.

Locating the Beginning of the File

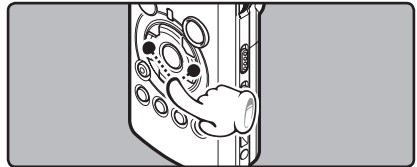

While the recorder is during stop mode or playback mode, press the ►►| button.

- The recorder skips to the beginning of the next file.

While the recorder is during playback mode, press the I◀◀ button.

- The recorder skips to the beginning of the current file.

While the recorder is during stop mode, press the I◀◀ button.

- The recorder skips to the beginning of the previous file. If the recorder stop the midway of the file, return to the beginning of the file.

While the recorder is during playback mode, press the I◀◀ button twice.

- The recorder skips to the beginning of the previous file.

Playback Through Earphone

An earphone can be connected to the **EAR** jack of the recorder for listening.

- When the earphone is used, the recorder speaker will be switched-off.

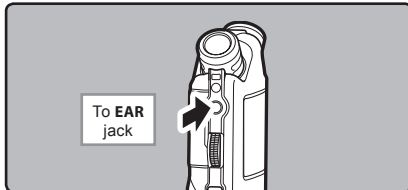

Notes

- When you skip to the beginning of the file during playback, the recorder will stop at the position of the index mark and temp mark. The index mark and temp mark will be skipped when you perform the operation in stop mode (P. 35).
- To avoid irritation to the ear, insert the earphone after turning down the volume level.
- When you listen with the earphone during playback, do not raise the volume too much. It may cause hearing impairment and decrease in hearing ability.

Setting an index mark or a temp mark

If index marks and temp marks are placed, you can quickly find a location you want to listen to in fast forward and fast rewind and when cueing a file.

Index and temp marks can be added only during PCM recording with this recorder or to PCM files recorded using this recorder. Index marks cannot be added to WMA files, MP3 files or files made by recorders other than Olympus IC recorders. However, temp marks can be added to temporarily mark locations to which you wish to listen.

To add index marks, the index function must be registered to the **Fn** button (P.48).

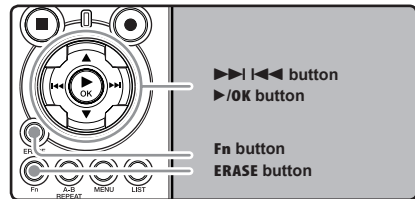

1 Press the Fn button during file recording, recording pause, playing, or playback pause.

- A number appears on the display and an index mark or temp mark will be placed.
- Even after an index or temp mark is placed, recording or playback will continue so you can place index or temp marks in other locations in a similar manner.

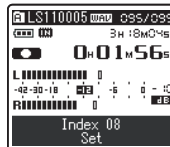

Clearing an index mark or a temp mark:

- 1 Locate the index or temp mark you want to clear.
- 2 Press the ►► or ◀◀ button to select the index or temp mark to erase.

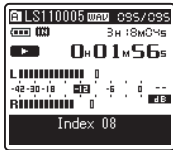

- 3 While the index or temp number appears for approximately 2 seconds on the display, Press the ERASE button.

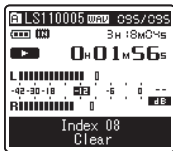

- The index or temp mark is erased.
- Index or temp numbers after the erased index or temp number will automatically move up.

Notes

- Index marks can be added during PCM recording with this recorder or to PCM files recorded using this recorder.

- Temp marks are temporary markings, so if you move to another file, switch to the list screen, or connect the recorder to a computer, they will be automatically erased.
- Up to 16 index and temp marks can be set in a file. If you try to place more than 16 index or temp marks, the [Index Full] message will appear for index marks, and [Temp Mark Full] for temp marks.
- Index or temp marks cannot be set or erased in a locked file (P.47).

How to begin segment repeat playback

This function enables repeated playback of part of the file being played.

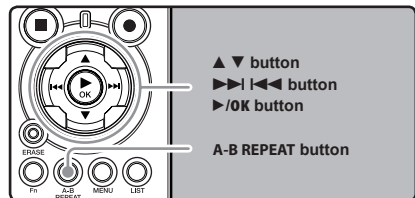

- 1 Select a file that has a segment you would like to play back repeatedly (P.19 to P.21).
- 2 In the File list display, press the ▲ or ▼ button to select the file.
 - In the File display, press the ►► or ◀◀ button to select a file.
- 3 Press the ►/OK button to start playback.

4 Press the A-B REPEAT button at the point you want to start segment repeat playback.

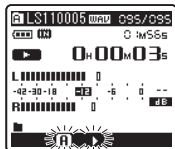

[A-B] will flash on the display

- Fast forwarding and rewinding (see P.29) can be conducted when [A-B] is flashing in the same manner as during normal playback, and you can quickly proceed as far as the end position (see P.34).
- When it reaches to the end of the file while [A-B] is flashing, the point will become the end position, and repeat playback will start.

5 Press the A-B REPEAT button again at the position where you want to end segment repeat playback.

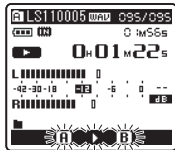

- The recorder repeatedly plays back the segment until the segment repeat playback is cancelled.

Cancel the segment repeat playback function

Pressing any of the following buttons will release the segment repeat playback.

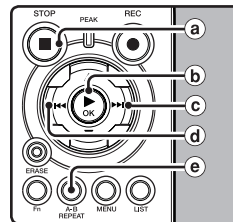

- Press the STOP ■ button**
Pressing the STOP ■ button will release segment repeat playback, and stop playback.
- Press the ►/OK button**
Pressing the ►/OK button will release segment repeat playback, and stop playback.
- Press the ►► button**
Pressing the ►► button will release segment repeat playback, and cue to the beginning of the next file.
- Press the ◀◀ button**
Pressing the ◀◀ button will release segment repeat playback, and reverse to the beginning of the current file.
- Press the A-B REPEAT button**
Pressing the A-B REPEAT button will release segment repeat playback, and playback continues without repeating.

Erasing

Erasing One File at a Time

A selected file can be erased from a folder.

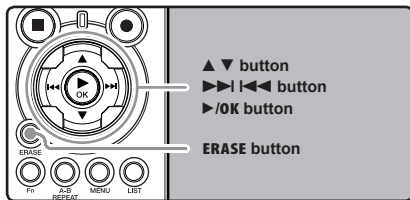

3

About Playback

1 Select the folder which contains the files you want to erase (see P.19 to P.21).

2 In the File list display, press the ▲ or ▼ button to select the file you want to erase.

- In the File display, press the ▶▶| or ◀◀| button to select a file.

3 While the recorder is during stop mode, press the ERASE button.



[Cancel] will flash on the display



4 Press the ▲ button to select [File Erase].



5 Press the ▶/OK button.



- The display changes to [File Erase!] and erasing will start.
- [Erase Done] is displayed when the file is erased. File numbers will be reassigned automatically.

Erase All Files from a Folder

All files in a folder can be erased simultaneously. The locked files (see P.41, P.47) and the files set to read-only on the PC will not be erased.

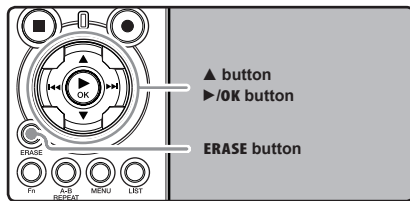

1 Select the folder that you want to erase (see P.19 to P.21).

2 While the recorder is during stop mode, press the ERASE button twice.



[Cancel] will flash on the display



3 Press the ▲ button to select [All Erase].

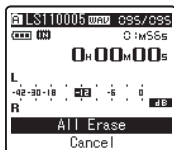

4 Press the ►/OK button.

- The display changes to [All Erase!] and erasing will start. [Erase Done] is displayed when the files are erased.

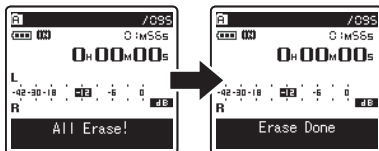

Partially erase a file

Only a PCM file recorded in the recorder can be partially erased.

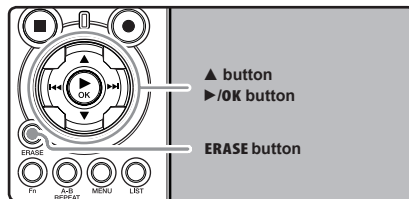

1 Select the folder which contains the files you want to partial erase (P.19 to P.21).

2 In the File list display, press the ▲ or ▼ button to select the file you want to partial erase.

- In the File display, press the ►► or ◀◀ button to select a file.

3 Play the file you want to partial erase.

- Forward a file to the position that shall be erased. If the file is long, use the ►►| button to move to the position you want to delete.

4 At the starting position of the partial erase, press the ERASE button.

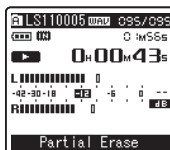

[Partial Erase] will flash on the display.

5 Press the ERASE button again.

- [Partial Erase Start Position] and [Partial Erase End Position] on the display flash alternately. When the lights are flashing, playback continues and you can rewind or fast-forward as usual and fast-forward to the end of erase. If the file reaches the end during the flashing of the lights, that will be the position where erase ends.

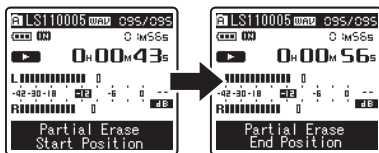

6 At the position you want to end partial erase, press the ERASE button again.

- The display will switch to [Partial Erasing !] and start the partial erase. The deletion is completed when [Partial erase completed] is displayed.
- Playback will stop at the end location of the partial erase.

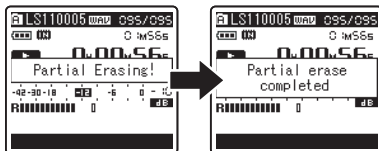

Notes

- Partial erase is not applicable to files recorded in the WMA or MP3 formats.
- The File Created Date will not change even if the file is partially erased.
- An erased file cannot be restored. When an SD Card is inserted in the recorder, be sure to confirm the recording media as either [Built-in Memory] or [SD Card] so that there is no mistake (see P.41, P.46).
- When attempting to perform operations such as rewriting the contents of an SD Card in cases where the card has been write protected, [SD Card Locked] will appear. The playback operation can be performed, but the write protection must first be turned off when overwriting the contents on the card (see P.18).
- The locked files and files set as read-only cannot be erased (see P.41, P.47).
- If an action is not selected within 8 seconds, the recorder will return to stop status.
- Never perform operations such as the following while processing, as they may damage the data. In addition, replace the batteries with two new ones in order to ensure that the batteries will not run out while processing.
 - ① Turning off the power while processing.
 - ② Removing the batteries while processing.
 - ③ Remove the SD Card during processing when [SD Card] is being used as the recording media.

Performing any of these operations may damage the data.

- You cannot delete folders through the recorder.

Menu Setting

Menu Setting Method

Items in menus are categorized by tabs, so select a tab first and move to a desired item to quickly set it. You can set each menu item as follows.

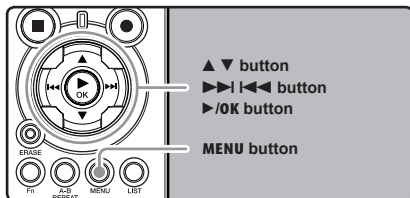

1 While the recorder is during stop mode, press the **MENU** button.

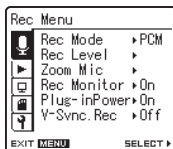

The menu will appear on the display

- Menu items can be set during a recording or playback (Ⓢ P.50).

2 Press the **▲** or **▼** button to move to the **tab** that contains the item you want to set.



- You can change the menu display by moving the settings tab cursor.

3 Press the **▶/OK** or **▶▶▶|** button to move the **cursor** to the item to set.



4 Press the **▲** or **▼** button to move to the item you want to set.

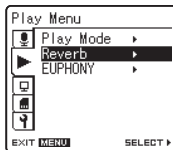

5 Press the **▶/OK** or **▶▶▶|** button.



- Moves to the setting of the selected item

6 Press the ▲ or ▼ button to change the setting.

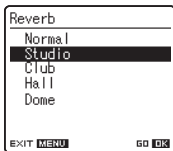

7 Press the ►/OK button to complete the setting.



- You will be informed that the settings have been established via the screen.
- Pressing the ◀◀ button without pressing the ►/OK button will cancel the settings and return you to the previous screen.

8 Press the MENU button to close the menu screen.

- When in the menu screen during recording or playback, pressing the ◀◀ or MENU button will allow you to return to the playback screen without interrupting recording or playback.

Notes

- The recorder will stop if you leave it idle for 3 minutes during a menu setup operation, when a selected item is not applied.
- When entering menu settings during recording or playback, the menu settings will be cancelled if 8 seconds elapse with no buttons being pressed.

■ Rec Menu

Rec Mode	<p>The recorder can record in the linear PCM format. High resolution recording at a high sampling rate and high bit rate equivalent or superior to that of a music CD is possible. Moreover, it also supports the MP3 and WMA formats.</p> <p>1. Select the recording format.</p> <p>Setting</p> <p>[PCM]: This is an uncompressed audio format which is used for music CDs and the like. [MP3]: MPEG is the international standard established by a working group of the ISO (International Organization for Standardization). [WMA]: This is an audio compression encoding method that was developed by the Microsoft Corporation in the US.</p> <p>2. Select the recording rate.</p> <p>Setting:</p> <p>[PCM]: [96kHz/24bit] to [44.1kHz/mono] [MP3]: [320kbps] to [mono] [WMA]: [160kbps] to [mono]</p> <ul style="list-style-type: none"> When the recording format is set to the MP3 or WMA formats, the sampling rate will be encoded and processed at 44.1 kHz. When a high recording rate setting is used the file capacity will increase. Make sure that the amount of memory remaining is sufficient before recording (☞ P.46). If the directional microphone function is used, you cannot change [PCM] setting in [Rec Mode] other than [44.1kHz/16 bit]. You use the all modes in [MP3] or [WMA] of [Rec Mode]. When [mono] of [MP3] is selected, the recording rate will be set to 64kbps. When [mono] of [WMA] is selected, the recording rate will be set to 32kbps.
Rec Level	<p>You can configure whether to adjust the recording level automatically or to adjust it manually.</p> <p>1. Select the Recording level setting.</p> <p>Setting</p> <p>[Manual]: Recording is performed by manually adjusting the recording level. When [Rec Level] is set to [Manual] you can configure the limiter function. [Auto]: Recording is performed by automatically adjusting the recording level. This is useful for when you will be recording right away.</p> <p>2. Select the Limiter setting.</p> <p>This recorder is equipped with a limiter function that corrects the recording level down to an appropriate range in cases where a loud noise is suddenly picked up. This prevents distortion caused by an excessive recording level.</p> <p>Setting:</p> <p>[Limiter On]: Enables the limiter function, thus preventing distortion when recording. [Limiter Off]: Disables this function.</p> <ul style="list-style-type: none"> When [Rec Level] is set to [Auto] the recording level will be adjusted automatically. Set [Rec Level] to [Manual] when using the recording level adjustment function and the limiter function.
Zoom Mic	<p>The directional microphone function utilizes DiMAGIC's (DiMAGIC Co., Ltd.) DiMAGIC Virtual Microphone (DVM) technology. DVM is an audio pickup system which allows you to record by focusing on sound from any direction. From expansive stereo recording to high directivity recording, DVM represents the latest in directional control methods that allow you to switch to a single exclusive microphone.</p> <p>Setting</p> <p>[Off]: Record in natural stereo sound. [Wide]: Record in expansive stereo sound. [Standard]: Record in slight directivity stereo sound in the front direction. [Narrow]: Record in directivity stereo sound. [Zoom]: Record in high directivity sound. (Monaural recording)</p> <ul style="list-style-type: none"> The directional microphone function has been designed so that this capability will be elicited only with the built-in stereo microphone. Please note that the recorder will become unable to record normally when using other commercially available microphones. You can use directional microphone only when [PCM] setting in [Rec Mode] is set to [44.1kHz/16 bit].

■ Rec Menu (Continued)

<h3>Rec Monitor</h3>	<p>Select whether or not to output audio while recording from the earphone jack.</p> <p>Setting</p> <p>[On]: Enables the recording monitor function. Sound will be output from the EAR jack.</p> <p>[Off]: Disables this function. Sound will not be output from the EAR jack.</p> <ul style="list-style-type: none"> • When the external speaker is connected while recording, there is a risk that audio feedback will occur. It is recommended that you use earphones for the recording monitor, or turn [Rec Monitor] to [Off] while recording (☞ P.27). • When [Rec Monitor] is set to [Off] no sound will come out of the earphones while you are recording (☞ P.27).
<h3>Plug-inPower</h3>	<p>External microphones which are supported by plug in power can also be used. Whether or not to supply power to external microphones can be configured.</p> <p>Setting</p> <p>[On]: When the plug-in power function is activated, power will be supplied to the connected external microphone. Select this when external microphones supported by plug-in power are connected (☞ P.30).</p> <p>[Off]: Disables this function. Select this when external microphones not supported by plug-in power are connected.</p> <ul style="list-style-type: none"> • Turn the plug-in power function to [Off] when an external microphone not supported by plug-in power is connected, as there is the risk that noise may be generated while recording. • Phantom power cannot be supplied, even when the plug in power function is set to [On].
<h3>V-Sync. Rec</h3>	<p>Voice sync recording starts when a voice louder than the voice sync level (detection level) is detected. When the voice becomes quiet, recording is automatically stopped. When voice sync recording is on and the voice is below the voice sync level (detection level) for longer than the specified detection time, the recorder stops.</p> <p>Setting</p> <p>[On]: [1 second] [2 seconds] [3 seconds] [4 seconds] [5 seconds] [10 seconds]: Sets the detection time. If the input (recording level) is equal to or below the specified level for longer than the specified detection time, the recorder stops.</p> <p>[Off]: Disables this function.</p>

<p>■ Play Menu</p> <p>Play Mode</p>	<p>There are six play modes. You can select whether to play by file or folder, or all files stored in the recorder.</p> <p>Setting: [File]: Stop after playing back the current file. [File Repeat]: Play the current file repeatedly. [Folder]: Play files continuously in the current folder until the last file and stop. [Folder Repeat]: Play all files in the current folder continuously. [All]: Play all files in the selected memory continuously and stop. [All Repeat]: Play all files in the selected memory continuously and repeatedly.</p> <ul style="list-style-type: none"> • In [File] mode, when the recorder comes to the end of the last file in the folder, [End] flashes for two seconds on the display and the recorder stops at the start of the last file. • In [Folder] mode, when the recorder comes to the end of the last file in the folder, [End] flashes for two seconds on the display and the recorder stops at the start of the first file in the folder. • In [All] mode, after playing the last file in the folder, the recorder will start playing from the first file in the next folder. When it comes to the end of the last file in the recorder, [End] flashes for two seconds on the display and the recorder stops at the start of the first file in the recorder.
<p>Reverb</p>	<p>You can enjoy the reverberant sound of various space sizes such as from the recording studio to the dome.</p> <p>Setting [Normal]: Disables the reverb function. Select this when playing back original sounds as they are. [Studio] [Club] [Hall] [Dome]: Select the preferred acoustical environment.</p> <ul style="list-style-type: none"> • When playing back WAV format files using these playback results, the sampling rate and bit rate will be converted downward from 96 kHz to 48 kHz and 24 bit to 16 bit, respectively. • This function is only available during playback. This recorder cannot perform recording by using the playback results. • When you adjust the various sound quality settings related to playback on the recorder, the audio output signal sent out from the EAR jack will change as well.
<p>EUPHONY</p>	<p>This recorder is equipped with "EUPHONY MOBILE", the latest in surround sound systems which combines bandwidth correction, expansion technology, and virtual acoustical source processing technology. In addition to its natural, expansive feel, the recorder is equipped with the exceptional feature wherein listeners are less prone to developing an compressed or closed-in feel, or to growing tired over extended listening. On top of this, listeners are less prone to developing an oppressed or closed-in feel, or to growing tired over extended listening. Level adjustments of the [EUPHONY] setting can be set to four stages according to preference.</p> <p>Setting: [Normal]: Disables this function. Select this when playing back original sounds as they are. [Natural]: This mode achieves natural bandwidth correction and acoustical field expansion. [Wide]: This mode has an even more expansive feel. [Power]: This mode focuses more on lower sound registers.</p> <ul style="list-style-type: none"> • When playing back WAV format files using these playback results, the sampling rate and bit rate will be converted downward from 96 kHz to 48 kHz, 88.2kHz to 44.1kHz and 24 bit to 16 bit, respectively. • This function is only available during playback. This recorder cannot perform recording by using the playback results. • When you adjust the various sound quality settings related to playback on the recorder, the audio output signal sent out from the EAR jack will change as well.

■ LCD/Sound Menu

Backlight	<p>The display will remain lit for about 10 (Initial setting) seconds when a button on the recorder is pressed.</p> <p>Setting [5 seconds] [10 seconds] [30 seconds] [60 seconds] [Always on]: Set the length of time that the backlight will remain lit. [Off]: Disables this function. The backlight will not light up.</p>
Contrast	<p>Display contrast can be adjusted in 12 levels.</p> <p>Setting: You can adjust the LCD display contrast level from [01] to [12].</p>
LED	<p>You can set it so the LED indicator light does not turn on.</p> <p>Setting [On]: LED light will be set. [Off]: Disables this function. LED light will be cancelled.</p>
Language	<p>You can select the display language for this recorder.</p> <p>Setting [English] [Français] [Deutsch] [Italiano] [Español] [Русский]</p> <ul style="list-style-type: none"> The selectable language differs depending on the region.

■ Memory Menu

MemorySelect	<p>When an SD Card is inserted you can select to record to either the built-in flash memory or to the SD Card (☞ P.14).</p> <p>Setting [Built-in Memory]: Built-in flash memory. [SD Card]: SD Card.</p> <ul style="list-style-type: none"> When attempting to perform operations such as rewriting the contents of an SD Card in cases where the card has been write protected, [SD Card Locked] will appear. The playback operation can be performed, but the write protection must first be turned off when overwriting the contents on the card (☞ P.18).
Memory Info.	<p>The recordable capacity remaining and overall capacity of the recording media can seen from the menu screen.</p> <ul style="list-style-type: none"> When no SD Card is inserted only information for the built-in flash memory will seen. The domain area which uses the administrative files which the recorder uses is included in the remaining capacity for the recording media. For SD cards in particular, in addition to this administrative domain the administrative domain area for the SD card is added in as well. Owing to this, the remaining capacity will be displayed as less than the card's specified capacity, yet this is not abnormal.
Format	(☞ P.51)

■ Others

Lock	<p>Locking a file keeps important data from being accidentally erased. Locked files are not erased when you select to erase all files from a folder (☞ P.38).</p> <p>Setting [On]: Locks the file and prevents it from being erased. [Off]: Disables this function. Unlocks the file and allows it to be erased.</p> <ul style="list-style-type: none"> • Select the files to be locked in advance before operating the menu. • When attempting to perform operations such as rewriting the contents of an SD Card in cases where the card has been write protected, [SD Card Locked] will appear. The playback operation can be performed, but the write protection must first be turned off when overwriting the contents on the card (☞ P.18).
Replace	(☞ P.54)
File Move	(☞ P.56)
File Divide	(☞ P.59)
AutoPowerOff	<p>Forgetting to turn the power off can be prevented. If the recorder remains in stop mode for over 10 minutes (Initial setting) while the power is turned on, the power will be turned off.</p> <p>Setting [5 minutes] [10 minutes] [30 minutes] [60 minutes]: Set the length of time before the power will be turned off. [Off]: Disables this function.</p> <ul style="list-style-type: none"> • If any button is pressed, the elapsed time count before the power turns off will start over again.
USB Settings	<p>There are two USB settings when connecting the recorder to a computer using the supplied USB cable. [Storage Class] is used when using the recorder as an external storage device. [Audio Class] is used when using the recorder as a USB microphone.</p> <p>Setting: [Storage Class]: The recorder is recognized as an external storage device by the computer. [Audio Class]: Use this setting when connecting the recorder to a computer as a USB microphone.</p>
Time & Date	(☞ P.15)

■ Others (Continued)

Fn Setting

When functions are registered in the **Fn** button, each time the **Fn** button is pressed, you can set or change the menu of registered function.

Setting:

[Off]: No functions will be allocated to the button.

[Index] (☞ P.35)

[Rec Mode] (☞ P.43)

[Rec Level]: (☞ P.43)

[Zoom Mic] (☞ P.43)

[Play Mode] (☞ P.45)

[Reverb] (☞ P.45)

[EUPHONY] (☞ P.45)

[MemorySelect] (☞ P.46)

[Property] (☞ P.49)

[Light] (☞ P.46)

To call up a registered function:

When the **Fn** button is pressed, menu setting display of registered function will appear:

[Rec Mode]:

[PCM] [MP3] [WMA]: The recording rate can be configured for each file format.

[Rec Level]:

[Manual] [Auto]: You can configure whether to adjust the recording level automatically or to adjust it manually. When the [Rec Level] is set to [Manual] you can configure the limiter function.

[Zoom Mic]:

[Off] [Wide] [Standard] [Narrow] [Zoom]

[Play Mode]:

[File] [File Repeat] [Folder] [Folder Repeat] [All] [All Repeat]

[Reverb]:

[Normal] [Studio] [Club] [Hall] [Dome]

[EUPHONY]:

[Normal] [Natural] [Wide] [Power]

[MemorySelect]:

[Built-in Memory] [SD card]

[Property]:

File and folder information can be confirmed from the menu screen.

Each time the **Fn** button is pressed, the setting of registered function is changed:

[Light]:

[On] [Off]: Select backlight on or off by pressing the **Fn** button.

If the **Fn** button is pressed during recording or playback, the registered function is performed:

[Index]:

With each press of the **Fn** button, an index mark or temp mark is added.

- When the registered function is [Rec Mode], [MemorySelect], or [Property], these will not function if the **Fn** button is pressed during recording or playback. While the recorder is during stop mode, press the **Fn** button.

■ Others (Continued)

Menu Reset

This returns the functions back to their initial settings (factory default).

Setting

[Start]: Returns the settings to their initial values.

[Cancel]: Takes you back to the [Others].

- After resetting the settings, the time settings and file numbers will be preserved from before the reset and will not return to their initial settings.

Menu settings after setting reset (initial settings):

■ Rec Menu [Rec Mode] Recording format [PCM] Recording rate [44.1kHz/16bit]	■ LCD/Sound Menu [Backlight] [10 seconds] [Contrast] [06] [LED] [On]
[Rec Level] Recording level [Manual] Limiter function [Limiter On]	■ Memory Menu [MemorySelect] [Built-in Memory]
[Zoom Mic] [Rec Monitor] [On] [Plug-inPower] [On] [V-Sync. Rec] [Off]	■ Other [AutoPowerOff] [10 minutes] [USB Settings] [Storage] [Fn Setting] [Off]
■ Play Menu [Play Mode] [File] [Reverb] [Normal] [EUPHONY] [Normal]	

System Info.

You can check the recorder's information on the menu screen. [Model Name], [Version] and [Serial Number] appears on the display.

Property

File and folder information can be confirmed from the menu screen.

When the file is selected: [Name] [Date] [Size] [Length] and [File Format] will appear on the display.

When the folder is selected: [Name] and [Date] will appear on the display.

- Select the files for which you would like to confirm information in advance before operating the menu.

◆ Setting menu during recording

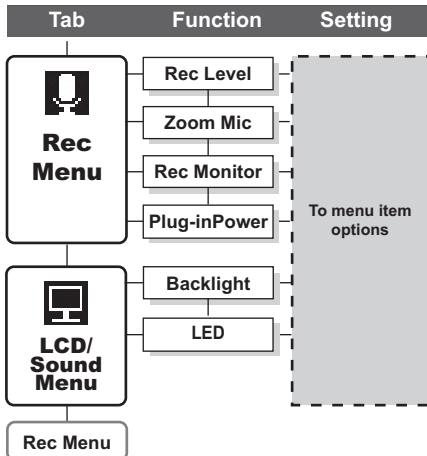

◆ Setting menu during playback

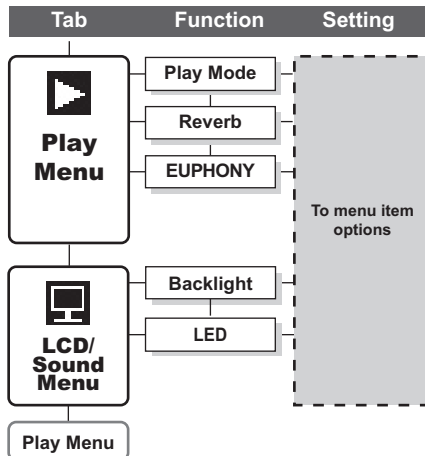

Formatting the Recorder (Format)

If you format the recorder, all files will be removed and all function settings will return to defaults except date and time settings. Transfer any important files to a computer before formatting the recorder.

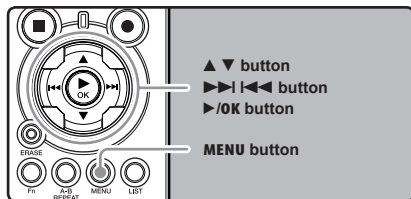

1 While the recorder is during stop mode, press the **MENU** button.

- The menu will appear on the display (P.41).

2 Press the **▲** or **▼** button to select **[Memory Menu]** tab.

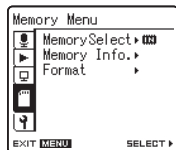

- You can change the menu display by moving the settings tab cursor.

3 Press the **▶/OK** or **▶▶|** button to move the cursor to the item to set.

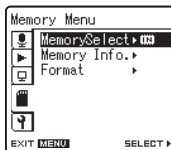

[Memory Menu] will appear on the display

4 Press the **▲** or **▼** button to select **[Format]**.

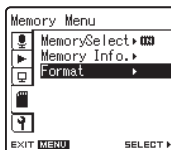

5 Press the **▶/OK** or **▶▶|** button.



[Format] will appear on the display

6 Press the **▲** or **▼** button to select the recording media to format.

- When formatting an SD Card, cancel the write protection function before inserting the card into the recorder (P.18).

7 Press the ►/OK button.



[Cancel] will appear on the display

8 Press the ▲ button to select [Start].

9 Press the ►/OK button.

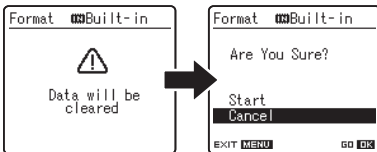

- After the [Data will be cleared] message is on for two seconds, [Cancel] will turn on.

10 Press the ▲ button again to select [Start].



11 Press the ►/OK button.

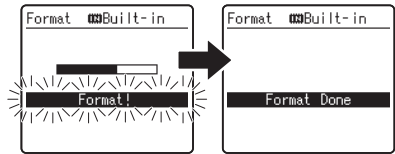

- Formatting begins and [Format !] flashes on the display.
- [Format Done] appears when formatting ends.

Notes

- When an SD Card is inserted in the recorder, be sure to confirm the recording media as either [Built-in Memory] or [SD Card] so that there is no mistake (☞ P.41, P.46).
- When attempting to perform operations such as rewriting the contents of an SD Card in cases where the card has been write protected, [SD Card Locked] will appear. The playback operation can be performed, but the write protection must first be turned off when overwriting the contents on the card (☞ P.18).
- Never perform operations such as the following while processing, as they may damage the data. In addition, replace the batteries with two new ones in order to ensure that the batteries will not run out while processing.
 - ① Turning off the power while processing.
 - ② Removing the batteries while processing.
 - ③ Remove the SD Card during processing when [SD Card] is being used as the recording media.

Performing any of these operations may damage the data.

- Never format the recorder from a PC.
- Once the recorder is formatted, the music files with DRM may not be transferred to the recorder again.

- When the recorder is formatted, all the saved data, including locked files and read-only files, are erased.
- After formatting, recorded audio file names may start from [0001].
- When returning the settings for the functions to their initial settings, use [**Menu Reset**] (☞ P.41, P.49).
- Formatting on the recorder will be Quick Format. If you format the SD card, information of file management is refreshed and the data inside the SD card is not deleted completely. When handing over and disposing the SD card, be careful about the data leakage from the SD card. We recommend the SD card to be destroyed when you dispose the SD card.

Rearranging files (Replace)

You can move a file in a folder to change the order of playback. First select the folder (file) for which you want to change the playback order.

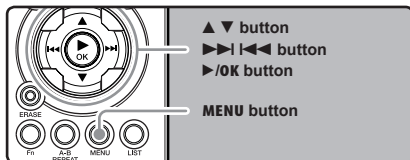

4

Menu Setting

1 Select the folder for which you would like to rearrange the song order (P.17 to P.21).

2 While the recorder is during stop mode, press the **MENU** button.

- The menu will appear on the display (P.41).

3 Press the **▲** or **▼** button to select [Others] tab.



- You can change the menu display by moving the settings tab cursor.

4 Press the **▶/OK** or **▶▶|** button to move the cursor to the item to set.

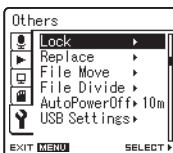

[Others] will appear on the display.

5 Press the **▲** or **▼** button to select [Replace].

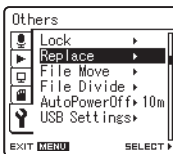

6 Press the **▶/OK** or **▶▶|** button.

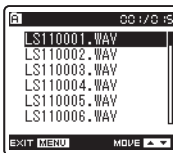

7 Press the **▲** or **▼** button to select the file you want to move.

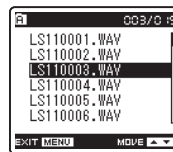

8 Press the ►/OK or ►►I button.

- The cursor will flash to confirm that the file can be moved.

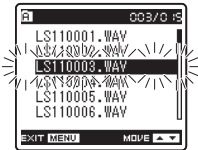

9 Press the ▲ or ▼ button to select the location to move it to.

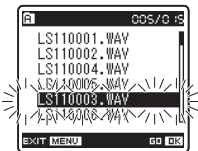

10 Press the ►/OK button to complete the setting.

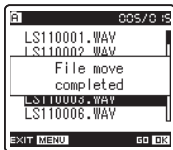

- If there are more files to move, repeat Steps 7 through 10.
- Pressing the ◀◀ button without pressing the ►/OK button will cancel the settings and return you to the previous screen.

11 Press the MENU button to close the menu screen.

Note

- When attempting to perform operations such as rewriting the contents of an SD Card in cases where the card has been write protected, [SD Card Locked] will appear. The playback operation can be performed, but the write protection must first be turned off when overwriting the contents on the card (see P.18).

Moving Files (File Move)

Files saved in the built-in memory or the SD card can be moved or copied within the memory. Files can also be moved or copied between memory.

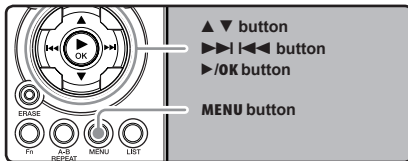

4

Menu Setting

1 Select the folder where the file you want to move or copy is saved.

2 In the File list display, press the ▲ or ▼ button to select the file you want to move or copy.

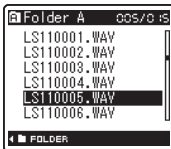

- In the File display, press the ▶▶| or ◀◀ button to select a file.

3 While the recorder is during stop mode, press the MENU button.

- The menu will appear on the display (P.41).

4 Press the ▲ or ▼ button to select [Others] tab.



- You can change the menu display by moving the settings tab cursor.

5 Press the ▶/OK or ▶▶| button to move the cursor to the item to set.

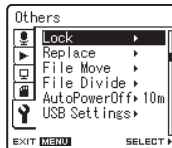

6 Press the ▲ or ▼ button to select [File Move].



7 Press the ►/OK or ►►/I button.



[File Move] will appear on the display

8 Press the ▲ or ▼ button to choose the position to move or copy the file to.

[Move to Built-in]:

Move a file in the built-in memory or SD card to another folder within the built-in memory.

[Copy to Built-in]:

Copy a file in the built-in memory or SD card to another folder within the built-in memory.

[Move to SD Card]:

Move a file in the built-in memory or SD card to another folder in the SD card.

[Copy to SD Card]:

Copy a file in the built-in memory or SD card to another folder in the SD card.

9 Press the ►/OK or ►►/I button.

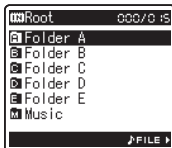

A Move or Copy folder selection screen is displayed.

10 Press the ▲ or ▼ button to select the folder you want to move or copy the file to.

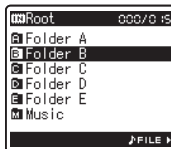

11 Press the ►/OK button to complete the setting.

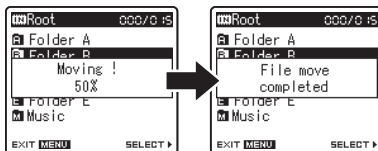

- [Moving!] or [Copying!] will appear on the display and moving or copying will start. During the process, the progress status will be shown in percentage. The process is completed when [File move completed] or [File copy completed] is displayed.

12 Press the MENU button to close the menu screen.

Notes

- The recorder cannot copy when the memory capacity is not sufficient.
- The recorder cannot move or copy when the number of file exceeds 199.
- Do not remove the batteries during moving or copying. This may damage the datas.
- A file cannot be moved or copied to the same folder.
- If there is a file with the same name in the move/copy destination folder, **[Cannot move. Same name file exists]** or **[Cannot copy. Same name file exists]** is displayed. The file will not be overwritten.
- When the operation is cancelled during moving or copying, the move or copy is cancelled.
- Files which are locked will remain so even after they are moved or copied.
- If you attempt to rewrite the contents in the SD card when the SD card is write protected, **[SD Card Locked]** will appear. The playback operation can be performed, but the write protection must first be turned off when overwriting the contents on the card (P.18).
- DRM files cannot be moved or copied.
- Files cannot be moved or copied directly under the **[Root]** folder.

Splitting Files [File Divide]

PCM files recorded in this recorder can be split. Files with large capacities and long recording times can be split so that they are easier to manage and edit.

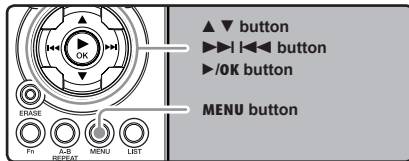

- 1 Select the PCM file you want to split, play or fast-forward the file and stop at where you want to split the file.

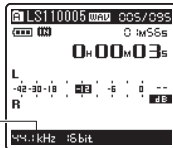

- Files with the recording mode of [96kHz], [88.2kHz], [48kHz] or [44.1kHz] are files recorded in the PCM format.
- a Recording mode

- 2 While the recorder is during stop mode, press the MENU button.
 - The menu will appear on the display (see P.41).

- 3 Press the ▲ or ▼ button to select [Others] tab.



- You can change the menu display by moving the settings tab cursor.

- 4 Press the ▶/OK or ▶▶| button to move the cursor to the item to set.

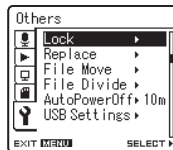

[Others] will appear on the display

- 5 Press the ▲ or ▼ button to select [File Divide].

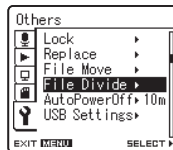

6 Press the ►/OK or ►►/I button.

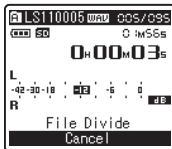

[File Divide] will appear on the display.

7 Press the ▲ or ▼ button to select [File Divide].

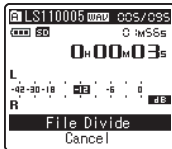

8 Press the ►/OK or ►►/I button.

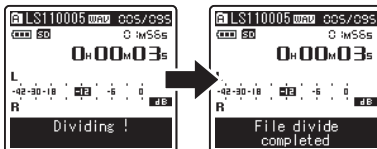

- [Dividing!] will be displayed and file splitting will start. Splitting is completed when [File divide completed] is displayed.

9 Press the MENU button to close the menu screen.

Notes

- The file split cannot be done when the file list is displayed.
- The recorder cannot split files when the number of files in the folder exceeds 199.
- Locked files (see P.41, P.47) cannot be split.
- After a file has been split, the original file will be renamed [File name_1.WAV] and the new file will be named [File name_2.WAV].
- After a file has been split, the resulting files retain the same creation date and modification date as the original file.
- If a file has an extremely short recording time, it may not be split even if it is a PCM file.
- Do not remove the batteries during splitting file. This may damage the data.

Using the Recorder on Your PC

By being connected to a PC, the recorder enables you to do the following:

- You can transfer files recorded with this recorder to a computer, play them back, and manage them by using Windows Media Player or iTunes (☞ P.65, P.72).
- In addition to its uses as an IC recorder and a music player, this recorder can also be used as external memory for a computer by storing data from a computer and reading it back out (☞ P.64, P.76).

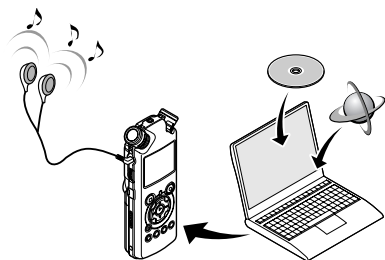

Operating Environment

Windows

Operating System:

Microsoft Windows XP/Vista (Standard Installation)

Compatible PC's:

Windows PC's equipped with more than one free USB port

Macintosh

Operating System:

Mac OS X 10.4.11 ~ 10.5 (Standard Installation)

Compatible PC's:

Apple Macintosh series equipped with more than one free USB port

Notes

- This is an operational environment for saving the files recorded by this recorder to your PC with USB connection.
- To check the operational environment of **[Olympus Sonority]** software, see a supplied separate sheet.
- Even if operational environment is satisfied, we do not support such as 64-bits OS, the multi-boot environment and self-modified PC's.
- Even if operational environment is satisfied, we do not support such as upgraded OS, the multi-boot environment and self-modified PC's.

Precautions on using the recorder connected to a PC

- When you are downloading a file from the recorder or uploading a file to the recorder, do not remove the USB cable even if the screen is indicating you can. Data is still being transferred while the **[PEAK]** indicator light is blinking. When removing the USB cable, be sure to follow the description in ☞ P.63. If the USB cable is removed before the drive is stopped, data may not be successfully transferred.
- On a PC, do not format the drive of the recorder. Initialization is not successfully achieved on a PC. For initialization, follow the instructions in the **[Format]** screen of the recorder (☞ P.51).
- Folder (directory) names appeared by file management tools such as Explorer attached to Microsoft Windows is different from the folder names that can be set with the recorder.
- If folders or files stored on the recorder are moved or renamed by using a file management tool such as Explorer, the order of files may be changed or files may become unrecognizable
- Data can be written or uploaded to the recorder even though the attribute of the recorder drive is shown as Read-only by the operating system of the PC.
- As the noise may cause adverse effects on electronics devices nearby the recorder, unplug the earphone when you connect the recorder to a PC.

Copyright and Copyright Protection Feature (DRM)

By the Copyright Act, any voice/music files and music CDs downloaded from the Internet without the copyright holder's permission may not be reproduced, distributed, publicized/re-publicized on the Internet, or converted into WMA or MP3 files for the purpose of commercial business or sale.

A WMA file may be provided with DRM (Digital Right Management) for copyright protection. DRM limits the file to copy or distribute music files that are converted (ripped) from a music CD or downloaded from music distribution services. To transfer a WMA file with DRM to the recorder, you need to use appropriate methods such as Windows Media Player. Copying the music files with DRM purchased from online music distribution service to a portable device such as this recorder may be restricted.

Note

- This recorder is compatible with Microsoft Corporation DRM9, but not with DRM10.

Connecting to Your PC

Connecting to Your PC

- 1 Boot the PC.
- 2 Connect the USB connecting cable to the USB port of the PC.

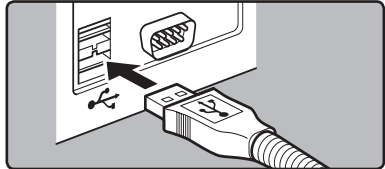

- 3 Confirm that the recorder has stopped and connect a USB connection cable to the connection port on the side of recorder.

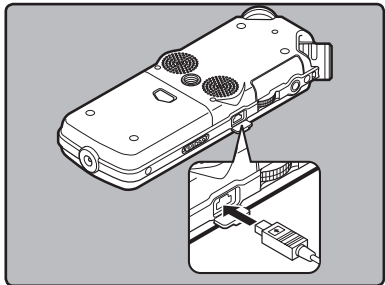

Windows:

When you open **[My Computer]**, it will be recognized by the drive name **[LS_11]** (Built-in flash memory) and **[Removable Disk]** (SD card).

Macintosh:

When you connect the recorder to a Mac OS, it will be recognized by the drive name **[LS_11]** on the desktop. When an SD card is inserted it will be recognized by the drive name **[Untitled]**.



[Connect (Storage)] is appeared on recorder if the USB cable is connected

Note

- Be sure to use the attached dedicated cable for the USB connection cable. If any other company's cable is used, it cause problems. Also, please do not connect this dedicated cable to any other company's product.

Disconnecting from Your PC

Windows

- 1 Click [] on the task bar located at the lower-right corner of the screen. Click [Safely remove USB Mass Storage Device].



- The drive letter will differ depending on the PC being used.

- 2 When the safe to remove hardware window appears, click [OK].
- 3 Disconnect the USB connection cable.

Macintosh

- 1 Move the drive icon for this recorder that is appear on the desktop to the garbage bin by Drag & Drop it.

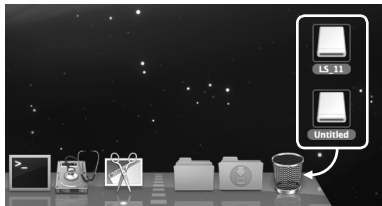

- When you connect the recorder to a Mac OS, it will be recognized by the drive name [LS_11] on the desktop. When an SD card is inserted it will be recognized by the drive name [Untitled].

- 2 Disconnect the USB cable.

Notes

- NEVER disconnect the USB while the [PEAK] indicator light is flashing. If you do, the data will be destroyed.
- When the recorder is connected to a PC, the power will be supplied from the USB cable.
- Refer to the user's manual for your PC regarding the USB port on your PC.
- Be sure that you connect the USB cable either directly to the USB port on your PC.
- Be sure to push the cable connector all the way in. Otherwise, the recorder may not operate properly.
- When connecting the recorder through an USB hub the operation may become unstable. In such cases, refrain from using a USB hub.

Transfer the Voice Files to Your PC

The 5 voice folders of this recorder are appeared as [DSS_FLDA], [DSS_FLDB], [DSS_FLDC], [DSS_FLDD] and [DSS_FLDE], and the recorded voice files are saved in these folders.

Windows

1 Connecting the recorder to your PC (P.62).

2 Open the Explorer window.

3 Open the [LS_11] folder.

- When you open [My Computer], it will be recognized by the drive name [LS_11] (Built-in flash memory) and [Removable Disk] (SD card) (The drive letter will differ depending on the PC being used).

5

4 Copy the data.

5 Disconnecting the recorder to your PC (P.63).

Macintosh

1 Connecting the recorder to your PC (P.62).

- When you connect the recorder to a Mac OS, it will be recognized by the drive name [LS_11] on the desktop. When an SD card is inserted it will be recognized by the drive name [Untitled].

2 Double-click on [LS_11] icon on the desktop.

3 Copy the data.

4 Disconnecting the recorder to your PC (P.63).

Drive name and folder name when a personal computer is connected:

Built-in flash memory

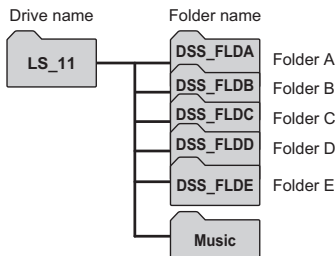

SD card

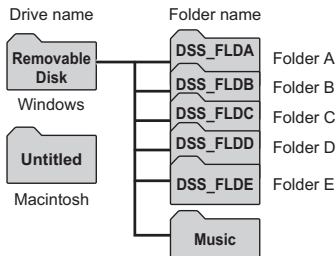

Notes

- While transmitting data, [Busy] is appeared, and the [PEAK] indicator light flashes. NEVER disconnect the USB while the [PEAK] indicator light is flashing. If you do, the data will be destroyed.
- In the Windows operational environment 24 bit WAV format files cannot be played back.
- When a sound board of your PC does not support to 24 bit, the recorder cannot play the software supporting to 24 bit correctly.
- In the Mac OS operational environment, WMA format files cannot be played back.

Using Windows Media Player

By using Windows Media Player, music files from music CDs or language study CDs can be imported to your PC (P.66) and music files that you have bought from any music distribution sites can be easily transferred to the recorder to play (P.67). The files recorded on the recorder can be transferred to your PC and can be copied to CD (P.70). It supports WAV, MP3, and WMA format music files.

Window Names

Windows Media Player 11

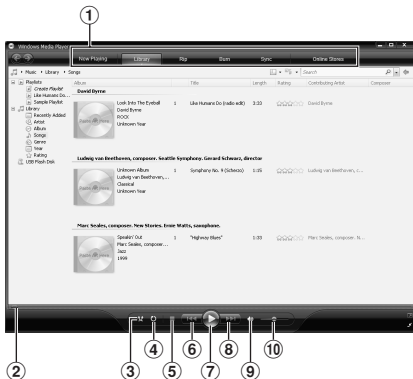

- 1 Features taskbar
- 2 Seek slider
- 3 Shuffle button
- 4 Repeat button
- 5 Stop button
- 6 Previous button
- 7 Play button
- 8 Next button
- 9 Mute button
- 10 Volume slider

Windows Media Player 10

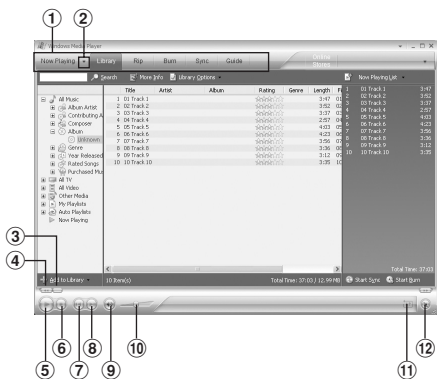

- 1 Features taskbar
- 2 Quick Access Panel button
- 3 Seek slider
- 4 Rewind button
- 5 Play button
- 6 Stop button
- 7 Previous button
- 8 Next button
- 9 Mute button
- 10 Volume slide
- 11 Shuffle/ Repeat button
- 12 Fast Forward button

Copying Music from CD

- 1 Insert CD into the CD-ROM drive, and start Windows Media Player.
- 2 From the Features taskbar, click **[Rip]** menu.
 - After clicking **[Rip]** menu, click **[View Album Info]** for Windows Media Player 10 as necessary.
 - If Internet connectivity is available, CD information is searched.
- 3 Put a check mark on the music file that you want to copy.
- 4 Click **[Start Rip]**.
 - For Windows Media Player 10 Click **[Rip Music]**.
 - Files copied to a PC are stored in WMA format. Music files copied are categorized by artist, album, genre, etc. and added to the play list.

Windows Media Player 11



Windows Media Player 10

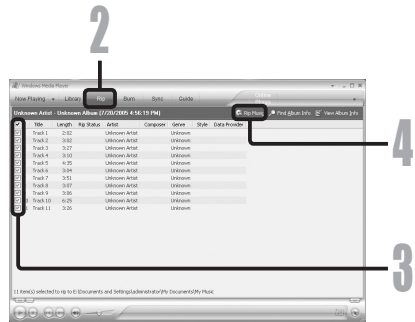

Transferring Music File to the Recorder

You can transfer the music files saved in your PC to this recorder. For how to copy the music files from the CD to your PC, see “**Copying Music from CD**” (#3 P.66).

Windows Media Player 11

- 1 Connect the recorder to a PC, and start Windows Media Player.
- 2 From the Features taskbar, click [Sync].
- 3 Click [Sync] menu again to select [DVR] → [Advanced Options] → [Set Up Sync], and set as follows.
 - Click on the [Create folder hierarchy on device] to check. *1 *2
 - The folder with artist name or album name is automatically created. This will make you find the file you want to listen to more easily.

*1 If [Create folder hierarchy on device] is checked by default, click to uncheck the box once, and click it again to check.

*2 After the synchronous transfer to the recorder, a file named “WMPInfo.xml” is created. If you delete this file, the *1 may need to be set again.

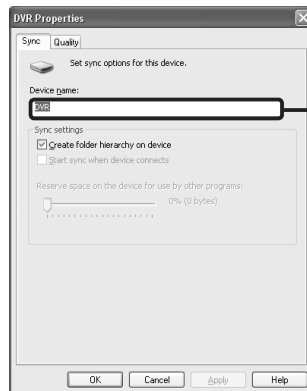

4 Select the desired category from [Library] on the left, and select music files or albums to transfer to the recorder, and Drag & Drop them in [Sync List] on the right.

5 Click [Start Sync].

- The file is transferred to the recorder.



Windows Media Player 10

5 **1** Connect the recorder to a PC, and start Windows Media Player.

2 From the Features taskbar, click [Sync].

3 From the pull down menu on the left side window, select the play list to be transferred to the recorder, and put the check marks on the music file that you want to transfer.

- The order of music pieces can be changed by Drag & Drop of the music file in the play list displayed.

4 From the pull down menu on the right side window, select the drive corresponding to the recorder.

- The recorder is recognized as a Removable Disk.

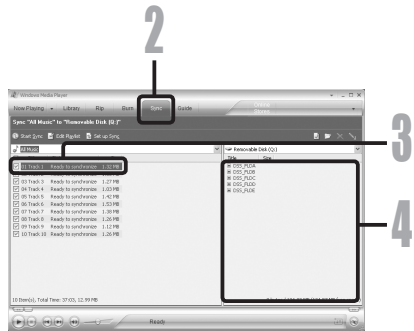

5 Click [] on the upper right corner, and set the synchronization options.

- Click on the [Create folder hierarchy on device] to check. *1 *2
- The folder with artist name or album name is automatically created. This will make you find the file you want to listen to more easily.

*1 If [Create folder hierarchy on device] is checked by default, click to uncheck the box once, and click it again to check.

*2 After the synchronous transfer to the recorder, a file named "WMPInfo.xml" is created. If you delete this file, the *1 may need to be set again.

6 Click [Start Sync].

- The file is transferred to the recorder. The music file transferred to the recorder is displayed in Item on Device.

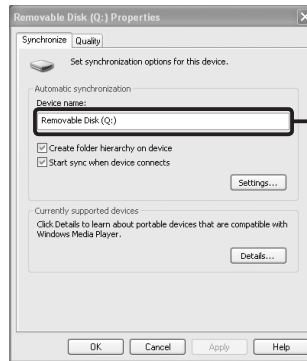
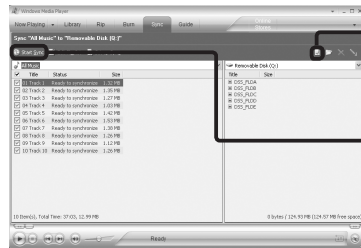

5

Using the Recorder on Your PC

Notes

- Copying the music files with DRM purchased online music distribution service to a portable device such as this recorder may be restricted.
- To transfer the files by using Windows Media Player 9, check the Olympus website.
- If the music files are transferred to the recorder until it reaches to the maximum memory, the message [Cannot make the system file. Connect to PC and delete unnecessary file] may appear on this recorder's display. In such a case, erase the files to make free space (hundreds of KB to dozens of MB depending on the music file sizes) for the management file (The more capacity for the management file will be necessary as the number of the music files increases).

Windows Media Player 10

- 1 Insert the blank CD-R/RW into the CD-R/RW drive, and start Windows Media Player.
- 2 From the Features taskbar, click [Burn] menu.
 - Click [Burn] as needed after clicking [Edit Playlist] menu.
 - You can change the order of tracks by Drag & Drop files.
- 3 Put a check mark on the voice files that you want to copy.

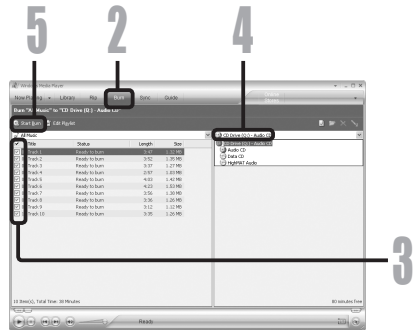

- 4 Select format of CD before clicking [Start Burn].

When [Audio CD] is selected:

- A file is converted and copied in CD in order to play it by the audio equipment which can play CD-R/RW.

When [Data CD] is selected:

- Copying files with the format to be recorded.

- 5 Click [Start Burn].

Notes

- Copying the music files with DRM purchased online music distribution service to a portable device such as this recorder may be restricted.
- Refer to the online help of Windows Media Player for details.

Using iTunes

By using iTunes, music files from music CDs or language study CDs can be imported to your PC (☞P.73) and music files that you have bought from any music distribution sites can be easily transferred to the recorder to play (☞P.74).The files recorded on the recorder can be transferred to your PC and can be copied to CD (☞P.75).

Window Names



- ① Features taskbar
- ② Rewind button/ Playback, Pause button/ Fast Forward button
- ③ Volume slide
- ④ Playlist addition button
- ⑤ Shuffle button
- ⑥ Repeat button
- ⑦ Display change button
- ⑧ Disc create button
- ⑨ Genius button
- ⑩ Genius side button

Copying Music from CD

- 1 Insert the CD into the CD-ROM drive, and start iTunes.
- 2 Click [iTunes] → [Preferences].
- 3 Click [General] tag.
- 4 Click [Import Settings] to set the file format and bit rate for copying music files to your PC, and click [OK].

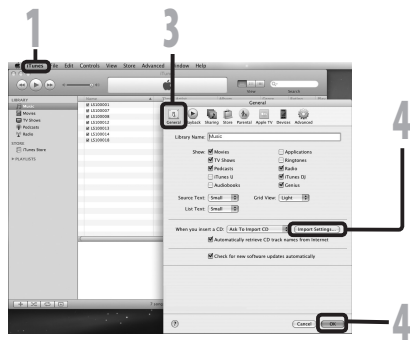

- This recorder is compatible with music files in the MP3 and WAV formats (Ⓜ P.33).

[Import Using]:

Set the file format for copying music file from a CD. Please select [MP3 Encoder] or [WAV Encoder].

[Setting]:

Set the bit rate for copying music file from a CD. You can select a bit rate between [128], [160] and [192].

- 5 Put a check mark on the music files that you want to copy.
- 6 Click [Import CD].



Transferring Music File to the Recorder

You can transfer the music files saved in your PC to this recorder. For how to copy the music files from the CD to your PC, see “**Copying Music from CD**” (P.73).

1 Connect the recorder to a PC, and start iTunes.

2 Select the play list to be transferred to the recorder, and put the check marks on the music files that you want to transfer.

- The order of music pieces can be changed by Drag & Drop of the music file in the play list displayed.



3 Double-click the corresponding drive with the recorder, and open [Music] folder.

- When you connect the recorder to a Mac OS, it will be recognized by the drive name [LS_11] on the desktop. When an SD card is inserted it will be recognized by the drive name [Untitled].
- Copy to [Music] folder of the recorder when transferring the music file.
- You can create up to 2 hierarchies in the [Music] folder. And up to 128 folders can be made including [Music] folder.
- Up to 200 files can be stored in each folder.



4 Select the desired files, and Drag & Drop them to [Music] folder.

Copying Voice File to the CD

You can transfer the voice files in the recorder to your PC and copy them to CD. For how to copy the voice files from the recorder to your PC, see “**Transfer the Voice Files to Your PC**” (P.64).

1 Insert the CD-R/RW into the CD-R/RW drive, and start iTunes.

2 Select the desired playlist, and put a check mark on the voice files to copy to the CD-R/RW.

3 Click **[Burn Disc]**.

4 To set the CD format for copying voice files to CD-R/RW, and click **[OK]**.

When **[Audio CD]** is selected:

- A file is converted and copied in music CD in order to play it by the audio equipment which can play CD-R/RW.

When **[MP3 CD]** is selected:

- Copying in MP3 format.

When **[Data CD]** is selected:

- Copying files with the format to be recorded.



Using as External Memory of the PC

In addition to its uses as an IC recorder and a music player, this recorder can also be used as external memory for a computer by storing data from a computer and reading it back out.

With the recorder connected to your PC, you can download data from the memory to your PC and upload data stored on your PC to the memory.

Note

- While transmitting data, [**Busy**] is displayed, and the [**PEAK**] indicator light flashes. NEVER disconnect the USB while the [**PEAK**] indicator light is flashing. If you do, the data will be destroyed.

Windows

- 1 Connecting the recorder to your PC (P.62).
- 2 Open the Explorer window.
- 3 Open the [LS_11] folder.
 - When you open [My Computer], it will be recognized by the drive name [LS_11] (Built-in flash memory) and [Removable Disk] (SD card) (The drive letter will differ depending on the PC being used).
- 4 Copy the data.
- 5 Disconnect the USB connection cable (P.63).

Macintosh

- 1 Connecting the recorder to your PC (P.62).
 - When you connect the recorder to a Mac OS, it will be recognized by the drive name [LS_11] on the desktop. When an SD card is inserted it will be recognized by the drive name [Untitled].
- 2 Double-click on [LS_11] icon on the desktop.
- 3 Copy the data.
- 4 Disconnect the USB connection cable (P.63).

Other Information

Alarm Message List

Message	Meaning	Explanation	Action
Battery Low	Low battery power.	Battery power is getting low.	Replace with new batteries (☞ P.11).
File Protected	Erase-locked.	Tried to delete a locked file.	Unlock the file (☞ P.41, P.47).
Can't record in this folder	Not an audio-recording folder.	Recording has been attempted with a [Music] folder.	Select a folder from [A] through to [G] and try recording again (☞ P.19 to P.21, P.23).
Folder Full	Folder full.	The folder is full of files (maximum of 200 files).	Erase unnecessary files (☞ P.38).
Memory Error	Error in the memory.	Error in the memory.	This is a malfunction, so go to the store where you purchased the recorder or an Olympus service station for repair.
		SD card is not recognized correctly.	Remove the SD card then put it again (☞ P.17 to P.18).
Licence Mismatch	Illegally copied file.	The music files copied illegally.	Erase the file (☞ P.38).
Memory Full	Zero remaining memory.	No remaining memory.	Erase unnecessary files (☞ P.38).
No File	No file.	No files were found in the folder.	Select another folder (☞ P.19 to P.21).
SD Card Locked	Card Locked.	The SD Card is set to write protection.	Undo the SD Card's write protection setting and then try again (☞ P.18).
Format Error	Formatting error.	There was an error while formatting the recorder's memory.	Reformat the memory (☞ P.51).
Can't make the system file. Connect to PC and delete unnecessary file	The management file cannot be created.	The file for management cannot be created due to a shortage of capacity for remaining memory.	Connect the recorder to a computer and delete any unnecessary files.
Data Write Error	The data is not written correctly in the memory.	Data writing to memory cannot be done in time and the recorded sound skips.	Format the memory (☞ P.51).

Troubleshooting

Symptom	Probable cause	Action
Nothing appears on the display	The batteries are not loaded properly.	Verify that the batteries' polarities ⊕ and ⊖ are correct (☞ P.11).
	Battery power is getting low.	Replace with new batteries (☞ P.11).
	The power is off.	Turn the power on (☞ P.13).
Won't start	Battery power is getting low.	Replace with new batteries (☞ P.11).
	The power is off.	Turn the power on (☞ P.13).
	The recorder is in HOLD mode.	Release the recorder from HOLD (☞ P.13).
Unable to record	Low remaining memory.	Erase unnecessary files (☞ P.38).
	The maximum number of files has been reached.	Change to the another folder (☞ P.19 to P.21, P.23).
	The SD Card is set to write protection.	Undo the SD Card's write protection setting and then try again (☞ P.18).
No sound picked up by the built-in microphone	An external microphone or external device is connected.	Detach all external microphones and external devices connected to the LINE IN jack and the MIC jack (☞ P.30, P.31).
Unable to record through an external microphone	An external device is connected to the LINE IN jack.	Detach the connecting cord from the recorder.
	An external microphone supported by plug-in power is connected but [Plug-in Power] is set to [Off].	Set [Plug-inPower] to [On] when an external microphone supported by plug-in power is connected (☞ P.41, P.44).
No playback tone heard	The earphone is connected.	Unplug the earphones to use the internal speaker.
	The volume level is set to [0].	Adjust the volume level (☞ P.32).
Recording level too low	The recording level has not been adjusted.	Adjust the recording level and then try recording once more (☞ P.26).
	The microphone sensitivity is too low.	Set the microphone sensitivity to [HIGH] mode and try again (☞ P.27).
	This could potentially be because the recording level and output level for the connected external devices are too low.	If you cannot record clearly even after adjusting the recording level, then adjust the output level for the connected devices (☞ P.23).
Recording level too high	The recording level has not been adjusted.	Adjust the recording level and then try recording once more (☞ P.23).
	This could potentially be because the recording level and output level for connected external devices are too high.	If you cannot record clearly even after adjusting the recording level, then adjust the output level for the connected devices (☞ P.23).

Symptom	Probable cause	Action
Voice files are not recorded in stereo	The connected external microphone is monaural.	When recording while an external monaural microphone is connected, sound will only be recorded by the L-channel.
Cannot find the recorded Voice File	Wrong recording media or folder.	Switch to the correct recording media or folder (☞ P.19 to P.20, P.23, P.41, P.46).
Noise heard during playback	The recorder was shaken during recording.	-----
	The recorder was placed near a cell phone or fluorescent lamp while recording or during playback.	Move the recorder.
	The settings of the connected external microphone do not correspond to those of the recorder.	When a microphone not supported by the plug-in power function is connected, turn the [Plug-inPower] setting to [Off] (☞ P.41, P.44).
Unable to erase	The file is locked.	Unlock the file (☞ P.41, P.47).
	The file is read-only.	Cancel the read-only setting of the file on the PC.
Unable to hear any sound from the earphone through the recording monitor	The [Rec Monitor] is set to [Off] .	Turn the [Rec Monitor] setting to [On] (☞ P.41, P.44).
Noise is audible through the recording monitor	Acoustic feedback is occurring.	When the built-in speaker amps and the like are connected there is a risk that audio feedback will occur while recording. It is recommended that you use earphones for the recording monitor, or turn the [Rec Monitor] to [Off] while recording (☞ P.41, P.44).
		Conduct adjustments like separating the earphones from the microphone farther, do not point the microphone at the earphones, lower the volume on the recording monitor, and so on.

Specifications

General points

- **Recording format:**
 - Linear PCM (Pulse Code Modulation)
 - MP3 (MPEG-1/MPEG-2 Audio Layer3)
 - WMA (Windows Media Audio)
- **Input level:**
 - MIC SENSE HIGH/LOW** switch is set to [**HIGH**]:
 - 59 dBv
 - MIC SENSE HIGH/LOW** switch is set to [**LOW**]:
 - 39 dBv
 - LINE IN** jack input:
 - 6 dBv
- **Maximum headphone output:**
 - 6.7 mW + 6.7 mW (at load of 16 Ω)
 - ≤ 150 mV (According to EN 50332-2)
- **Recording medium:**
 - Built-in NAND FLASH memory (8 GB)
 - SD card (512 MB to 32 GB)
- **Speaker:**
 - Built-in ø 16 mm round dynamic speaker
- **MIC jack:**
 - ø 3.5 mm mini-jack, impedance 2 kΩ
- **LINE IN jack:**
 - ø 3.5 mm mini-jack, impedance 78 kΩ (approx.)
- **EAR jack:**
 - ø 3.5 mm mini-jack, impedance 8 Ω or more
- **Maximum working output:**
 - 200 mW + 200 mW (8 Ω speaker)
- **Input power requirement:**
 - Batteries: Two AA batteries (LR6) or Two Ni-MH rechargeable batteries
 - External power supply: AC adapter 5 V
- **External dimensions:**
 - 131.5 mm × 48 mm × 22.4 mm (without protrusions)
- **Weight:**
 - 165 g (including alkaline batteries)

Overall frequency response:

- **LINE IN Jack (During recording or playback mode):**

Linear PCM format

Recording mode	Overall frequency response
96 kHz	20 Hz to 44 kHz
88.2 kHz	20 Hz to 42 kHz
48 kHz	20 Hz to 23 kHz
44.1 kHz	20 Hz to 21 kHz
44.1 kHz/mono	20 Hz to 21 kHz

MP3 format

Recording mode	Overall frequency response
320 kbps	50 Hz to 20 kHz
256 kbps	50 Hz to 20 kHz
128 kbps	50 Hz to 17 kHz
mono	50 Hz to 13 kHz

WMA format

Recording mode	Overall frequency response
160 kbps	50 Hz to 19 kHz
128 kbps	50 Hz to 19 kHz
64 kbps	50 Hz to 15 kHz
mono	50 Hz to 13 kHz

- **Built-in stereo microphone (During recording mode):**

60 Hz to 20 kHz

- However, when recording by the MP3 format or the WMA format, the upper limit value of the frequency response depends on each recording mode (see above diagram).

Guide to recording times

■ **Linear PCM format**

Recording mode	Built-in flash memory (8 GB)	SD card						
		512 MB	1 GB	2 GB	4 GB	8 GB	16 GB	32 GB
96 kHz 24 bit	3 h. 50 min.	10 min.	25 min.	55 min.	1 h. 50 min.	3 h. 45 min.	7 h. 30 min.	15 h. 25 min.
96 kHz 16 bit	5 h. 50 min.	20 min.	40 min.	1 h. 20 min.	2 h. 50 min.	5 h. 45 min.	11 h. 30 min.	23 h. 10 min.
88.2 kHz 24 bit	4 h. 10 min.	15 min.	30 min.	1 h.	2 h.	4 h. 10 min.	8 h. 15 min.	16 h. 45 min.
88.2 kHz 16 bit	6 h. 20 min.	20 min.	45 min.	1 h. 30 min.	3 h. 5 min.	6 h. 15 min.	12 h. 30 min.	25 h. 15 min.
48 kHz 24 bit	7 h. 45 min.	25 min.	55 min.	1 h. 50 min.	3 h. 50 min.	7 h. 40 min.	15 h.	31 h.
48 kHz 16 bit	11 h. 45 min.	40 min.	1 h. 25 min.	2 h. 50 min.	5 h. 45 min.	11 h. 30 min.	23 h.	46 h. 30 min.
44.1 kHz 24 bit	8 h. 30 min.	30 min.	1 h.	2 h.	4 h. 10 min.	8 h. 20 min.	16 h. 30 min.	33 h. 45 min.
44.1 kHz 16 bit	12 h. 45 min.	45 min.	1 h. 30 min.	3 h. 5 min.	6 h. 15 min.	12 h. 35 min.	25 h.	50 h. 40 min.
44.1 kHz mono	25 h. 40 min.	1 h. 25 min.	3 h.	4 h. 50 min.	12 h. 10 min.	24 h. 55 min.	50 h. 50 min.	101 h.

■ **MP3 format:**

Recording mode	Built-in flash memory (8 GB)	SD card						
		512 MB	1 GB	2 GB	4 GB	8 GB	16 GB	32 GB
320 kbps	56 h. 50 min.	3 h. 30 min.	7 h.	13 h. 50 min.	28 h.	55 h. 40 min.	110 h.	224 h.
256 kbps	71 h. 05 min.	4 h. 20 min.	8 h. 50 min.	17 h. 20 min.	35 h.	69 h. 40 min.	137 h.	280 h.
128 kbps	142 h.	8 h. 50 min.	17 h. 40 min.	34 h. 50 min.	70 h. 10 min.	139 h.	275 h.	560 h.
mono	284 h.	17 h.	34 h. 10 min.	54 h. 50 min.	136 h.	276 h.	562 h.	1120 h.

■ **WMA format:**

Recording mode	Built-in flash memory (8 GB)	SD card						
		512 MB	1 GB	2 GB	4 GB	8 GB	16 GB	32 GB
160 kbps	111 h.	6 h. 50 min.	13 h. 50 min.	27 h. 10 min.	54 h. 50 min.	109 h.	215 h.	438 h.
128 kbps	139 h.	8 h. 30 min.	17 h. 20 min.	34 h.	68 h. 40 min.	136 h.	269 h.	547 h.
64 kbps	278 h.	17 h. 20 min.	34 h. 50 min.	68 h. 10 min.	137 h.	272 h.	538 h.	1095 h.
mono	556 h.	33 h. 20 min.	66 h. 55 min.	107 h.	266 h.	539 h.	1098 h.	2189 h.

Notes

- The above values are strictly rough guides.
- Variations in the available recording time will arise as there may be differences in the available memory depending on the card.
- Caution is required, since the differences in the available recording time will increase when the bit count and bit rate are low.
- Available recording time may be shorter if many short recordings are made (The displayed available recording time and recorded time are approximate indications).
- The maximum capacity for a single file is limited to approx. 4 GB for WMA and MP3, and approx. 2 GB for Linear PCM format (WAV).
- For WMA format files, the file length for a single file is limited to a maximum length of approx. 26 hours and 40 minutes. For this reason, it will differ from the continuous recording time for a single file.

Guide to battery life

■ Alkaline batteries:

Recording mode		Built-in stereo microphone (During recording mode)	Built-in stereo speakers (During playback mode)
Linear PCM format	96 kHz 24 bit	13 h. 30 min.	29 h.
	44.1 kHz 16 bit	23 h.	52 h.

■ Ni-MH Rechargeable batteries

Recording mode		Built-in stereo microphone (During recording mode)	Built-in stereo speakers (During playback mode)
Linear PCM format	96 kHz 24 bit	13 h.	24 h.
	44.1 kHz 16 bit	22 h. 30 min.	42 h.

Notes

- The above values are strictly rough guides.
- Battery life is measured by Olympus. It varies greatly according to the type of batteries used and the conditions of use.

Specifications and design are subject to change without notice.

Memo

OLYMPUS®

OLYMPUS IMAGING CORP.

Shinjuku Monolith, 3-1 Nishi-Shinjuku 2-chome, Shinjuku-ku,
Tokyo, 163-0914, Japan. Tel. +81 (0)3-3340-2111
<http://www.olympus.com>

奥林巴斯(上海)映像销售有限公司

上海市徐汇区淮海中路1010号 嘉华中心 1002-1003
电话: 021-5170-6300 传真: 021-5170-6306 邮编: 200031

奥林巴斯(上海)映像销售有限公司北京分公司

北京市朝阳区新源南路1-3号 平安国际金融中心 A座8F
电话: 010-5819-9199 传真: 010-5976-1360 邮编: 100027

奥林巴斯(上海)映像销售有限公司广州分公司

广州市环市东路403号广州国际电子大厦 1650-1608室
电话: 020-6122-7111 传真: 020-6122-7120 邮编: 510095
<http://www.olympus.com>