



感谢阁下选用Sony IC录音机！

您可使用快速入门指南获取有关IC录音机的基本操作说明。请仔细阅读本指南。希望新的Sony IC录音机能为阁下带来快乐。

使用产品前请仔细阅读本使用说明书，并请妥善保管。

检查附件。

- IC录音机 (1)
- 立体声耳机 (1)
- USB连接辅助电缆 (1)
- 携带袋 (1) (仅限ICD-UX533/UX533F/UX534F)
- NH-AAA (AAA尺寸) 可充电电池 (1) (仅限ICD-UX533/UX533F/UX534F)
- LR03 (AAA型) 碱性电池 (1) (仅限ICD-UX532)
- 帮助指南 (存储在内置存储器中的HTML文件, 您可方便地将其复制到您的电脑。)

选购附件

- USB AC适配器AC-UD10

■注
取决于国家或地区, 可能没有某些机型或选购附件。

部件和控制按钮

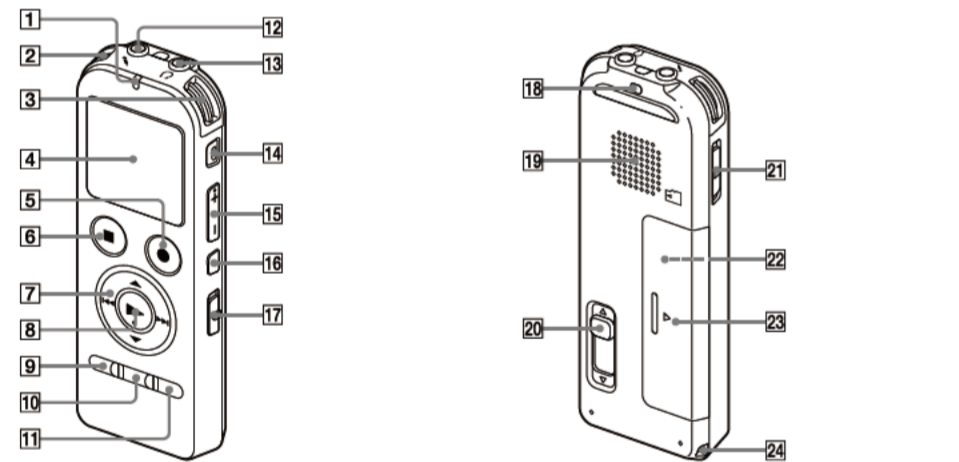

- 1 操作指示灯
- 2 内置话筒 (立体声) (左)
- 3 内置话筒 (立体声) (右)
- 4 显示窗口
- 5 ●REC/PAUSE (录音/暂停) 按钮
- 6 ■STOP按钮
- 7 控制按钮 (▲, ▼, ◀, ▶) (回放/快退, ▶▶ (提示/快进))
- 8 ▶ (播放/确认) 按钮*
- 9 MENU按钮 (仅限ICD-UX532/UX533) MENU/FM按钮 (仅限ICD-UX533F/UX534F)
- 10 FOLDER按钮
- 11 T-MARK (曲目标记) 按钮
- 12 (话筒) 插孔*
- 13 (耳机) 插孔
- 14 ERASE按钮
- 15 VOL-/+(音量-/+) 按钮*
- 16 A-B (重复A-B) 按钮
- 17 DPC (SPEED CTRL) 开关
- 18 腕带安装孔 (不附带腕带。)
- 19 扬声器
- 20 USB DIRECT滑杆
- 21 HOLD•POWER开关
- 22 microSD卡槽 (卡槽位于电池仓中。)
- 23 电池仓
- 24 腕带安装孔 (不附带腕带。)

* 这些按钮及插孔均设有触点。可将其用作操作的参考点, 或用以识别各个端口。

让我们来试用您的新IC录音机

1. 打开电源。

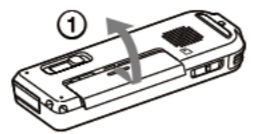

① 滑动并提起电池仓盖, 然后按正确极性插入一节电池。

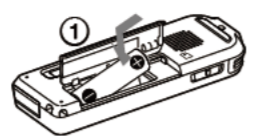

② 打开电源。朝“POWER”方向滑动并按住HOLD•POWER开关, 直到出现窗口显示为止。

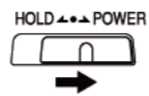

若要关闭电源, 朝“POWER”方向滑动并按住HOLD•POWER开关, 直到显示“关机”动画为止。

防止误操作 (HOLD)

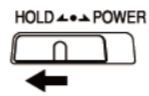

若要释放IC录音机的HOLD状态, 请朝中心位置滑动HOLD•POWER开关。

2. 设置日期和时间。

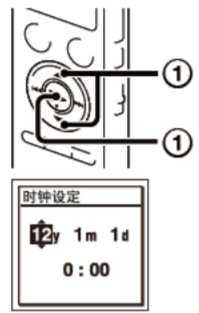

当您首次插入电池, 或在IC录音机超过1分钟没装电池的情况下插入电池时, 则会出现“请设置日期时间”动画, 然后年份部分开始闪烁。

① 按▲或▼设置年份 (年份的最后两位数字), 然后按▶ (播放/确认)。重复该步骤, 依次设置月份、日期、小时和分钟。设置分钟并按▶ (播放/确认) 时, 时钟将反映设置状况。

3. 选择菜单语言。

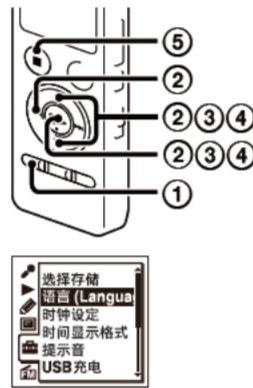

- ① 按MENU (仅限ICD-UX532/UX533) 或MENU/FM (仅限ICD-UX533F/UX534F)。
- ② 按◀, 按▲或▼选择, 然后按▶ (播放/确认)。
- ③ 按▲或▼选择“语言(Language)”, 然后按▶ (播放/确认)。
- ④ 按▲或▼选择要在显示窗口中使用的语言, 然后按▶ (播放/确认)。可以选择以下语言: 简体中文、English (英文)
- ⑤ 按■STOP。

(仅在ICD-UX533F/UX534F上显示选项卡。)

4. 录音。

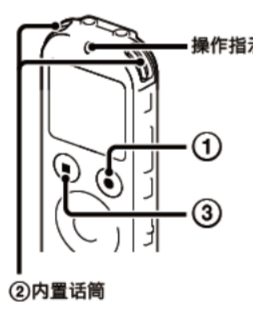

使用IC录音机之前, 务必朝中心位置滑动HOLD•POWER开关以释放HOLD状态。

- ① 按●REC/PAUSE。录音开始, 操作指示灯呈红色亮起。您可以按●REC/PAUSE暂停录音。再次按●REC/PAUSE可重新开始录音。
- ② 放置IC录音机时, 应将内置话筒正对所要录制的声源方向。
- ③ 按■STOP停止录音。屏幕将显示“正在访问...”动画, 并且录音停止。

5. 聆听。

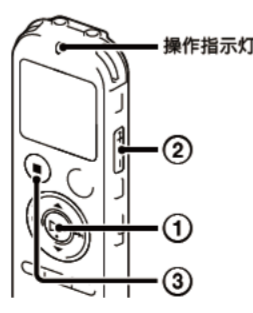

- ① 按▶ (播放/确认)。播放开始, 操作指示灯呈绿色亮起。
- ② 按VOL-/+(音量-/+)调整音量。
- ③ 按■STOP停止播放。

6. 删除。

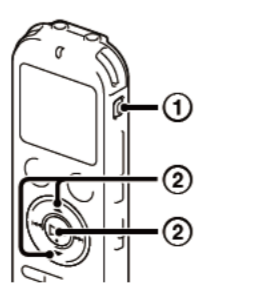

- 文件一旦删除, 则将无法恢复。
- ① 按ERASE。显示“确定删除?”并且播放所要删除的文件以确认。
- ② 使用▲或▼选择“执行”, 然后按▶ (播放/确认)。在删除所选文件的同时, 显示“正在删除...”。

与电脑组合使用

在您的电脑上安装帮助指南

通过从IC录音机的内置存储器安装帮助指南到您的电脑, 在发生问题时您可搜索详细的操作和可能的解决方法。

- ① 滑动IC录音机背面上的USB DIRECT滑杆, 将USB接口插入正在运行的电脑的USB端口。
- ② 在Windows中: 单击 [计算机] (或 [我的电脑]), 然后双击 [IC RECORDER] → [FOR WINDOWS]。在Mac中: 在桌面上双击 [IC RECORDER]。
- ③ 安装帮助指南。在Windows中: 双击 [Help_Guide_Installer] (或 [Help_Guide_Installer.exe])。在Mac中: 双击 [Help_Guide_Installer_for_mac.app]。按照屏幕上出现的指示继续安装。
- ④ 安装完成之后, 在Windows桌面上双击 [Help_Guide_icdu53_cn.htm] (Mac上是在Finder中)。将显示帮助指南。您也可在以下Sony IC录音机用户支持主页上查阅帮助指南: <http://rd1.sony.net/help/icdu53/cn/>

将文件从IC录音机复制到电脑

可以将IC录音机的文件和文件夹复制到电脑上进行保存。

- ① 将IC录音机连接到电脑上。
- ② 将要传输的文件或文件夹复制到电脑上。将要复制的文件或文件夹从“IC RECORDER”或“MEMORY CARD”拖放到电脑的本地磁盘上。

复制文件或文件夹 (拖动)

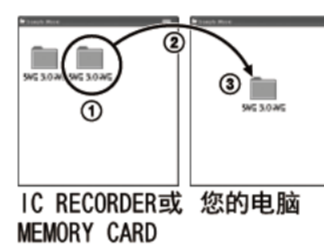

- ① 单击并按住,
- ② 拖动,
- ③ 然后放下。

- ③ 将IC录音机从电脑上断开。

安装Sound Organizer

在电脑上安装Sound Organizer。

■注
Sound Organizer仅兼容Windows计算机。它不兼容Mac。

安装Sound Organizer时, 需用具有管理员权限的帐户登录。

- ① 滑动IC录音机背面上的USB DIRECT滑杆, 将USB接口插入正在运行的电脑的USB端口。如果无法将IC录音机直接连接到电脑, 请使用附带的USB连接辅助电缆。

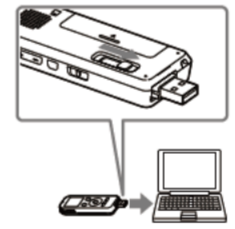

- ② 确认IC录音机已被正确识别。将IC录音机连接到电脑时, IC录音机的显示窗口将显示“正在连接”。
- ③ 进到 [开始] 菜单, 单击 [计算机] (或 [我的电脑]), 然后双击 [IC RECORDER] → [FOR WINDOWS]。
- ④ 双击 [SoundOrganizerInstaller_V130] (或 [SoundOrganizerInstaller_V130.exe])。按照屏幕上出现的指示进行操作。
- ⑤ 确认接受许可协议的条款, 选择 [I accept the terms in the license agreement], 然后单击 [Next]。
- ⑥ 出现 [Setup Type] 窗口时, 选择 [Standard] 或 [Custom], 然后单击 [Next]。选择 [Custom] 时, 按照画面上的指示进行操作并进行安装设置。
- ⑦ 出现 [Ready to Install the Program] 窗口时, 单击 [Install]。开始安装。
- ⑧ 出现 [Sound Organizer has been installed successfully.] 窗口时, 复选 [Launch Sound Organizer Now], 然后单击 [Finish]。

■注
Sound Organizer安装完成后, 可能需要重新启动电脑。

其他功能

录音、播放和编辑的这些其他功能的详情包括在帮助指南中。

- 场景选择
- 录音滤波器
- 消除噪音
- T-MARK (曲目标记)
- DPC (Digital Pitch Control)
- A-B重复
- VOR (Voice Operated Recording)
- 声音效果
- 简易搜索
- 分割 (Divide)
- FM收音机 (仅限ICD-UX533F/UX534F)
- Sound Organizer编辑软件

注意事项

电源
本机只能使用1.2 V或1.5 V DC操作。使用一节NH-AAA可充电电池或一节LR03 (AAA尺寸) 碱性电池。

安全
驾车、骑车或操作任何机动车时请勿操作本机。

操作管理
• 请勿将本机靠近热源或放置于阳光直射、灰尘很多或有机械振动的地方。

• 若有任何固体或液体落入本机, 在进一步操作前, 请取出电池并请有资格的人员进行检查。

如果对本机有任何疑问或问题, 请向最近的Sony经销商咨询。

制造商: 索尼 (中国) 有限公司

地址: 北京市朝阳区太阳宫中路12号楼冠城大厦701

产地: 广东省东莞市

产品标准: 0/CYSNCO007

出版日期: 2012年9月

警告

请勿将电池 (已安装的电池组或电池) 长时间暴露于例如阳光, 火等极热的地方。

USB AC适配器: AC-UD10

额定电流: 1500 mA

也可以连接适用本型号的Sony USB充电交流电源适配器 (另购) 对电池进行充电。

注意

如果使用不正确的电池类型更换电池有爆炸的危险。请按照规定处理使用过的电池。

容量 (可用容量*)

- ICD-UX532: 2 GB (约1.80 GB = 1,932,735,283字节)
- ICD-UX533/UX533F: 4 GB (约3.60 GB = 3,865,470,566字节)
- ICD-UX534F: 8 GB (约7.20 GB = 7,730,941,132字节)
- *少量内置存储被用于文件管理, 因而不可用于用户存储。

产品中有毒有害物质或元素的名称及含量



(○: 不含有, ×: 含有)

部件名称	有毒有害物质或元素					
	铅 (Pb)	汞 (Hg)	镉 (Cd)	六价铬 (Cr (VI))	多溴联苯 (PBB)	多溴二苯醚 (PBDE)
内置线路板	×	○	○	○	○	○
外壳	×	○	○	○	○	○
显示板	○	○	○	○	○	○
扬声器	×	○	○	○	○	○
附件	○	○	○	○	○	○

○: 表示该有毒有害物质在该部件所有均质材料中的含量均在SJ/T11363-2006标准规定的限量要求以下。

×: 表示该有毒有害物质至少在该部件的某一均质材料中的含量超出SJ/T11363-2006标准规定的限量要求。



GB
CS

Let's try out your new IC recorder

1. Power on.

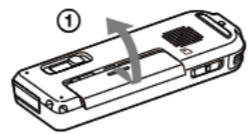

- Slide and lift the battery compartment lid, then insert a battery with the correct polarity.
- Turn the power on. Slide and hold the HOLD+POWER switch in the direction of "POWER" until the window display appears.

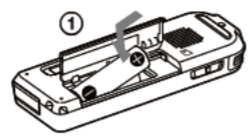

To turn the power off, slide and hold the HOLD+POWER switch in the direction of "POWER" until "关机" animation is displayed.

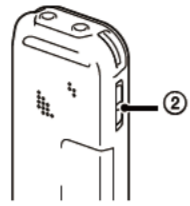

To prevent unintentional operations (HOLD)



To release the IC recorder from the HOLD status, slide the HOLD+POWER switch towards the center.

2. Set the date and time.

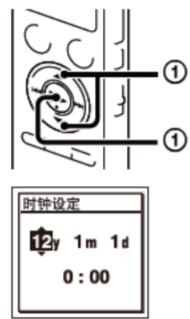

When you insert a battery for the first time, or after the IC recorder has been without a battery for more than 1 minute, the "请设置日期时间" animation appears, and then the year section begins to flash.

- Press ▲ or ▼ to set the year (the last two digits of the year), and then press ►(play/enter). Repeat this procedure to set month, day, hour, and minute in sequence. When you set the minute and press ►(play/enter), the clock reflects the setting.

3. Select the menu language.

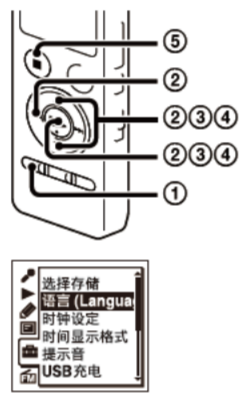

- Press MENU (ICD-UX532/UX533 only) or MENU/FM (ICD-UX533F/UX534F only).
- Press ◀, press ▲ or ▼ to select 语言, and then press ►(play/enter).
- Press ▲ or ▼ to select "语言(Language)," and then press ►(play/enter).
- Press ▲ or ▼ to select the language that you want to use in the display window, and then press ►(play/enter). You can select the following languages: 简体中文 (Chinese), English
- Press ■STOP.

(The 语言 tab is displayed only on the ICD-UX533F/UX534F.)

4. Record.

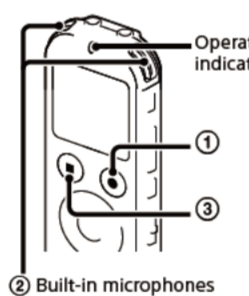

- Before you start using the IC recorder, make sure that you slide the HOLD+POWER switch towards the center to release the HOLD status.
- Press ●REC/PAUSE. Recording starts and the operation indicator lights in red. You can pause recording by pressing ●REC/PAUSE. Press ●REC/PAUSE again to restart recording.
 - Place the IC recorder so that the built-in microphones face the direction of the source to be recorded.
 - Press ■STOP to stop recording. The "正在访问..." animation appears and the recording stops.

5. Listen.

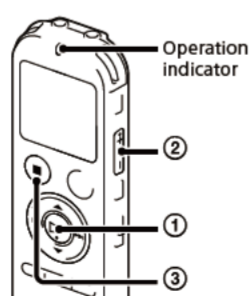

- Press ►(play/enter). Playback starts and the operation indicator lights in green.
- Adjust the volume by pressing VOL -/+.
- Press ■STOP to stop playback.

6. Erase.

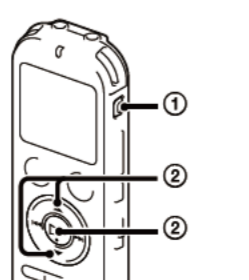

- Once a file is erased, you cannot restore it.
- Press ERASE. "确定删除?" is displayed and the file to be erased is played back for confirmation.
 - Select "执行" using ▲ or ▼, and then press ►(play/enter). "正在删除..." is displayed while the selected file is being erased.

Welcome to your new Sony IC recorder!

This is the Quick Start Guide, which provides you with instructions on the basic operations of the IC recorder. Please read it carefully. We hope you enjoy using your new Sony IC recorder.

Check the supplied items.

- IC Recorder (1)
- Stereo headphones (1)
- USB connection support cable (1)
- Carrying pouch(1) (ICD-UX533/UX533F/UX534F only)
- NH-AAA (size AAA) rechargeable battery (1) (ICD-UX533/UX533F/UX534F only)
- LR03 (size AAA) alkaline battery (1) (ICD-UX532 only)
- Help Guide (HTML file stored in the built-in memory so it can easily be copied to your computer.)

Optional accessories

- USB AC adaptor AC-UD10

Note
Depending on the country or region, some of the models or optional accessories are not available.

Parts and controls

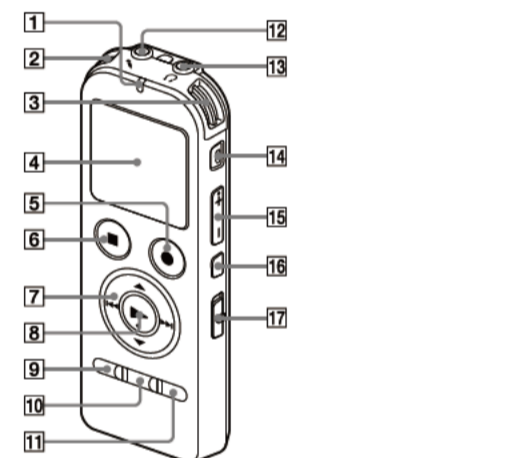

- Operation indicator
- Built-in microphones (stereo) (L)
- Built-in microphones (stereo) (R)
- Display window
- REC/PAUSE (record/pause) button
- STOP button
- Control button (▲, ▼, ◀, ▶ (review/fast backward), ▶ (cue/fast forward))
- (play/enter) button*
- MENU button (ICD-UX532/UX533 only) MENU/FM button (ICD-UX533F/UX534F only)
- FOLDER button
- T-MARK (track mark) button
- (microphone) jack*
- (headphones) jack
- ERASE button
- VOL -/+ (volume -/+) button*
- ↔ A-B (repeat A-B) button
- DPC (SPEED CTRL) switch

* These buttons and the jack have a tactile dot. Use it as a reference point for operations, or to identify each terminal.

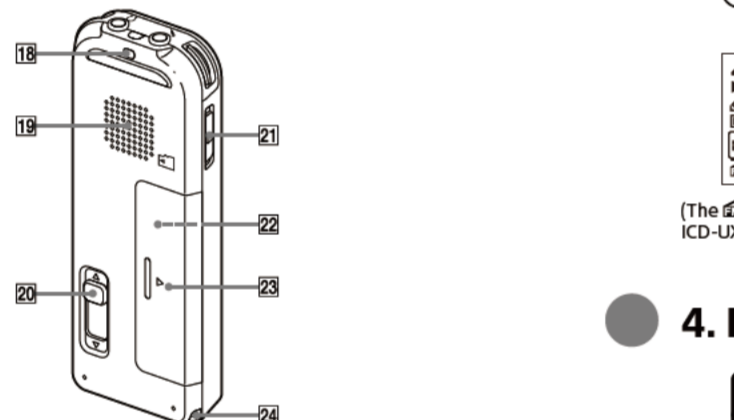

- Strap hole (A strap is not supplied.)
- Speaker
- USB DIRECT slide lever
- HOLD+POWER switch
- microSD card slot (The card slot is in the battery compartment.)
- Battery compartment
- Strap hole (A strap is not supplied.)

Utilizing Your Computer

Installing the help guide on your computer

By installing the help guide on your computer from the built-in memory of the IC recorder, you can search for detailed operations and possible solutions when a problem occurs.

- Slide the USB DIRECT slide lever on the back of the IC recorder, and insert the USB connector into the USB port of a running computer.
- In Windows: Click [Computer] (or [My Computer]), then double-click [IC RECORDER] → [FOR WINDOWS].
In Mac: Double-click [IC RECORDER] on the desktop.
- Install the help guide.
In Windows: Double-click [Help_Guide_Installer] (or [Help_Guide_Installer.exe]).
In Mac: Double-click [Help_Guide_Installer_for_mac.app].
Follow the instructions that appear on the screen to proceed with installation.
- After the installation completes, double-click the [Help_Guide_icdu53_cn.htm] icon in the desktop for Windows (or in Finder for Mac). The help guide is displayed. You can also view the help guide on the following Sony IC Recorder customer support home page:
<http://rd1.sony.net/help/icd/u53/cn/>

Copying files from the IC recorder to your computer

You can copy the files and folders from the IC recorder to your computer to store them.

- Connect the IC recorder to your computer.
- Copy files or folders you want to transfer to your computer. Drag and drop the files or folders you want to copy from "IC RECORDER" or "MEMORY CARD" to the local disk on your computer.

To copy a file or folder (Drag and drop)

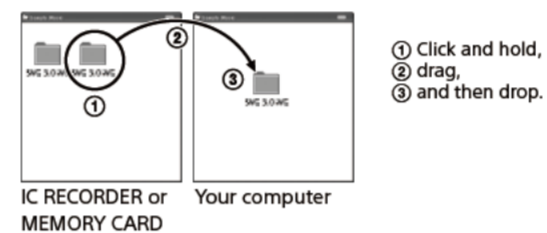

- Disconnect the IC recorder from your computer.

Installing Sound Organizer

Install Sound Organizer on your computer.

Note
Sound Organizer is compatible with the Windows PC only. It is not compatible with Mac.

When installing Sound Organizer, log in to an account with administrator privileges.

- Slide the USB DIRECT slide lever on the back of the IC recorder, and insert the USB connector into the USB port of a running computer. If the IC recorder cannot be connected to a computer directly, use the supplied USB connection support cable.

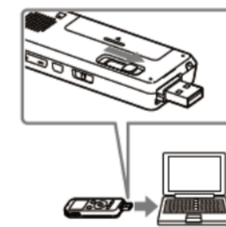

- Make sure the IC recorder has been recognized properly. While the IC recorder is connected to the computer, "正在连接" is displayed in the display window of the IC recorder.
- Go to the [Start] menu, click [Computer] (or [My Computer]), and then double-click [IC RECORDER] → [FOR WINDOWS].
- Double-click [SoundOrganizerInstaller_V130] (or [SoundOrganizerInstaller_V130.exe]). Follow the instructions that appear on the screen.
- Make sure that you accept the terms of the license agreement, select [I accept the terms in the license agreement], and then click [Next].
- When the [Setup Type] window appears, select [Standard] or [Custom], and then click [Next]. Follow the instructions on the screen and set the installation settings when you select [Custom].
- When the [Ready to Install the Program] window appears, click [Install]. The installation starts.
- When the [Sound Organizer has been installed successfully.] window appears, check [Launch Sound Organizer Now], and then click [Finish].

Note
You may need to restart your computer after installing Sound Organizer.

Additional features

Details of these additional features for recording, playback, and editing are included in the help guide.

- Scene Selection
- 录音滤波器(Recording Filter)
- 消除噪音(Noise Cut)
- T-MARK (Track mark)
- DPC (Digital Pitch Control)
- A-B Repeat
- VOR (Voice Operated Recording)
- 声音效果(Sound Effect)
- 简易搜索(Easy Search)
- Divide
- FM Radio (for ICD-UX533F/UX534F only)
- Sound Organizer editing software

Precautions

On power
Operate the unit only on 1.2 V or 1.5 V DC. Use one NH-AAA rechargeable battery or one LR03 (size AAA) alkaline battery.

On safety
Do not operate the unit while driving, cycling or operating any motorized vehicle.

On handling
Do not leave the unit in a location near heat sources, or in a place subject to direct sunlight, excessive dust or mechanical shock.

Should any solid object or liquid fall into the unit, remove the battery and have the unit checked by qualified personnel before operating it any further.

If you have any questions or problems concerning your unit, please consult your nearest Sony dealer.

WARNING

Do not expose the batteries (battery pack or batteries installed) to excessive heat such as sunshine, fire or the like for a long time.

CAUTION

Risk of explosion if battery is replaced by an incorrect type. Dispose of used batteries according to the instructions.

Capacity (User available capacity*)

ICD-UX532 : 2 GB (approx. 1.80 GB = 1,932,735,283 Byte)

ICD-UX533/UX533F : 4 GB (approx. 3.60 GB = 3,865,470,566 Byte)

ICD-UX534F : 8 GB (approx. 7.20 GB = 7,730,941,132 Byte)

* A small amount of the internal memory is used for file management and therefore not available for user storage.

For the customers in China
RATED CURRENT CONSUMPTION: 1500 mA

AC adaptor: AC-UD10