

# USER GUIDE

hTC Rezound™



# Contents

---

## Getting started

---

Inside the box	14
HTC Rezound with Beats Audio	15
Back cover	18
SIM card	20
Storage card	22
Battery	24
Switching the power on or off	27
Finger gestures	28
Setting up HTC Rezound with Beats Audio for the first time	29
Ways of getting contacts into HTC Rezound with Beats Audio	30
Home screen	32
Plugging in your Beats headphones	34

---

## Basics

---

Adjusting the volume	35
Sleep mode	37
Status and notifications	39
Where apps, data, and files are stored	47
Connecting your phone to a computer	48

Copying files to or from the phone storage or storage card	49
Copying text, looking up information, and sharing	50
Printing	52

---

## Personalizing

---

Making HTC Rezound with Beats Audio truly yours	53
Personalizing HTC Rezound with Beats Audio with scenes	53
Changing your wallpaper	55
Applying a new skin	56
Personalizing your Home screen with widgets	57
Adding icons and other shortcuts on your Home screen	59
Adding folders on your Home screen	60
Rearranging or removing widgets and icons on your Home screen	61
Rearranging the Home screen	62
Using sound sets	64
Rearranging or hiding application tabs	66
Customizing the lock screen style	68

---

## Phone calls

---

Different ways of making calls	69
Making a call on the Phone dialer screen	69
Using Speed dial	70
Calling a phone number in a text message	71

Calling a phone number in an email	72
Calling a phone number in a Calendar event	72
Making an emergency call	72
Receiving calls	73
What can I do during a call	76
Using Assisted dialing	78
Internet calls	80
Using Call history	82
Call services	84
Turning Airplane mode on or off	85
Visual Voice Mail	86

---

## Messages

---

Opening Messages	88
Sending a text message (SMS)	89
Sending a multimedia message (MMS)	90
Resuming a draft message	93
Viewing and replying to a message	94
Forwarding a message	96
Viewing and saving an attachment from a multimedia message	97
Push messages	98
Managing message conversations	99
Backing up your text messages to the storage card	101
Setting message options	102

---

## Search and Web browser

---

Searching HTC Rezound with Beats Audio and the Web	105
Using the web browser	107
Downloading from the Web	110
Viewing bookmarks and previously visited pages	112
Setting browser options	114

---

## Camera

---

Camera basics	116
Taking a photo	118
Recording video	120
Adding effects	121
After capturing	121
Camera scenes	122
Taking a panoramic photo	122
Taking continuous camera shots	123
Taking a high dynamic range (HDR) photo	123
Changing camera settings	124

---

## Photos, videos, and music

---

Gallery	127
Music	140
Connected Media	148

---

## HTC services

---

HTC Watch	151
-----------	-----

---

---

## Accounts and sync

---

About online accounts	158
Synchronizing with a Google Account	159
Adding a social network account	160
Managing your online accounts	161

---

---

## People

---

About the People app	164
Your contacts list	166
Setting up your profile	167
Importing contacts from your SIM card	169
Adding a new contact	169
Searching for contacts	170
Importing a contact from an Exchange ActiveSync account	171
Merging contact information	172
Backing up your contacts to the storage card	174
Contact information and conversations	175
Sending contact information as a vCard	177
Contact groups	178
Adding People widgets	182

---

## Social

---

Facebook for HTC Sense	185
Using Facebook chat	187
Twitter for HTC Sense	188
Using Friend Stream	188
Enjoying Facebook in Friend Stream	191
Tweeting in Friend Stream	193
Chatting in Google Talk	196
Using Facebook chat	200

---

## Email

---

Gmail	202
Mail	205

---

## Calendar

---

About Calendar	221
Creating an event	222
Changing Calendar views	223
Managing Calendar events	225
Accepting or declining a meeting invitation	227
Dismissing or snoozing event reminders	228
Showing or hiding calendars	228
Changing Calendar settings	229

About the Calendar widget	230
---------------------------	-----

---

## Maps and location

---

Location settings	231
Footprints	232
Google Maps	234
VZ Navigator	240

---

## Android Market and other apps

---

Finding and installing apps from Android Market	243
Using the Clock	246
Checking Weather	251
Reading news feeds	254
Watching videos on YouTube	257
Sharing games and apps	259

---

## Productivity

---

Completing tasks	261
Scanning codes	267
Working on documents	271
Recording your voice	272



---

## HTC Sync

---

About HTC Sync	274
Installing HTC Sync	275
Setting up HTC Sync to recognize HTC Rezound with Beats Audio	275
Getting to know the workspace	276
Setting up synchronization	277
Synchronizing HTC Rezound with Beats Audio	283
Installing an app from your computer to HTC Rezound with Beats Audio	283
Synchronizing another device with your computer	284
Downloading the latest HTC Sync upgrade	285

---

## Keyboard

---

Using the onscreen keyboard	286
Entering words with predictive text	289
Entering text by speaking	292
Entering text by tracing	293
Editing text	294
Adjusting input settings	295

---

## Internet connections

---

Data connection	297
Wi-Fi	298

Connecting to a virtual private network (VPN)	302
Using HTC Rezound with Beats Audio as a modem (USB tethering)	304
Connecting HTC Rezound with Beats Audio to the Internet through a computer (Internet Pass-through)	305
Using HTC Rezound with Beats Audio as a wireless router	306

---

## Bluetooth

---

Bluetooth basics	307
Connecting a Bluetooth headset or car kit	308
Disconnecting or unpairing from a Bluetooth device	310
Sending information using Bluetooth	311
Receiving information using Bluetooth	314

---

## Security

---

Protecting your SIM card with a PIN	316
Protecting HTC Rezound with Beats Audio with a screen lock pattern, PIN, or password	317
Encrypting data on HTC Rezound with Beats Audio	319
Backing up your contacts	320

---

## Settings

---

Settings on HTC Rezound with Beats Audio	322
Changing display settings	325
Changing sound settings	328

Changing the language	330
Optimizing battery life	330
Managing memory	332
Checking information about HTC Rezound with Beats Audio	335

---

## Update and reset

---

Software updates	337
Restarting HTC Rezound with Beats Audio	338
Resetting HTC Rezound with Beats Audio	339

---

## Trademarks and copyrights

---

---

## Index

---

## IMPORTANT CUSTOMER INFORMATION

Please be advised that many services and applications offered through this unique device are provided by various device, operating system, software and application developers (e.g. Google, Motorola, Microsoft, Palm, Research In Motion). If you use, link to or download such a service, or an application such as a non-Verizon Wireless location based GPS-type service, chat room, marketplace or social network from this device, you should carefully review the terms of such service or application. If you use any of these non-Verizon Wireless services or applications, personal information you submit may be read, collected, or used by the service or application provider and/or other users of those forums.

Verizon Wireless is not responsible for your use of those applications or information you choose to submit or share with others. Specific terms and conditions, terms of use, and privacy policies apply to those applications and services. Please review carefully any and all terms and conditions applicable to those applications and services including those related to any location-based services for any particular privacy policies, risks or waivers.

Your Verizon Wireless Customer Agreement Terms and Conditions and certain other specifically identified terms govern your use of any Verizon Wireless products and services.

## Conventions used in this guide

In this user guide, we use the following symbols to indicate useful and important information:



This is a note. A note often gives additional information, such as what happens when you choose to do or not to do a certain action. A note also provides information that may only be applicable to some situations.



This is a tip. A tip gives you an alternative way to do a particular step or procedure, or lets you know of an option that you may find helpful.



This indicates important information that you need in order to accomplish a certain task or to get a feature to work properly.



This provides safety precaution information, that is, information that you need to be careful about to prevent potential problems.

# Getting started

## Inside the box

You will find the following inside the box:

- HTC Rezound with Beats Audio™
- Beats™ headphones (pouch and buds included)
- Battery
- microSD™ card (preinstalled)
- USB cable
- Power adapter
- Quick start guide
- RF brochure
- Product Safety and Warranty Information brochure
- Important Consumer Information brochure

## HTC Rezound with Beats Audio

---

### Front panel

---

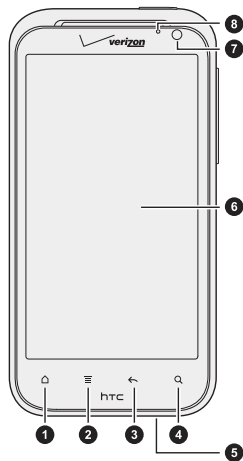

1. HOME
2. MENU
3. BACK
4. SEARCH
5. Microphone
6. Touch screen
7. Front camera
8. Notification LED
9. Earpiece

---

### Top panel

---

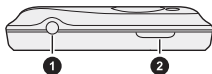

1. 3.5mm headset jack
2. POWER/LOCK

## Left and right panels

---

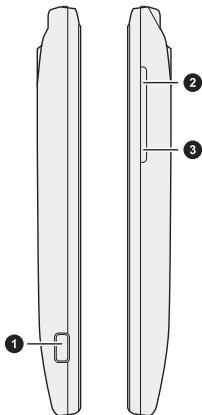

1. USB connector
2. VOLUME UP
3. VOLUME DOWN



## Back panel

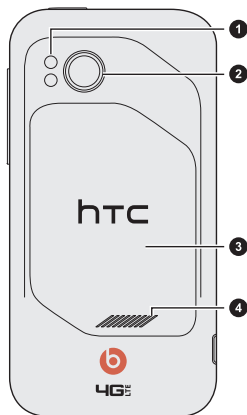

1. Dual LED flash
2. 8 megapixel camera
3. Back cover
4. Speaker

## Back cover

---

### Removing the back cover

---

Remove the back cover to access the battery compartment, SIM card slot, and storage card slot.



Make sure to switch off HTC Rezound with Beats Audio before removing the back cover.

1. Securely hold HTC Rezound with Beats Audio facing down.
2. Lift the back cover from the notch with your finger, and then remove the back cover.



---

## Replacing the back cover

---

⚑ The phone's antennas are placed underneath the back cover. To get the best signal for calls, data connection, or GPS navigation, be sure to secure the back cover tightly to the phone.

1. Align the back cover onto the top panel of HTC Rezound with Beats Audio.

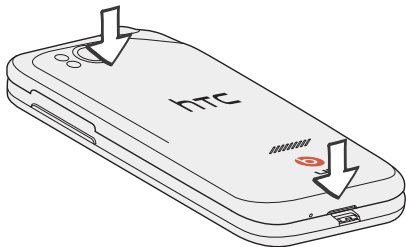

2. Press the sides of the back cover down to lock it into place. You'll hear clicks when the small tabs underneath the back cover are locked in place.

## SIM card

The SIM card contains your phone number, service details, and memory for storing phonebook contacts and/or text messages.

---

### Inserting the SIM card

---

1. Take the back cover off.
2. Remove the battery.
3. With the SIM card's gold contacts facing down and its cut-off corner facing the red SIM card tab, insert the SIM card all the way into the SIM card slot.

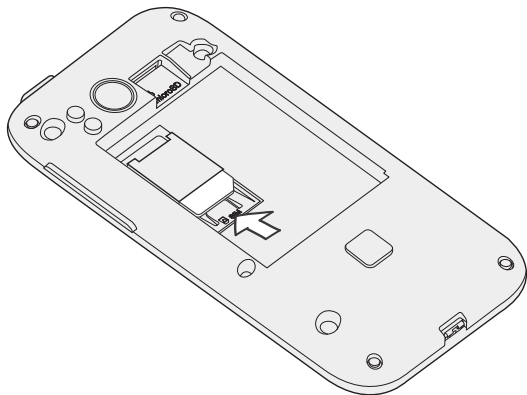

---

## Removing the SIM card

---

**F** Make sure to switch off HTC Rezound with Beats Audio before removing your SIM card.

1. Take the back cover off.
2. Remove the battery.
3. Press and hold the SIM card tab.

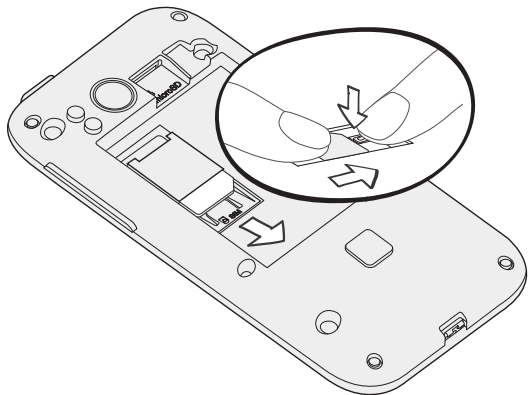

4. Slide the SIM card out from the SIM card slot.

## Storage card

Use the storage card to store your photos, videos, and music. You'll find the storage card already inserted in HTC Rezound with Beats Audio.

---

### Inserting the storage card

---

1. Take the back cover off.
2. Remove the battery.
3. Insert the microSD card into the storage card slot with its gold contacts facing down and push it all the way into the slot.

---

### Removing the storage card

---

**F** If HTC Rezound with Beats Audio is on, you must first "unmount" the storage card before removing it to prevent corrupting or damaging the files in the storage card.

1. Take the back cover off.
2. Remove the battery.

3. Slide the storage card out from its slot.

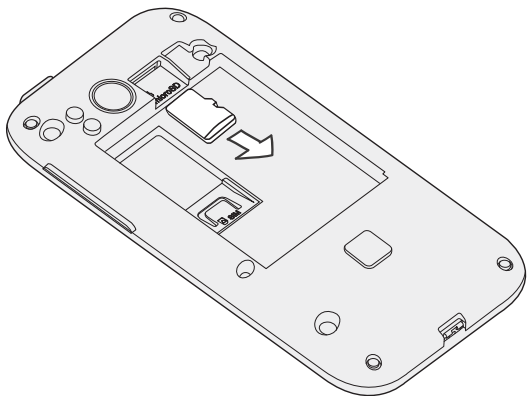

---

### Unmounting the storage card

---

When you need to remove the storage card while HTC ReZound with Beats Audio is on, unmount the storage card first to prevent corrupting or damaging the files in the storage card.

1. From the Home screen, press MENU , and then tap **Settings**.
2. Tap **SD & phone storage** > **Unmount SD card**.

## Battery

HTC Rezound with Beats Audio uses a rechargeable battery. How long the battery can last before it needs recharging depends on how you use HTC Rezound with Beats Audio. The features and accessories you use can affect battery life. For example, leaving your Bluetooth® connection always on uses more power. Long phone calls or frequent web browsing use up a lot of battery power. Also, consider your location: poor signal strength and extreme temperature make the battery work harder.

---

### Removing the battery

---

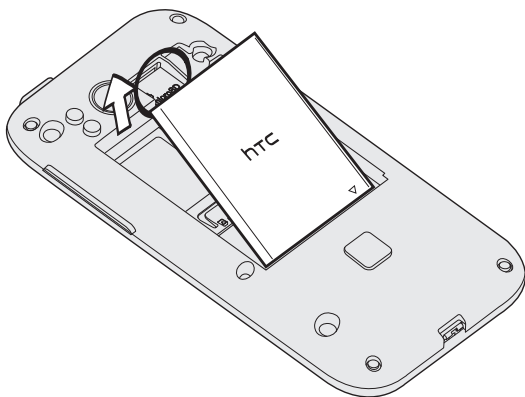

1. Take the back cover off.
2. With your thumb or finger, lift the battery from the battery compartment.



## Inserting the battery

⚠ Please use only original batteries that came in the box or replacements that we recommend.

1. Take the back cover off.
2. Insert the battery (with its exposed copper contacts first) into the battery compartment.

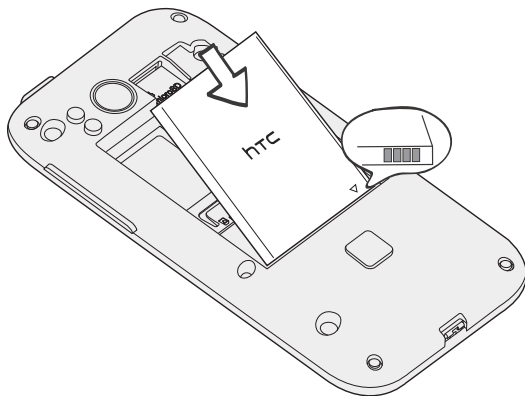

## Charging the battery

Before you turn on and start using HTC Rezound with Beats Audio, it is recommended that you charge the battery.



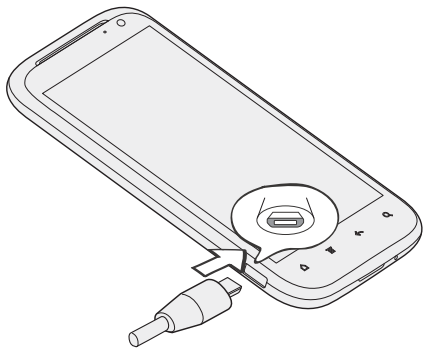

- Only the power adapter and USB cable provided in the box must be used to charge the battery.
- Do not remove the battery from HTC Rezound with Beats Audio while you are charging it using the power or car adapter.

1. Insert the small end of the USB cable into the USB connector.



2. Insert the other end of the USB cable into the power adapter.
3. Plug in the power adapter to an electrical outlet to start charging the battery.

As the battery is being charged, the notification LED shows a solid orange light. The light turns to solid green when the battery is fully charged.

When you charge the battery and HTC Rezound with Beats Audio is on, the charging battery icon  is displayed in the status bar. After the battery has been fully charged, the charging battery icon turns to a full battery icon .



As a safety precaution, the battery stops charging when it overheats.

## Switching the power on or off

---

### Switching the power on

---

Press the POWER/LOCK button. Easy.



When you turn on HTC Rezound with Beats Audio for the first time, you'll need to set it up.

---

### Switching the power off

---

1. If the display is off, press the POWER/LOCK button to turn it back on, then move the ring upward to unlock the screen.
2. Press and hold the POWER/LOCK button for a few seconds.
3. When the Power options menu appears, tap **Power off**.

## Finger gestures

<b>Tap</b>	When you want to type using the keyboard, select items onscreen such as application and settings icons, or press onscreen buttons, simply tap them with your finger.
<b>Press and hold</b>	To open the available options for an item (for example, a contact or link in a web page), simply press and hold the item.
<b>Swipe or slide</b>	To swipe or slide means to quickly drag your finger vertically or horizontally across the screen.
<b>Drag</b>	Press and hold your finger with some pressure before you start to drag. While dragging, do not release your finger until you have reached the target position.
<b>Flick</b>	Flicking the screen is similar to swiping, except that you need to swipe your finger in light, quicker strokes. This finger gesture is always in a vertical direction, such as when flicking the contacts or message list.
<b>Rotate</b>	For most screens, you can automatically change the screen orientation from portrait to landscape by turning HTC Rezound with Beats Audio sideways. When entering text, you can turn HTC Rezound with Beats Audio sideways to bring up a bigger keyboard.
<b>Pinch</b>	In some apps, like Gallery or the web browser, you can “pinch” the screen using two fingers (for example, thumb and index finger) to zoom in or zoom out when viewing a picture or a web page.

## Setting up HTC Rezound with Beats Audio for the first time

When you switch on HTC Rezound with Beats Audio for the first time, you'll be asked to set it up.

Be sure to sign in to your Google® Account so you can use Google apps like Gmail™ and Android Market™. You can also set up your other email accounts, favorite social networks like Facebook®, Twitter™, and more.

Just follow the onscreen instructions and you'll be up and running in no time.



- Some features that need to connect to the Internet such as location-based services and auto-sync of your online accounts use a large amount of data. Don't worry. You can enable or disable them in settings later on.
- To save on data cost, enable the Wi-Fi® Enhanced Connectivity feature so you can seamlessly connect from Verizon Wireless network to an available Wi-Fi network every time you open an app that requires Internet connection. For more information, see [Wi-Fi Enhanced Connectivity](#) on page 300.

## Ways of getting contacts into HTC Rezound with Beats Audio

There are several ways you can add contacts to HTC Rezound with Beats Audio. You can sync HTC Rezound with Beats Audio with contacts from your Google Account, computer, Facebook, and more.

<b>HTC Sync™</b>	Sync the contacts from your old phone to your computer, and then use HTC Sync to sync HTC Rezound with Beats Audio with your computer's Microsoft® Outlook®, Outlook Express or Windows® Contacts.
<b>Gmail</b>	Google contacts are imported to HTC Rezound with Beats Audio after you sign in to your Google Account. You can also create more Google contacts right from HTC Rezound with Beats Audio.
<b>Facebook</b>	Log in to your Facebook account to import your Facebook friends' contact information.
<b>Phone contacts</b>	You can choose to create and store contacts directly in HTC Rezound with Beats Audio or transfer existing ones from your old phone.
<b>SIM card</b>	Copy all your SIM contacts to HTC Rezound with Beats Audio.
<b>Microsoft Exchange ActiveSync®</b>	HTC Rezound with Beats Audio syncs your work contacts from the Microsoft Exchange ActiveSync Server in your workplace.

**Backup  
Assistant**

When you sign up for this service, you can automatically back up and sync contacts with the Backup Assistant server.

## Home screen

Your Home screen is where you make HTC Rezound with Beats Audio your own. It comes with a weather clock widget that shows the time and weather in your current location. You can also add your favorite applications, shortcuts, folders and widgets so they're always just a tap away. To find out how, see [Personalizing](#) on page 53.

---

## Extended Home screen

---

As you start to do more things with HTC Rezound with Beats Audio, you might find that one Home screen is not enough. No problem. You can use up to six extra screens. It should be plenty.



- Slide your finger horizontally to the left or right and you'll discover more space for adding icons, widgets, and more.
- Press HOME  to return to the main Home screen (that is, the center home screen).



---

## Using Leap view

---

- To jump straight to the screen that you want, press HOME  or pinch the screen to show the Leap view. It reveals all seven Home screens as thumbnails. Just tap the one you want and you'll leap right there.
- In Leap view, if there's space to add a new screen, you can tap **Add panel** to do so. An empty Home screen appears and you can start customizing from there.



## Plugging in your Beats headphones

For a richer sound experience, plug in your Beats headphones from HTC. The stylish Beats headphones bring added listening pleasure. With studio quality presets from Beats Audio, your media collection sounds its best. When you play a music track, the Beats icon  shows in the status bar. When you watch a video, Beats Audio also improves the audio quality.

# Basics



## Adjusting the volume

Adjusting the ringer volume changes the volume level of the ringtone, while adjusting the media volume changes the volume level of sound notifications and music or video playback.

---

### Adjusting the ringer volume

---

- Press the VOLUME UP or VOLUME DOWN button to adjust the ringer volume to your desired level. The Ringer volume window appears on the screen to display the volume levels.
- While in the lowest ringer volume level (Silent mode), press VOLUME DOWN once to switch to Vibrate mode. The vibrate mode icon  appears in the status bar.
- While in Vibrate mode, press VOLUME UP once to switch to silent mode. The speaker mute icon  displays in the status bar.

---

## Adjusting the earpiece volume for calls

---

During a call, press the VOLUME UP or VOLUME DOWN button.

---

## Adjusting the media volume

---

When playing music or watching video, press the VOLUME UP or VOLUME DOWN button to adjust the volume. The Media volume window appears on the screen to display the volume level.

---

## Adjusting the volume via settings

---

1. From the Home screen, press MENU , and then tap **Settings > Sound > Volume**.
2. Drag the volume sliders to the left or right to adjust the volume levels of the ringtone, media playback, alarms, and notifications. A sample tone is briefly played with the volume being adjusted as you drag a slider.
3. If you want the same volume for your ringtone and notifications, select **Use incoming call volume for notifications**.
4. When you're done, tap **OK**.

## Sleep mode

Sleep mode saves battery power by putting HTC Rezound with Beats Audio into a low power state while the display is off. It also stops accidental button presses when HTC Rezound with Beats Audio is in your bag. You'll still receive messages and calls though.

---

### Switching to Sleep mode

---

Briefly press the POWER/LOCK button to turn off the display and switch to Sleep mode. HTC Rezound with Beats Audio also automatically goes into Sleep mode when it's idle for a while.

---

### Waking up from Sleep mode

---

To wake HTC Rezound with Beats Audio up manually, press the POWER/LOCK button. You'll need to unlock the screen.



HTC Rezound with Beats Audio automatically wakes up when you have an incoming call.

---



### Unlocking the screen

---

Pull the ring up to unlock the screen.



If you have set up a screen unlock pattern, pin, or password, you will be asked to draw the pattern on the screen or enter the PIN or password before it unlocks.

If you've set an event reminder or an alarm, you can drag  or  to the ring to snooze or dismiss the event or alarm.

---

### Opening an app from the lock screen

---

On the lock screen, drag an app icon to the ring to unlock the screen and directly go to the app.















You can select the app shortcuts you want to appear on the lock screen in **Settings > Personalize > Display tab > Lock screen shortcuts**.















## Status and notifications

### Status icons



Here's what each icon means:

 Signal strength	 Battery is very low (10% or less remaining)
 3G connected	 Silent mode
 3G in use	 Vibrate mode
 4G LTE connected	 Microphone is mute
 4G LTE in use	 Speakerphone is on
 Roaming	 Wired microphone headset connected

 No signal	 Wired headset connected
 No SIM card installed	 Bluetooth is on
 Connected to a Wi-Fi network	 Connected to a Bluetooth device
 Data synchronizing	 Airplane mode
 Network sharing is on	 Location service is on
 Battery is full	 Location service is off
 Battery is charging	 Alarm is set
 Battery is low (20% remaining)	

































## Notification icons

Notification icons on the status bar make it easy for you to keep on top of your messages, calendar events, and alarms.



Here's what each one means:

 New Gmail message	 General notification
 New Microsoft Exchange ActiveSync or POP3/IMAP email	 Call in progress
 Problem with email delivery	 Missed call
 New SMS/MMS	 Call on hold
 Problem with SMS/MMS delivery	 Call forwarding on
 New Google Talk™ instant message	 HTC ReSound with Beats Audio is connected to a computer via USB cable
 New voicemail	 Wi-Fi is on and wireless networks are available

 Upcoming event	 Mobile Hotspot is on
 New updates from your social networks	 Uploading data (animated)
 Matched contacts suggestion	 Downloading data (animated)
 Bluetooth pairing request	 Waiting to upload
 HTC ReSound with Beats Audio software update available	 Downloaded Android Market app installed successfully
 Song is playing	 Update available for an app downloaded from Android Market
 Voice recording is on	 Blank card
 More (not displayed) notifications	 Internal storage is low

---

## Notification LED

---



The notification LED shows a:

- Solid green light when HTC Rezound with Beats Audio is connected to the power adapter or a computer and the battery is fully charged.
- Flashing green light when you have a pending notification.
- Solid orange light when the battery is being charged.
- Flashing orange light when the battery level reaches very low.

## Notifications panel

When you get a new notification, you can open the Notifications panel to see what event notification or new information you've received. The Notifications panel lets you quickly switch between recently-opened apps, and also lets you easily turn on settings such as Wi-Fi and Bluetooth.

To open the Notifications panel, press and hold the status bar, then slide your finger downward.



If you have several notifications, you can scroll down the screen to see them all.



You can also open the Notifications panel on the Home screen by pressing MENU  and then tapping **Notifications**.

## Switching between recently opened apps

On the Notifications panel, you can easily access up to eight apps you just recently opened.

1. Press and hold the status bar, then slide your finger downward to open the Notifications panel.
2. In the Recent apps section, slide your finger left or right to see recently-opened apps.



3. Tap an app to open it.



Press and hold HOME  to view recently used apps.

## Using Quick Settings

The Quick Settings tab lets you easily turn on Wi-Fi, Bluetooth, and more, and also provides a quick shortcut to all HTC Rezound with Beats Audio settings.

1. Press and hold the status bar, then slide your finger downward to open the Notifications panel.
2. Tap the Quick Settings tab.

3. Tap the check box next to an item to turn it off or on.



4. Tap  next to Additional settings to access all HTC Rezound with Beats Audio settings.

### Closing the Notifications panel

Press and hold the bottom bar of the Notifications panel, then slide your finger up the screen. Or just press BACK .

## Where apps, data, and files are stored

HTC Rezound with Beats Audio uses these storage types:

<b>Apps and data storage</b>	<p>Apps are installed to this storage, labeled as <b>Internal storage</b> in your phone settings. It also stores data such as your text messages, contacts you created or synchronized to your phone, account settings, and more.</p> <p>This storage is managed and carefully guarded by your phone since it contains your private information. When you connect your phone to your computer, this storage is not accessible from your computer.</p> <p>Storage contents will be erased when you do a factory reset. Make sure to back up your data before starting a factory reset. Some apps allow you to back up to your storage card, such as People.</p>
<b>File storage</b>	<p>This is another built-in storage, labeled as <b>Phone storage</b> in your phone settings. This is where you can store your files.</p> <p>When you connect your phone to your computer, this storage is accessible and you can copy files between them.</p> <p>When you do a factory reset, you can choose whether to keep or erase the storage contents.</p>
<b>Storage card</b>	<p>Your phone comes with a microSD card already installed.</p> <p>You can store your files such as photos, music, and videos to this removable storage.</p> <p>When you connect your phone to your computer, this storage is accessible and you can copy files between them.</p>

The default storage for your files, whether it's the **Phone storage** or your storage card, may vary from app to app. Some apps allow you to set the default storage.

## Connecting your phone to a computer

Whenever you connect HTC Rezound with Beats Audio to a computer using the USB cable, the Choose a connection type screen opens and lets you choose the type of USB connection.

Select one of the following choices, and then tap **Done**:

<b>Charge only</b>	Select this option if you only want to charge the battery while connected to your computer.
<b>Disk drive</b>	Select this mode when you want to copy files between HTC Rezound with Beats Audio and your computer. When on Disk drive mode, you will not be able to use apps on HTC Rezound with Beats Audio that access the storage such as Camera.
<b>HTC Sync</b>	Select this option to synchronize contacts, calendar, and other information between your computer and HTC Rezound with Beats Audio.
<b>Internet Connection Mode</b>	When you do not have an Internet connection on your computer, you can select this mode to share the mobile data connection of HTC Rezound with Beats Audio with your computer.



**Internet pass-through**

If you don't have a data plan or you don't have access to a Wi-Fi network, you can select this mode to share your computer's Internet connection with HTC Rezound with Beats Audio.

## Copying files to or from the phone storage or storage card

You can copy your music, photos, and other files to HTC Rezound with Beats Audio.

1. Connect HTC Rezound with Beats Audio to your computer using the supplied USB cable.
2. On the Choose a connection type screen, select **Disk drive**, and then tap **Done**. Your computer recognizes accessible storages on HTC Rezound with Beats Audio as removable disks.
3. Navigate to either the phone storage or storage card.
4. Copy the files from your computer to any of the removable disks, or vice versa.
5. After copying the files, unmount the removable disks (on the connected HTC Rezound with Beats Audio) as required by your computer's operating system to safely disconnect HTC Rezound with Beats Audio.

If you want to keep HTC Rezound with Beats Audio connected to the computer but want it to be able to access the phone storage or storage card, open the Notifications panel, tap **Disk drive**, select an option except **Disk drive**, and then tap **Done**.

## Copying text, looking up information, and sharing

In apps such as the web browser and Mail, you can select text and choose what you want to do with it.

### Selecting text

1. Press and hold on a word.
2. Drag the start and end markers to highlight the surrounding text you want to select.

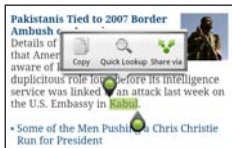

To copy the address of a linked web page, press and hold the link, and then tap **Copy link URL**.

### Copying and pasting text





1. After you have selected the text you want to copy, tap **Copy**.  
The selected text is then copied to the clipboard.
2. In a text entry field (for example while composing an email), press and hold at the point where you want to paste the text.
3. Tap **Paste**.

---

## Searching or translating text

---

1. After you have selected the text you want to search for or translate, tap .
2. Tap one of the following tabs:

	<b>Google Search</b> Look for related information using Google Search, based on the text that you selected.
	<b>Wikipedia</b> Look for related information on Wikipedia®, based on the text that you selected.
	<b>YouTube</b> Look for videos on YouTube®, based on the text that you selected.
	<b>Google Translate</b> Translate the text to another language.

---

## Sharing text

---

1. After you have selected the text you want to share, tap .
2. Choose where to paste and share the selected text, such as in an email message or Facebook status update.

## Printing

Connect HTC Rezound with Beats Audio to a supported printer and print out documents, email, meeting invitations, photos, and more.



- Both printer and HTC Rezound with Beats Audio must be turned on and connected to the same local network. Connect HTC Rezound with Beats Audio to the local network using Wi-Fi. To learn how to connect the printer to a local network, refer to your printer user guide.
- The local network must not be behind a firewall.

1. While in an app such as Internet, Mail, Calendar, or Polaris Office, open the item you want to print.
2. Press MENU , and then tap **Print** (or **More > Print**).
3. On the Print screen, tap the printer you want to use.
4. If there's more than one page to print, set the page range that you want.



Tap **Advanced** to set the page size, print layout, and page orientation, and choose if you want to print in color or black and white.

5. Tap **Print**.

You can check the printing details by opening the Notifications panel, and then tapping the item you're printing.

# Personalizing

## Making HTC Rezound with Beats Audio truly yours

Make HTC Rezound with Beats Audio look and sound just the way you want it. Personalize it with a different wallpaper, skin, ringtone, and notification sound for events such as incoming text, email, and calendar reminders.

Tap the Personalize button  right on the Home screen to get started.

## Personalizing HTC Rezound with Beats Audio with scenes

HTC Rezound with Beats Audio becomes multiple phones in one when you use scenes. Scenes are personalized Home screen layouts that you can quickly apply. By switching between scenes, you instantly turn HTC Rezound with Beats Audio into your perfect weekend phone, travel phone, work phone, or pure play phone.



Everytime you add or modify something on the Home screen, HTC Rezound with Beats Audio automatically saves your changes to the current scene selected.

---

### Using a preset scene

---

HTC Rezound with Beats Audio features preset scenes, each preconfigured with a different wallpaper and collection of widgets that reflect different

moments in your life. You can choose a scene that is suitable for work, play, travel, or your social life.



1. From the Home screen, press MENU , and then tap **Personalize**.
2. On the Display tab, tap **Scene**.
3. Slide your finger on the screen from right to left to select the scene you want.
4. Tap **Apply**.

---

### Creating a new scene

---

You'll start with an empty Home screen when you create a new scene.

1. From the Home screen, press MENU , and then tap **Personalize**.
2. On the Display tab, tap **Scene**.
3. Press MENU , and then tap **New**.
4. Enter a new scene name, then tap **Done**.
5. Personalize the scene by adding widgets and other elements, arranging the Home screen layout, and changing the skin or wallpaper. All of your changes will be automatically saved to this scene.

---

### Renaming a scene

---



1. From the Home screen, press MENU , and then tap **Personalize**.
2. On the Display tab, tap **Scene**.

3. Slide your finger on the screen from right to left to select the scene you want to rename.
4. Press and hold a scene thumbnail, then tap **Rename**.
5. Enter a new scene name, then tap **Done**.

---

## Deleting scenes

---

1. From the Home screen, press MENU , and then tap **Personalize**.
2. On the Display tab, tap **Scene**
3. Press MENU , and then tap **Delete**.
4. Slide your finger on the screen from right to left to browse through scenes, then tap one or more scenes you want to delete.
5. Tap **Delete**.

## Changing your wallpaper

Personalizing your wallpaper with your favorite photo is a quick and easy way to give HTC Rezound with Beats Audio a fresh look. Browse the collection of wallpapers included in HTC Rezound with Beats Audio or choose from photos that you have taken with the camera. You can also change your Home screen to use an animated wallpaper.

1. From the Home screen, tap .
2. On the Display tab, tap **Wallpaper**.

3. Tap one of the following:

<b>Gallery</b>	Choose an existing photo. Crop the photo and then tap <b>Save</b> .
<b>HTC wallpapers</b>	Choose a preset wallpaper, then tap <b>Preview &gt; Apply</b> .
<b>Live wallpapers</b>	Choose from preset animated wallpapers. Tap <b>Preview</b> to view the animation, and then tap <b>Apply</b> .

## Applying a new skin

Personalize beyond the Home screen by applying a new skin. Skins are set to give a different look and feel to most onscreen buttons, application screens, option menus, and other items.

1. From the Home screen, tap .
2. On the Display tab, tap **Skin**.
3. Slide your finger on the screen from right to left to select the skin you want.
4. Tap **Apply**.



## Personalizing your Home screen with widgets

Widgets put at-a-glance important information and media content up front on your Home screen. Some widgets are already added to your Home screen for your convenience. You can add more from the available selections of widgets.

---

### Adding a widget to your Home screen

---

1. Go to a part of the Home screen where there's space to add a new widget.
2. Press MENU , and then tap **Personalize**.
3. On the Add to home tab, tap **Widget**.
4. Select a widget that you want.
5. Most HTC widgets are available in a variety of designs and sizes to suit your needs. Slide your finger on the screen from right to left to view the different styles, and then tap **Select** to choose one.

You can also add widgets that allow you to quickly switch on or off certain settings such as Wi-Fi and Bluetooth. Scroll down the widgets list, tap **Settings**, and then tap the widget that you want.

---

## Changing the settings of a widget

---

You can modify basic settings of some widgets (for example, the People and Mail widgets) from the Home screen.

1. Press and hold a widget on the Home screen. HTC Rezound with Beats Audio vibrates and you'll see a colored box around the widget. Don't lift your finger just yet.
2. Drag the widget to the **Edit** icon (if it's enabled).



The relevant screen where you can change some settings for this widget then opens.

3. Customize the widget settings.

## Adding icons and other shortcuts on your Home screen

Place app icons on your Home screen to open apps quicker. You can also add shortcuts to settings and specific information such as a bookmarked webpage, someone's phone number, a music playlist, route directions, and many other items, to your Home screen.



The shortcuts available depend on the apps that are installed on HTC Rezound with Beats Audio.

1. Go to a Home screen where there's space to add a new icon or shortcut.
2. Press MENU , and then tap **Personalize**.
3. On the Add to Home tab, tap **App** to add an app icon, or **Shortcut** to add a shortcut to a setting or information.



To add an app icon on the Home screen, tap , and then press and hold an app icon. Without lifting your finger, drag the icon to an empty area on the Home screen, and then release it.

## Adding folders on your Home screen

Use folders to group related apps and other shortcuts to keep your Home screen tidy and organized. You can also add information folders that show up-to-date information such as Bluetooth received files, your Facebook phonebook, and more.

---

### Creating a new folder and adding items to it

---

1. Go to a part of the Home screen where there's space to add a new folder.
2. Tap  > Folder.
3. Tap New Folder.
4. Press and hold an app icon or a shortcut that you want to move to the folder. HTC Rezound with Beats Audio then vibrates. Don't lift your finger just yet.
5. Drag the app icon or shortcut and drop it on top of the folder.

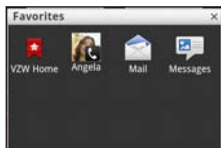

Simply tap the folder to open it so you can access the apps and shortcuts inside the folder.

---

### Renaming a folder

---

1. Tap the folder to open it.

2. Press and hold the folder window's title bar.
3. Enter a new folder name and then tap **OK**.

## Rearranging or removing widgets and icons on your Home screen

Rearrange the widgets and icons on your Home screen to make room for adding more items. You can also remove widgets and icons that you don't frequently use.

---

### Moving a widget or icon

---

1. Press and hold the widget or icon you want to move. HTC Rezound with Beats Audio vibrates and you'll see a colored box around the widget or icon. Don't lift your finger just yet.
2. Drag the widget or icon to a new location on the screen.
  - You can pause at the left or right edge of the screen to drag the widget or icon onto another Home screen panel.
  - When you drag an icon to a spot that's occupied by another icon, the occupant automatically moves away to give room.
3. When the widget or icon is where you want it, lift your finger.

---

## Removing a widget or icon

---

1. Press and hold the widget or icon you want to remove. HTC Rezound with Beats Audio vibrates and you'll see a colored box around the widget or icon. Don't lift your finger just yet.
2. Drag the widget or icon to the **Remove** icon.
3. When the widget or icon also turns red, lift your finger.

## Rearranging the Home screen

Reorder your Home screen panels in any way that fits how you use them. For example, move the panels with frequently-used widgets, shortcuts, and folders closer to the main Home screen.



The main Home screen is the panel that is bordered by a thin line in Leap view.

1. Pinch the Home screen to show the Leap view.
2. Press and hold the thumbnail of the home screen you want to move. HTC Rezound with Beats Audio then vibrates. Don't lift your finger just yet.

3. Drag the thumbnail to its new position, and then lift your finger.

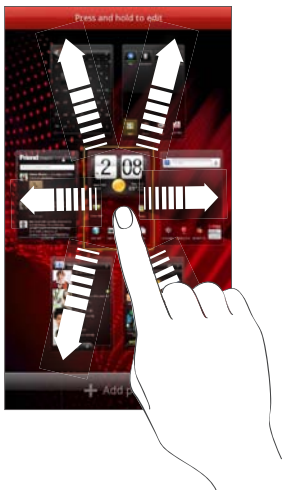



---

## Removing a Home screen panel

---

If you feel you need fewer Home screens, you can remove some.

1. On the Home screen, pinch the touch screen or press HOME  to go to Leap view.
2. Press and hold the panel you want to remove. Don't lift your finger just yet.
3. Drag the panel to .

---

## Adding back a Home screen panel

---

Add back a Home screen if you have more widgets, shortcuts, and apps that you want to access right away.

1. On the Home screen, pinch the touch screen or press HOME  to go to Leap view.
2. Tap the **Add panel** button. A new Home screen appears. You can start adding widgets, shortcuts, and apps.



## Using sound sets

Each sound set gives you a different combination of sounds for your ringtone and notifications such as incoming messages, email, calendar event reminders, and more. By switching between sound sets, you can instantly make HTC ReSound with Beats Audio ring or alert you with fun sounds when you're out with friends or change to subtle sounds while you're at work.

---

## Choosing a preset sound set

---

1. From the Home screen, tap  > **Sound set**.
2. On the Sound sets screen, tap a sound set name.
3. You can tap  to listen to the different sounds for that sound set.
4. Tap **Apply**.



---

## Creating a sound set

---

1. From the Home screen, tap  > **Sound set**.
2. On the Sound sets screen, tap **New sound set**.
3. Enter a new sound set name, and then tap **Done**.

The newly created sound set is then added to the list of sound sets. You can assign different tones to the sound set to your preference.

---

## Changing your ringtone, notifications, and sounds

---

Change your ringtone, notification sounds, and alarms to suit your mood or lifestyle. Choose different sounds from the preset selection or your storage card (except for notification sounds).

1. From the Home screen, tap  > **Sound set**.
2. Choose a sound set you want to customize or create a new one, and then tap **Apply**.
3. Change the ringtone, notification sound, and alarm from the Personalize screen.  
Go to the Messages, Mail, and Calendar apps to choose sounds for new messages, email, and calendar reminders respectively.

HTC ReSound with Beats Audio automatically saves your choices to the current sound set.

---

## Deleting sound sets

---

1. From the Home screen, tap  > **Sound set**.

2. Press MENU , and then tap **Delete**.
3. Tap one or more sound sets you want to delete.
4. Tap **Delete**.

## Rearranging or hiding application tabs

You can rearrange the tabs of some apps to prioritize the types of information you frequently use or remove the tabs you don't really need.

1. Open an app that has the usual tabs at the bottom of its screen.



2. Press and hold a tab. When the screen changes and shows you the area where you can rearrange icons, lift your finger.
3. Do any of the following:

<b>Add a tab</b>	Press and hold a tab that you want to add, and then drag it beside the other tabs.
<b>Move a tab</b>	Press and hold the tab you want to move, and then drag it to its new position.
<b>Remove a tab</b>	Press and hold a tab you want to hide, then drag it up.

4. When you're done, press **BACK** .

---

## Adding a tab back

---

1. Open the app from which you previously removed some tabs.
2. Press and hold a tab. When the screen changes and shows you some of your hidden tabs, lift your finger.
3. Press and hold the tab you want to show, then drag it down to where you want to position it again.

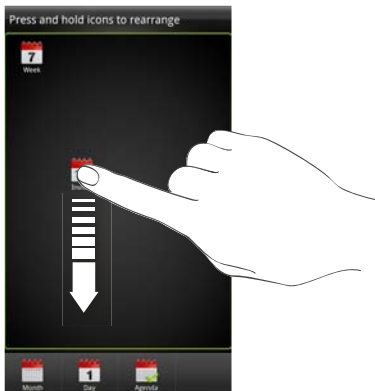

4. When you're done, press BACK .

## Customizing the lock screen style

Choose from a selection of active lock screens that show live information such as animated weather and stock updates.

1. From the Home screen, tap .
2. On the Display tab, tap **Lock screen style**.
3. Slide your finger left or right to choose a lock screen style.
4. Tap the lock screen style to see a preview. If you want to further customize it, tap **Settings**.
5. Tap **Apply** when you're done.

---

## Customizing the shortcuts on a lock screen

---

You can choose what shortcuts you want for your lock screen so you can unlock the screen straight into your favorite app.

1. From the Home screen, press MENU , and then tap **Personalize**.
2. On the Display tab, tap **Lock screen shortcuts > Choose lock screen shortcuts**.
3. Tap a shortcut that you want to change, and then choose another app to replace it .
4. Tap **Done**.

# Phone calls

## Different ways of making calls



Besides making calls from the phone dialer screen on HTC Rezound with Beats Audio, you can tap a number in a text message or email to call, or press a single number on the phone dialer to quickly call a contact.

## Making a call on the Phone dialer screen

You can either dial a number directly, or use the Smart dial feature to search and call a stored contact or a number from your call history.

1. On the Home screen, tap **Phone**.
2. Begin entering the first few digits of a phone number or characters of a contact name on the phone keypad. The Phone dialer screen then displays a list of matching numbers and names.



If you enter a wrong digit or letter, tap  to delete it. To erase the entire entry, press and hold .

3. Slide your finger up on the filtered list to close the phone keypad and see if there are more matching numbers or contacts.
4. To place a call, do one of the following:
  - Tap a phone number or contact from the list.
  - After entering a complete number, tap **Call**.

- To call a different phone number associated with the contact, you can tap  at the right side of the contact name. On the contact details screen, tap the number you want to call.

While dialing or when the call is in progress, the status bar displays the call in progress icon .

---

## What is Smart dial?

---

The phone dialer's Smart dial feature makes it quick and easy for you to place a call.

Simply enter the phone number or first few letters of the person's name you want to call. Smart dial automatically searches and filters your stored contacts and the phone numbers from the call history.

## Using Speed dial

Use Speed dial to call a phone number with a single tap. For example, if you assign a contact's number to the number 2 key, you can just press and hold 2 to dial the number.





The number 1 key is reserved for your voicemail. Press and hold this key to call voicemail and retrieve your voicemail messages.

---

## Assigning a speed dial key

---

1. On the Home screen, tap **Phone**.
2. Press MENU , and then tap **Speed dial** > .

3. Enter the name of the contact you want to add. When the name comes up in the list, tap the name.
4. On the Speed dial screen, choose the phone number of the contact to use, and a speed dial key to assign.
5. Tap Save.



You can also set a speed dial key in People. Tap a contact, press MENU , and then select Set speed dial (or More > Set speed dial).

## Calling a phone number in a text message

1. Tap the phone number within the message.

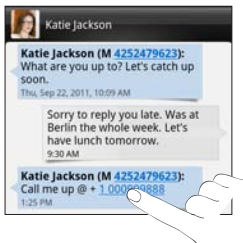

2. Tap Call.



To call the message sender, tap the received message, and then tap **Call** on the options menu.

## Calling a phone number in an email

Want to call a number that's in an email? No problem.

1. In the email body, tap the phone number.
2. Edit the number if necessary.
3. Tap **Call**.

## Calling a phone number in a Calendar event

Tapping a phone number in a Calendar event lets you see the event details such as conference call ID number or meeting PIN code while on the Phone dialer screen.

1. Open an event in Calendar.
2. On the Event details screen, tap the phone number.
3. Tap **Call**.

## Making an emergency call

In some regions, you can make emergency calls from HTC Rezound with Beats Audio even if you don't have a SIM card installed or your SIM card has been blocked.

1. On the Home screen, tap **Phone**.



2. Dial the emergency number for your locale, and then tap **Call**.

If you've enabled but forgotten your lock password or lock pattern, you can still make emergency calls by tapping **Emergency call** on the screen.

## Receiving calls

When you receive a phone call from a contact, the Incoming call screen appears.



You can use the polite ringer and pocket mode features for receiving calls. To find out how, see [Changing sound settings](#) on page 328.

---

## Answering a call

---

Do one of the following:

- Tap **Answer**.

- If the display is off when you get a call, the Lock screen appears. Drag  to the ring to unlock the screen and answer the call.



---

## Rejecting a call

---

Do one of the following:

- Tap **Decline**.
- If the display is off when you get a call, the Lock screen appears. Drag  to the ring on the Lock screen.
- Press the POWER/LOCK button twice to reject a call.

---

## Muting the ringing sound without rejecting the call

---

Do one of the following:

- Press the VOLUME DOWN or VOLUME UP button.
- Press the POWER/LOCK button.
- Place HTC Rezound with Beats Audio face down on a level surface.



If HTC Rezound with Beats Audio is already facing down, it will still ring when there are subsequent incoming calls.

---

## HTC Caller ID

---

Everytime you make a call or your friend gives you a ring, you get to see your friend's latest status update from social networks like Facebook or Twitter right on the call screen. You also won't miss people's birthdays. You'll see a birthday reminder, if your friend's birthday will occur sometime within the next seven days.

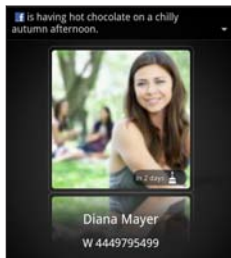

## What can I do during a call

When a call is in progress, use the buttons onscreen to mute or unmute the microphone or to turn the speakerphone on or off. You can also press MENU  and choose other options such as muting the microphone, and more.

---

### Switching between calls

---

If you're already on a call and accept another call, you can choose to switch between the two calls.

1. When you receive another call, tap **Answer** to accept the second call and put the first call on hold.
2. To switch between the calls, tap the person you want to talk to on the screen.



---



## Turning the speakerphone on during a call

---



To decrease potential damage to your hearing, do not hold HTC Rezound with Beats Audio against your ear when the speakerphone is on.

Do one of the following:

- Flip HTC Rezound with Beats Audio over during a call (be sure that **Flip for speaker** is selected in HOME  > MENU  > **Settings > Sound**).
- On the call screen, tap .



The speakerphone icon  appears in the status bar when the speakerphone is on.

To turn the speakerphone off, just flip HTC Rezound with Beats Audio over again, facing it up. Or tap  again.

---

## Muting the microphone during a call

---

On the call screen, tap  to toggle between turning the microphone on or off. When the microphone is turned off, the mute icon  appears in the status bar.

---

## Ending a call

---

Do one of the following to end the call:

- On the call screen, tap **End call**.



If the display is off, press POWER/LOCK to turn on the screen so you can tap **End call**.

- Slide open the Notifications panel, then tap .

If the phone number of the person who called is not in your contacts list, you can choose to save the number to your contacts list after you hang up.

## Using Assisted dialing

When you're on a trip abroad, it's easy to dial friends and family from home. Your home country code is automatically added when you make calls to your contacts while roaming.

1. On the Home screen, tap **Phone**.
2. Begin entering the first few characters of a contact name on the phone keypad.
3. Tap a contact you want to call.

If you selected a contact whose phone number has a leading zero, HTC ReSound with Beats Audio will automatically prepend it with your home country code when dialing. If there's already a plus (+) sign and country code before the phone number, HTC ReSound with Beats Audio will just dial as is.





HTC Rezound with Beats Audio dials as is and does not prepend your home country code when you call phone numbers that are not stored in HTC Rezound with Beats Audio. When manually entering a phone number to call, you need to enter a plus (+) sign and country code before the number.

---

### Editing a country's international call settings



---

1. From the Home screen, press MENU , and then tap **Settings**.
2. Tap **Call > Assisted Dialing**.
3. Under Reference Country, select the country whose settings you want to edit.
4. Press MENU , and then tap **Edit**.
5. Edit the **Country Code**, **IDD Prefix** (International Direct Dial), **NDD Prefix** (National Direct Dial), **Area/City Code** and **National Number Length** (length of phone number).
6. Tap **Save**.

---

### Resetting the reference country to the default

---

1. From the Home screen, press MENU , and then tap **Settings**.
2. Tap **Call > Assisted Dialing**.
3. Under Reference Country, select the country whose settings you want to set to default values.
4. Press MENU , and then tap **Set Default**.

## Internet calls



When you're connected to a Wi-Fi network, you can make and receive calls through an Internet calling account.

**F** Before you add an Internet calling account, make sure that you've registered with an Internet calling service that supports voice calls over Session Initiation Protocol (SIP). Internet calls to phone numbers may incur additional fees.

---

### Adding an Internet calling account

---

1. From the Home screen, press MENU , and then tap **Settings > Call**.
2. Under Internet call settings, tap **Accounts**.
3. Tap **Add account**.
4. Enter your account details.
5. Press BACK  to save your account.
6. To set HTC Rezound with Beats Audio to receive Internet calls on your added account, tap the **Receive incoming calls** check box.



---

## Making an Internet call

---

Make an Internet call to either your contact's Internet calling account or phone number.



Internet calls to phone numbers may incur additional fees. Contact Verizon Wireless for details.

Call any of the following:

### Internet calling account

- In People, tap a contact who has an Internet calling account, and then tap **Internet call**.
- In Call History, tap an Internet call log.

### Phone number

See [Making a call on the Phone dialer screen](#) on page 69. But first, set HTC Rezound with Beats Audio to use Internet calling for your outgoing calls. From the Home screen, press MENU , and then tap **Settings > Call**. Tap **Use Internet calling**, and then select either **For all calls** or **Ask for each call**.

## Using Call history

Use Call History to check missed calls, your dialed numbers, and received calls.

---

### Checking a missed call

---



You will see the missed call icon  in the status bar when you miss a call.

1. Slide open the Notifications panel to check who the caller is.
2. To return the call, tap the missed call notification. Then tap the caller's name or number on the Call History screen.

---

### Checking calls in the Call History

---

1. On the Home screen, tap **Phone**.
2. Slide to the Call History tab.
3. On the Call History screen, you can:
  - Tap a name or number in the list to call.
  - Press and hold a name or number in the list to display the options menu.
  - Tap  to check only the call history of a particular contact.
  - Press MENU , then tap **View** to display just a particular type of calls such as missed calls or outgoing calls.

---

## Adding a new phone number to your contacts from Call History

---

1. On the Call History screen, press and hold the phone number that you want to save, and then tap **Save to People**.
2. Choose whether to create a new contact or save the number to an existing contact on HTC Rezound with Beats Audio.
3. Do any of the following:
  - When creating a new contact, enter the contact name, contact type, and other information in the blank contact record that appears. The phone number is automatically added to the mobile field in the phone section. To store it as another type of number, for example a home number, tap the **Mobile** button.
  - When saving the number to an existing contact, tap a contact stored on HTC Rezound with Beats Audio, and then select the number type.
4. Tap **Save**.

---

## Clearing the Call History list

---

On the Call History screen, do one of the following:

Remove one name or number	Press and hold the name or number, and then tap <b>Delete from call history</b> .
Clear the entire list	Press MENU  , and then tap <b>Remove call history</b> . Tap <b>Select all &gt; Delete</b> .

## Call services

HTC Rezound with Beats Audio can directly link to the mobile phone network, and enable you to access and change the settings of various phone services. Call services may include call forwarding, call waiting, voicemail, and more. Contact Verizon Wireless to find out about the availability of call services.

To open call services, press MENU  from the Home screen, and then tap Settings > Call.

<b>Voicemail service</b>	Shows the current voicemail service being used.
<b>Voicemail settings</b>	Specify another voicemail number aside from the one specified by your service provider.
<b>Clear voicemail notification</b>	If you have a notification of a new voicemail, you can clear the notification with this option.
<b>Auto Retry</b>	When enabled, the phone automatically redials a number when the attempted call fails.
<b>Hearing aids</b>	Turn on the Hearing Aid Compliance feature that reduces interference to hearing aids.
<b>Phone settings</b>	Modify your phone settings such as automatic saving of an unknown contact number when a call with that number ends.
<b>Assisted Dialing</b>	Assisted Dialing allows you to easily dial international calls while roaming in another country.
<b>TTY mode</b>	Enable TTY (Teletypewriter) support for your phone.

<b>Voice Privacy</b>	Encrypts outgoing voice calls and uses secure channels when available.
<b>NBPCD</b>	Set the calling parameters for the current country, such as country code and IDD prefix.
<b>Accounts</b>	Add, modify, or remove Internet calling accounts. You can also choose whether to receive incoming Internet calls.
<b>Use Internet calling</b>	Select whether to use Internet calling for all calls you make or for Internet address calls only, or to be asked which you prefer for each call you make.

## Turning Airplane mode on or off

In many countries, you are required by law to turn off wireless devices while on board an aircraft. A way to turn off wireless functions quickly is to switch HTC Rezound with Beats Audio to Airplane mode.

When you enable Airplane mode, all wireless radios on HTC Rezound with Beats Audio are turned off, including the call function, data services, Bluetooth, and Wi-Fi. When you disable Airplane mode, the call function is turned back on and the previous state of Bluetooth and Wi-Fi is restored.

To turn Airplane mode on or off, press and hold POWER/LOCK, and then tap **Airplane mode**.

When enabled, the Airplane mode icon  is displayed in the status bar.

## Visual Voice Mail

Rather than calling your voice mail number, you can see and manage your voice mail messages right on the HTC Rezound with Beats Audio screen with Visual Voice Mail.



- Visual Voice Mail is only available in the National Enhanced Services Coverage Area. Specific terms, conditions and monthly charges apply. Basic Voice Mail and V CAST™ Coverage Area are required and V Block must be removed to use Visual Voice Mail.
- Anyone in possession of this device can access voice mail. To limit unauthorized access to voice mail, consider locking the phone when not in use.

---

### Setting up Visual Voice Mail

---

1. From the Home screen, tap  > **Voice Mail** > **Visual Voice Mail**.
2. When prompted, enter your basic voice mail password.
3. Read the terms of use statement and then tap **Subscribe** to continue.
4. Tap **Exit** and wait 5 minutes before using Visual Voice Mail.

---

### Using Visual Voice Mail

---

1. From the Home screen, tap  > **Voice Mail**. If this is the first time you use Visual Voice Mail after setting it up, you are asked to read the terms of use. Read the terms of use and tap **Accept** to continue.

2. On the Voicemail screen, you can:
  - Tap **Compose voicemail** to record and send a voice mail.
  - View all your voice mail messages.
  - Press MENU  to sort and delete voice mails, call your voice mail box, configure voice mail settings, and more. You can also sync with the Visual Voice Mail server to refresh your voice mail messages list.

# Messages

## Opening Messages

Keep in touch with important people in your life. Use the Messages app to compose and send text (SMS) and multimedia messages (MMS).

From the Home screen, tap  > **Messages**. The All messages screen opens, where all your sent and received messages are neatly grouped into conversations, by contact name or phone number.

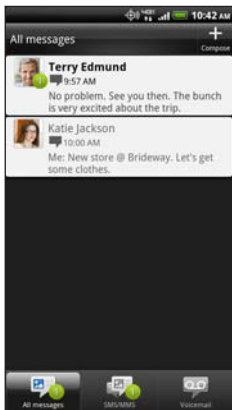



- Scroll up or down the list of conversations by swiping your finger on the screen.
- Tap a contact name or number to view the exchange of messages.





You can also view your messages on the Home screen with the Messages widget.

## Sending a text message (SMS)

1. From the Home screen, tap  > Messages.
2. Tap .
3. Fill in one or more recipients. You can:
  - Enter the first few letters of a contact name or starting digits of a mobile number. As you type, matching names with phone numbers from your stored contacts are displayed. Tap a name or one of the contact's numbers.
  - Tap , and then select the phone numbers of the contacts to whom you want to send the message. You can also select contact groups as recipients.
  - Enter the complete phone numbers directly in the To field.
4. Tap the box that says Add text, and then enter your message.

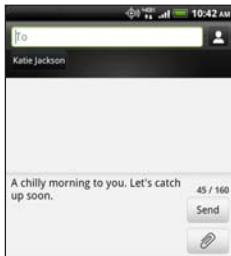





- There is a 160-character limit for a single text message (displayed above the **Send** button). If you exceed the limit, your text message will be delivered as one but you will be billed for the additional message.
- Your text message automatically becomes a multimedia message if you enter an email address as the recipient, add a message subject, attach an item, or compose a very long message.



5. Tap **Send**, or press **BACK**  to save the message as a draft.

## Sending a multimedia message (MMS)



MMS attachments should not exceed 1200 KB.

1. From the Home screen, tap  > **Messages**.
2. Tap .
3. Fill in one or more recipients. You can:
  - Enter the first few letters of a contact name or starting digits of a mobile number. As you type, matching names with phone numbers and email addresses from your stored contacts are displayed. Tap a contact's number or email address.
  - Tap , and then select the phone numbers of the contacts to whom you want to send the message. You can also select contact groups as recipients.
  - Enter the complete phone numbers or email address directly in the **To** field.

- To add a subject line, press MENU  and then tap **Add subject**.
- Tap the box that says **Add text**, and then enter your message.
- Tap  and then choose the type of attachment.

Picture	Take a photo and attach it, or attach an existing photo.
Video	Record a video and attach it, or attach an existing video.
Audio	Make a voice recording and attach it, or attach an existing audio file.
App recommendation	Choose an app you've installed from Android Market that you want to share with others. The URL from which the app can be downloaded will be inserted to your message.
Location	Add your current location (requires GPS to be turned on), or a location you pick on a map to your message.
Contact (vCard)	Select a contact, and then select the information to attach.
Appointment (vCalendar)	Select the calendar event you want to attach.





After adding an attachment, tap  to see options for replacing, viewing or removing your attachment.

- Tap **Send**, or press BACK  to save the message as a draft.

## Why isn't the contact's email address showing up when I enter a contact name?

If only phone numbers are showing up when you're entering a contact name, go to the Messages settings to enable displaying email addresses.

1. If you've created a new message, press BACK  first to return to the All messages screen.
2. Press MENU  and then tap **Settings** > **General**.
3. Select the **Show email address** check box.

---



### Creating a slideshow

---

1. After you've added either a photo, video, or audio in the multimedia message you're composing, tap  > **Slideshow**.
2. Choose where you want to insert the next slide.
3. Right after adding a slide, do any of the following:

Add a photo or video to a slide

Tap , and then choose to add a photo or a video.

Add music or a voice recording to a slide	Tap  > <b>Audio</b> .
Add a caption to a slide	Tap <b>Add text</b> and then enter your caption.
Edit a slide	Tap  , and then choose to replace, remove, or set the duration of the slide.
Preview the slideshow	Press <b>MENU</b>  , and then tap <b>Preview</b> (or <b>More &gt; Preview</b> ). Tap once on the preview screen to see playback controls.

4. When finished, tap **Send**, or press **BACK**  to save the message as a draft.

## Resuming a draft message

1. On the All messages screen, press **MENU** , and then tap **Drafts**.
2. Tap the message and then resume editing it.
3. Tap **Send**.

## Viewing and replying to a message

Depending on your notification settings, HTC Rebound with Beats Audio plays a sound, vibrates, or displays the message briefly in the status bar when you receive a new message. A new message icon  is also displayed in the status bar.



1. To open and read the message, you can:
  - Press and hold the status bar, and then slide your finger down to open the Notifications panel. Then tap the new message notification.
  - Go to the Messages app and open the message.
2. While reading the message, you can reply with a text or multimedia message.

You can also do the following while reading the message:

- Call the phone number contained in the message by tapping the number.
- Tap the email address contained in the message to send an email.
- Tap a link in the message to open it in the web browser.

- Tap the message to open the options menu and choose what you want to do with the message (such as forward, share, and more).

---

## Adjusting the font size of your messages

---

While reading a message conversation with a contact, spread out two fingers on the screen to zoom in and make the text size bigger. Pinch the screen to zoom out.



You can also press MENU , and then tap **More > Text size**.

---

## Replying to another phone number of the contact

---

When a contact has multiple phone numbers stored on HTC Rezound with Beats Audio, you'll see the particular phone number used below the contact's name.

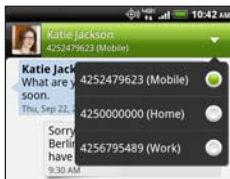

Keep in mind that your response will be sent to the phone number of the latest message you've received from this contact.

1. On the All messages screen, tap a contact (or phone number) to display the exchange of messages with that contact.

2. Tap , and then select another phone number of this contact.
3. Tap the box that says **Add text**, then enter your reply message.
4. Tap **Send**.

---

## Saving a text message in the Tasks app

---

Save a text message in your Tasks list so you can remind yourself when to reply.

1. On the All messages screen, tap a contact (or phone number) to view the exchange of messages with that contact.
2. Tap the message you want to save, and then tap **Save as task**.
3. On the New Task screen, enter a name for the task.
4. Enter other task details, and then tap **Save**.

## Forwarding a message

1. On the All messages screen, tap a contact (or phone number) to view the exchange of messages with that contact.
2. Tap the message you want to forward, and then tap **Forward**.
3. In the **To** field, fill in one or more recipients.
4. Tap **Send**.





While viewing the exchange of messages with the contact, you can also press MENU , tap **Forward** (or **More > Forward**), and then tap the message you want to forward.

## Viewing and saving an attachment from a multimedia message

If you are concerned about the size of your data downloads, check the multimedia message size first before you download it.



When **Auto-retrieve** in MMS settings is disabled, only the message header is downloaded. To download the entire message, tap the **Download** button at the right side of the message.

- If there's a media attachment such as a photo or video in a received message, tap it to view the content.
- If the attachment is a contact (vCard), tap it to view the contact information, then tap **Save** to add to your contacts.
- If the attachment is an appointment or event (vCalendar), tap it to choose the calendar where to save it, and then tap **Import**.
- To save the attachment to your storage card, press and hold the multimedia message, and then choose to save the type of attachment from the options menu.

## Push messages

Push messages contain a web link. Often, the link will be to download a file that you have requested from a service provider.

When you receive a push message, a notification icon  is displayed in the status bar.

---

### Opening and reading a new push message



---

1. Press and hold the status bar, and then slide the status bar down to open the Notifications panel.
2. Tap the new message.
3. Tap **Visit website**.

---

### Viewing all your push messages

---

1. From the Home screen, tap  > **Messages**.
2. Press **MENU** , and then tap **Push messages**.



You can only see this option if you've previously received push messages.

## Managing message conversations

---

### Protecting a message from deletion

---

You can lock a message so that it will not be deleted even if you delete the other messages in the conversation.

1. On the All messages screen, tap a contact (or phone number) to display the exchange of messages with that contact.
2. Tap the message that you want to lock.
3. Tap **Lock message** on the options menu. A lock icon  is displayed at the right hand side of the message.

### Deleting a single message

---

1. On the All messages screen, tap a contact (or phone number) to display the exchange of messages with that contact.
2. Tap the message that you want to delete.
3. If the message is locked, tap **Unlock message** on the options menu, and then tap the message to display the options menu again.
4. Tap **Delete message** on the options menu.
5. When prompted to confirm, tap **OK**.

### Deleting several messages within a conversation

---

1. On the All messages screen, tap a contact (or phone number) to display the exchange of messages with that contact.

2. Press MENU  and then tap **Delete** (or **More > Delete**).
3. Tap **Delete by selection**.



You can also tap **Delete by phone number** if the contact used multiple phone numbers throughout the conversation and you want to delete the messages sent from a particular number.

4. Select the messages you want to delete and then tap **Delete**.



In the settings, you can set the Messages app to auto delete old messages per conversation.

---

## Deleting a conversation

---

1. Do any of the following:
  - On the All messages screen, press and hold a contact (or phone number) whose messages you want to delete, and then tap **Delete**
  - While looking at the exchange of messages in a conversation, press MENU  and then tap **Delete > Delete thread** (or **More > Delete > Delete thread**).

Any locked messages in the conversation thread will not be deleted unless you select the **Delete locked messages** check box.
2. When prompted to confirm, tap **OK** to delete the entire thread.



---

## Deleting several conversations

---

1. On the All messages screen, press MENU  and then tap **Delete**.
2. Select the conversation threads you want to delete.
3. Tap **Delete**. Any locked messages will not be deleted.

## Backing up your text messages to the storage card



1. From the Home screen, tap  > Messages.
2. Press MENU , and then tap **Backup SMS > Backup SMS**.
3. Enter a name for your backup file, and then tap **OK**.

---

## Importing text messages from the storage card

---

You can only import text messages that were exported to the storage card using the **Backup SMS** feature.

1. From the Home screen, tap  > Messages.
2. Press MENU , and then tap **Backup SMS > Restore SMS**.
3. Tap the backup file to import.
4. Tap **OK**.

## Setting message options

On the All messages screen, press MENU  and then tap **Settings**.

### Notifications

- Receive a notification in the status bar and set HTC Rezound with Beats Audio to vibrate or play a sound when a message arrives or when a message is not sent successfully, and choose a notification sound.
- Allow HTC Rezound with Beats Audio to show pop-up notifications on the screen when messages are sent successfully or not, or disable this option.
- If you don't want the content of received text messages to appear on the lock screen and status bar, clear the **Notification preview** check box.

### Text messages (SMS)

- Receive a report on the delivery status of your message.
- View or change the message service center number used. (We recommend that you don't change the number here as it may cause problems in receiving and sending messages.)
- View or delete text messages stored on your SIM card, or copy SIM card messages to device memory.

**Multimedia messages (MMS)**

- Receive a report on the delivery status of your message.
- Receive a report whether each recipient has read the message or deleted it without reading.
- Automatically download complete MMS messages including the message body and attachments in your service area and when roaming.
- Set the message priority and maximum file size of MMS messages. If the MMS message file size is exceeded, the message won't be sent.

**General**

- Search and display the sent message history, call history, and email addresses of stored contacts when you're adding message recipients.
- Set the number of lines of text to preview for each message on the All messages screen.
- Choose the maximum number of text or MMS messages to store in each conversation thread (excluding locked messages), and enable automatic deletion of unlocked older messages when set limits are reached.
- Forward received text and MMS messages to another phone number or email address. (This may incur extra fees.)
- Add a signature to your messages.

**Visual  
voicemail**

Set HTC Rezound with Beats Audio to vibrate or play a sound when a voicemail arrives, and choose a notification sound.



# Search and Web browser

## Searching HTC Rezound with Beats Audio and the Web

You can search for information on HTC Rezound with Beats Audio and on the Web by using Google Search. Some applications, such as People or Mail, have their own search function, which you can use to search only within those applications.

---

### Setting search options

---

1. From the Home screen, press MENU , and then tap **Settings**.
2. Tap **Search > Google search**.
3. Choose the settings that you want.

<b>Show web suggestions</b>	Display suggestions for Google web searches below the search box as you type.
<b>Use My Location</b>	Include your location in searches to get local search results.
<b>Search history</b>	Use suggestions from the web-based Google search history, from your Google Account. Tap <b>Manage search history</b> to view or manage the web search history associated with your Google Account on the web browser.







4. Press BACK .

5. Tap **Searchable items**, and then select the items you want included when doing a search.

---

## Performing searches on the Web and HTC Rezound with Beats Audio

---

1. From the Home screen, press SEARCH .
2. Choose where you want to search.  
Initially, the Google search box displays the **All** icon , indicating that it's configured to search on both the Web and HTC Rezound with Beats Audio. You can target your searches to just the Web only or to just a single application's information on HTC Rezound with Beats Audio. Tap  and then tap  to set the searchable items.
3. In the search box, enter the words you want to search for. As you type, matching items on HTC Rezound with Beats Audio and suggestions from Google web search are shown as a list.
4. Do one of the following:
  - If what you're searching for is in the list of suggestions, tap it in the list. The item opens in the appropriate application.
  - To edit an item in the list, tap . The item will appear in the search box, where you can edit it.
  - If what you're searching for is not in the list, tap  to search the Web. The web browser opens, displaying the results of a Google search.

## Using the web browser

Do one of the following to open the web browser and start surfing the Web:

- On the Home screen, tap **Internet**.
- From the Home screen, tap  > **Internet**.

---

### Going to a webpage

---

1. On the browser screen, tap the URL box on top of the screen.
2. Enter the webpage address using the keyboard. As you enter the address, matching webpage addresses will appear on the screen.
3. Do one of the following:
  - Tap an address to go directly to that webpage.
  - Continue typing in the webpage address, then tap **Go** .

---

### Changing the screen orientation

---

Turn HTC Rezound with Beats Audio sideways to display the web browser in landscape orientation.



If the screen orientation doesn't change automatically, turn on automatic screen orientation. From the Home screen, press MENU , tap **Settings** > **Display**, and then select the **Auto-rotate screen** check box.

---

## Navigating and zooming on a webpage

---

- You can swipe your finger on the screen to navigate and view other areas of the webpage.
- Tap the screen twice quickly to zoom in, then tap the screen twice quickly again to zoom out. You can also use your fingers to spread or pinch the screen to zoom in and out.

---

## Selecting a link on a webpage

---

You can tap a link to open it, or press and hold a link for more options.

Link	What to do
Webpage address (URLs)	<ul style="list-style-type: none"><li>▪ Tap the link to open the webpage.</li><li>▪ Press and hold the link to open a menu that allows you to open, bookmark, copy to the clipboard, share the link, and more.</li></ul>
Email address	<ul style="list-style-type: none"><li>▪ Tap to send an email message to the email address.</li><li>▪ Press and hold, then tap <b>Copy</b> on the menu to copy the email address to the clipboard. You can paste the email address later when creating a new contact or sending a new email message.</li></ul>

---

## Selecting an address or phone number on a webpage

---

On a webpage, you can:

- Tap an address to view the location on a map.
- Tap a phone number to call.

---

## Opening a new browser window

---

Open multiple browser windows to make it easier for you to switch from one website to another.

1. While viewing a webpage, press MENU  and then tap **Windows**.
2. Tap .

A new browser window opens.

---

## Switching between browser windows

---

1. While viewing a webpage, do one of the following:
  - Press MENU  and then tap **Windows**.
  - Pinch the screen (zoom out) until you see the other browser windows.

- Slide your finger until the webpage you want to view appears.



- Tap a webpage to display it in full screen.



Tap  to close a webpage.

## Downloading from the Web

Do more than just browsing the Web. You can download files such as photos and music as well as apps using the web browser.



Before downloading an app, check first its compatibility with HTC Rezound with Beats Audio to make sure it can be installed.

---

## Downloading apps from the Web

---

You can download apps directly from your favorite websites. Apps downloaded from the Web can be from unknown sources. To protect HTC Rezound with Beats Audio and your personal data, we strongly recommend that you download and install only apps you trust.

1. Open your web browser, then go to the website where you can download the app you want.
2. Follow the website's instructions for downloading the app.

Before you can install the downloaded app, you need to set HTC Rezound with Beats Audio to allow installation of third-party apps. From the Home screen, press MENU , then tap **Settings > Applications > Unknown sources**.

---

## Viewing your downloads

---

While viewing a webpage, press MENU  and then tap **Downloads (or More > Downloads)**.

## Viewing bookmarks and previously visited pages

You can store as many bookmarks as you want on HTC Rezound with Beats Audio. You can also access a convenient list of the sites you have visited, or quickly view the pages that you access most often.

---

### Bookmarking a webpage



---

1. While viewing a webpage, press MENU , and then tap **Add > Add bookmark**.
2. To bookmark the web page under a certain category (such as sports or dining), tap **Add tags** and enter a tag name. This groups similar web pages so you can easily locate them.
3. Edit the bookmark name if needed, and then tap **Done**.

---

### Opening a bookmark

---





1. While viewing a webpage, press MENU , and then tap **Bookmarks**.
2. Do one of the following:
  - On the Bookmarks tab , navigate to the bookmark you want to open, and then tap it.
  - On the Tags tab , open a tag group, navigate to the bookmark you want to open, and then tap it.



---

## Editing a bookmark



---

1. While viewing a webpage, press MENU , and then tap **Bookmarks**.
2. On the Bookmarks tab , press MENU , and then tap **Edit**.
3. Tap  at the right of the bookmark you want to edit.
4. Enter your changes, and then tap **Done**.

---

## Viewing a previously visited page



---

1. While viewing a webpage, press MENU , and then tap **Bookmarks**.
2. On the History tab , navigate to the page you want to view and then tap the page.

---

## Clearing the list of previously visited pages



---

1. While viewing a webpage, press MENU , and then tap **Bookmarks**.
2. On the History tab , press MENU , and then tap **Clear history**.

---

## Viewing a page that you often visit



---

1. While viewing a webpage, press MENU , and then tap **Bookmarks**.
2. On the Most visited tab , navigate to the page you want to view, and then tap the page.

---

## Clearing the list of most visited pages







---

1. While viewing a webpage, press MENU , and then tap **Bookmarks**.
2. On the Most visited tab , press MENU , and then tap **Clear all**.

---

## Changing the view of bookmarks or most visited pages

---

1. While viewing a webpage, press MENU , and then tap **Bookmarks**.
2. On the Bookmarks tab  or the Most visited tab , press MENU , and then tap **Thumbnails**, **List**, or **Grid** to change the view. For example, if you are in Thumbnails view and you want to view bookmarks in a grid, press MENU  and tap **List**, then press MENU  and tap **Grid**.

## Setting browser options

Customize the web browser to suit your browsing style. Set display, privacy, and security options when using the web browser.

From the browser screen, press MENU , and then tap **More** > **Settings**.

---

## Setting your home page

---

1. From the browser screen, press MENU , and then tap **More** > **Settings** > **Set home page**.
2. Select the home page you want to use.

---

## Browsing full versions of all websites

---

Some websites display a mobile version of their pages on phone web browsers. You can choose to view the full version of all pages, even for these sites.

From the browser screen, press MENU , tap **More > Settings**, and then clear the **Mobile view** check box.

---

## Choosing when to show Adobe Flash content

---

Choose which Adobe® Flash® content you want to see on a webpage, and when you want to view it.

1. From the browser screen, press MENU , and then tap **More > Settings > Enable plugins**.
2. Tap **On demand**.

After selecting **On demand**, you can show the Adobe Flash content by tapping  on the webpage.

# Camera

## Camera basics

Whether traveling for business or fun, enjoy taking photos and videos with the camera.

To open the camera, tap  from the Home screen, and then tap **Camera**.

---

## Viewfinder screen

---

You'll find the following onscreen controls and indicators on the Viewfinder screen:



- The onscreen controls let you switch between photo and video modes, add effects, and more.
- The auto focus indicator  tells you where the focus is on the shot.

- The shake detection indicator  shows up when your grip is shaky.
- The zoom bar lets you take anything from a long shot to a close-up of your subject.

---

## Zooming

---

Before taking a photo or video, you can first use the onscreen zoom bar to zoom in or out of your subject.

Simply slide your finger on the zoom bar to zoom in or out.

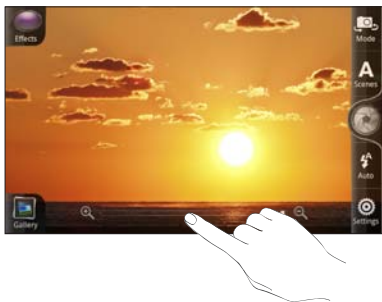

When you're recording video, the zoom bar is always shown onscreen. You can freely zoom in or out while recording.

---

## Auto focusing

---

Whenever you point the camera at a different subject or location, it shows the auto focus indicator at the center of the Viewfinder screen.

Let the camera auto focus on the center of the screen. Or you can tap another area on the screen that you want to focus on.

---

## Using the front camera

---

Take a picture or shoot a video of yourself using the front camera.

To switch to the front camera, on the Viewfinder screen, tap , and then slide the selection to **Front**.



Some camera features are not available when you're using the front camera, such as auto focusing, zooming, and face detection.

## Taking a photo

1. From the Home screen, tap  > **Camera**.
2. Before taking the photo, you can zoom in or out first on your subject.
3. Tap the flash button repeatedly to choose a flash mode depending on your lighting conditions.



Auto flash

	Flash on
	Flash off

4. Choose the resolution and other camera settings you want to use.
5. Choose an effect to apply to your photo.
6. Point the camera and focus on your subject.



If you're taking a photo of a group of people, the camera will automatically recognize faces and adjust the focus. You'll see boxes on people's faces.



Make sure the **Auto focus** and **Face detection** check boxes are selected in the camera settings.

7. When you're ready to take the photo, tap .
8. Choose what you want to do with the photo you've just taken.

## Recording video

1. From the Home screen, tap  > **Camera**.
2. On the Viewfinder screen, tap **Mode** and then tap the Photo/Video slider to select **Video**.
3. Choose the video quality and other camera settings you want to use.
4. Choose an effect to apply to your video.
5. Frame your subject on the Viewfinder screen.
6. Tap  to start recording.
7. You can freely zoom in or out while recording video.
8. You can change focus to a different subject or area by just tapping it on the Viewfinder screen.
9. Tap the flash button to switch the camera light on or off during recording.



10. To stop recording, tap  again.
11. Choose what you want to do with the video you've just recorded.



## Adding effects







Want to make your photos look more interesting? Easy. Use the available camera effects to make your photos look like they've been taken through special lenses and filters. You can also add certain effects to videos.

Choose an effect first before you start taking a photo or video.

1. Tap .
2. Scroll through the available effects and tap one that you like.

## After capturing

After capturing a photo or a video, the Review screen shows options on what you could do next.

	Share the photo or video from a variety of options.
	Choose how you want to use the photo, such as by setting it as your wallpaper.
 / 	Take another photo or shoot another video, depending on your current mode.
	Delete the photo or video.
	Go to the Gallery app.
	Add effects to the photo.



Trim the video.

## Camera scenes

Scenes provide an easy way to override your camera's normal settings to suit your current lighting and environment. Use **Auto** and let the camera automatically determine optimal settings, or choose from a wide selection of scenes in the camera settings before you start taking photos and videos.

## Taking a panoramic photo

Whether it's the Golden Gate Bridge or the Eiffel Tower, you can capture anything wide or tall in a single photo.

1. While on the Viewfinder screen, tap **Scenes > Panorama**.



Zooming and flash is disabled when you're in this mode.

2. Point the camera and focus on your subject.
3. When you're ready to take the first frame, tap .
4. Using the dotted line and circles onscreen as guide, pan left or right in landscape view (or pan up or down in portrait view). When the ring reaches and centers on the next circle, the camera automatically takes the shot.
5. Do the same thing to take the last shot, or tap to stop capturing anytime.

Your shots are automatically combined in a single photo.

## Taking continuous camera shots

Is your subject a moving target? The Camera app can catch up.

1. While in the Viewfinder screen, tap **Scenes** > **Action burst**.



Flash is disabled when you're in this mode.

2. Point the camera and focus on your subject.
3. When you're ready to take the photo, tap .

The camera will take five successive shots of your subject.

## Taking a high dynamic range (HDR) photo

Take photos like a pro with HDR imaging. When enabled, HTC ReSound with Beats Audio renders both the bright and dark areas of your subject. The result: better photos with the right image intensity and contrast levels.

1. While on the Viewfinder screen, tap **Scenes** > **Backlight HDR**.



Flash is disabled when you're in this mode.

2. Point the camera and focus on your subject.
3. When you're ready to take the photo, tap . The camera will then process the photo against different light exposure levels to enhance it.

## Changing camera settings

Open the menu panel to access and change camera settings.

To open the camera settings, press MENU .

<b>Self-timer (photo mode only)</b>	Set a time delay before your camera automatically takes the photo.
<b>Image adjustments</b>	Slide your finger across each of the slider bars to adjust the exposure, contrast, saturation, and sharpness.
<b>White balance</b>	White balance enables the camera to capture colors more accurately by adjusting to your current lighting environment.
<b>ISO (photo mode only)</b>	Choose an ISO level or set it back to Auto. Higher ISO numbers are better for taking pictures in low light conditions.
<b>Resolution (photo mode only)</b>	Choose a photo resolution to use.
<b>Review duration</b>	Set the time for a captured photo or video to be displayed on the Review screen before the camera changes back to the Viewfinder screen.
<b>Storage</b>	Choose the storage option to use in saving photos and videos you've captured.

<b>Widescreen (photo mode only)</b>	When this check box is selected (default), photo resolutions available for selection are in 16:9 ratio and you can use the entire Viewfinder screen to frame your subject. When not selected, photo resolutions available for selection are in standard 4:3 ratio.
<b>Geo-tag photos (photo mode only)</b>	Select to store GPS location in your captured photos.
<b>Auto enhance (photo mode only)</b>	Select to reduce noise when using a high ISO setting and to automatically adjust photo brightness.
<b>Auto focus (photo mode only)</b>	Enables or disables centered auto focus.
<b>Face detection (photo mode only)</b>	Select to automatically recognize faces and adjust the focus when you take people photos. Face detection will be turned off if you disable auto focus.
<b>Shutter sound</b>	Select to play a sound when you press the shutter release or record button.
<b>Grid (photo mode only)</b>	Select to display a grid on the Viewfinder screen so you can easily frame and center your subject before taking the photo.
<b>Auto upload (photo mode only)</b>	Lets you automatically upload photos to Facebook or Flickr®. You can set the upload frequency, select the album to upload to, and set the privacy level.

<b>Stereo recording (video mode only)</b>	Select to record sound in stereo when capturing videos.
<b>Record with audio (video mode only)</b>	Select to record audio when capturing videos.
<b>Reset to default</b>	Change the camera settings back to default.

# Photos, videos, and music

## Gallery

---

### About the Gallery app

---

Relive the fun while viewing photos and videos of your latest travels or your pet's newest tricks. Get an audience by tagging your Facebook and Flickr friends. You can even play your media on a TV screen.

**F** To start using Gallery, check first if you have photos or videos copied on HTC Rezound with Beats Audio.

What's more, you can edit and add effects to your photos. You can also easily use a photo as your contact icon, location icon, or wallpaper.

---

### Selecting an album

---

From the Home screen, tap  > **Gallery**. The Gallery app opens on the Albums screen where your photos and videos are organized by albums for easy viewing.

## Viewing photos and videos

After you've selected an album, you can browse through your photos and videos.

Slide your finger up or down to scroll through the thumbnails. Tap a photo or video to view it in full screen.



While viewing a photo in full screen, tap anywhere on the screen, and then tap **More > Show on map** to see the location where you took the photo. (**Show on map** is available when you've enabled Geo-tag photos in Camera.)



## Zooming in or out on a photo

There are two ways you can zoom in or out of a photo.

- Tap the screen twice quickly to zoom in, then tap the screen twice quickly again to zoom out.
- Press your thumb and index finger on the screen and then spread your fingers apart to zoom in; pinch your fingers together to zoom out.



## Viewing photos as a slideshow

1. Select an album that has the photos you want to view as a slideshow.
2. Tap **More > Slideshow**.



- Tap the screen to show the playback controls.
- With the playback controls showing, tap  to set slideshow preferences.

## Watching a video

1. While browsing an album, tap a video to play it.
2. Tap the onscreen controls to control the video playback, share the video on your home network, and more.



Rewind the video playback.



Fast forward the video playback.

**More**

Show more options, such as sound enhancement.



Share the video on your home network.



Adjust the media volume.

---

## Editing your photos

---

Do basic editing tasks on your photos such as rotate and crop. You can also enhance your photos by applying effects such as high contrast, vintage, and more.

### Rotating a photo

1. On the Gallery app's Albums screen, tap an album.
2. Press and hold on the photo that you want to rotate.
3. In the menu that opens, tap **Edit**, and then tap either **Rotate left** or **Rotate right**.

### Cropping a photo

1. On the Gallery app's Albums screen, tap an album.
2. Press and hold on the photo that you want to crop.
3. In the menu that opens, tap **Edit**, and then tap **Crop**. You'll see a crop box around the photo.

4. To adjust the crop box size, press and hold the edge of the box.



5. When directional arrows appear, drag your finger inward or outward to resize the crop box.
6. To move the crop box to the part of the photo that you want to crop, drag the crop box to the desired position.
7. Tap **Save** to keep the changes.

The cropped photo is saved as a copy. The original photo remains unedited.

## Adding effects

1. On the Gallery app's Albums screen, tap an album.
2. Press and hold on the photo that you want to add effects to.
3. In the menu that opens, tap **Edit**, and then tap **Effects**. On the panel that opens, you'll see options available to you.
4. Tap an effect to apply on the photo.
5. Tap **Save** to keep the changes.

The enhanced photo is saved as a copy. The original photo remains unedited.

---

## Trimming a video

---

Remove unwanted scenes from a video you recorded on HTC Rezound with Beats Audio.

1. On the Gallery app's Albums screen, tap an album.
2. Press and hold the video you want to edit, and then tap **Trim**.
3. Drag the two trim sliders approximately to the part where you want the video to begin and end.



As you drag a slider, you'll see time markers and video frames. The one in the middle is your selected frame.

4. Tap  to preview your video.
5. Tap **Done**.

The trimmed video is saved as a new file. The original video remains unedited.

---



## Sending your photos and videos

---

Send photos and videos to your computer or to another device via email, MMS, or Bluetooth.

### Sending photos or videos by email



You can send several photos, videos, or both in an email message. They are added as file attachments in your email.

1. From the Home screen, tap  > **Gallery**.
2. Tap the album that has the photos or videos you want to share.
3. Tap **Share**, and then tap **Gmail** or **Mail**.
4. Select the photos or videos you want to share and then tap **Next**.
5. Compose your message and then tap  (Gmail) or **Send** (Mail).



If you selected **Mail** and you have multiple email accounts, the default email account will be used.

### Sending a photo or video by MMS

1. From the Home screen, tap  > **Gallery**.
2. Tap the album that has the photos or videos you want to share.
3. Tap **Share** > **Messages**.
4. Tap the photo or video you want to send. The photo or video is automatically added into the MMS message.
5. To add another photo or video to your slideshow attachment, tap  and then tap **Picture** or **Video**.

6. Compose your message and then tap **Send**.

### Sending photos or videos using Bluetooth

You can select several photos, videos, or both and send them to someone's device or your computer using Bluetooth.

1. From the Home screen, tap  > **Gallery**.
2. Tap the album that has the photos or videos you want to share.
3. Tap **Share > Bluetooth**.
4. Select the photos or videos you want to share and then tap **Next**.

In the next few steps, you'll be asked to turn on Bluetooth on HTC Rezound with Beats Audio and connect to the receiving Bluetooth device so the files can be sent.

---

## Sharing your photos and videos on the Web

---

Using the Gallery app, you can share photos and videos on your social networks. And you can post videos on YouTube.



You can also use the Camera app to share a photo or video right after you've captured it.

### Sharing photos or videos on Facebook



You need to be logged in to your account to be able to upload photos or videos.

1. From the Home screen, tap  > **Gallery**.
2. Tap the album that has the photos or videos you want to share.
3. Tap **Share > Facebook for HTC Sense**.
4. Select the photos or videos you want to share and then tap **Next**.
5. Select which album to upload to and set privacy settings for the uploaded photos or videos.
6. Tap **Add tag and description**, and then enter a different caption on each photo or video.
7. To tag friends on your photos, tap **Tag this photo**. You can then tap the part where your friend is, and then select who you want to tag from the list. Repeat this step to continue tagging friends.
8. Slide to the left to go to the next photo or video.
9. Tap **Save**.



10. Tap Done.

## Sharing photos and videos on Flickr





You need to be logged in to your Flickr account to be able to upload photos or videos.

1. From the Home screen, tap  > **Gallery**.
2. Tap the album that has the photos or videos you want to share.
3. Tap **Share** > **Flickr**.
4. Select the photos or videos you want to share and then tap **Next**.
5. Select which album to upload to and set privacy settings for the uploaded photos or videos.
6. Tap **Add tag and description**, and then enter a different title and description on each photo or video.
7. To tag friends on your photos, tap **Tag this photo**. You can then tap the part where your friend is, and then select who you want to tag from the list. Repeat this step to continue tagging friends.
8. Slide to the left to go to the next photo or video.
9. Tap **Save**.
10. Tap **Done**.

## Sharing photos on Picasa

**F** You need to be signed in to a Google Account to be able to upload photos to the Picasa™ photo organizing service.

1. From the Home screen, tap  > **Gallery**.
2. Tap the album that has the photos you want to share.
3. Tap **Share** > **Picasa**.
4. Select the photos you want to share and then tap **Next**.
5. Enter a caption for the photos you're uploading.
6. Select the online album where you want to upload the photos, or tap  to create a new album.
7. Tap **Upload**.

## Sharing videos on YouTube

You can share your videos by uploading them to YouTube.

1. From the Home screen, tap  > **Gallery**.
2. Tap the album that has the videos you want to share.
3. Tap **Share** > **YouTube**.
4. Select the videos you want to share and then tap **Next**. Sign in to your YouTube or Google Account, if you're asked to do so.
5. Enter a title for the videos you're uploading.

6. Tap **More details** where you can enter information such as description and tags, and select a privacy option.
7. Tap **Upload**.

---



## Viewing photos in your social networks

---

Right in the Gallery app, check what you and your friends have uploaded to your social networks.



### Viewing photos on Facebook

You need to be logged in to your Facebook account to view Facebook photos.

1. From the Home screen, tap  > **Gallery**.
2. On the top bar, tap  > **Facebook**.
3. Tap your account name or your friend's account on the list to view the photos in the account.

### Viewing photos on Flickr

You need to be logged in to your Flickr account to view Flickr photos.

1. From the Home screen, tap  > **Gallery**.
2. On the top bar, tap  > **Flickr**. You may be asked to give authorization for the app to connect to the Flickr website. If this happens, you need to give authorization to access your Flickr account.

3. Tap your account name or your friend's account on the list to view the photos in the account.

### Commenting on photos in your social networks

Add comments to your uploaded photos as well as your friends' photos.

1. Do one of the following:
  - While browsing online albums, press and hold a photo and then tap **Add comment**.
  - While viewing a photo in full screen, tap anywhere on the screen, and then tap **Comments**.
2. Tap the box that says "Write a comment."
3. Enter your text, and then tap **Comment**.

## Music

---

### Browsing music in the library

---



You need to copy music files to HTC ReSound with Beats Audio first to use the Music app to play music.





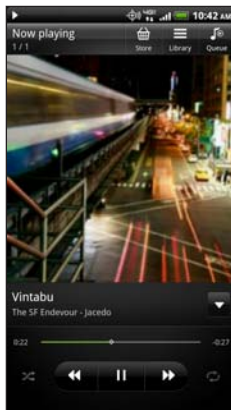

1. From the Home screen, tap  > **Music**.
2. Tap  to browse a category, such as **Artists** or **Albums**.

## Listening to music

Enjoy listening to songs and music on HTC Rezound with Beats Audio using the Music app.

1. While browsing your music collection, tap a song to play it.
2. Tap the onscreen icons to control music playback, repeat songs, and more.



	Go to the library.
	Switch between the player mode or the queue list. You can rearrange songs while in the queue list.
	Press and drag your finger across the progress bar to jump to any part of the song.
	Show options for adding the song to a playlist, sharing the song, and more.
	Turn shuffle on or off. (Shuffle is off when button is gray.)
	Cycle through the repeat modes: repeat all songs, repeat current song, and don't repeat.



Tap  to check out featured albums from V Cast Music.

## Playing music from the Lock screen

When you're listening to music and the screen turns off, press POWER/ LOCK to turn the screen back on and control the music playback directly on the Lock screen.

If you don't see the playback controls on the Lock screen, swipe your finger from left to right on the box onscreen.



You can also pause music playback right from the Notifications panel.

## About the Music widget





You can use the Music widget to play music right from your Home screen.

---



### Creating a playlist

---

Personalize your music experience by creating music playlists. Make a playlist containing just your favorite songs or create one to match your mood for the day. You can make as many playlists as you like.

1. From the Home screen, tap  > **Music**.
2. Tap  > **Playlists**.
3. Tap .
4. Enter a playlist name.
5. To add songs, tap .
6. Tap  to choose a category, and then browse for songs.
7. Select the check boxes of songs you want to add to the playlist and then tap **Add**.
8. Tap **Save**.



### Playing the songs in a playlist



1. From the Home screen, tap  > **Music**.
2. Tap  > **Playlists**.
3. Tap a playlist, and then tap the song you want to play first.

When you tap a song in the list to play it, the Now playing screen is updated with the songs from your playlist.

## Managing playlists

After creating a playlist, you can add more songs to it, rearrange their order, and more.



1. From the Home screen, tap  > **Music**.
2. Tap  > **Playlists**, and then tap the playlist you want to edit.
3. Press MENU , and then tap **Edit playlist**.

Add songs	<ol style="list-style-type: none"> <li>1. Tap .</li> <li>2. Tap  to choose a category, and then browse for songs.</li> <li>3. Select the check boxes of songs you want to add to the playlist and then tap <b>Add</b>.</li> </ol>
Rearrange songs	Press and hold  at the end of the song title you want to move. When the row is highlighted, drag it to its new position, then release.
Delete songs	Select the check boxes of songs you want to remove from the playlist.
Change playlist name	Type the new name of the playlist in the title text box.

4. Tap **Save**.



## Deleting playlists



1. From the Home screen, tap  > Music.
2. Tap  > Playlists.
3. Press MENU  and then tap **Delete playlists**.
4. Select the playlists to delete and then tap **Delete**.

---

## Setting a song as a ringtone

---

You can set a song from the Music app's library as your regular ringtone or as ringtone for a certain contact.

1. From the Home screen, tap  > Music.
2. Browse for the song that you want to set as a ringtone and then play it back.
3. On the Now playing screen, press MENU  and then tap **Set as ringtone** (or **More** > **Set as ringtone**).
4. In the **Set as ringtone** options menu, tap **Phone ringtone** or **Contact ringtone**. If you select **Contact ringtone**, you need to choose the contacts you want to associate the song with in the next screen.

## Trimming an MP3 ringtone

The Music app has a built-in ringtone trimmer. You can trim an MP3 song and set a part of it as your ringtone.

1. On the Now playing screen, press MENU  and then tap **Set as ringtone** (or **More** > **Set as ringtone**).

- In the **Set as ringtone** options menu, tap **Trim the ringtone**.
- Use the onscreen controls to trim your ringtone.



Drag the two trim sliders approximately to the part where you want the ringtone to begin and end.



Tap the left and right arrow buttons to more precisely set the start and end points of the ringtone.



The markers show where the ringtone starts and ends.

- After you've finished trimming, tap **Set as**. Then choose whether to set the trimmed song as your **Phone ringtone** or **Contact ringtone**.

#### Checking if the song was added as a ringtone

- From the Home screen, press **MENU** , and then tap **Settings**.
- On the Settings screen, tap **Sound** > **Phone ringtone**.



The song should be in the ringtone list and selected.

---

## Sharing music using Bluetooth

---

You can choose a song from the Music app's library and send it to someone's device or your computer using Bluetooth.

1. From the Home screen, tap  > **Music**.
2. Browse for the song that you want to send via Bluetooth and then play it back.
3. On the Now playing screen, press MENU  and then tap **Share** (or **More > Share**).
4. Tap **Share file > Bluetooth**.

In the next few steps, you'll be asked to turn on Bluetooth on HTC Rezound with Beats Audio and connect to the receiving Bluetooth device so the music can be sent.

---

## Finding music videos on YouTube

---

You can find music videos of the song you're listening to on YouTube. It's simple. On the Now playing screen, just press MENU  and then tap **Find videos**.

---

## Updating album covers

---

1. On the Now playing screen, press MENU , and then tap **Update album art**.
2. Choose whether to automatically or manually update all album covers or update just the current song on the Now playing screen.

## Connected Media

---

### Sharing media on your home network

---



Share photos, videos, and music with a bigger circle of friends on your home network. Simply connect your phone to the network and instantly show your captured photos and videos on a big TV, or start streaming your favorite music tracks on hi-fi speakers — all via DLNA®. For more information about DLNA, visit [www.dlna.org](http://www.dlna.org).

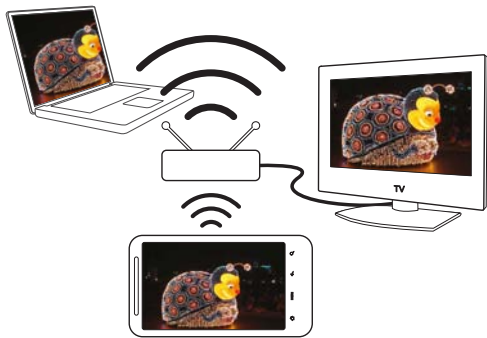

Before you share media through the network:

- Connect your phone to the network via Wi-Fi.
- Connect the TV or speakers to the network. Check the documentation that came with your TV or speakers to know how.



1. Open the Gallery or Music app.
2. Locate the media that you want to share, and then tap it.
3. While viewing the photo or playing the video, tap on the screen to show the playback controls, and then tap . Or if you're playing music, press MENU  and then tap **Output**.
4. Choose the device on your network where you want to play the media.
5. Once connected to the other device, you can tap:

Controls	To
	Play the media on the other device.
	Pause the media playback.
	Play the previous media track.
	Play the next media track.
More	Show more options, such as viewing the media details.
	Shuffle your music playlist.
	Select a repeat mode for music tracks.
	Adjust the media volume on the other device.
	Connect to another photo/video player on the network.

Controls To



Disconnect your phone from the other device.



While playing media on another device, you can press BACK ← and do other things on HTC Rezound with Beats Audio.

# HTC services

## HTC Watch

---

### About HTC Watch

---



With the HTC Watch™ online video service, get a glimpse of the latest movie trailers and enjoy watching Hollywood blockbusters or TV shows. Create your HTC Watch account so you can:

- Rent or purchase videos such as movies and TV shows online.
- Recommend videos instantly to your family and friends.
- Watch your purchased videos on up to five HTC devices that have access to HTC Watch using your same account.

---

### Creating or signing in to your HTC Watch account

---

1. From the Home screen, tap  > **Watch**.  
If this is your first time to use the service, read and accept the license agreement before you continue.
2. Tap , and then go to the All videos tab.
3. Tap the **Tap to sign in to Watch** button and then tap **Next**.
4. Create a new HTC Watch account, or directly sign in if you already have your account.



You can also go to **Settings > Accounts & sync** to create your HTC Watch account.

## The Watch app

On the Watch app's main screen, you'll see the preloaded content. When you download movies and TV shows from the HTC Watch video store, they will also appear on this screen.

From the Home screen, tap  > **Watch**.

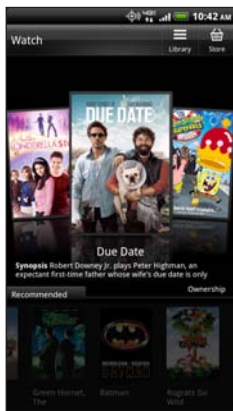

- Swipe left or right across the screen to browse through the videos, and then tap one to watch it.
- Tap **Recommended** to check what recent releases or seasonal TV shows are available in the store.
- From the main screen, you can also go to the HTC Watch video store or access your library to manage your downloads.





You can connect HTC Rezound with Beats Audio to an HDTV that has HDMI and enjoy watching the preloaded movie, your rented videos, and purchased videos on the big screen. You'll need to use a supported MHL-HDMI adapter and HDMI cable (sold separately) to connect HTC Rezound with Beats Audio to the TV's HDMI port.

---

## Browsing the video store selections

---

Explore the catalogue of items in the HTC Watch video store. Browse TV shows and movies available for rent or purchase. You can also view trailers for select videos.

1. From the Watch main screen, tap .
2. Browse the recommended and featured selections, or browse by category.



To do a quick search, press SEARCH  and then enter a title that you're looking for.

3. Tap a video to view its synopsis.

Rent or make a purchase when you're ready.

### Watching a trailer

If you see the  icon while viewing the synopsis of a video, that means there's a trailer available for that video. Tap it to watch the trailer.

## Recommending a video

While viewing the synopsis of a video, you can easily recommend the video to your family or friends by sharing its link. You can send it in an email, post to your social network, or share in other ways.



Tap  and then choose how you want to share the link.

---

## Renting or purchasing a video

---

Your billing information will be stored on your HTC Watch account so you won't need to enter it every time you rent or purchase.

1. While viewing the synopsis of a video, tap  to rent or  to purchase the video.  
Or while browsing the video selections, tap the respective buttons to rent or purchase a video.
2. If this is your first time to rent or purchase, tap **Add a payment card** and then enter your credit card details and billing address.

 Make sure to use a credit card that's registered in the same region as the one associated to your HTC Watch account.

3. Confirm your rental or purchase.
4. Tap **Download**.

You can go to your library to check your downloads.

---

## Managing your library

---

Use the library to manage your downloads and see all of your purchases. From the library, you can also start watching a video as it's being downloaded.

From the Watch main screen, tap  to access your library.

The library organizes your downloads as follows:



### Downloaded

Lists videos that have been fully downloaded to your current HTC device.



### All videos

Lists all videos that you have rented or purchased and allows you to manage your downloads. You can pause a download, resume it, or redownload a video.



### Progress

Shows you the download progress of videos. You can tap a video to start watching it as it's being downloaded,

When the download is complete, they will appear in the Downloaded videos tab and also on the Watch main screen.

---

## Checking or changing settings

---

In the Watch app, press MENU , and then tap **Settings**.

### Account

Modify your account settings.

<b>Update widget when opened</b>	Select or clear this check box, depending on whether you'd like the Watch widget to auto refresh.
<b>My purchases</b>	Check your purchase history.
<b>Payment methods</b>	Edit or delete your credit card information.
<b>Device management</b>	<p>When you download videos from the video store, your HTC device will automatically be added to your HTC Watch account. If you own more than one HTC device that has access to HTC Watch, you can download and watch videos on up to five devices.</p> <p>Tap <b>Remove device</b> if you want to unlink and remove an HTC device from your account.</p>
<b>Re-check store region</b>	If you travel to a different region, you can make the app redetect your location to determine the video store region from which you can rent or purchase videos.

---

## Some useful things to know

---

### Why am I asked to sign in again to my account?

Whenever a time interval (about 20 minutes) has passed, you'll be asked again to sign in to your HTC Watch account before you can continue to rent or purchase videos or access some settings. This is a safety precaution to check your identity and to ensure that you acknowledge that it is your account.

### How long is the rental period of a video?

Depending on the studio's terms and the country where you downloaded the video, the rental period is either 24 or 48 hours, starting from the first viewing.

If you're not immediately watching the video, you have up to 30 days before the rental expires.

### Why won't HTC Watch allow me to remove a device and add a new one?

Removal is available once every 120 days when you've already reached the maximum of five HTC devices in your account.

### How do I remove my HTC Watch account from my device?

1. In the Watch app, press MENU  and then tap **Settings > Account**.
2. Tap **Remove account**.

You can also go to **Settings > Accounts & sync** to remove your HTC Watch account.

# Accounts and sync

## About online accounts

HTC Rezound with Beats Audio can sync with popular online social networking and email accounts.

The information you can get includes:

- Gmail, Exchange ActiveSync, and other POP3/IMAP email.
- Google and Exchange ActiveSync contacts, as well as your friends' contact information in Facebook and their Twitter profiles.
- Calendar events from your Google Account(s), from Exchange ActiveSync, and from your Facebook account.
- Status updates and links shared by your friends and yourself on social networks such as Facebook and Twitter.
- Flickr and Facebook photo uploads.



You can set up your Exchange ActiveSync and POP3/IMAP email accounts on HTC Rezound with Beats Audio either in the Mail app or the Accounts & sync settings.

## Synchronizing with a Google Account

Signing in to your Google Account lets you sync Gmail and your Google contacts and calendars between HTC Rezound with Beats Audio and the Web. You also need to sign in to a Google Account to use Google apps such as Google Talk and Android Market.



If you skipped adding a Google Account when you first set up HTC Rezound with Beats Audio, you may encounter problems when using some Google apps. If these problems persist, you may need to factory reset HTC Rezound with Beats Audio and enter your Google Account details when you set up HTC Rezound with Beats Audio again. Remember that you will lose data when you factory reset your wireless device.

---

### Adding more Google Accounts

---

You can add more than one Google Account. However, subsequent Google Accounts can only sync contacts, emails, and calendar events. Other Google services use the first Google Account you added.

1. From the Home screen, press MENU , and then tap **Settings > Accounts & sync**.
2. Tap **Add account > Google**.
3. Follow the onscreen instructions to sign in to an account or create a new account.

## Forgot your Google Account password?

If you have forgotten your Google Account password, you can try to recover it by going to the Google website.

1. On HTC Rezound with Beats Audio or on your computer, open your web browser and go to [www.google.com/accounts/recovery](http://www.google.com/accounts/recovery).
2. Enter the email address or username that you use to sign in to your Google Account and click **Submit**.
3. Follow the instructions on the screen to reset your password.

If you don't have an alternate email address or cannot access the email account you used to create your Google Account, you can reset your Google Account after 24 hours by answering the security question for password recovery.

## Adding a social network account

Skipped signing in to your social network accounts (such as Facebook, Twitter, or Flickr) when you first turned on and set up HTC Rezound with Beats Audio? You can still add these accounts.

1. From the Home screen, press MENU , and then tap **Settings** > **Accounts & sync**.



2. Tap **Add account**, and then tap the account type you want to add.
3. Follow the onscreen instructions to enter the account information.

Your social network account is then added to the list on the Accounts & sync screen. Depending on how you configured the account, the new information may start synchronizing with HTC Rezound with Beats Audio.

## Managing your online accounts

---

### Changing general sync settings

---

1. From the Home screen, press MENU , and then tap **Settings > Accounts & sync**.
2. Select or clear the following:

<b>Background data</b>	If this is selected, apps can send and receive online account information even if you are not currently using them.
<b>Auto-sync</b>	If this is selected, apps can use the sync schedule defined in the account settings. If this is cleared, you will need to sync accounts manually.

---

### Synchronizing an account manually

---

1. From the Home screen, press MENU , and then tap **Settings > Accounts & sync**.

2. Tap the account that you want to sync.
3. Tap **Sync now**.

---

## Changing account settings

---

You can change settings such as the sync frequency and the types of information synchronized, the kinds of notification you receive, and the way that account information is displayed.

1. From the Home screen, press MENU , and then tap **Settings > Accounts & sync**.
2. On the Accounts & sync screen, tap the account that you want to edit.
3. Tap the type of information you want to sync or select an item to edit its settings.

---

## Removing an account

---

You can remove an account to delete it and all information associated with it from HTC Rezound with Beats Audio, for example email, contacts, or settings. Removing an account does not delete information from the online service itself.



You cannot remove some accounts, such as the first Google account you signed into, except by deleting all personal information from HTC Rezound with Beats Audio with a hard reset. Remember that you will lose data when you hard reset your wireless device.

1. From the Home screen, press MENU , and then tap **Settings > Accounts & sync**.
2. Tap the account that you want to remove.
3. Tap **Remove account**, and then confirm that you want to remove the account.

# People

## About the People app

With the People app, easily manage your communications with your contacts via phone, messaging, and email. You can also link your contacts to their social network accounts like Facebook and Twitter to see their updates and events from these accounts all in one place.

And that's not all. If you have the same contacts from different sources, People lets you merge their contact information so you won't have duplicate entries in your contacts list.

1. From the Home screen, tap  > **People**.
2. Tap one of the following tabs:



### Phone

Launches the Phone dialer screen.



### People

Gives you access to all contacts on HTC Rezound with Beats Audio, online accounts, and more.



### Groups

Lets you assign contacts to groups so you can easily send an SMS, MMS, or email message to a whole group.



## Call History

Lists all your dialed numbers and received and missed calls.



## Your contacts list

The People app lists all contacts stored on HTC Rezound with Beats Audio and from the online accounts you're logged in to. When you open People after you've just logged in to a new account, you'll be asked whether to add contacts from that account to your contacts list.

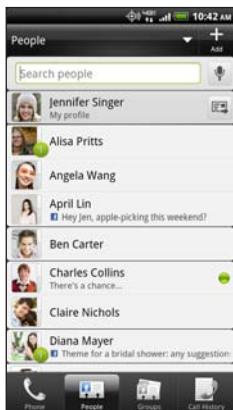
Your contacts list also displays the contacts stored on your SIM card (usually marked with the SIM card icon ).



You can:





- Open your profile and edit your own contact information.
- Create, edit, or find contacts.
- See status updates from friends in your social network accounts such as Facebook and Twitter.
- Tap a contact's name to open the contact details screen for that contact.
- See a notification icon such as  when a contact has sent you new messages or when it's the contact's birthday.
- Check out who's online in Google Talk. Online status icons are displayed if you're signed in to Google Talk on HTC Rezound with Beats Audio. For example,  means the contact is available to chat.

---

## Filtering your contacts list

---

You can choose to only display contacts from particular account types (for example, Google contacts or Facebook contacts).

1. From the Home screen, tap  > **People**.
2. On the People tab, tap  on the top bar to show a list of your online accounts.
3. Choose the online accounts that contain the contacts you want to display in your contacts list, and then press **BACK**  to save your selection.
4. To set more options on sorting your contacts, press **MENU**  and then tap **Settings**.

## Setting up your profile

Store your personal contact information to easily send it to other people.

1. From the Home screen, tap  > **People**.
2. Do one of the following:
  - If you're logged in to any of your online accounts such as your Google Account or Facebook for HTC Sense, tap your name or email address, and then tap **Edit my contact card**.
  - If you're not logged in to your online accounts, tap **Me**, and then choose whether to link your profile to an existing contact entry that already contains your personal information or edit your profile.

3. Enter or edit your name and contact details.
4. Tap  or your photo, and then choose whether to take your self-portrait or use another photo for your profile.
5. Tap **Save**.

---

## What you can see on your profile

---

When you tap **My profile**, you'll see the following tabs:



### Details

Shows your own contact details. You'll also see your most recent posts in social networks such as Facebook and Twitter (if you're signed in to Facebook and Twitter for HTC Sense).

From this tab, you can edit your profile or share it with others.



### Updates and events

Shows the updates and events that you've posted in your social networks such as Facebook, Twitter, and Flickr.





### Gallery

Shows your Facebook and Flickr albums and photos.





## Importing contacts from your SIM card

When you import SIM contacts, you can either store them on HTC Rezound with Beats Audio or add them to your Google contacts or Exchange ActiveSync contacts, if you have set up the relevant accounts.

1. From the Home screen, tap  > **People**.
2. Press MENU , and then tap **Import/Export** > **Import from SIM card**.
3. If you have Google or Exchange ActiveSync accounts set up on HTC Rezound with Beats Audio, tap the type for the imported contacts.
4. Do one of the following:
  - Tap one or more SIM contacts you want to import.
  - To import all contacts, tap **Select all**.
5. Tap **Save**.

## Adding a new contact

1. From the Home screen, tap  > **People**.
2. Tap .
3. Tap the **Name** field, and then enter the contact name.



Tap  if you want to separately enter the contact's first, middle, and last name. Depending on the contact type, you may also be able to add a name prefix (such as Mr. or Ms.) or a name suffix (such as Ph.D., Jr, or Sr).

4. Select the Contact type, for example Google or Exchange ActiveSync. This determines which account the contact will sync with.





Some fields may not be available when you're adding contacts to your SIM card.

5. Enter the contact information in the fields provided.  
Press BACK  if you want to close the onscreen keyboard first and easily scroll through the other fields.
6. Tap **Save**.

## Searching for contacts

In addition to searching contacts by name or email address, you can set the People app to search by other criteria such as by their group name or company.



1. From the Home screen, tap  > **People**.
2. Press MENU , and then tap **Settings** > **Search contacts by**.
3. Choose the types of criteria to search for, and then tap **Done**.

When performing your search, simply enter the first few characters of the item you're looking for in the search box. Matching contacts will then be listed.

## Importing a contact from an Exchange ActiveSync account

You can search for a work contact from your Exchange ActiveSync account, and then copy it on HTC Rezound with Beats Audio.

You need to have your Exchange ActiveSync account set up on HTC Rezound with Beats Audio first.

1. From the Home screen, tap  > **People**.
2. In the search box, enter the first few letters of the contact's name or email address.
3. Tap . Under Company contacts, matching names are listed.
4. Tap the name of the contact you want copied on HTC Rezound with Beats Audio, and then tap **Save to People**.

## Merging contact information

If you have the same contacts on HTC Rezound with Beats Audio, Google Account, and social network accounts such as Facebook and Twitter, HTC Rezound with Beats Audio will try to combine them automatically or let you decide which contacts to combine. Combining the same contacts avoids duplicate entries in your contacts list.

---

### Accepting matched contacts suggestions

---

When HTC Rezound with Beats Audio finds contacts that can be merged, you'll see a link icon  in the notifications area of the status bar.

1. Slide the Notifications panel down, and then tap **Matched contacts suggestion**. You'll see a list of suggested contacts to merge.

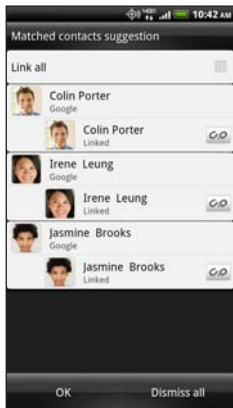

2. To merge, tap .
3. Tap OK.





If you don't want to merge any of your contacts, tap **Dismiss all**.

---

## Viewing a list of all your linked contacts





---

1. From the Home screen, tap  > **People**.
2. Press MENU , and then tap **Linked contacts** (or **More > Linked contacts**). The All linked contacts screen then opens where you can see the account types and information merged.
3. You can choose to break the link of an account type or relink.
4. When you're done, tap OK.

---

## Manually merging contact information



---

1. From the Home screen, tap  > **People**.
2. Tap the name of the contact (not the icon or photo) you want to link.
3. Tap  or  (if there are suggested links).
4. You can:
  - Under **Suggest links**, tap  to link the contact to an account.
  - Under **Add contact**, tap one of the options to link to another contact.



---

## Breaking the link

---

1. From the Home screen, tap  > **People**.
2. Tap the name of the contact (not the icon or photo) whose link you want to break.
3. Tap .
4. Under the **Linked contacts** section, tap  beside an account type to break the link.

## Backing up your contacts to the storage card



1. From the Home screen, tap  > **People**.
2. Press MENU , and then tap **Import/Export** > **Export to SD card**.
3. Select an account or type of contacts to export, then tap **OK**.

---

## Importing contacts from the storage card

---

You can only import contacts that were exported to the storage card using the **Export to SD card** feature.

1. From the Home screen, tap  > **People**.
2. Press MENU , and then tap **Import/Export** > **Import from SD card**.
3. If you have Google or Exchange ActiveSync accounts set up on HTC Rezound with Beats Audio, tap the type for the imported contacts.

## Contact information and conversations

When you tap a contact on the People screen, the contact details screen opens, showing you the information you've stored or linked for that contact.

The contact details screen has the following tabs:



### Details

Shows the information you have stored for the contact. Get in touch with the contact directly by tapping any of the displayed methods. For example, if the contact has a stored work phone number, tap **Call work**.



### Thread

Shows SMS messages and emails you've received from the contact. It also lists all your incoming, outgoing, and missed calls to and from the contact.

From this tab, you can reply to a message, send an email, or call the contact.



### Updates

Shows the contact's updates and events from social network accounts you've linked like Facebook, Twitter, and Flickr.

If you see a notification of the contact's birthday under the Events section, you can tap the notification and choose how you want to greet your contact, such as to write on the person's Facebook wall.



## Gallery

Shows the linked contact's Facebook and Flickr albums and photos.

---

## Editing a contact's information

---

1. From the Home screen, tap  > **People**.
2. Press and hold the contact, and then tap **Edit contact**.





The contact details of your Facebook and Twitter contacts cannot be edited.

3. Enter the new information for the contact.
4. Tap **Save**.

---

## Deleting contacts

---

1. From the Home screen, tap  > **People**.
2. Press MENU , and then tap **Delete**.
3. Select the contacts you want to remove, and then tap **Delete**.
4. When prompted, tap **OK**.



## Sending contact information as a vCard

Easily share with others your own contact information or any contact from HTC Rezound with Beats Audio.

1. From the Home screen, tap  > **People**.
2. Do the any of the following:

To send	Do this
Someone's contact information	Press and hold the name of the contact (not the icon or photo) whose contact information you want to send, and then tap <b>Send contact as vCard</b> .
Your contact information	Press and hold <b>My profile</b> , and then tap <b>Send my profile</b> .



3. From the available options, choose how you want to send the vCard.
4. Select the type of information you want to send, and then tap **Send**.

---

## Sending multiple contact cards

---

Easily share with others the contact information of several contacts from your HTC Rezound with Beats Audio.

1. From the Home screen, tap  > **People**.
2. Press MENU , and then tap **More** > **Send contacts**.

3. Select the contacts whose contact information you want to share, and then tap **Send**.



If you can't see the **Send** button while the onscreen keyboard is open, press **BACK** ← to close the keyboard.

4. Choose how you want to send the contact cards:

**Bluetooth** Tap **Scan for devices**, and then tap the device to which you want to send the contact cards. Follow the onscreen messages on HTC Rezound with Beats Audio and the other device to pair them and send the files.

**Mail** Compose and send your email message, with the contact cards attached.



## Contact groups

Assign contacts to groups so you can easily send a message or email to a whole group. You can also sync groups on HTC Rezound with Beats Audio with the groups in your Google account, accessible via your computer's web browser. We've also added the Frequent group as a special group type that automatically stores the contacts you dial or get calls from the most.

---

### Creating a group

---

1. From the Home screen, tap  > **People**.
2. On the Groups tab, tap .

3. Enter a name for the group, and then tap .
4. Select the contacts you want to add to the group, and then tap **Save**.





If your contacts list is long, you can use the search bar to search for contacts quickly, or press **BACK**  to hide the onscreen keyboard and scroll through the list.

5. Tap  to select a photo for the group.
6. Tap **Save**.

---

## Editing a contact group

---

1. From the Home screen, tap  > **People**.
2. On the Group tab, press and hold the group, and then tap **Edit group**.
3. You can:
  - Tap the group name to change the name. You can only change the name for groups that you have created.
  - Tap the icon to the left of the group name to change or remove the group photo.
  - To add contacts to the group, tap , select the contacts you want to add, and then tap **Save**.
  - To remove a contact from the group, tap the box beside the contact name.
4. Tap **Save**.

---

## Sending a message or email to a group

---





You will be charged for each message sent. For example, if you send a message to a group of five people, you will be charged for five messages.

1. From the Home screen, tap  > **People**.
2. On the Group tab, tap the group you want to send a message or email to.
3. Go to the Group action tab, and then do one of the following:
  - Tap **Send group message** to send a message to the group.
  - Tap **Send group mail** to send an email to the group.

---

## Rearranging your contact groups

---

1. From the Home screen, tap  > **People**.
2. On the Groups tab, press MENU , and then tap **Edit group**.
3. Press and hold  at the end of the group you want to move. When the row is highlighted, drag it to its new position.





4. Tap **Save**.

---

## Rearranging the members of a contact group

---

1. From the Home screen, tap  > **People**.
2. On the Groups tab, tap the group to see its members.
3. Press **MENU** , and then tap **Edit group**.
4. Press and hold  at the end of the contact's name you want to move. When the row is highlighted, drag it to its new position.
5. Tap **Save**.



---

## Deleting groups

---



You can only delete groups that you have created.

1. From the Home screen, tap  > **People**.
2. On the Groups tab, you can:
  - Press and hold a group you want to delete, and then tap **Delete group**.
  - Press **MENU**  and then tap **Delete groups** to choose several contact groups to remove.

## Adding People widgets

Stay in touch with different circles of friends or colleagues in your life. You can add several People widgets on the Home screen, with a different group of contacts on each widget.



1. From the Home screen, tap  > Widget > People.
2. Choose the widget style, and then tap Select.
3. Select the group you want to add as a widget.
4. Repeat the above steps to add another People widget.

---

## Setting the default communication method

---

Depending on how you often reach your contacts, you can choose a different communication method for each of the contacts on the People widget.

1. On the Home screen, go to the People widget.
2. Tap a contact's name or status update (not the photo) on the widget to open the person's contact details screen.
3. Tap **Set default action**, and then tap the communication method you want for the contact.
4. Press BACK  to return to the People widget on the Home screen.

---

## Changing the default communication method

---

1. On the Home screen, go to the People widget.
2. Tap a contact's name or status update on the widget to open the person's contact details screen.
3. Tap **Set default action**.
4. On the Select default action screen, tap the communication method you want for the contact.
5. Press BACK  to return to the People widget on the Home screen.

---

## Getting in touch with a contact

---

1. On the Home screen, go to the People widget.

2. Tap a contact's photo (not the name or status update) on the widget. The default communication method you've set for this contact will be performed.



On the People widget:



- Tap a contact's name or status update to open the contact details screen for that contact.
- Tap  to open the People app and view all your contacts.

---

### Adding group members to a People widget

---

You can add more members to the contact group that's on a People widget.

- To add just one member, tap .
- To add several members, tap .



# Social

## Facebook for HTC Sense

With Facebook for HTC Sense, you can:

- See all your Facebook contacts and their instant status updates in People.

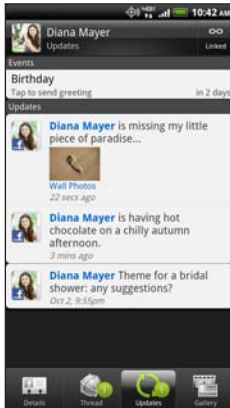

When you tap a contact in People, slide to the Updates tab to see updates such as posted status messages, uploads, and profile changes.

When there is a notification of the contact's birthday, you can tap the notification to send a greeting.

- See Facebook photos right on the Gallery app.



You can also upload one or more photos to Facebook, then tag and add captions that go with it.

When you're viewing the albums of a Facebook friend, you can also share a link to a particular album, or comment on the album photos.

- Check your friends' Facebook status updates in Friend Stream™.
- View your Facebook events and your friends' birthdays on the Calendar app.





- Signing in to your Facebook account from the Accounts & sync settings or the Facebook app (preinstalled or downloaded from Android Market) automatically signs you in to Facebook for HTC Sense.
- You may need to authorize Facebook for HTC Sense to connect to your Facebook account.

## Using Facebook chat

Chat with your Facebook friends right from HTC Rezound with Beats Audio.



You must be signed in to Facebook before using Facebook chat.

1. From the Home screen, tap  > **Fb Chat**. The Facebook chat screen opens where current conversations with your Facebook friends are shown, along with friend groups.
2. Do any of the following:
  - Tap the name of a friend to continue the conversation.
  - Tap the photo of a friend to view the person's Facebook profile, wall, and uploads.
  - Tap the History tab to view a list of previous conversations. The number on the tab icon shows how many messages are unread.
  - Press MENU , and then tap **Settings** to choose to hide offline friends and select notification settings.

---

### Adding the Facebook chat widget

---

Add the Facebook chat widget to the Home screen so you can easily chat with your Facebook friends.

## Twitter for HTC Sense

When you're signed in to Twitter for HTC Sense, you can:

- See your Twitter contacts and their latest tweets in People.
- Send tweets and check your friends' tweets in Friend Stream.



If you have the Twitter app (preinstalled or downloaded from Android Market), signing in to Twitter for HTC Sense does not sign you in to the Twitter app and vice versa. These two don't share the same login credentials. If you want to use the same Twitter account for both, you'll have to sign in to both using the same login credentials.

## Using Friend Stream

Friend Stream connects you to your social networks. Share and get updates from friends in popular networks like Facebook and Twitter in a single feed. With Friend Stream, you can easily track your friends' status messages, photo uploads, notifications, and more — or comment and post your own.



You must be signed in to at least one social network account to use Friend Stream.

From the Home screen, tap  > **Friend Stream**. Friend Stream opens on the All updates tab.

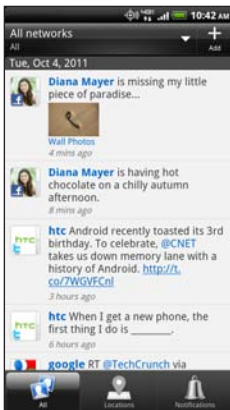



When you tap someone's status update, you can:

- View the tweet. If there's a web link shared, you'll also see the posted web page right below the tweet.
- Write a comment. Like someone's Facebook posts.
- Look at someone's album photos.

When you tap someone's photo or name, you can:

- Check the person's profile details.
- Look at the person's Facebook wall.
- Check the person's posted tweets.

Tap  to display posts from a particular social network.

Slide to the other tabs to see more options. You can press MENU , and then tap **Settings > Edit tabs** to customize the Friend Stream tabs.



---

## Updating your status

---

You can update your status simultaneously on all the social network accounts you are signed in to.

1. On the All or Notifications tab, tap .
2. Enter your status update.

3. If you do not want to send the status update to all your social network accounts, tap  and clear the check boxes of the social networks to exclude.
4. Tap Done.
5. Tap , and then choose what you want to attach to your tweet or status update.
6. Tap Post.

---

## Checking notifications from your social networks

---

Slide to the Notifications tab to easily see a single feed of your notifications from different social networks. It can be a comment on your Facebook post, a mention or direct message in Twitter, a tagged photo of you, and more.

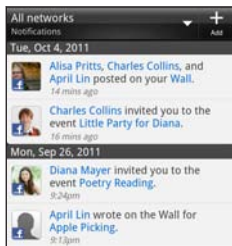

---

## Viewing your lists of friends and social groups

---

1. On the All updates tab, press MENU , and then tap Friends.
2. Tap  to select a social network to display.

3. Scroll through your list of friends, or slide your finger across the bottom tabs to see different lists and groups.

---

### About the Friend Stream widget

---

Use the Friend Stream widget so you can easily update your status and view other people's status updates right on the Home screen. If you want to keep up with just one person's Facebook updates, you can add the Friend Channel widget. You can find it in the Friend Stream widget layout options.

### Enjoying Facebook in Friend Stream



Post your status updates, write messages on your friends' Facebook walls, or share your location with your social network.

---

### Posting a message on a friend's Facebook wall

---

Quickly write a wall post to your Facebook friends in Friend Stream.

1. In Friend Stream, tap  > **Facebook**.
2. Tap  > **My wall**, and then tap a friend from the list.
3. Enter your message.
4. Tap  to attach a photo.
5. Tap **Post**.

## Commenting on and liking Facebook posts

Tap someone's status update on the All updates tab, and do any of the following:





- Tap a photo or the album name shown in the status update to view and comment on the album photos using the Gallery app.
- Tap **Like** to like the person's status update.
- Tap the text box, and then enter what you think about the person's status update.

## Sharing your location with your Facebook friends

Eating out in your fave restaurant? Tell your friends where you are and invite them along.







- You must be signed in to Facebook for HTC Sense to use this feature in Friend Stream.
- In order to find your location, you also need to enable location sources in **Settings > Location**.

1. Go to the Locations tab, and then tap .
2. Do any of the following:
  - Tap a place from the list.
  - Tap , type in your current location name and description, and then tap **Done**.



3. Tap **Check in**.
4. On the next screen, you can add your status message and even tag the friends you're with.
5. When done, tap **Check in**.

## Tweeting in Friend Stream

1. In Friend Stream, tap  > **Twitter**.
2. Tap , and then type in your tweet.
3. Add a picture or location to your tweet.
  - Tap  to post a picture from Gallery or Camera to your default photo hosting site and add the link to the picture in your tweet.
  - Tap  to include your current location info in your tweet.
4. Tap **Post**.

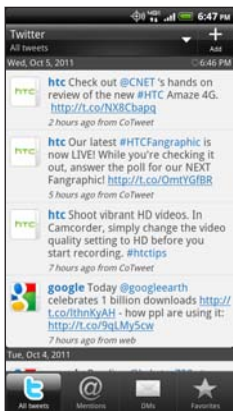

Tap a person's name to check profile details and all of his or her tweets.



If you have linked the contact in People, tap the photo or icon to open a menu where you can quickly choose how to communicate with the contact.

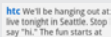

htc We'll be hanging out at live tonight in Seattle. Stop say "hi." The fun starts at

Press and hold a tweet to open an options menu to reply, send a direct message, retweet, and more.



View all the tweets from people you follow and tweets that you have posted.



View all tweets that mention your username using the “@[your username]” convention.





View all private/direct messages that you have received or sent.



View tweets that you have marked as favorites.

## Searching for Twitter users to follow

1. In any of the tabs, press the SEARCH button.
2. Type a Twitter name in the search box. You can also narrow down the search when you tap > Users.

3. Tap .
4. In the list of search results, tap the Twitter user you want to follow.
5. Press MENU , and then tap **Follow**.

### Unfollowing a Twitter user

1. On the All tweets tab, tap the Twitter user you want to stop following.
2. Press MENU , and then tap **Unfollow**.

---

### Sending a direct message

---

You can only send a direct message (DM) to someone who is following you.

1. On the DMs tab, tap .
2. Enter the name of a Twitter users in the **To** field. As you enter characters, matching results appear on the screen. Tap the name when you see it.
3. Enter your message, and then tap **Post**.

You can also send a direct message when you press and hold a tweet of the person you want to send the direct message to, and then tap **Send direct message** on the options menu.

## Chatting in Google Talk



Google Talk is Google's instant messaging program. It lets you communicate with other people that also use Google Talk. If you signed in to your Google Account when you first set up HTC Rezound with Beats Audio, you are already signed in to Google Talk.

To open Google Talk, on the Home screen tap  > **Talk**.

---

### Chatting with a friend

---

1. In Google Talk, tap a friend in the Friends list.
2. Enter your message in the text box. You can also insert a smiley by pressing MENU , and then tapping **More** > **Insert smiley**.
3. Tap **Send**.
4. While chatting, press MENU  and then tap any of these options:

<b>Chat off record</b>	Your Google Talk messages are stored in the <b>Chats</b> folder of your Gmail account. Tap this option if you don't want to store your chat messages.
<b>Switch chats</b>	If you have more than one chat going, tap to switch chat with another friend.
<b>Friends list</b>	Return to the Friends list.
<b>Add to chat</b>	Add another friend to your chat. The friend you invited and the friend you're currently chatting will receive an invitation to a group chat. Each one who accepts the invitation joins the group chat.

<b>End chat</b>	End your current chat.
<b>More</b>	Clear the chat history, insert a smiley or view your friend's contact details.



---

## Chatting by voice or video

---

If your friends use Google Talk on a device with a microphone or camera, you can chat with them by voice or video.

**F** Set your online status to be available for voice or video chats. Tap your profile in the Friends list, and then select the **Allow video and voice chats** option.

1. In the Friends list, do one of the following:
  - Tap  beside your friend's name to start a voice chat.
  - Tap  to start a video chat.
2. During a video chat, you can:
  - Tap the screen to reveal the onscreen chat controls.
  - Press VOLUME UP and VOLUME DOWN to adjust the volume level.
3. When you're done with the voice or video chat, tap X.

---

## Accepting a chat invitation

---

When a friend sends you a Google Talk message, you receive a notification. Their entry in the Friends list displays the message.

Do one of the following:

- In the Friends list, tap the friend who sent you the invitation to chat.
- Open the Notifications panel, and then tap the chat notification.

---

## Changing your online status and picture

---

1. In Google Talk's Friends list, tap your name to open the Set Status screen.
2. Enter your new status message. Or press BACK  to choose a custom status from the list.
3. Tap the online status beside your picture, and then select the status you want on the menu.
4. Tap your picture, and then do one of the following:
  - Tap **Remove** to remove your photo.
  - Tap **Change** to select another picture.
5. Tap **Done**.

Your online status, message, and picture appear in your contacts' Friends list and in other apps where your Google Talk status are displayed.

---

## Adding and managing friends



---

The Friends list is where you add and manage your friends in Google Talk. In Google Talk's Friends list, you can:

### Invite a friend

1. Press MENU , and then tap **Add friend**.
2. Enter the Google Talk instant messaging ID or Gmail address of the friend you want to add.
3. Tap **Send invitation**.

### View all friends

Initially, only those friends that you often chat with — the most popular — are shown in the Friends list. To view all your friends, press MENU , and then tap **All friends**. To view only friends that you often chat with, press MENU , and then tap **Most popular**.



### Make a friend popular

1. Press MENU , and then tap **All friends**.
2. Press and hold a friend's name, and then tap **Always show friend**.

### Block a friend

You can block a friend from sending you messages. When blocked, your friend is removed from the Friends list and is added to the Blocked friends list.

1. Press MENU , and then tap **All friends**.
2. Press and hold a friend's name, and then tap **Block friend**.

<b>Unblock a friend</b>	<ol style="list-style-type: none"><li>1. Press MENU , and then tap <b>More &gt; Blocked</b>.</li><li>2. Tap the friend you want to unblock and then tap <b>OK</b>.</li></ol>
<b>View all invited friends</b>	Press MENU  , and then tap <b>More &gt; Invites</b> . Friends who have not yet accepted your invitation are listed on the screen.

---

## Changing settings or signing out

---

In Google Talk's Friends list, press MENU  and then tap:

- **Settings** to change the app and notification settings.
- **Sign out** to sign out.

## Using Facebook chat

Chat with your Facebook friends right from HTC Rezound with Beats Audio.



You must be signed in to Facebook before using Facebook chat.

1. From the Home screen, tap  > **Fb Chat**. The Facebook chat screen opens where current conversations with your Facebook friends are shown, along with friend groups.
2. Do any of the following:
  - Tap the name of a friend to continue the conversation.



- Tap the photo of a friend to view the person's Facebook profile, wall, and uploads.
- Tap the History tab to view a list of previous conversations. The number on the tab icon shows how many messages are unread.
- Press MENU , and then tap **Settings** to choose to hide offline friends and select notification settings.

---

### Adding the Facebook chat widget

---

Add the Facebook chat widget to the Home screen so you can easily chat with your Facebook friends.

# Email

## Gmail

---

### Using Gmail

---

When you first set up HTC Rezound with Beats Audio, make sure you sign into your Google Account to use Gmail. If you didn't do so, go to the **Accounts & sync** setting to sign in.

You can also set up more than one Google Account on HTC Rezound with Beats Audio, and then switch between accounts in Gmail.

## Viewing your Gmail Inbox

All your received emails are delivered to your Inbox.

From the Home screen, tap  > Gmail. Your Gmail inbox then opens.

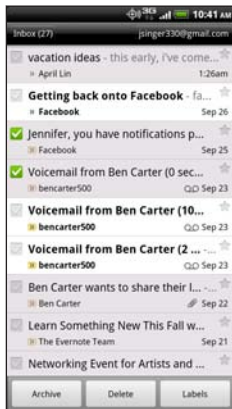

Archive, delete or label multiple conversations

Tap  before the email or conversation. Then tap the onscreen buttons at the bottom to choose what to do with the selected messages or conversations.

Display drafts, sent messages, and other labels

Tap **Inbox** at the top left of the screen, and then tap another label (such as **Sent**, **Drafts**, or your created label) to view its messages and conversations.

Switch to your other Gmail account

Tap the current account at the top right of the screen, and then tap another account you want to switch to.

Refresh the Inbox

Press MENU , and then tap **Refresh**.



## Sending a new message

1. In the Gmail inbox, press MENU  and then tap **Compose**.



2. If you've set up multiple Google Accounts on HTC Rezound with Beats Audio, choose which Gmail address you want to use for sending your email. Tap the box that shows your current Gmail address, and then tap another address that you want to use for sending.
3. Enter the message recipient's email address in the **To** field. If you are sending the email to several recipients, separate the email addresses with a comma.



If you want to send a carbon copy (Cc) or a blind carbon copy (Bcc) of the email to other recipients, press MENU  and then tap **Add Cc/Bcc**.

4. Enter the email subject, and then compose your email.
5. If you want to attach a picture, press MENU  and then tap **Attach**.
6. Locate and then tap the picture you want to attach.
7. After composing your message, tap .





While composing the message, tap  to save it as a draft. Or press **BACK**  to discard the message.

---

## Replying to or forwarding an email message

---

1. In the Gmail inbox, tap the email message or conversation.
2. To reply to the sender, tap . Or, tap  and choose whether to **Reply all** or **Forward**.

3. Do one of the following:
  - If you selected **Reply** or **Reply all**, enter your reply message.
  - If you selected **Forward**, specify the message recipients.



Tap **Respond inline** if you want to interleave your new message with the received email. But this removes any attachments or formatting in the original email.

4. Tap .

---

## Getting help

---

To find out more about using Gmail, press MENU , and then tap **More > Help**. The web browser will take you to the Google Mobile Help site.

## Mail

---

### About the Mail app

---

Use the Mail app to add your webmail and other POP3 or IMAP email accounts. You can also set up and use your Exchange ActiveSync email on HTC Rezound with Beats Audio.



You can add the Mail widget to view your POP3/IMAP or Exchange ActiveSync emails on the Home screen.

---

### Adding a POP3/IMAP email account

---

1. From the Home screen, tap  > Mail.

2. Do one of the following:
  - If this is your first time to add an email account in Mail, tap **Other (POP3/IMAP)** on the Choose a mail provider screen.
  - If you've already added an email account in Mail, press MENU , and then tap **More > New account**. If the Choose a mail provider screen is displayed, tap **Other (POP3/IMAP)**.
3. Enter the email address and password for your email account and then tap **Next**.
4. If the account type you want to set up is not in the internal database, you'll be asked to enter more details.
5. Enter the account name and your name and then tap **Finish setup**.

---

### Adding a Microsoft Exchange ActiveSync account

---

You can add one or more Microsoft Exchange ActiveSync accounts on HTC Rezound with Beats Audio. You can sync with Microsoft Exchange Server 2003 Service Pack (SP2) or later.



You can add up to 15 Exchange ActiveSync accounts on HTC Rezound with Beats Audio.

1. From the Home screen, tap  > **Mail**.
2. Do one of the following:
  - If this is your first time to add an email account in Mail, tap **Microsoft Exchange ActiveSync** on the Choose a mail provider screen.

- If you've already added an email account in Mail, press MENU , and then tap **More > New account**. If the Choose a mail provider screen is displayed, tap **Microsoft Exchange ActiveSync**.
3. Enter the Exchange ActiveSync account details, and then tap **Next**. If your corporate Exchange Server does not support auto-detect, you'll need to enter your Exchange Server settings after you tap **Next**. Ask your Exchange Server administrator for details.
  4. Choose the types of information you want to sync. Also choose how often you want to update and sync email to HTC Rezound with Beats Audio, then tap **Next**.
  5. Enter the account name, then tap **Finish setup**.

---

## Checking your Mail inbox

---

When you open the Mail app, it displays the inbox of one of your email accounts that you've set up on HTC Rezound with Beats Audio.

To switch between email accounts, tap the bar that shows the current email account, and then tap another account.

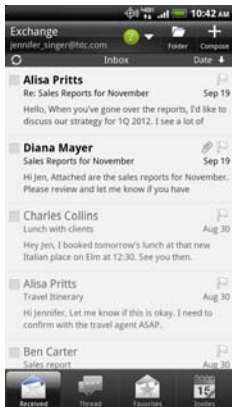

### Viewing the unified inbox of all your email accounts

You can view email messages from all your accounts just in one place without having to switch to different accounts.

Just tap the bar that shows the current email account, and then tap **All accounts**. Email messages are color coded so you can easily distinguish which email accounts they belong to.





Up to 15 email accounts can be shown in the unified inbox.

## Switching between different views of your inbox

If you have lots of email messages, it may take you some time to browse through the long list and find a single email or related email messages. Use the tabs of the Mail app to sort your emails into different categories.

To skim through your email messages easier, tap one of the following tabs to change the view of your inbox:



### Received

Displays email messages as individual items.



### Thread

Displays email messages as conversations, grouped according to the subject line. Tap a subject in the list to show the email conversation.



### Favorites

Displays all email messages from a contact group. To choose which contact group to display, press MENU , tap **View**, and then select a group.



### Unread

Displays unread messages.



### Marked (Exchange ActiveSync only)

Displays all flagged messages.



### Invites or Meeting invitations (Exchange ActiveSync only)

Displays meeting invitations which you have not yet accepted or declined.



### Attached



Displays all messages that have attachments.



Can't see the tab that you want? Press and hold a tab and wait for the screen to show the other tabs. You can tap and hold a tab, and then drag it to where you want it.

## Refreshing an email account

Whatever your automatic synchronization settings are, you can also synchronize your sent and received emails manually at any time.

- While in the account you want to synchronize, press MENU , and then tap **Refresh**.
- If you have several email accounts, you can refresh them all at the same time. Go to the All accounts inbox first. Then press MENU  and tap **Refresh**.

## Sorting email messages

You can sort email messages by date received, priority, subject, sender, or size.

On the inbox, press MENU , tap **Sort**, and select from the sorting options.

## Quickly browsing your inbox

If you have a long list of email messages in your inbox, it may not be easy to browse the list and find an email that you want. You can quickly browse through your inbox by using finger gestures.

1. Choose a sorting order for displaying your email messages.
2. Press and hold two fingers on any email message, and then drag upward or downward without lifting your fingers. Your screen then jumps to the set of email messages based on your chosen sorting order.

---

## Managing email messages

---

### Deleting an email message

1. On the inbox, press and hold the message you want to delete.
2. On the options menu, tap **Delete**.

### Selecting several email messages

1. Tap the check boxes of email messages to select them.
2. Choose what you want to do with the selected messages: **Mark read** (or mark **Mark unread**), **Delete**, or **Move to** another folder.



You cannot move two or more email messages at the same time when you're in the unified (All accounts) inbox.

## Moving several email messages to another folder

1. Switch to the email account you want to use.
2. Tap the check boxes of email messages you want to move.
3. Tap **Move to**, and then tap the folder where to move the email messages.

## Moving an email message after reading

1. While viewing the email, tap **Move to**.
2. Tap the folder where you want to move the email message.

## Deleting all messages

1. First tap the check box of any email message.
2. Press MENU , and then tap **Select all**.
3. Tap **Delete**.

## Switching to other mail folders



1. Tap .
2. Tap the mail folder which contains the messages you want to view.

---

## Sending an email message

---

1. From the Home screen, tap  > **Mail**.

2. Switch to the email account that you want to use for sending email.
3. On the email account inbox, tap .
4. Fill in one or more recipients. You can:
  - Enter email addresses directly in the **To** field, separating them with a comma. As you enter email addresses, any matching addresses from your contacts list are displayed. Tap a match to enter that address directly.
  - Tap the  icon, and then choose the contacts to whom you want to send the message. You can also select contact groups as recipients, or search and add contacts.

If the contact name you entered is not found and you have an Exchange ActiveSync account in the Mail app, you can search for the contact in your company directory.



If you want to send a carbon copy (Cc) or a blind carbon copy (Bcc) of the email to other recipients, press MENU , and then tap **Show Cc/Bcc**.

5. Enter the subject, and then compose your message.
6. To add an attachment, press MENU , tap **Attach**, and choose from the following options:

Picture	Take a photo and attach it, or attach an existing photo.
Video	Record a video and attach it, or attach an existing video.
Audio	Attach an audio file.

<b>App recommendation</b>	Choose an app you've installed from Android Market that you want to tell other people about. The URL from which the app can be downloaded will be inserted in your email.
<b>Location</b>	You can attach location information. Send your current location (requires GPS to be turned on) or a location you pick on a map.
<b>Document</b>	Attach a PDF file or an Office document such as a text file or a spreadsheet.
<b>Contact (vCard)</b>	Attach someone's contact information.
<b>Appointment (vCalendar)</b>	Attach a calendar event.
<b>File</b>	Attach any other file.

7. Tap **Send** to send the message immediately, or tap **Save as draft** to send it later.



If there's no Internet connection available or Airplane mode is on when you send your email, the email will be saved to the Outbox folder. Once there's Internet connection available, the saved email will be sent automatically next time HTC Rezound with Beats Audio syncs.

### Resuming a draft email message

1. In the email account inbox, tap  > **Drafts**.
2. Tap the message.

3. When you finish editing the message, tap **Send**.

### Managing the recipient list

Filled up the To field but want to make changes in it? You can manage the recipient list and change who appears in the To, Cc, and Bcc fields.



You must have entered contacts in the To, Cc, or Bcc field.

1. In the To, Cc, or Bcc field, tap the Edit button. The names of the contacts are listed.
2. Tap the checkbox beside the contact that you want to move to another field.
3. Tap the action that apply.
4. When you are done with the changes, press **BACK**  to go back to composing your email.

---

### Reading and replying to an email message

---

1. From the Home screen, tap  > **Mail**.
2. Switch to the email account you want to use.
3. On the email account inbox, tap the email you want to read.
4. Choose an action on the bottom of the screen for your email.



Press MENU  to see options for deleting your email or marking it as unread.

## Where are my unread emails?

The Unread tab contains all your unread emails. Add it if it does not appear on your screen.

1. Press and hold a tab. When the screen changes and shows you the area where you can rearrange icons, lift your finger.
2. Press and hold the Unread tab, and then drag it to its new position.
3. Press BACK , and then tap the Unread tab.

## Saving an email in the Tasks app

Save an email in your Tasks list so you can remind yourself when to reply.

1. Press and hold the email that you want to save, and then tap **Save as task**.
2. On the New Task screen, enter a name for the task.
3. Enter other task details, and then tap **Save**.



---

## Setting the priority for an email message

---

You can set the priority for an email message that you send.

1. While composing the message, press MENU .
2. Tap **Set priority**.
3. Select the priority for the message.



If you selected **High** or **Low** priority, the priority appears below the subject line of the message.

---

## Searching and filtering emails

---

Search emails in all your email accounts or in a specific one. You can even refine your search by indicating which part of the email will be searched.

1. Press SEARCH .
2. If you want to refine or filter your search, tap  and then check the options that apply. For example, you can focus the search on a part of an email or filter emails that have attachments or tagged as high priority.
3. Tap **OK**.
4. Enter the first few characters of the item you're looking for in the search box. Results will then be listed.

Tap a result to open the email.

## Searching emails from a contact

Do you remember the sender, but can't find a particular email from this contact? You can search your mail accounts for emails from a specific contact.

1. Switch to the email account you want to use.
2. Press and hold an email from a contact.
3. Tap **Search the mail from the sender**. A list of emails from that contact appears.



---

## Working with Exchange ActiveSync email

---

You can read, reply, send, and manage your work email in the same easy way as with a POP3/IMAP account. In addition, you can also use some powerful Exchange features.

### Flagging an email

- While viewing the inbox, tap the white flag icon  that appears on the right of an email message. The icon turns red  after you flagged the email.
- While reading an email, you can also tap the flag icon in the email.

### Setting your Out of the office status

1. Switch to your Exchange ActiveSync account.
2. Press MENU  and then tap **More > Out of the office**.

3. Tap the box, and then select **Out of the office**.
4. Set the dates and times for the period when you will be out of the office.
5. Enter the auto-reply message.



You can also send auto-reply messages to external recipients, which are contacts whose addresses are not in the same Microsoft Exchange server.

6. Tap **Save**.

### Sending a meeting request

1. Switch to your Exchange ActiveSync account.
2. Go to the Invitations tab, and then tap **+**.
3. Enter the meeting details.
4. Tap **Save**.

---

### Changing email account settings

---

1. Switch to the email account whose settings you want to change.
2. Press MENU **☰**, and then tap **More > Settings**.

## 3. Select from the following:

<b>Account settings</b>	Change the email account settings such as the name, email address, password, and description.
<b>General settings</b>	Set the font size when reading emails, enable, disable or set the signature, set the account as the default email account, and set where to save email attachments.
<b>Send &amp; Receive</b>	Set the sync settings for incoming and outgoing emails such as maximum size limit, update schedule, and more.
<b>Notification settings</b>	Set email notification settings.
<b>Delete account</b>	Tap to delete the email account.

4. Press BACK  to save your changes.

## Deleting an email account

1. Switch to the email account you want to delete.
2. Press MENU , and then tap More > Settings > Delete account.

# Calendar

## About Calendar

Never miss an important date again. Use the Calendar app to schedule your events, meetings, and appointments.

You can set up HTC Rezound with Beats Audio to stay in sync with the following types of calendars:

- On HTC Rezound with Beats Audio, sign in to your Google Account so you can sync the Calendar app with your Google Calendar online. You can add multiple Google Accounts.
- If you're using Microsoft Outlook on your computer, you can set up HTC Sync on your computer to sync Outlook Calendar with the Calendar app.
- If you have a Microsoft Exchange ActiveSync account and you've added it on HTC Rezound with Beats Audio, you can sync the Calendar app with your Exchange ActiveSync calendar events.



If you've signed in to Facebook, birthdays and events of friends will appear in Calendar.

## Creating an event

You can create events that sync with your Google or Exchange ActiveSync calendars, as well as events on HTC Rezound with Beats Audio.



Not signed in yet on your accounts? Your calendar events will be created under PC Sync, which you can later sync with your computer's Outlook Calendar through HTC Sync.

1. From the Home screen, tap  > **Calendar**.
2. On any Calendar view, tap .
3. If you have more than one calendar, select a calendar in which to add the event.
4. If you want to invite people to your event, tap  and choose attendees from your contacts or company directory. For Google and Exchange ActiveSync calendar events, you can also enter email addresses in the Guest field.
5. Enter a name for the event.
6. To specify the date and time of the event, do one of the following:
  - If there is a time frame for the event, tap the **From** and **To** date and time to set them.
  - If it is a whole-day event, such as a birthday, set the **From** and **To** date, then select the **All day** check box.
7. Enter the event location and description.
8. Set the reminder time.







You can add another reminder time in a Google Calendar event. Press MENU  and then tap **Add reminder**.

9. If the event occurs on a regular basis, tap the **Repetition** box and then choose how often the event occurs.
10. Tap **Save**.

## Changing Calendar views

Easily switch between different calendar views by tapping the onscreen buttons.

	Day view
	Week view
	Month view
	Agenda view
	Meeting invitations



- In Day, Week, and Agenda views, events are color coded to indicate which account or type of calendar they belong to. To find out what each color represents, tap .
- Can't see the tab that you want? Press and hold a tab and wait for the screen to show the other tabs. You can press and hold a tab, and then drag it to where you want it.

---

## Using month view

---

In month view, you will see markers on days that have events.

Do any of the following in month view:

- Tap a day to view the events for that day.
- Press and hold a day to open an options menu from which you can also choose to create an event or switch to either day or agenda view.
- Slide your finger up or down the screen to view earlier or later months.

---

## Using day and agenda views

---

Day view shows your events per day, whereas agenda view displays all your events in chronological order.

When in day view:

- Press and hold on a time slot to create a new event at that time.
- Slide left or right across the screen to view earlier or later days.
- You can also see the day's weather, but only if it's within the five-day forecast.



---

## Using week view

---

Week view displays a chart of the events of one week.

When in week view, you can:

- Press and hold on a time slot to create a new event at that time.
- Tap an event (shown as colored blocks) to view its details.
- Slide left or right across the screen to view earlier or later weeks.

---

## Managing Calendar events

---

---

### Viewing an event

---

You can view your own events as well as events that other people have shared with you.

1. In day view or agenda view, tap an event. The Event details screen then opens and shows the summary of the event.
2. Depending on the event information, do any of the following:
  - Find the event's location in Maps.
  - Call any phone number included in the event location or description.
  - Check the participants of the event.
  - If the event was sent as a meeting invitation, respond to the invitation.
  - If it's an Exchange ActiveSync calendar event, reply by email to the organizer or to all the guests. Press MENU , and then tap **Reply** or **Reply all** (or **More > Reply** or **Reply all**).

- Select any text and look it up on the Web.
  - Tap the reminder time to change it.
3. Press BACK  to return to the Calendar view.



In any Calendar view, you can return to the current date by pressing MENU  and then tapping **Today**.

---

## Editing an event

---

You can edit events that you have created.

1. While viewing an event, tap .
2. Make your changes to the event.
3. When you're done editing, tap **Save**.

---

## Deleting an event

---

Do any of the following:

- While viewing the summary of an event on the Event details screen, press MENU  and then tap **Delete event**.
- In day, agenda or week view, press and hold an event and then tap **Delete event**.
- When editing an event, tap **Delete**.

If the event repeats, you'll be asked whether you want to delete just that occurrence or all occurrences from Calendar.

---

## Sharing an event (vCalendar)

---

You can share a calendar event as a vCalendar using Bluetooth or by sending it as a file attachment with your email or message.

1. While viewing an event, press MENU , and then tap **Forward**.
2. Do one of the following:
  - Tap **Bluetooth**. You'll be asked to turn on Bluetooth on HTC Rezound with Beats Audio and connect to the receiving Bluetooth device.
  - Tap **Mail**. A new message window opens and automatically includes the vCalendar as an attachment. Your default email account will be used to send the message.
  - Tap **Message**. A new message window opens and automatically includes the vCalendar as a multimedia attachment.

## Accepting or declining a meeting invitation

1. If you're using an Exchange ActiveSync account on HTC Rezound with Beats Audio, tap the **Invites** tab in Calendar to see meeting invitations which you have not yet accepted or declined.
2. Tap a meeting invitation, and then do one of the following:
  - Accept, decline, or tentatively accept the invitation or propose a new time.
  - Press MENU  to see options for replying, moving the invitation to a folder, and more.

## Dismissing or snoozing event reminders

If you have set at least one reminder for an event, the upcoming event icon  will appear in the notifications area of the status bar to remind you of the upcoming event.

1. Tap the status bar, then slide your finger down the screen to open the Notifications panel.
2. Do one of the following:
  - Tap **Clear** to dismiss event reminders and all other notifications.
  - After sliding open the Notifications panel, tap the calendar event reminder. You'll then see a list of all pending event reminders. Tap **Snooze all** to snooze all event reminders for five minutes, or tap **Dismiss all** to dismiss all event reminders.
  - Press **BACK**  to keep the reminders pending in the notifications area of the status bar.

## Showing or hiding calendars

In any Calendar view, tap , and then select or clear a calendar to show or hide it.



Calendars are kept synchronized on HTC Rezound with Beats Audio, whether or not you hide them.

## Changing Calendar settings

You can change Calendar settings to specify how it displays events and how it notifies you of upcoming events.

In any Calendar view, press MENU  and then tap **Settings** (or **More > Settings**).

---

### Reminder settings

---

All calendars	Select this check box to use the same event reminder settings for all types of calendars. If you clear this check box, you can set different reminder settings for each calendar.
Set alerts & notifications	Configure event reminders to open an alert, send you a notification, or turn off event notifications on HTC Rezound with Beats Audio.
Default reminder time	Choose how soon before an event you want to be notified.
Select ringtone	Choose a ringtone to sound when you receive an event reminder.
Hide declined events	Choose whether to show or hide events for which you've declined invitations.

---

### Calendar view settings

---

First day of week	Set the month and week views to start on a Sunday or Monday.
-------------------	--

<b>Include weather</b>	Select this check box to show weather information in the day view events list.
<b>City</b>	If weather is included, by default, day view displays your current location's weather. You can change it to display the weather of another city.

## About the Calendar widget

You can add a Calendar widget to your Home screen. The widgets offer different calendar views.

Tapping a day or event on the widget brings you to the Calendar app.

# Maps and location

## Location settings

---

### Turning on location services

---

In order to find your location on HTC Rezound with Beats Audio, you need to enable location sources.

1. From the Home screen, press MENU  and then tap **Settings > Location**.
2. Select the location services you want to use:

<b>VZW Location Services</b>	Uses Wi-Fi or your mobile data connection to find your approximate location.
<b>Standalone GPS Services</b>	Finds your exact GPS location. This requires a clear view of the sky and more battery power.
<b>Google Location Services</b>	Uses Google location services to track your location. When selected, you'll also allow Google to collect anonymous location data from your wireless device.

## Footprints

---



### Recording favorite places with HTC Footprints

---

HTC Footprints™ provides an easy way to record your favorite places and revisit those places. You can take a photo of a location such as a restaurant or sightseeing spot and store it together with its precise GPS location, street address, phone number, and more.

The next time you want to visit the same place, just open the footprint. You can then view the location on the map, search for it on the Web, and more.

#### Adding a location as a footprint

1. From the Home screen, tap  > **Footprints**.
2. Tap **Save to Footprints**.
3. You can:
  - Tap **Reshoot** to take a picture and add it as a photo for the footprint.
  - Tap  to fine tune the position of the footprint on the map.
  - Tap  to change the category.
  - Tap **Edit** to change the name, category, or address of the footprint, enter the phone or website, add a voice memo, and more.
4. Tap **Done**.

#### Revisiting a footprint

1. In Footprints, tap a category.



2. Tap the footprint you want to revisit.
3. Tap the information fields to get directions, share the footprint, call a stored phone number, and more.

### Editing or deleting a footprint

1. In Footprints, tap a category.
2. Press and hold the footprint you want to edit or delete.
3. Tap **Edit** or **Delete** on the options menu.

### Sharing your footprints

1. In Footprints, tap a category.
2. Press and hold the footprint that you want to share.
3. Tap **Share**, and then choose from the sharing options.

### Deleting multiple footprints

1. In Footprints, tap a category.
2. Press **MENU** , and then tap **Delete**.
3. Select the footprints you want to delete, and then tap **Delete**.

### Exporting your footprints

Back up footprints by exporting them. You can also open exported footprints files in other applications such as Google Earth™ on your PC.

1. In Footprints, tap a category.
2. Press **MENU** , and then tap **Export**.



Press **MENU**  and then tap **Deselect all** to deselect all the footprints.

Footprints are exported as .kmz files. If you exported multiple footprints at one time, they are saved together in one .kmz file.

### Importing footprints

Bring back footprints you previously backed up. You can also import .kmz files that you saved in other applications.

1. In Footprints , press **MENU** , and then tap **Import**.
2. Tap **Footprints data**, and then tap the file you want to import.

## Google Maps

---

### About Google Maps

---

Google Maps™ lets you track your current location, view real-time traffic situations, and receive detailed directions to your destination.

It also provides a search tool where you can locate places of interest or an address on a map, or view locations at street level.



- You need to connect to the Internet to use Google Maps.
- To find your location with Google Maps, you need to enable location sources.
- The Google Maps app does not cover every country or city.



---



## Getting around maps

---

When you open Google Maps, you can easily find your location on the map or check out nearby places by panning and zooming in and out on the map.

**F** To find your location with Google Maps, you need to enable location sources.

1. From the Home screen, tap  > **Maps**.
2. Tap  to show your current location. The blue marker  shows your current location on the map.
3. Do any of the following:

<b>Move around</b>	Swipe your finger to any direction on the screen to view nearby places on the map.
<b>Use Compass mode</b>	Tap  to switch to Compass mode. In Compass mode, the map changes to an angled view and automatically orients itself depending on the direction you're facing.
<b>Zoom in</b>	<ul style="list-style-type: none"><li>▪ Place your thumb and index fingers on top of the area that you want to zoom in, and then spread your fingers across the map.</li><li>▪ Tap .</li><li>▪ Double-tap the area on the map that you want to zoom in.</li></ul>



<b>Zoom out</b>	<ul style="list-style-type: none"><li>▪ Pinch your thumb and index finger on the map to zoom out.</li><li>▪ Tap .</li></ul>
<b>View information for a random location</b>	<ol style="list-style-type: none"><li>1. Press and hold a location on the map. A balloon opens over the location, with the address and a thumbnail from street view (if available).</li><li>2. Tap the balloon to see more information. You can get directions to the location, check for nearby places of interest, and more.</li></ol>

---

## Searching for a location

---

In Google Maps, you can search for a location, such as an address or a type of business or establishment (for example, museums).

1. In Maps, enter the place you want to search for in the search box.
2. Tap  to search for the location you entered or tap a suggested search item. The search results are displayed as markers on the map.
3. Do any of the following:
  - Tap a marker  to see if that is what you're looking for, tap the balloon if it is.
  - Tap  to show the search results as a list, and then tap the location.

Details about the selected location displays on the screen.

4. Do any of the following:
  - Tap the onscreen buttons to view the location on a map, get directions, view the location in Street View, if available, and more. Scroll down the screen to view more options.
  - Swipe left or right across the screen to view the information for the next or previous search result.

### Clearing the map

After searching on a map, you can clear away the various markers drawn on it.

Press MENU , and then tap **Clear Map**.

---

### Searching for a place of interest near you

---

Use Places to find places of interest near your current location. Places uses Google Maps to search common places that you would want to find, such as the nearest gas station or ATM kiosk.



Before using Places, you need to enable location sources.

1. From the Home screen, tap  > **Places**.
2. Tap the type of place you want to search.

### 3. Do any of the following:



- When one or two places of interest are found, the search results are displayed as markers on the map. You can tap the marker, and then tap the balloon to view more information about the place.
- When several places are found, the search results display in a list. Tap a place to view more information.

---

## Getting directions

---

Get detailed directions to your destination. Google Maps can provide directions for travel by foot, public transportation, or car.

1. While viewing a map, press MENU , and then tap **Directions**.
2. Do any of the following:
  - Use your current location as the starting point, or enter a location from where to start in the first text box. Then enter your destination in the second text box.
  - Tap  to select an address from your contacts or a point that you tap on a map.

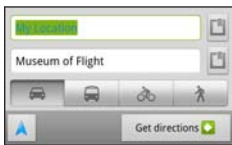

3. Choose how you want to get to your destination by tapping the car, public transit, bike, or walk button.

4. Tap **Get directions**. The next screen displays the directions to your destination in a list.



If the place you've set as your destination has several locations available, choose which one to go to.

5. Tap an item to view the directions on the map.
6. Tap the arrow buttons on the map to follow the directions.

When you're finished viewing or following the directions, press MENU  and then tap **Clear Map** to reset the map. Your destination is automatically saved in the Google Maps history.

---

## Getting help

---

Get help and more information about Maps.

To open the help, press MENU , and then tap **More > Help**. The web browser opens and takes you to the Google Maps Help site.

---





## Finding your friends with Google Latitude (available by country)

---

Google Latitude® user location service lets you and your friends share locations and status messages with each other. It also lets you get directions to your friends' locations, send your location details by email, and more.

Your location is not shared automatically. You must join Latitude, and then invite your friends to view your location or accept their invitations. Only friends that you have explicitly invited or accepted can see your location.

### Opening and joining Latitude

1. From the Home screen, tap  > **Maps**.
2. While viewing a map, press MENU  and then tap **Join Latitude**.
3. After you've joined Latitude and closed the application, you can do any of the following to open it from the Home screen:
  - Tap  > **Latitude**.
  - Open Maps, press MENU , and then tap **Latitude**.

## VZ Navigator

---

### Using VZ Navigator

---

VZ Navigator tells you where you are and what's nearby using Bing® search. Transform your phone into a powerful navigation device so you can discover destinations around town or around the globe.

1. From the Home screen, tap  > **VZ Navigator**.



2. Select an option and then follow the onscreen instructions to proceed:
  - VZ Navigator. Provides maps, turn-by-turn 3D navigation, speech input and more. This is a subscribed service.



- VZ Navigator Maps. Access free maps with traffic and satellite views.



For more information about VZ Navigator, visit: <http://www.verizonwireless.com/vznavigator>

# Android Market and other apps

## Finding and installing apps from Android Market

Android Market is the place to go to find new apps for HTC Rezound with Beats Audio. Choose from a wide variety of free and paid apps ranging from productivity apps, entertainment, to games.



A Google Checkout™ payment method is required to purchase a paid app. You will be asked to confirm method of payment when you purchase an app.

---

## Finding and installing an app

---

When you install apps and use them on HTC Rezound with Beats Audio, they may require access to your personal information or access to certain functions or settings. Download and install only apps that you trust.





Be cautious when downloading apps that have access to functions or a significant amount of your data on HTC Rezound with Beats Audio. You're responsible for the results of using downloaded apps.

You need a Google Checkout™ account to purchase items on Android Market.

1. From the Home screen, tap  > **Market**.

- Do any of the following to find an app:

<b>Browse featured apps</b>	Tap a featured app on Android Market main screen.
<b>Browse apps and games by categories</b>	Tap <b>Apps</b> or <b>Games</b> , and then scroll left or right on the screen to filter apps and games by <b>CATEGORIES</b> , <b>FEATURED</b> , <b>TOP FREE</b> , and more.
<b>Search for an app</b>	Press <b>SEARCH</b>  , enter the name or type of app you're looking for, and then tap  .

- When you find the app that you like, tap it and read its description and user reviews.
- To download or purchase the app, tap **Download** (for free apps) or the price button (for paid apps).
- Tap **Accept & download** or **Accept & buy** to accept the permissions for the app and begin downloading and installing the app.



You can uninstall an app for a refund within a limited time after your purchase. To know more about the refund policy for paid apps, please visit the Android Market Help site (<http://market.android.com/support>).



---

## Opening an installed app

---

Do one of the following:

- If you see this icon  on the status bar, open the Notifications panel, and then tap the app.



- From the Home screen, tap  > **Market**. Press MENU  and then tap **My apps**. On the My apps screen, tap the app, and then tap **Open**.
- From the Home screen, tap . On the All apps screen, slide to the Downloaded tab, and then tap the app.

---

## Uninstalling an app

---

You can uninstall any app that you have downloaded and installed from Android Market.

1. From the Home screen, tap  > **Market**.
2. Press MENU  and then tap **My apps**.
3. Tap the app you want to uninstall, and then tap **Uninstall**.
4. When asked, tap **OK**.

---

## Getting help

---

If you need help or have questions about Android Market, press MENU , and then tap **Help**. The web browser will take you to the Android Market Help site.

## Using the Clock

---

### About the HTC Clock widget

---

Use the HTC Clock widget to see your current date, time, and location. You can also use the Clock to show the time in another city.



### Changing the location on the Clock widget

By default, the Clock widget displays your current weather. You can customize the Clock widget on your Home screen to show the weather of another location.

1. Press and hold the Clock widget and then drag it to the **Edit** button.
2. Choose a city.  
If you don't see the city that you want, tap **+** to search for it and add it.
3. Tap **Done**.



You can add more than one Clock widget to the extended Home screen. Choose from a variety of looks and designs and select the city to display.

---

## Using the Clock app

---

Get more from the Clock app than just the regular date and time. Use HTC Rezound with Beats Audio as a desk clock complete with weather information or as a world clock so you can see what time it is in several cities across the globe. You can also use it as an alarm clock, stopwatch, and countdown timer.



To open the Clock app, tap the Clock widget on the Home screen. Tap the tabs on the bottom row or slide your finger across the tabs to switch between the different functions of the Clock app.

---

## Using Desk Clock

---

The Desk Clock displays the current date, time, and weather. It also shows an alarm clock indicator and the battery level.

- Tap the weather image or information to open the Weather app where you can see weather forecasts for the next few days.
- Tap  to switch to Dock Mode. Tap  to exit Dock Mode.

---

## Using World Clock

---

Use the Clock app's World Clock tab to check the current time in several places around the globe. You can also set your home city, add more cities to the world clock list, and manually set your time zone, date, and time.

## Setting your home city

1. On the World Clock tab, press MENU  and then tap **Home settings**.
2. Enter your home city's name. As you enter letters, the list is filtered to show matching cities and countries.
3. Scroll through the list and tap your home city.

## Setting the time zone, date, and time

To set the time zone, date, and time on HTC Rezound with Beats Audio manually, you need to turn off auto time sync first.

1. On the World Clock tab, press MENU  and then tap **Local time settings**.
2. Clear the **Automatic** check box, and then set the time zone, date, and time as required.



From the Home screen, you can also press MENU  and then tap **Settings > Date & time** to open the Date & time settings screen.

## Adding a city to the World Clock screen

Add more cities to the World Clock screen so you can instantly check the date and time in these cities.

1. On the World Clock tab, tap .
2. Enter the city name you want to add. As you enter letters, the list is filtered to show matching cities and countries.



3. Scroll through the matching list and tap the city that you want to add.

---

## Setting an alarm

---

You can use the Clock app's Alarms tab to set up one or more wake-up alarms.

1. On the Alarms tab, select the check box of an alarm and then tap that alarm.
2. Under Set alarm, drag your finger up or down to roll the time scroll wheels and set the alarm time.
3. Choose from the available options. You can:
  - Enter the alarm **Description** and choose the **Alarm sound** to use.
  - Tap **Repeat**. Select which days of the week to sound the alarm, and then tap **OK**.
  - Select the **Vibrate** check box if you want HTC ReSound with Beats Audio to also vibrate when the alarm goes off.
4. After you've finished setting the alarm, tap **Done**.



- To turn off an alarm, clear the check box of that alarm.
- If you need to set more than three alarms, tap **+**.

## Deleting an alarm

1. On the Alarms tab, press MENU and then tap **Delete**.

2. Select the alarms you want to delete and then tap **Delete**.

### Changing alarm sound settings

On the Alarms tab, press MENU  and then tap **Settings**. You can change the following settings:

<b>Alarm in silent mode</b>	Selected by default, this option allows the alarm to sound even when the volume is set to silent. Clear this check box if you want to silence the alarm when HTC Rezound with Beats Audio is in silent mode.
<b>Alarm volume</b>	Set the volume level that you want for the alarm.
<b>Snooze duration</b>	Set how long to snooze between alarms.
<b>Side button behavior</b>	Choose what happens to the alarm when pressing the side button (VOLUME UP/VOLUME DOWN). You can set the button to snooze, dismiss the alarm, or disable the button. The side button works only when the screen is not locked.



## Checking Weather

Use the Weather app and widget to check the current weather and weather forecasts for the next few days. In addition to your current location, you can view weather forecasts for other cities around the globe. Your settings in the Weather app also control the weather information that is shown in the Clock and Calendar.



For HTC Rezound with Beats Audio to detect your current location and display your local weather in the Weather app and widget as well as in Clock and Calendar:

- You need to connect to the Internet.
- Location services must be enabled. If you didn't enable it when you first set up HTC Rezound with Beats Audio, you can do so in **Settings > Location**.



1. From the Home screen, tap  > **Weather**.
2. Swipe your finger up or down the screen to check the weather in other cities.
3. Tap  to see the current weather information such as the temperature, approximate time of sunset, and more.
4. While viewing forecasts, you can:
  - Swipe your finger up or down the screen to check the weather in other cities.
  - Tap  to update the weather information at any time.

---

## Adding a city to the Weather screen

---



Add more cities to the Weather screen so you can instantly check the weather forecasts in these cities. In addition to your current location, the Weather screen can display up to fifteen cities.

1. On the Weather screen, tap . Or press MENU  and then tap **Add**.
2. Enter the location you want to add. As you type, the list is filtered to show the possible locations based on the letters you entered.
3. Tap the desired city to select it.

---

## Changing the order of cities on the Weather screen

---

1. On the Weather screen, press MENU  and then tap **Edit**.
2. Press and hold  at the end of the item you want to move. When the row is highlighted, drag it to its new position, then release.
3. Tap **Done**.

---

## Deleting cities from the Weather screen

---

1. On the Weather screen, press MENU  and then tap **Edit**.
2. Select the check boxes of the cities you want to remove, and then tap **Done**.

---

## Changing Weather options

---

1. On the Weather screen, press MENU  and then tap **Settings**.

2. You can change the following weather settings:

<b>Update when opened</b>	Select this check box to refresh weather updates every time you open the Weather app.
<b>Scheduled sync</b>	Select this check box to automatically download weather updates.
<b>Update schedule</b>	Set an auto update schedule.
<b>Temperature scale</b>	Choose whether to display the temperature in Celsius or Fahrenheit.
<b>Sound effects</b>	Choose whether to play sound effects related to the weather conditions.
<b>Monitor my location</b>	Select this check box to frequently update your current location.

---

### About the Weather widget

---

Use the Weather widget to instantly check weather forecasts of your current location and other cities without having to open the Weather app. The Weather widget comes in different looks and styles.

You can add this widget to the Home screen, if it's not yet added.

## Reading news feeds

Don't get left behind with yesterday's stories. Use the News app to subscribe to news feeds that cover breaking news, sports, top blogs, and more. You can also get updates based on specific keywords.



---

### Subscribing to news channels

---



You need to be signed in to a Google Account before using the News app.

1. From the Home screen, tap  > **News**.
2. Tap , and then tap **Subscriptions > Add feeds**.
3. Do one of the following:
  - Tap a category such as **Blogs** or **Entertainment** to choose from popular news feeds.
  - Tap **Search more** to search for a specific keyword or feed URL.
4. After selecting the channel or channels to subscribe to, tap **Add**.





To manually update news stories on your channels, press **MENU** , and then tap **Refresh**.

---

## Adding a keyword

---

Easily find stories that interest you by entering a search keyword.



1. From the Home screen, tap  > **News**.
2. Tap , and then tap **My items > Keywords > Add keywords**.
3. Enter the keyword, and then tap **Add**. Your new keyword is displayed under the Keywords list.
4. Tap the keyword to show the stories that contain that keyword.

---

## Adding people to follow

---

Get updated with stories and comments shared by your Google contacts.

1. From the Home screen, tap  > **News**.
2. Tap , and then tap **People you follow > Add new friends**.
3. Enter the name of a Google contact, and then tap .
4. Select your contact from the search results, and then tap **Add**. Your contact is listed under People you follow.

To see stories and comments recently shared by a contact you're following, tap the contact's name under People you follow.



---

## Reading a story

---

1. From the Home screen, tap  > **News**.
2. On the All items screen, tap a story that you want to read.

- While reading the story, you can:

Tap	To
	Star the story as a favorite.
Like	Like the story.
Read full article	Go to the web page where the story is published.
Share	Share a link to the story from the available options.
	Go to the next or previous story in the channel.

- Press MENU  to see other options such as adding a comment or tagging the story.

---

### Changing update schedule and content settings

---

- While on the News app, press MENU , and then tap **Settings** (or **More > Settings**).
- Tap any of the following:

Accounts	Manage sync options and general News settings.
Update when opened	Update the content of the channels you've subscribed to every time you open the News app.



<b>News content</b>	Choose how to read news stories by default: whether as a summary or as a full web page article.
<b>Mobile view</b>	If you've selected to view the news content as a web page article, choose to display web page articles optimized for mobile viewing.

---

## About the News widget

---

Use the News widget to read snippets of stories that you've subscribed to right from your Home screen.

## Watching videos on YouTube

Use the YouTube app to check out what's popular on the online video-sharing website.



1. From the Home screen, tap  > **YouTube**.
2. Scroll through the list of videos, and then tap a video to watch it.
3. While watching a video, you can:
  - Turn HTC Rezound with Beats Audio sideways or double-tap the screen to watch the video in full screen.
  - Tap the video screen to pause, resume playback, or drag the slider to jump to a different part of the video.
  - Tap a tab to learn more about the video, see related videos, or check out what other viewers think. You can also slide your finger across the tabs to see if there are more items available.

- Tap the thumbs-up or thumbs-down icon to add your video rating. Tap **More** to see other options.
4. Press MENU , and then tap **Home** to return to the YouTube main screen.

---

## Searching for videos

---

1. On the YouTube main screen, tap .
2. Enter a search keyword, and then tap .
3. Scroll through the results and tap a video to watch it.



You also have the option to show results that were just recently posted. Tap **All time**, and then select a time period you want.

---

## Clearing the search history

---

1. On the YouTube main screen, press MENU , and then tap **Settings**.
2. Tap **Clear search history**, and then tap **OK** when prompted.

---

## Sharing a video link





---

1. On the video's watch screen, tap **More > Share**.
2. Choose how you want to share the video link from the available options.

---

## Capturing and sharing videos on YouTube

---



1. From the Home screen, tap  > **YouTube**.  
Or if YouTube is already open, return to its main screen.
2. Tap .
3. Tap  to start capturing video.
4. When you're finished capturing, tap  again, and then tap **Done**.
5. Enter a title for your video.
6. Tap **More details** to select the YouTube account you want to use, add a description, set the privacy level, and add tags or location information to your video.
7. Tap **Upload**.

## Sharing games and apps

Having fun with a game or app that you found from Android Market? Share your favorite games and apps instantly with your circle of friends.



For your friends to link to the app and download it from Android Market, they must be using an Android device.

1. From the Home screen, tap .
2. Press MENU , and then tap **Share**. You'll then see the list of games and apps that you downloaded and installed from Android Market.
3. Tap an app, and then choose how to share it.

When your friends see the link in your sent message, email, or status update, they can simply tap the link to go directly to the game or app in Android Market to download it.

# Productivity

## Completing tasks

Use the Tasks app to organize and track to do's and tasks.

With the Tasks app, you can:

- View a unified lists of tasks from your phone and your Exchange ActiveSync accounts.
- Create tasks and group them into lists.
- Enter details about your tasks.
- Receive a notification when a task is due.
- Postpone or edit the due date of tasks.

To open the Tasks app, tap  > Tasks.

## Not signed in to your Exchange ActiveSync account?

1. Press MENU , and then tap **Settings > Accounts & sync > Add account > Exchange ActiveSync**.
2. Enter the Exchange ActiveSync account details, and then tap **Next**. If your corporate Exchange Server does not support auto-detect, you'll need to enter your Exchange Server settings after you tap **Next**. Ask your Exchange Server administrator for details.
3. Choose the type of information that you want to sync. Make sure that you check **Tasks**.
4. Choose how often you want to sync, and then tap **Next**.
5. Enter the account name, then tap **Finish setup**.

---

## Viewing the unified task list

---

You can view and update a unified list of tasks. Tasks are color coded so you can easily distinguish which accounts they belong to.

In the Tasks app, press MENU , and then tap **Accounts** > **All accounts**.



You can also select a specific account. If you want to view only tasks that you entered using HTC Rezound with Beats Audio , tap **My tasks**.

## Filtering tasks

You can filter tasks by date due or by priority.



1. Go to the list that contains the tasks that you want to filter.
2. Press MENU , and then tap **Filter**.
3. From the list, choose how you want to filter the tasks, and then tap **OK**.

---

## Creating a list

---

You can create a list and organize your tasks under it.

1. In the Tasks app, press MENU  and then tap **Lists**.
2. Tap , and then choose an account for the list.
3. Enter a name for the list, and then tap **OK**.

---

## Managing lists

---

1. In the Tasks app, press MENU  and then tap **Lists**.
2. From here, you can:

### Show or hide a list

Tap **All lists** to show all the lists in all your accounts, or tap a specific account and then tap the list that you want to show.

### Rename a list

1. Tap an account, and then tap and hold the list that you want to rename.
2. Tap **Rename**, and then enter a new name for it.
3. Tap **OK**.

### Delete a list

1. Tap an account, and then tap and hold the list that you want to delete.
2. Tap **Delete > OK**.

---

## Creating a task

---

1. In the Tasks app, enter the task name in the New task text box.



If you want to create a task and enter the details later, tap  after you've entered the task name.

2. Tap  and then enter the task details.
3. Tap **Save**. The new task appears on the Tasks screen.



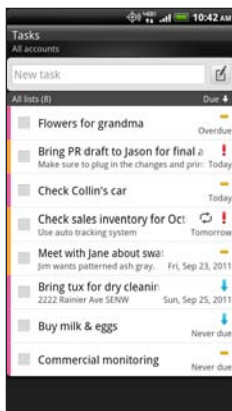

Priority. Marks your tasks as high, normal, or low priority.



Occurrence. Appears only when you set the task as recurring.

## Managing tasks

1. In the Tasks app, press MENU  and then tap **Lists**.
2. Tap the account and then tap the list where the tasks you want to manage are listed.



## 3. In the list of tasks, you can:

<b>Mark a task complete</b>	Tap the check box next to the task. The task is struck off and then disappears from the list. To view your completed tasks, press MENU  and then tap <b>Completed</b> .
<b>Sort tasks</b>	<ol style="list-style-type: none"><li>1. Press MENU , and then tap <b>More &gt; Sort</b>.</li><li>2. Select how you want to sort the tasks.</li></ol>
<b>Edit a task</b>	<ol style="list-style-type: none"><li>1. Press and hold the task that you want to edit, and then tap <b>Edit</b>.</li><li>2. Edit the task details, and then tap <b>Save</b>.</li></ol>
<b>Delete a task</b>	<ol style="list-style-type: none"><li>1. Press and hold the task that you want to delete, and then tap <b>Delete</b>.</li><li>2. Tap <b>OK</b>.</li></ol>
<b>Postpone a task</b>	Press and hold an overdue task, and then tap <b>Postpone</b> . When you postpone a task, its due date is automatically set to the day after.
<b>Move a task to another list</b>	<ol style="list-style-type: none"><li>1. Press and hold the task that you want to move, and then tap <b>Move</b>.</li><li>2. Tap the task list where you want the task to appear.</li></ol>

---

## Changing Tasks settings

---

1. In the Tasks app, press MENU  and then tap **Settings** (or **More > Settings**).
2. Change the settings and press BACK .

## Scanning codes

Use the Scan app to scan 1D bar codes, Data matrix codes, and QR codes.

The Scan app lets you:

- Scan bar codes and compare prices among online retailers and find out which stores nearby sell the same product.
- Scan codes that contain contact information, a URL to a website, an SMS message, and more. You can use the apps installed on HTC Rezound with Beats Audio to view, save, or send the scanned information.
- View previously scanned codes and edit their information

To open the Scan app, from the Home screen tap  > **Scan**.

---

## Setting up the Scan app

---

When you open the Scan app for the first time, you must set up your profile and agree to its terms of use.

1. From the Home screen, tap  > **Scan**.
2. Follow the onscreen instructions to complete the set up.

When the view finder appears, you can now start scanning codes.

---

## Scanning a code

---

Scan a code printed on most surfaces or even those displayed on computers and other devices.

1. Point HTC Rezound with Beats Audio at the code.
2. Wait for HTC Rezound with Beats Audio to focus on the code and scan it.
3. Depending on the information scanned, you can view prices of the same product on online stores, save the information, or more. The following are some of the items that can be scanned:

<b>Product information</b>	Compare prices among online retailers and find out which stores nearby sell the same product. To better locate these stores, Wi-Fi or data connection and GPS must be turned on.
<b>Web site</b>	View the URL on the browser.
<b>vCard</b>	The contact information appears as a new entry in the People app. Tap <b>Save</b> if you want to keep the information.
<b>Phone number</b>	The number appears in the Phone app. Tap <b>Call</b> to dial the phone number.

<b>SMS message</b>	The information appears as a new message in the Messages app and the phone number of the receiver is specified . Tap the text box to edit the message, and then tap <b>Send</b> .
<b>Text or other notes</b>	Press and hold the text until a menu appears. You can select and copy the text to another app.

## No information after scanning a code?



Prices and other information are available for products that are recorded in the database. If the product code scanned is not in the database, you can provide information about it.

1. After scanning the bar code, a message appears.
2. Tap the text box, and then enter information about the product.
3. Tap **Send**.

### View previously scanned codes

1. From the Scan app, press MENU  and then tap **History**. A list of scanned codes appears.

## 2. From here you can:

<b>Filter the codes</b>	Tap the icons on the top of the page to show only messages, URLs, text, phone numbers, vCards, or favorites.
<b>View the information</b>	Tap an entry to view the information contained in the scanned code.
<b>Mark a code as a favorite</b>	Tap  to mark it as a favorite.
<b>Edit the information</b>	Tap  to edit the information that appears on the History screen.

---

## Changing Scan settings

---

From the Scan app, press MENU  and tap **More > Settings**.

<b>Sound</b>	Tap <b>ON</b> to play a sound after HTC Rezound with Beats Audio scans a code.
<b>Vibrate</b>	When <b>ON</b> , HTC Rezound with Beats Audio vibrates after scanning a code.
<b>GPS</b>	Tap <b>ON</b> when searching for nearby stores that sell the product. This requires Internet connection and enabled location services.
<b>Currency</b>	Choose the currency to use for product prices.



## Working on documents

Need to tweak a report while you're on the go? Use Polaris Office to easily view and edit Microsoft Office Word (.doc and .docx), Microsoft Office Excel (.xls and .xlsx), Microsoft Office PowerPoint (.ppt, .pps and .pptx), and plain text (.txt) files.

---

### Viewing a document



---

1. From the Home screen, tap  > **Polaris Office**.
2. On the Polaris Office main screen, tap the file you want to open.
3. Slide your finger on the screen to pan or go through the pages.
4. To zoom in or out, spread or pinch your thumb and index fingers across the page.
5. To view in landscape, turn HTC Rezound with Beats Audio sideways.
6. Press MENU  to see options for saving or printing the file, and more.

---

### Creating a document

---





1. From the Home screen, tap  > **Polaris Office**.
2. On the Polaris Office main screen, press MENU , and then tap **New**.
3. Choose a file type to create.
4. Start entering text.

5. When done, press MENU , and then tap **Save** (or **More > Save as**) to keep your changes.

---



## Editing a document

---

1. From the Home screen, tap  > **Polaris Office**.
2. On the Polaris Office main screen, tap the file you want to edit.
3. Do any of the following:
  - If your file is a Microsoft Office Word, a Microsoft Office PowerPoint, or a plain text document, press MENU  > **Edit**.
  - If your file is a Microsoft Office Excel document, tap a cell and then enter your changes in the text box. To choose a different worksheet, press MENU  > **Worksheet**.
4. When done making your changes, press BACK  and then tap either **Save** or **Save as**.

## Recording your voice



Don't just think out loud. Use Voice Recorder to quickly capture your thoughts. You can also record your voice and set it as a ringtone.

1. From the Home screen, tap  > **Voice Recorder**.
2. Hold the microphone near your mouth.
3. Tap  to start recording a voice clip.





Voice Recorder can run on the background while you do other things on HTC Rezound with Beats Audio, except when you open other apps that also use audio functions. To go back to the Voice Recorder screen, slide open the Notifications panel, and then tap **Voice Recorder**.

4. Tap  to stop recording.
5. Type a name for the voice clip and tap **Save**.
6. To play back the voice clip, tap .
7. To show options for sharing, deleting, or renaming the voice clip, press MENU .

---

### Setting a voice clip as a ringtone

---

1. On the Voice Recorder screen, tap .
2. Press and hold the voice clip you want to set as a ringtone, and then tap **Set as ringtone**.

---

### Managing voice clips

---

1. On the Voice Recorder screen, tap .
2. Press and hold a voice clip, and then tap an option from the menu. You can share, rename, or delete the selected voice clip.

# HTC Sync

## About HTC Sync

You have your new vacation photos on HTC Rezound with Beats Audio while your business calendar is on your computer. Why not make your files and information available on both devices?

With HTC Sync, you can:

- Sync your contacts between your Microsoft Outlook, Outlook Express or Windows Contacts on your computer and HTC Rezound with Beats Audio.
- Sync your calendar events between the Outlook or Windows Calendar on your computer and HTC Rezound with Beats Audio.
- Bring your photos, videos, documents, songs, and playlists to HTC Rezound with Beats Audio and enjoy them on the go.
- Easily import your captured photos and videos from HTC Rezound with Beats Audio to your computer.
- Store the same web bookmarks on both your computer and HTC Rezound with Beats Audio.
- Install third-party mobile apps from your computer.



You need a storage card inserted into HTC Rezound with Beats Audio to be able to sync multimedia files and documents.

## Installing HTC Sync



- HTC Sync requires USB 2.0 on your computer to connect and sync with HTC Rezound with Beats Audio.
- For trouble-free installation, first quit all running programs and temporarily exit from your anti-virus program before you start installing HTC Sync.

Download the HTC Sync software for HTC Rezound with Beats Audio from our support website ([www.htc.com/us/support/](http://www.htc.com/us/support/)) and install it on your computer.

## Setting up HTC Sync to recognize HTC Rezound with Beats Audio

1. Connect HTC Rezound with Beats Audio to your computer using the USB cable that came in the box.
2. When HTC Rezound with Beats Audio prompts you to choose a type of USB connection, tap **HTC Sync**, and then tap **Done**. Wait for HTC Sync to recognize HTC Rezound with Beats Audio.
3. On the Device setup screen, enter a name for HTC Rezound with Beats Audio.
4. Click **Save**. The Device panel then opens.



To change the name of HTC Rezound with Beats Audio later, click **Overview > Device setup**.

## Getting to know the workspace

On the Device panel, you can set your sync options, see general information about HTC Rezound with Beats Audio, check the used and available storage space, and begin synchronization.



The available categories and options depend on the device you've connected to your computer.

- You can click a category of items to see its sync options on the right side of the Device panel.

Clicking **Overview** displays basic software information and storage usage, and lets you change the name of HTC Rezound with Beats Audio, or install third-party applications to HTC Rezound with Beats Audio.

- The **Sync now** button lets you start syncing the categories and options you've selected.
- The estimated storage usage bar beside the **Sync now** button shows you the estimated storage space that will be used when there are new items to be synchronized and added to HTC Rezound with Beats Audio.

## Setting up synchronization

You can choose the types of files and information you want to sync between HTC Rezound with Beats Audio and your computer.

---

### Music sync options

---

Bring the music tracks and songs you play on your computer to HTC Rezound with Beats Audio. If you have playlists created in iTunes® or Windows Media® Player, you can sync these too and enjoy them on the go.



You can sync audio files in these formats: \*.aac, \*.amr, \*.m4a, \*.mid, \*.midi, \*.mp3, \*.wav, \*.wma

1. On the Device panel, click **Music**, and then click the **On** button. Turning Music sync on means you want this category included every time you sync your computer and HTC Rezound with Beats Audio.
2. Select **Sync music files from**, and then click **Add**.
3. Choose a folder that contains your audio files, and then click **OK**.
4. Select **Sync music files from iTunes and Windows Media Player** if you're using either of these software on your computer, and then choose the playlists you want to sync on HTC Rezound with Beats Audio.

---

## Gallery sync options

---

You can automatically sync photos and videos between HTC Rezound with Beats Audio and a computer.



You can sync photos and videos in these formats:

- Photos: \*.bmp, \*.gif, \*.jpeg, \*.jpg, \*.png
- Videos: \*.3gp, \*.3g2, \*.mp4, \*.wmv

1. On the Device panel, click **Gallery**, and then click the **On** button. Turning Gallery sync on means you want this category included every time you sync your computer and HTC Rezound with Beats Audio.
2. To automatically import your camera shots to your computer during synchronization, select **Copy device Camera Shots to PC**. Photos and videos from HTC Rezound with Beats Audio will be saved to the `\My Photos\Device Camera Shots` folder on your computer.
3. Select **Sync PC photos & videos from**, and then click **Add**.
4. Choose a folder that contains your multimedia files, and then click **OK**. All supported image and video files added to this folder will be copied to HTC Rezound with Beats Audio during synchronization.

---

## Calendar sync options

---

HTC Rezound with Beats Audio can sync appointments and events with your calendar in Outlook (Outlook XP, Outlook 2003 or Outlook 2007) or Windows Calendar.

1. On the Device panel, click **Calendar**, and then click the **On** button. Turning Calendar sync on means you want this category included every time you sync your computer and HTC Rezound with Beats Audio.
2. Select the application you want to sync calendar events with.
3. Choose from which point you want to start synchronizing your calendar events.
4. In cases when conflicting information is found on both HTC Rezound with Beats Audio and the computer, choose which information you want to keep.



Only the calendar fields supported on HTC Rezound with Beats Audio will be synchronized.

---

## People sync options

---

Sync HTC Rezound with Beats Audio contacts with your Outlook (Outlook XP, Outlook 2003 or Outlook 2007), Outlook Express, or Windows Contacts.

If you have contacts to sync from your SIM card, you have to import these first to HTC Rezound with Beats Audio storage.

1. On the Device panel, click **People**, and then click the **On** button. Turning People sync on means you want this category included every time you sync your computer and HTC Rezound with Beats Audio.
2. Choose the application you want to sync your contacts with.
3. In cases when conflicting information is found on both HTC Rezound with Beats Audio and the computer, choose which information you want to keep.



Only the contact fields supported on HTC Rezound with Beats Audio will be synchronized.



---

## Bookmarks sync options

---

Sync web browser bookmarks between HTC Rezound with Beats Audio and a computer.



If you are using Google Chrome™ or Firefox® Internet browser and have selected it to sync with HTC Rezound with Beats Audio, make sure to close all browser windows before you begin synchronization.

1. Using your favorite web browser on your computer, create a favorites folder named **HTC bookmarks**. Make sure to save your favorite bookmarks in this folder to be able to sync them with HTC Rezound with Beats Audio.
2. On HTC Sync's Device panel, click **Bookmarks**, and then click the **On** button. Turning Bookmarks sync on means you want this category included every time you sync your computer and HTC Rezound with Beats Audio.
3. Choose the web browser that stores the bookmarks to sync with HTC Rezound with Beats Audio.



When conflicting information is found on both HTC Rezound with Beats Audio and computer, HTC Sync keeps the information from your computer.

---

## Documents sync options

---

You can sync files and documents from your computer to HTC Rezound with Beats Audio. You can also sync email attachments that you stored on HTC Rezound with Beats Audio to your computer.



- To open a document on HTC Rezound with Beats Audio, you'll need a compatible app.
- To sync email attachments stored on HTC Rezound with Beats Audio to your computer, you must set up an Exchange ActiveSync or POP3/IMAP email account from the Mail app on HTC Rezound with Beats Audio.

1. On the Device panel, click **Documents**, and then click the **On** button. Turning Documents sync on means you want this category included every time you sync your computer and HTC Rezound with Beats Audio.
2. To sync email attachments that you've stored on HTC Rezound with Beats Audio, select **Copy all download Mail documents to PC**.
3. Select **Sync PC documents from**, and then click **Add**.
4. Choose a folder that contains the documents you want to sync on HTC Rezound with Beats Audio, and then click **OK**.

Email attachments will be saved on the `\My Documents\` folder.

## Synchronizing HTC Rezound with Beats Audio

Check the estimated usage bar beside the **Sync now** button for the estimated file size of new items to sync on HTC Rezound with Beats Audio.

1. After selecting and customizing the categories you want to sync, click **Sync now**.
2. After synchronization is complete, click **Disconnect**.
3. Safely remove HTC Rezound with Beats Audio as required by your computer's operating system.

The next time you connect HTC Rezound with Beats Audio to your computer, synchronization automatically begins based on your sync settings.

## Installing an app from your computer to HTC Rezound with Beats Audio

If you have application files (\*.apk) on your computer, you can use HTC Sync to install them to HTC Rezound with Beats Audio. We strongly recommend you install only applications that you trust.



Before you begin, make sure that HTC Rezound with Beats Audio is set to allow applications from your computer to be installed to HTC Rezound with Beats Audio. To do this, press **MENU**  while on the Home screen, tap **Settings** > **Applications**, and then select the **Unknown sources** check box.

1. On the Device panel, click **Overview**.

2. Click **Application installer**.
3. Browse for the application file on your computer, and then click **Open**. The installation process starts on HTC Rezound with Beats Audio.
4. Check the screen on HTC Rezound with Beats Audio to see if there are additional instructions to complete the installation.
5. After installation is complete, you can click **Disconnect**.
6. Safely remove HTC Rezound with Beats Audio as required by your computer's operating system.

## Synchronizing another device with your computer

You can switch from one device to another, if you have more than one device to sync.

1. Connect another device to your computer, then set up HTC Sync to recognize it.
2. Click the device you want to set up or begin synchronization. The Device panel then opens, where you can separately customize your sync settings for this device.

To switch to another device to sync, click **Devices**, and then click the device's name or image.



## Downloading the latest HTC Sync upgrade

Visit the HTC support website ([www.htc.com/us/support/](http://www.htc.com/us/support/)) from time to time to check for the most recent HTC Sync upgrade so you can download and install it on your computer.

After installing the latest upgrade, set up HTC Sync again to recognize and sync with HTC Rezound with Beats Audio.

# Keyboard

## Using the onscreen keyboard

When you start an app or select a field that requires text or numbers, the onscreen keyboard becomes available. After entering your text, you can tap  or press BACK  to close the onscreen keyboard.

---

### Selecting a keyboard layout

---

You can choose from three different keyboard layouts to suit your typing style.

1. From the Home screen, press MENU , and then tap **Settings** > **Language & keyboard** > **Touch Input**.
2. Tap **Keyboard types**, and then select the keyboard layout that you want to use.

<b>Standard</b>	This layout is similar to a desktop computer keyboard. This is the default keyboard layout.
<b>Phone</b>	This layout resembles the traditional mobile phone keypad.
<b>Compact</b>	This layout features two letters on each key. The key size is slightly bigger than on the Standard layout.

---

## Entering text

---

Use the following keys while entering text using the onscreen keyboard:



Press and hold keys with gray characters at the top to enter numbers, symbols, or accented letters. The gray character displayed on the key is the character that will be inserted when you press and hold that key. Some keys have multiple characters or accents associated with them.



Shift key. Tap to enter an uppercase letter. Tap twice to turn on caps lock.



Tap to switch to the numeric and symbol keyboard.



Enter key. Tap to create a new line.



Backspace key. Tap to delete the previous character.



Language and voice input key. If you've enabled the keyboard to support multiple languages, the current keyboard language is displayed on this key. Tap to switch to another keyboard language. Press and hold this key to enter text by speaking.



Tap to toggle between Multitap and XT9 predictive modes when using the Compact or Phone keyboard layout.



Tap to hide the onscreen keyboard.

---

## Enabling multiple keyboard languages

---

If there are multiple keyboard languages available on HTC Rezound with Beats Audio, you can choose which languages to enable in the onscreen keyboard so that you can switch to these languages and use them to enter text.

1. From the Home screen, press MENU , and then tap **Settings > Language & keyboard > Touch Input**.
2. Tap **International keyboard**.
3. Choose the languages you want.



Available languages depend on the region where you purchased HTC Rezound with Beats Audio.



---

## Changing to the landscape onscreen keyboard

---

When entering text, you can choose to use the landscape orientation of the onscreen keyboard. Turn HTC Rezound with Beats Audio sideways to use a larger keyboard for easy typing.



- Select the **Auto-rotate screen** check box in HOME  > MENU  > **Settings > Display** to allow the screen orientation to automatically change.
- The landscape orientation keyboard is not supported in all apps.



## Entering words with predictive text

The onscreen keyboard has predictive text to help you type quickly and accurately. Predictive text input is enabled by default, and word suggestions are displayed as you type.

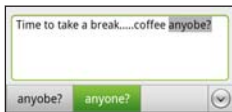

To enter a word in predictive mode, do any of the following:

- If you see the word you want highlighted in green or orange, just tap the space bar to insert the word into your text.
- If you see the word you want shown in the suggestions before you have finished typing the entire word, tap the word to insert it into your text.
- If an arrow is shown to the right of the suggestion list, tap the arrow to see more suggestions.

---

## Setting a second language for the keyboard

---

Aside from the keyboard language you are currently using, you can set the predictive text to be bilingual. As you type, you'll get word suggestions in two languages that you've selected.

1. From the Home screen, press MENU , and then tap **Settings > Language & keyboard > Touch Input**.
2. Tap **Bilingual prediction**, and then choose the language you want.



---

## Adding a word to the predictive text dictionary

---

HTC Rezound with Beats Audio comes with a list of words that it references for predictive text suggestions. While entering text using the Standard keyboard layout, if you tap any word on the suggestion list, it is automatically added to the predictive text dictionary if it was not in the dictionary already.

You can also add a word to the list manually.



1. From the Home screen, press MENU , and then tap **Settings > Language & keyboard > Touch Input**.
2. Tap **Personal dictionary > Edit personal dictionary > **.
3. Enter the word to add, and then tap **OK**.

---

## Editing or deleting a word in the predictive text dictionary

---

You can edit or remove words that you previously added to the predictive text dictionary.

1. From the Home screen, press MENU , and then tap **Settings > Language & keyboard > Touch Input**.
2. Tap **Personal dictionary > Edit personal dictionary**.
  - To edit a word, tap the word itself.
  - To delete words from the dictionary, press MENU  and tap **Delete**. Then choose the words to remove and tap **Delete**.

---

## Backing up your personal dictionary to your storage card

---

If you have a storage card installed, you can back up the new words you've added to the predictive text dictionary.

1. From the Home screen, press MENU , and then tap **Settings > Language & keyboard > Touch Input**.
2. Tap **Personal dictionary > Sync personal dictionary > Copy to storage card**.
3. When prompted, tap **OK**.

---

## Importing your personal dictionary from your storage card

---

1. From the Home screen, press MENU , and then tap **Settings > Language & keyboard > Touch Input**.
2. Tap **Personal dictionary > Sync personal dictionary > Restore from storage card**.
3. When prompted, tap **OK**.

## Entering text by speaking

No time to type? Try speaking the words to enter them in most text fields that let you use the onscreen keyboard.



- First make sure to select the language you'll be using in the **Voice input & output** settings.
- Since HTC Rezound with Beats Audio uses Google's speech-recognition service, you need to be connected to the Internet to enter text by speaking.

1. Tap the voice input key. HTC Rezound with Beats Audio cues you to speak.
2. Tell HTC Rezound with Beats Audio what you want to be typed in.

---

### Setting the voice input language

---

1. From the Home screen, press MENU , then tap **Settings > Voice input & output > Voice recognizer settings**.
2. Tap **Language**, then choose the language you want.



Available languages depend on the voice input languages supported by Google.

## Entering text by tracing

Instead of tapping the keys on the onscreen keyboard, you can “trace” to type words.

Trace keyboard in Settings > Language & keyboard > Touch Input > Trace keyboard must be selected for you to use the Trace keyboard.

To trace, slide your finger on the onscreen keyboard to enter words. For example, if you want to type “the”, put your finger on the “t” key, and then trace the word (by sliding your finger) “the” on the onscreen keyboard.



## Editing text

It's easy to cut, copy, and paste text using the keyboard.



Some apps may offer their own way of selecting or copying text.

---

### Selecting text

---

Highlight the text that you want to copy or cut.

1. Do one of the following:
  - Select a word. Press and hold the word. If you've selected the wrong word, drag the markers to the correct word.
  - Select a phrase or sentence. Press and hold the first word of the phrase or sentence that you want to select and then drag the end marker to the rest of the text.
  - Select all text. Press and hold on a word, and then tap **Select all** to select all text in the field.
2. After highlighting the text, lift your finger.

---

### Copying and pasting text



---

1. After you have selected the text you want to copy, tap **Copy** or **Cut**. The selected text is then copied to the clipboard.
2. Press and hold a text field in the same or other app until the magnifier appears.

3. Drag your finger to move the text cursor to where you want to paste the text.
4. After positioning the text cursor, lift your finger. The text selection menu then pops up.
5. Tap **Paste**.

## Adjusting input settings

Open the Touch Input settings by doing one of the following:

- From the Home screen, press MENU , and then tap **Settings > Language & keyboard > Touch Input**.
- On the onscreen keyboard, tap the language key (for example, tap  if you're currently using the English onscreen keyboard). Then on the International keyboard options menu, tap **Settings**.



You must have more than two keyboard languages selected before you can access Touch Input settings using the language key.

<b>Keyboard types</b>	Select the keyboard layout to use.
<b>International keyboard</b>	Add or remove languages from the onscreen keyboard language list.
<b>Bilingual prediction</b>	Select a secondary keyboard language to use.

<b>Text input</b>	<ul style="list-style-type: none"><li>▪ Turn on or off predictive text, spell correction, and word completion.</li><li>▪ Enable audible or vibration feedback when typing.</li><li>▪ Calibrate the touch keyboard accuracy.</li></ul>
<b>Chinese text input</b>	Set options for the Chinese input methods.
<b>Tutorial</b>	Learn how to use the onscreen keyboard with this interactive tutorial.
<b>Trace keyboard</b>	Turn on Trace keyboard and set options when tracing to enter text.
<b>Personal dictionary</b>	Add, edit, or remove words in the predictive text dictionary.



# Internet connections

## Data connection

When you turn on HTC Rezound with Beats Audio for the first time, it will be automatically set up to use the mobile network of Verizon Wireless (if the SIM card is inserted).

---

### Turning the data connection on or off

---

Turning your data connection off can help save battery life and save money on data charges. However, if you don't have data connection turned on and you're also not connected to a Wi-Fi network, you won't receive automatic updates to your email, social network accounts, and other synchronized information.

1. From the Home screen, press MENU , and then tap **Settings > Wireless & networks**.
2. Select the **Mobile network** check box to turn on the data connection; clear the check box to turn off the data connection.

---

## Enabling data roaming

---

Connect to partner networks of Verizon Wireless and access data services when you're out of Verizon Wireless coverage areas.



You may incur significant data charges while roaming. Check with Verizon Wireless for data roaming rates before you use data roaming.

1. From the Home screen, press MENU , and then tap **Settings > Wireless & networks**.
2. Tap **Mobile networks > Data roaming**.
3. Select **Allow access for all trips** or **Allow access only for this trip**.

Select the **Data roaming sound** check box if you'd like HTC Rezound with Beats Audio to play a sound so you'll know when it's connecting to a roaming network.

## Wi-Fi

To use Wi-Fi, you need access to a wireless access point or “hotspot”. The availability and strength of the Wi-Fi signal will vary depending on objects, such as buildings or simply a wall between rooms, the Wi-Fi signal has to pass through.

---

## Turning Wi-Fi on and connecting to a wireless network

---

1. From the Home screen, press MENU , and then tap **Settings > Wireless & networks**.

2. Select the **Wi-Fi** check box to turn Wi-Fi on.  
HTC Rezound with Beats Audio then scans for available wireless networks.
3. Tap **Wi-Fi settings**.  
Detected Wi-Fi networks will be listed in the Wi-Fi networks section.



If the wireless network that you want is not listed, tap **Add Wi-Fi network** to manually add it.

4. Tap the Wi-Fi network you want to connect to.



If you selected a secured network, you'll be asked to enter the network key or password.

5. Tap **Connect**.

When HTC Rezound with Beats Audio is connected to the wireless network, the Wi-Fi icon  appears in the status bar and tells you the approximate signal strength (number of bands that light up).

The next time HTC Rezound with Beats Audio connects to a previously accessed secured wireless network, you won't be asked to enter the key or other security information again, unless you reset HTC Rezound with Beats Audio to its factory default settings.

---

## Wi-Fi Enhanced Connectivity

---

When you're using an app that needs to connect to the Internet, HTC Rezound with Beats Audio automatically scans for available Wi-Fi networks even if the Wi-Fi check box in Wireless & networks settings is not selected.



Connecting to the Internet using Wi-Fi saves you data transfer fees.

- When prompted, tap a Wi-Fi network to connect to, and then tap **Connect**. If you selected a secured network, you'll be asked to enter the network key or password.
- If you don't want to connect to a Wi-Fi network, tap **Turn off Wi-Fi but remind me later**. To disable the Wi-Fi Enhanced Connectivity feature, tap **Do not automatically turn on Wi-Fi**.

---

## Connecting to a Wi-Fi network with EAP-TLS security

---

You may need to install a network certificate (\*.p12) to HTC Rezound with Beats Audio before you can connect to a Wi-Fi network with EAP-TLS authentication protocol.

1. Save the certificate file to the root folder of the storage card.
2. From the Home screen, press MENU , and then tap **Settings > Security**.
3. Tap **Install from SD card**.
4. Select the network certificate needed to connect to the EAP-TLS network.

5. Turn on Wi-Fi and connect to a wireless network.

---

## Checking the wireless network status

---

1. From the Home screen, press MENU , and then tap **Settings > Wireless & networks**.
2. On the Wireless & networks screen, tap **Wi-Fi settings**, and then tap the wireless network that HTC Rezound with Beats Audio is currently connected to.

A message box is then displayed showing the Wi-Fi network name, status, speed, signal strength, and more.





If you want to remove the settings for this network, tap **Forget**. If you want to reconnect to a wireless network that you have removed, you'll need to choose the wireless network from the list of available Wi-Fi networks again. If it is a secured wireless network, you'll need to enter the wireless network credentials again.

---

## Connecting to another Wi-Fi network

---

1. From the Home screen, press MENU , and then tap **Settings > Wireless & networks**.
2. Tap **Wi-Fi settings**. Detected Wi-Fi networks are displayed in the Wi-Fi networks section.
3. To manually scan for available Wi-Fi networks, on the Wi-Fi screen, press MENU , and then tap **Scan**.

4. Tap another Wi-Fi network to connect to it.

## Connecting to a virtual private network (VPN)

Add, set up, and manage virtual private networks (VPNs) so you can connect and access resources inside a secured local network, such as your corporate network.

Depending on the type of VPN you're using at work, you may be asked to enter your login credentials and install security certificates before you can connect to your company's local network. You can get this information from your network administrator.

Also, HTC Rezound with Beats Audio must first establish a Wi-Fi or data connection before you can start a VPN connection.

---

### Setting up secure credential storage

---

If your network administrator tells you to download and install security certificates, you must first set up secure credential storage on HTC Rezound with Beats Audio.



1. From the Home screen, press MENU , and then tap **Settings > Security**.
2. Tap **Set password**.
3. Enter a new password for the credential storage.
4. Scroll down and confirm the password, and then tap **OK**.
5. Select the **Use secure credentials** check box.

You can then download and install the certificates needed to access your local network. Your network administrator can tell you how to do this.

---

### Adding a VPN connection

---



1. From the Home screen, press MENU , and then tap **Settings** > **Wireless & networks**.
2. Tap **VPN settings** > **Add VPN**, and then tap the type of VPN you want to add.
3. Tap the VPN settings and set them up according to the security details your network administrator gave you.
4. Press MENU , and then tap **Save**.

The VPN is then added to the VPNs section of the VPN settings screen.

---

### Connecting to a VPN

---

1. From the Home screen, press MENU , and then tap **Settings** > **Wireless & networks**.
2. Tap **VPN settings**.
3. In the VPNs section, tap the VPN that you want to connect to.
4. When asked, enter your log in credentials, and then tap **Connect**. When you're connected, the VPN connected icon  appears in the notification area of the title bar.

You can then open the web browser to access resources such as your corporate network intranet.

---

## Disconnecting from a VPN

---

1. Press and hold the title bar, and then slide down your finger to open the Notifications panel.
2. Tap the VPN connection to return to the VPN settings screen, and then tap the VPN connection to disconnect from it.

When HTC Rezound with Beats Audio has disconnected from the VPN, the VPN disconnected icon  is displayed in the notification area of the title bar.

## Using HTC Rezound with Beats Audio as a modem (USB tethering)

No Internet connection available for your computer? No problem. Use the Internet connection of HTC Rezound with Beats Audio to connect to the Internet.



- You need your SIM card inserted on HTC Rezound with Beats Audio to use the data connection.
  - To use HTC Rezound with Beats Audio as a modem, you need to install HTC Sync on your computer first.
  - You must have an approved data plan to use this service.
1. Make sure the data connection on HTC Rezound with Beats Audio is turned on.
  2. Connect HTC Rezound with Beats Audio to the computer using the provided USB cable.



3. On the Choose a connection type screen, select **Internet Connection Mode**, and then tap **Done**.

## Connecting HTC Rezound with Beats Audio to the Internet through a computer (Internet Pass-through)

If you temporarily don't have Internet access, you can still go online on HTC Rezound with Beats Audio by using your computer's Internet connection.



Before you can use your computer as a modem, be sure to install HTC Sync on your computer first.

1. Make sure your computer is connected to the Internet.



Two things to check for your computer's Internet connection. One, you may need to turn off your local network's firewall. Two, if your computer connects to the Internet via PPP (e.g. Dial UP, xDSL, or VPN), Internet Pass-through will only support TCP protocol.

2. Connect HTC Rezound with Beats Audio to the computer using the provided USB cable.
3. On the Choose a connection type screen, select **Internet pass-through**, and then tap **Done**.

## Using HTC Rezound with Beats Audio as a wireless router

Share your data connection with other devices by turning HTC Rezound with Beats Audio into a wireless router.



- Make sure the data connection on HTC Rezound with Beats Audio is turned on before you use it as a wireless router.
- You must have an approved data plan to use this service.

1. From the Home screen, press MENU , and then tap **Settings > Wireless & networks**.
2. Tap **Mobile Hotspot settings**.
3. Enter a router name or use the default router name.
4. Choose the type of Security and set the password (key) for your wireless router. If you selected **None** in Security, you don't need to enter a password.



The password is the key other people need to enter on their device so they can connect and use HTC Rezound with Beats Audio as a wireless router.

5. Select the **Mobile Hotspot** check box to turn on the wireless router.

HTC Rezound with Beats Audio is ready to be used as a wireless router when you see  on the status bar.

# Bluetooth

## Bluetooth basics

---

### Turning Bluetooth on or off

---

1. From the Home screen, press MENU , and then tap **Settings > Wireless & networks**.
2. Select or clear the **Bluetooth** check box.

An even easier way to turn Bluetooth on or off is with the Bluetooth widget on the Home screen.



Turn off Bluetooth when not in use to save battery power, or in places where using a wireless device is prohibited, such as on board an aircraft and in hospitals.

---

### Changing the device name

---

The device name identifies HTC Rezound with Beats Audio to other devices.

1. From the Home screen, press MENU , and then tap **Settings > Wireless & networks**.
2. Tap **Bluetooth settings**.

3. If the **Bluetooth** check box is not selected, select it to turn Bluetooth on.
4. Tap **Device name**.
5. Enter the new name for HTC Rezound with Beats Audio in the dialog box, and then tap **OK**.

## Connecting a Bluetooth headset or car kit

You can listen to music over a Bluetooth stereo headset, or have hands-free conversations using a compatible Bluetooth headset or car kit. It's the same procedure to set up stereo audio and hands-free.



- For you to listen to music with your headset or car kit, the headset or car kit must support the A2DP Bluetooth profile.
- Before you connect your headset, you need to make it discoverable so HTC Rezound with Beats Audio can find it. You can find out how to do this by referring to your headset manual.

1. From the Home screen, press MENU , and then tap **Settings > Wireless & networks**.
2. Tap **Bluetooth settings**.
3. If the **Bluetooth** check box is not selected, select it to turn Bluetooth on.
4. Make sure that the headset is discoverable.
5. Tap **Scan for devices**. HTC Rezound with Beats Audio will start to scan for Bluetooth devices within range.

6. When you see the name of your headset displayed in the Bluetooth devices section, tap the name. HTC Rezound with Beats Audio then automatically tries to pair with the headset.
7. If automatic pairing fails, enter the passcode supplied with your headset.

The pairing and connection status is displayed below the hands-free headset or car kit name in the Bluetooth devices section. When the Bluetooth headset or car kit is connected to HTC Rezound with Beats Audio, the Bluetooth connected icon  is displayed in the status bar. Depending on the type of headset or car kit you have connected, you can then start using the headset or car kit.

---

### Reconnecting a headset or car kit

---

Normally, you can easily reconnect your headset by switching on Bluetooth on HTC Rezound with Beats Audio, and then turning on the headset. However, you might have to connect manually if your headset has been used with another Bluetooth device.

1. From the Home screen, press MENU , and then tap **Settings > Wireless & networks**.
2. Tap **Bluetooth settings**.
3. If the **Bluetooth** check box is not selected, select it to turn Bluetooth on.
4. Make sure that the headset is discoverable.
5. Tap the headset's name in the Bluetooth devices section.
6. If prompted to enter a passcode, try 0000 or 1234, or consult the headset/car kit documentation to find the passcode.

If you still cannot reconnect to the headset or car kit, follow the instructions in [Unpairing from a Bluetooth device](#) on page 310, and then follow the steps under [Connecting a Bluetooth headset or car kit](#) on page 308.

## Disconnecting or unpairing from a Bluetooth device

---

### Disconnecting a Bluetooth device

---

1. From the Home screen, press MENU , and then tap **Settings** > **Wireless & networks**.
2. Tap **Bluetooth settings**.
3. In the Bluetooth devices section, press and hold the device to disconnect.
4. Tap **Disconnect**.

---

### Unpairing from a Bluetooth device

---

You can make HTC Rezound with Beats Audio forget its pairing connection with another Bluetooth device. Doing so may require you to enter or confirm a passcode again if you want to reconnect to the other device.

1. From the Home screen, press MENU , and then tap **Settings** > **Wireless & networks**.
2. Tap **Bluetooth settings**.
3. In the Bluetooth devices section, press and hold the device to unpair.

4. Tap **Disconnect & unpair**, or tap **Unpair** if the Bluetooth device is currently not connected to HTC Rezound with Beats Audio.

## Sending information using Bluetooth

You can use Bluetooth to send information from HTC Rezound with Beats Audio to another Bluetooth enabled device such as a phone or notebook computer. You can send the following types of information, depending on the device you are sending to:



- Images and videos
- Calendar events
- Contacts
- Audio files

**F** Before you begin, set the receiving device to discoverable mode. You may also need to set it to “Receive Beams” or “Receive Files”. Refer to the device’s documentation for instructions on receiving information over Bluetooth.

1. On HTC Rezound with Beats Audio, open the app that contains the information or file you want to send.
2. Follow the steps for the type of item you want to send:

**Captured photo  
or video**

After capturing, on the Camera preview screen, tap , and then tap **Bluetooth**.

<b>Photos or videos</b>	<ol style="list-style-type: none"><li>1. On the Gallery app, choose an album.</li><li>2. Tap <b>Share</b> &gt; <b>Bluetooth</b>.</li><li>3. Choose the photos and videos you want to share, and then tap <b>Next</b>.</li></ol>
<b>Contact</b>	<ol style="list-style-type: none"><li>1. On the People app, tap a contact to view the contact's details.</li><li>2. Press MENU  and then tap <b>Send contact</b>.</li><li>3. Tap the down arrow icon, and then select <b>Bluetooth</b>.</li><li>4. Choose which details to share, and then tap <b>Send</b>.</li></ol>
<b>Calendar appointment or event</b>	In Day view, Agenda view, or Week view, press and hold the event, and then tap <b>Forward</b> > <b>Bluetooth</b> .
<b>Music track</b>	<ol style="list-style-type: none"><li>1. With the track displayed on the Music app's Now playing screen, tap  &gt; <b>Share</b> &gt; <b>Share file</b>.</li><li>2. Tap <b>Bluetooth</b>.</li></ol>
<b>Voice recording</b>	On the main Voice Recorder screen, tap  , and then tap <b>Bluetooth</b> .

3. Turn on Bluetooth if you're asked to do so.
4. If you haven't paired with the receiving device before, tap **Scan for devices**.



5. Tap the name of the receiving device.
6. If prompted, accept the pairing request on HTC Rezound with Beats Audio and on the receiving device. Also enter the same passcode or confirm the auto-generated passcode on both devices.
7. On the receiving device, accept the file.

---

### Where sent information is saved

---

When you send information using Bluetooth, the location where it's saved depends on the type of information and the receiving device.

If you send a calendar event or contact, it is normally added directly to the corresponding application on the receiving device. For example, if you send a calendar event to a compatible phone, the event is shown in that phone's calendar application.

If you send another file type to a Windows computer, it is normally saved in the Bluetooth Exchange folder within your personal document folders.

- On Windows XP, the path may be: `C:\Documents and Settings\[your username]\My Documents\Bluetooth Exchange`
- On Windows Vista, the path may be: `C:\Users\[your username]\Documents`
- On Windows 7, the path may be: `C:\Users\[your username]\My Documents\Bluetooth Exchange Folder`

If you send a file to another device, the saved location may depend on the file type. For example, if you send an image file to another mobile phone, it may be saved in a folder named "Images".

## Receiving information using Bluetooth

HTC Rezound with Beats Audio lets you receive various files with Bluetooth, including photos, music tracks, and documents such as PDFs.

1. From the Home screen, press MENU , and then tap **Settings** > **Wireless & networks**.
2. Tap **Bluetooth settings**.
3. If the **Bluetooth** check box is not selected, select it to turn Bluetooth on.
4. Select the **Discoverable** check box.
5. On the sending device, send one or more files to HTC Rezound with Beats Audio. Refer to the device's documentation for instructions on sending information over Bluetooth.
6. If asked, accept the pairing request on HTC Rezound with Beats Audio and on the receiving device. Also enter the same passcode or confirm the auto-generated passcode on both devices.  
You'll then get a Bluetooth authorization request.
7. If you want to automatically receive files from the sending device in future, select the **Always** check box.
8. Tap **Accept** or **OK**.
9. When HTC Rezound with Beats Audio receives a file transfer request notification, slide down the Notifications panel, tap the incoming file notification, and then tap **Accept**.
10. When a file is transferred, a notification is displayed. To open the file immediately, slide down the Notifications panel, and then tap the relevant notification.

When you open a received file, what happens next depends on the file type:

- Media files and documents are usually opened directly in a compatible app. For example, if you open a music track, it starts playing in the Music app.
- For a vCalendar file, choose the calendar where you want to save the event, and then tap **Import**. The vCalendar is added to your Calendar events.
- For a vCard contact file, you can choose to import one, several, or all of those contacts to your contacts list.

---

### Adding the Bluetooth received folder to the Home screen

---

You can add a folder to the Home screen that shows all files you have received with Bluetooth.

1. From the Home screen, tap .
2. On the Personalize screen, tap **Folder > Bluetooth received**.
3. Press and hold the Bluetooth received folder icon, and drag it to the Home screen position you want.

To view the folder contents, tap the folder icon. To open a file, tap the file name.

# Security

## Protecting your SIM card with a PIN

Add another layer of security for HTC Rezound with Beats Audio by assigning a PIN (personal identification number) to your SIM.

Your default SIM PIN is 1111.

1. From the Home screen, press MENU , and then tap **Settings > Security**.
2. Tap **Set up SIM card lock**, then select **Lock SIM card**.
3. Enter the default SIM card PIN, and then tap **OK**.
4. To change the SIM card PIN, tap **Change SIM PIN**.

---

## Restoring a SIM card that has been locked out

---

If you enter the wrong PIN more times than the maximum number of attempts allowed, your SIM card will become “PUK-locked.”

You need a PUK code to restore access to HTC Rezound with Beats Audio. To obtain your PUK code, please contact Verizon Wireless customer service.

1. On the Phone dialer screen, enter the PUK code, and then tap **Next**.
2. Enter the new PIN you want to use, and then tap **Next**.
3. Enter the new PIN again, and then tap **OK**.

## Protecting HTC Rezound with Beats Audio with a screen lock pattern, PIN, or password

Protect your personal information and prevent others from using HTC Rezound with Beats Audio without your permission by setting a screen lock pattern, PIN or password.

Your screen lock will be asked every time HTC Rezound with Beats Audio is turned on or when it's idle for a certain period of time.

1. From the Home screen, press MENU , and then tap **Settings > Security**.
2. Tap **Set up screen lock**.
3. Tap one of the following:

<b>None</b>	Disable the screen lock you've previously created.
<b>Pattern</b>	Set a screen lock pattern by following the onscreen instructions.
<b>PIN</b>	Set a numeric password of at least four digits.
<b>Password</b>	Set an alpha-numeric password.

4. On the Security screen, tap **Lock phone after**, then specify the idle time you can allow before the screen is locked.



You can also clear the **Use visible pattern** or **Visible passwords** on the Security screen if you don't want your screen lock to display as you enter it onscreen.

---

## Changing your screen lock

---

1. From the Home screen, press MENU , and then tap **Settings** > **Security**.
2. Tap **Change screen lock**.
3. Enter your current screen lock to confirm that you want to change it.
4. Choose a different screen lock type, then enter your new pattern, PIN, or password. Or tap **None** if you don't want to use a screen lock.

## Forgot your screen lock pattern?

If you've forgotten your screen lock pattern, you have up to five attempts to try and unlock HTC Rezound with Beats Audio.

If this fails, you can unlock HTC Rezound with Beats Audio by entering your Google Account user name and password.

1. On the unlock screen, enter your lock pattern.
2. After the fifth attempt, when you're asked to wait for 30 seconds, tap **OK**.
3. If the display goes off, press the **POWER/LOCK** button to turn the display back on, and then unlock the screen.
4. Tap the **Forgot pattern?** button when it appears.
5. Enter your Google Account name and password, and then tap **Sign in**. You'll then be asked to create a new screen lock pattern. If you no longer want to do so, tap **Cancel**.

## Encrypting data on HTC Rezound with Beats Audio

You can encrypt data on HTC Rezound with Beats Audio such as your online accounts, settings, and other information.

1. From the Home screen, press **MENU** , and then tap **Settings**.

2. Tap **SD & phone storage**.
3. Under **Internal storage**, tap **Storage encryption**.



You can also encrypt files and data saved on your storage card.

4. Set a password, and then tap **OK**. The encryption process starts.

If you want to stop encrypting new information on HTC Rezound with Beats Audio, deselect the **Storage encryption** checkbox.

## Backing up your contacts

Your phone features Verizon Backup Assistant, which automatically backs up your contacts to an online server. You must first create an account on the website. If you did not set up Backup Assistant when you first turned on your phone, you can set it up in **Settings**.

---

### Setting up Backup Assistant

---

If you did not set up Backup Assistant during when you first turned on your phone, you can enable it in **Settings**.

1. From the Home screen, press **MENU** , and then tap **Settings > Accounts & sync**.
2. Tap **Backup Assistant**.
3. Follow the instructions on the screen to sign in to Backup Assistant and back up your contacts.



---

## Changing the backup schedule

---

1. From the Home screen, press MENU , and then tap **Settings > Accounts & sync**.
2. Tap **Backup Assistant**.
3. Tap **Schedule** and select a backup option from the menu.

---

## Manually backing up your contacts

---

1. From the Home screen, press MENU , and then tap **Settings > Accounts & sync**.
2. Tap **Backup Assistant**.
3. Tap **Sync now**.

For more information on how to create a Backup Assistant account and how to use it, go to: <http://support.vzw.com>.

# Settings

## Settings on HTC Rezound with Beats Audio

Control and customize phone settings on the Settings screen. From the Home screen, press MENU , and then tap **Settings**.

<b>Personalize</b>	Make HTC Rezound with Beats Audio truly yours with the various personalization options available.
<b>Wireless &amp; networks</b>	Set up wireless connections, such as Wi-Fi, data connection, and Bluetooth, enable Airplane mode, and more.
<b>Call</b>	Set up call services such as voicemail and change other phone settings.
<b>Sound</b>	<ul style="list-style-type: none"><li>▪ Choose sounds to use for the ringtones and notifications.</li><li>▪ Adjust media playback volume.</li><li>▪ Set to lower the ring volume when you move HTC Rezound with Beats Audio when it's ringing, make it ring louder when inside a bag or pocket, and turn on the speakerphone when you flip it over.</li></ul>
<b>Display</b>	Set up display settings such as automatic screen orientation, brightness, screen timeout, and more.

<b>Accounts &amp; sync</b>	<ul style="list-style-type: none"><li>▪ Log in or out of your social network accounts, Google Account, and Exchange ActiveSync account.</li><li>▪ You can also manage synchronization and other settings for your accounts.</li></ul>
<b>Location</b>	Select the sources to use when determining your location.
<b>Search</b>	Select items to include when you do a search and set Google search options.
<b>Privacy</b>	<ul style="list-style-type: none"><li>▪ Choose to automatically back up some settings (e.g. Wi-Fi passwords or Bookmarks) to Google servers using your Google Account so you can restore them when needed.</li><li>▪ If you don't want missed calls and your received text message appear on the lock screen, clear the Display message text check box.</li></ul>
<b>Connect to PC</b>	<ul style="list-style-type: none"><li>▪ Set the default USB connection type to use whenever you connect HTC Rezound with Beats Audio to your computer.</li><li>▪ Or, select the Ask me check box to set HTC Rezound with Beats Audio to always display the screen for selecting the USB connection type.</li></ul>
<b>Security</b>	Set a screen lock, enable the SIM card lock, or manage the credential storage.

## Power

- Turn on power saver to automatically switch to power saving mode when the battery level goes down to the level that you set.
- Another power saving option is to select **Enable sleep mode**. This will turn off auto sync of data in your online accounts.

## Applications

- Manage running applications, move applications to or from the storage card, check how much storage is used by apps, and install or uninstall programs.
- Choose how much free memory remains before you're notified about low memory space.

## SD & phone storage

- Check the available space in the phone and internal storage and your storage card.
- From this screen, be sure to unmount your storage card before you remove it from HTC Rezound with Beats Audio.
- Erase the phone storage or storage card content. You need to unmount the storage card first before you can erase it.
- Clear out the cache used by apps, move apps or uninstall apps if HTC Rezound with Beats Audio is running low on memory.
- You can also do a factory reset.

Date & time	<ul style="list-style-type: none"><li>▪ Set the date and time, time zone, and date or time format.</li><li>▪ Choose the time and date formats that suit you.</li></ul>
Language & keyboard	Set the operating system language and region. You can also set onscreen keyboard options.
Accessibility	Use these settings when you've downloaded and installed an accessibility tool, such as a screen reader that provides voice feedback. You can turn accessibility functions or services on or off.
Voice input & output	Set up the voice input options. Also, if you've installed a text-to-speech (voice data) application, use this to set the text-to-speech settings.
Software updates	Turn on or off scheduled checks for system software updates, or manually check for updates.
About phone	<ul style="list-style-type: none"><li>▪ Turn Tell HTC on or off. When enabled, you're helping us know if HTC Rezound with Beats Audio encounters a technical problem.</li><li>▪ View different information about HTC Rezound with Beats Audio, such as the mobile network type, signal strength, battery level, and more.</li></ul>

## Changing display settings

---

### Adjusting the screen brightness manually

---

1. From the Home screen, press MENU , and then tap Settings.

2. Tap **Display > Brightness**.
3. Clear the **Automatic brightness** check box.
4. Drag the brightness slider to the left to decrease or to the right to increase the screen brightness.
5. Tap **OK**.

---

### Adjusting the time before the screen turns off

---

After a period of inactivity, the screen turns off to conserve battery power. You can set the idle time before the screen turns off.

1. From the Home screen, press **MENU** , and then tap **Settings**.
2. Tap **Display > Screen timeout**.
3. Tap the time before the screen turns off.

---

### Turning automatic screen rotation off

---

By default, the screen orientation automatically adjusts depending on how you hold HTC Rezound with Beats Audio.



Automatic rotation is not supported in all application screens.

1. From the Home screen, press **MENU** , and then tap **Settings**.
2. Tap **Display**.
3. Clear the **Auto-rotate screen** check box.

---

## Recalibrating the G-sensor

---

Recalibrate the screen if you feel that the screen orientation does not respond properly to the way you hold HTC Rezound with Beats Audio.

1. From the Home screen, press MENU , and then tap **Settings**.
2. Tap **Display > G-Sensor calibration**.
3. Place HTC Rezound with Beats Audio on a flat and level surface, and then tap **Calibrate**.
4. After the recalibration process, tap **OK**.

---

## Keeping the screen on while charging HTC Rezound with Beats Audio

---

You can keep the screen from turning off while you're charging HTC Rezound with Beats Audio.

1. From the Home screen, press MENU , and then tap **Settings**.
2. Tap **Applications > Development**.
3. Select the **Stay awake** check box.

## Changing sound settings

---

### Switching between silent, vibration, and normal modes

---

Do one of the following:

- To change back from silent to normal mode, simply press the VOLUME UP button.
- To change back from vibration to normal mode, press the VOLUME UP button twice.
- From the Home screen, press MENU , and then tap **Settings** > **Sound** > **Sound profile**.



Add the Profile widget to your Home screen to quickly switch between modes.

---

### Enabling or disabling audible selection

---

You can choose to play a sound when you're selecting items onscreen.

1. From the Home screen, press MENU , and then tap **Settings**.
2. Tap **Sound**.
3. Select or clear the **Audible selection** check box.

---

### Lowering the ring volume automatically

---

HTC Rezound with Beats Audio has a quiet ring feature that automatically lowers the ring volume when you move it.

1. From the Home screen, press MENU , and then tap **Settings**.



2. Tap **Sound**.
3. Select or clear the **Quiet ring on pickup** check box.

---

### Making HTC Rezound with Beats Audio ring louder with Pocket mode

---

To help avoid missing incoming calls when HTC Rezound with Beats Audio is in your pocket or bag, the pocket mode feature gradually increases the ring volume and vibrates when you receive a call. When not in your pocket or bag, HTC Rezound with Beats Audio will ring at the normal volume you set.

1. From the Home screen, press MENU , and then tap **Settings**.
2. Tap **Sound**.
3. Select or clear the **Pocket mode** check box.

---

### Switching to speakerphone automatically

---



When you're on a call, you can switch to speakerphone by simply flipping HTC Rezound with Beats Audio over.

1. From the Home screen, press MENU , and then tap **Settings**.
2. Tap **Sound**.
3. Select or clear the **Flip for speaker** check box.

## Changing the language

When you turn HTC Rezound with Beats Audio on for the first time, you're asked to choose the language you want to use. If you want, you can still change the language after you set up HTC Rezound with Beats Audio. Changing the language adjusts the keyboard layout, date and time formatting, and more.

The languages available to choose from may depend on the version of HTC Rezound with Beats Audio you have.

1. From the Home screen, press MENU , and then tap **Settings**.
2. Tap **Language & keyboard > Select language**.
3. Tap the language and corresponding region you want to use.
4. Press HOME  to return to the Home screen. The new language will be applied after a few seconds.

## Optimizing battery life

You can set HTC Rezound with Beats Audio to automatically switch to power saver mode when the battery level reaches a certain level.

1. From the Home screen, press MENU , and then tap **Settings**.
2. Tap **Power**.
3. Tap **Power mode > Economy**.
4. Tap **Turn power saver on at**, and then select when to switch to power saver mode.

5. Tap **Economy mode settings**, and then set and select the behavior when HTC Rezound with Beats Audio switches to power saver mode.

---

## Checking the power usage of applications

---

1. From the Home screen, press MENU , and then tap **Settings**.
2. Tap **About phone > Battery > Battery use**.

---

## Scheduling HTC Rezound with Beats Audio to switch to Sleep mode

---

Set the Sleep mode schedule on HTC Rezound with Beats Audio so it doesn't consume too much battery power when it's not plugged in at night.

 Unlike the usual Sleep mode when you press the POWER/LOCK button to turn off the screen display, a scheduled Sleep mode turns off the Wi-Fi and data connections during the Sleep mode schedule you defined.

1. From the Home screen, press MENU , and then tap **Settings**.
2. Tap **Power > Enable sleep mode**.

3. Tap any of the following:

<b>Automatic</b>	Select to automatically switch HTC Rezound with Beats Audio to Sleep mode. HTC Rezound with Beats Audio adjusts its Sleep mode schedule over a period of time around what it detects as your bedtime.
<b>Manual</b>	Select to specify the Sleep mode start and end time.
<b>Never</b>	Select to turn scheduled Sleep mode off.

## Managing memory

---

### Checking how much phone memory is available for use

---

1. From the Home screen, press MENU , and then tap **Settings**.
2. Tap **SD & phone storage**. The available phone memory is displayed in the Internal storage section.

---

### Checking the available storage card space

---

1. From the Home screen, press MENU , and then tap **Settings**.
2. Tap **SD & phone storage**. The total and available storage card space is displayed in the SD card section.

---

## Making more storage space (internal storage)

---

Easily free up space in internal storage by cleaning up the application cache, moving or uninstalling apps, and deleting old mails and messages all in one go.



You cannot move or uninstall preinstalled apps.

1. From the Home screen, press MENU , and then tap **Settings**.
2. Tap **SD & phone storage**, and under Internal storage tap **Make more space**.
3. On the Clear caches screen, choose whether to clear the cache of rarely used apps only or all apps, and then tap **Next**.
4. On the Application storage screen:
  - Tap **Move apps to SD card** if there are apps that you can transfer to the storage card.
  - Tap **Uninstall apps** if there are apps you'd like to remove.
5. Tap **Next**.
6. On the Mail & message storage screen:
  - Set fewer days of mails to download so that older mails will be removed from the storage automatically.
  - Lower the number of text and multimedia messages per conversation.
7. Tap **Finish**.

## Clearing application cache and data

You can delete the data or clear the cache per application.

1. From the Home screen, press MENU , and then tap **Settings**.
2. Tap **Applications > Manage applications**.
3. On the All tab, tap an application.
4. On the screen, tap **Clear data** and/or **Clear cache**.

## Uninstalling an app



You cannot uninstall an app that's preinstalled on HTC Rezound with Beats Audio.

1. From the Home screen, press MENU , and then tap **Settings**.
2. Tap **Applications > Manage applications**.
3. On the Downloaded tab, tap the application you want to uninstall.
4. Tap **Uninstall**.

## Moving an app to or from the storage card



You cannot move an app that's preinstalled on HTC Rezound with Beats Audio.

1. From the Home screen, press MENU , and then tap **Settings**.



1. Tap **Applications > Manage applications**.
3. On the **Downloaded** tab, tap the application you want to move.
4. Choose whether to move the application to the storage card or to **HTC Rezound with Beats Audio**.

---

## Stopping running applications using Task Manager

---

Use Task Manager to free up memory by stopping running applications that you're not currently using.

1. From the Home screen, tap  > **Task Manager**.
2. In the All applications list, tap  to the right of the application name to stop it.

## Checking information about HTC Rezound with Beats Audio

1. From the Home screen, press **MENU** , and then tap **Settings**.
2. Tap **About phone**.

## 3. Select one of the following:

<b>Tell HTC</b>	Turn <b>Tell HTC</b> on or off. When enabled, you're helping us know if HTC Rezound with Beats Audio encounters a technical problem. You can also choose when you want to send error reports.
<b>Network</b>	Check information about your mobile network and its service status.
<b>Phone identity</b>	Check information about HTC Rezound with Beats Audio.
<b>Battery</b>	Check information about the battery such as its current battery level, status, and what programs are using the battery.
<b>Hardware information</b>	Check the Wi-Fi MAC and Bluetooth addresses.
<b>Software information</b>	Check the version and other information about the Android platform being used by HTC Rezound with Beats Audio. You can also check the version of the web browser.
<b>Legal information</b>	Read legal information from HTC and Google, and licenses used by HTC Rezound with Beats Audio.



# Update and reset

## Software updates

From time to time, software updates for HTC Rezound with Beats Audio may be available. HTC Rezound with Beats Audio can check and then notify you if there's a new update. You can then download and install the software update using the Wi-Fi or data connection. You can also manually check if there's an available software update.

Depending on the type of update, the update may erase all your personal data and customized settings, and also remove any applications you've installed. Make sure that you've backed up the information and files you want to keep.



Checking and downloading software updates may incur extra data fees.

---

## Installing an update

---

When the Internet connection is on and there's a new update available, the system update dialog box appears and guides you through the process.

1. If you don't see the dialog box, check for the update notification icon  in the status bar.  
Slide open the Notifications panel, and then tap the update notification.

2. In the system update dialog box, choose what type of connection to use for downloading the update.  
Follow the onscreen prompts to start the download.
3. After the download is complete, tap **Install now** and then tap **OK** in the Install system software update dialog box.

Wait for the update to finish. HTC Rezound with Beats Audio will then restart automatically.

---

### Checking for updates manually

---

1. From the Home screen, press MENU , and then tap **Settings**.
2. Tap **Software update > Check new**.

## Restarting HTC Rezound with Beats Audio

If HTC Rezound with Beats Audio is running slower than normal, an application is not performing properly, or HTC Rezound with Beats Audio becomes unresponsive, try restarting HTC Rezound with Beats Audio and see if that helps solve the problem.

1. If the display is off, press the POWER/LOCK button to turn it back on.
2. Unlock the display.
3. Press and hold the POWER/LOCK button, and then tap **Restart**.
4. When asked to confirm, tap **Restart**.



If these steps don't work, you can remove and replace the battery, and then turn HTC Rezound with Beats Audio on to restart it.

## Resetting HTC Rezound with Beats Audio

Do a factory reset to return HTC Rezound with Beats Audio to its original state before the first time you turned it on.

If you're passing HTC Rezound with Beats Audio on to someone else or HTC Rezound with Beats Audio has a persistent problem that cannot be solved, you can perform a factory reset (also called a hard reset). Factory reset is not a step to be taken lightly. It'll permanently delete all your data and customized settings, and will remove any applications you've downloaded and installed. Be sure to back up any data and files you want to keep before you do a factory reset.

---

### Performing a factory reset via settings

---

The most convenient way to do a factory reset is via the settings.

1. From the Home screen, press MENU , and then tap **Settings**.
2. Tap **SD & phone storage > Factory data reset**.
3. Tap **Reset phone**, and then tap **Erase everything**.

---

## Performing a factory reset using hardware buttons

---

If you can't turn HTC Rezound with Beats Audio on or access settings, you can still perform a factory reset by using the hardware buttons on HTC Rezound with Beats Audio.

1. Remove the battery, wait for a few seconds, then reinsert the battery.
2. Press and hold the VOLUME DOWN button, and then briefly press the POWER/LOCK button.
3. Wait for the screen with the three Android images to appear, and then release the VOLUME DOWN button.
4. Press VOLUME DOWN to select **FACTORY RESET**, and then press the POWER/LOCK button.

# Trademarks and copyrights

©2011 HTC Corporation. All Rights Reserved.

HTC, the HTC logo, the HTC quietly brilliant logo, HTC Rezound, Friend Stream, HTC Footprints, HTC Sense, HTC Sync, and HTC Watch are trademarks or service marks of HTC Corporation.

Google, the Google logo, Android, the Android logo, Android Market, the Android Market logo, Google Apps, Google Calendar, Google Checkout, Google Earth, Google Latitude, Google Maps, Google Talk, Gmail, Picasa, and YouTube are trademarks of Google Inc.

Microsoft, Windows, ActiveSync, Excel, Outlook, PowerPoint, Windows Media, and Windows Vista are either registered trademarks or trademarks of Microsoft Corporation in the United States and/or other countries.

The *Bluetooth*® word mark and logos are registered trademarks by Bluetooth SIG, Inc.

This device contains Adobe® Flash® Player and Adobe® Reader® Mobile software under license from Adobe Systems Incorporated. Copyright ©1995–2011 Adobe Systems Incorporated. All rights reserved. Adobe and Reader are trademarks of Adobe Systems Incorporated.

Wi-Fi® is a registered trademark of the Wireless Fidelity Alliance, Inc.

microSD is a trademark of SD-3C LLC.

Facebook is a trademark of Facebook, Inc.

Twitter is a trademark of Twitter, Inc., and is used under license.

FLICKR and the FLICKR Dots logo are the trademarks and/or registered trademarks of Yahoo! Inc.

DLNA, DLNA Certified, and the DLNA disc logo are trademarks or registered trademarks of Digital Living Network Alliance. All rights reserved. Unauthorized use is strictly prohibited.

iTunes is a registered trademark of Apple Inc., registered in the U.S. and other countries.

Polaris Office is a trademark of Infraware, Inc.

Beats, BeatsAudio, and the b logo are trademarks of Beats Electronics, LLC.

All other company, product and service names mentioned herein are trademarks, registered trademarks or service marks of their respective owners.

Screen images contained herein are simulated. HTC shall not be liable for technical or editorial errors or omissions contained herein, nor for incidental or consequential damages resulting from furnishing this material. The information is provided “as is” without warranty of any kind and is subject to change without notice. HTC also reserves the right to revise the content of this document at any time without prior notice.

No part of this document may be reproduced or transmitted in any form or by any means, electronic or mechanical, including photocopying, recording or storing in a retrieval system, or translated into any language in any form without prior written permission of HTC.

# Index

## A

- Airplane mode *85*
- Alarm *249*
- Android Market *243*
- Apps
  - deleting *245*
  - installing *243, 283*

## B

- Back up contacts *174*
- Battery
  - installing *25*
  - optimizing battery life *330*
- Bluetooth
  - connecting a Bluetooth headset or car kit *308*
  - disconnecting or unpairing *310*
  - sending information *311*
  - sharing music *147*
  - turning on or off *307*
- Browser
  - bookmarks *112*
  - navigating and zooming *108*
  - opening a new window *109*
  - options *114*
  - using *107*

## C

- Calendar
  - creating an event *222*
  - managing events *225*
  - reminders *228*
  - settings *229*
  - views *223*
  - widget *230*
- Call history *82*
- Camera
  - effects *121*
  - scenes *122*
  - taking a photo *118*
  - using the front camera *118*
  - zooming *117*
- Change phone language *330*
- Clock *246*
- Contacts
  - adding *169*
  - copying from SIM card *169*
  - deleting *176*
- Copying text *50*

## D

- Data connection
  - turning on or off *297*
- Delete apps *245*
- Delete contacts *176*
- Display
  - adjusting screen brightness *325*

- changing the time before the screen turns off *326*
- recalibrating G-sensor *327*
- turning off screen rotation *326*

DLNA *148*

Downloading

- from Web *110*
- viewing downloads *111*

## E

Email *205*

Exchange ActiveSync

- Out of office *218*
- sending a meeting request *219*
- working with Exchange ActiveSync email *218*

## F

Facebook

- sharing your location *192*

Facebook chat *187, 200*

Facebook for HTC Sense *185*

Factory reset *339*

Firmware *337*

Flight mode *85*

Footprints *232*

Friend Stream *188*

## G

Gallery

- about *127*
- editing photos *131*
- sending photos and videos *134*

- sharing photos and videos *136*

- viewing photos *128*

- viewing photos in social networks *139*

- watching video *130*

Getting started *15*

Gmail *202*

Google Account *159*

Google Maps *234*

## H

Hands free *308*

Hard reset *339*

Headphones *308*

Home screen

- about *32*
- adding widgets *57*
- rearranging items *61*
- rearranging the home panels *62*

HTC Clock

- Desk Clock *247*
- setting an alarm *249*
- World Clock *247*

HTC Watch *151*

## I

Internet calling *80*

Internet connection

- Internet pass-through *305*
- Tethering *304*
- VPN *302*
- Wi-Fi *298*
- wireless router *306*

Internet pass-through *305*



---

## K

---

### Keyboard

- copying and pasting text *294*
  - dictionary *290*
  - editing text *294*
  - entering text *287*
  - entering text by speaking *292*
  - predictive text *289*
  - selecting text *294*
- 

## L

---

Language *330*

Leap view *33*

### Locations

- footprints *232*
- 

## M

---

### Mail

- adding a POP3/IMAP account *205*
- adding an Exchange account *206*
- deleting an email account *220*
- managing email messages *211*
- sending *212*
- sorting email messages *210*
- unified inbox *208*
- working with Exchange ActiveSync email *218*

Making a call *69*

Managing memory *332*

Market *243*

Master reset *339*

Meeting request *219*

---

### Messages

- deleting *99*
- deleting a conversation *100*
- forwarding *96*
- protecting from deletion *99*
- viewing *94*

microSD card *22*

MMS *90*

### Modem

- USB tethering *304*
- using your computer *305*

Multimedia message *90*

### Music

- browsing the library *140*
  - listening *141*
  - playing music from Lock screen *142*
  - playlist *143*
  - setting a song as ringtone *145*
  - sharing music using Bluetooth *147*
  - widget *143*
- 

## N

---

### News

- reading stories *255*
- subscribing to channels *254*

### Notifications

- panel *44*
- 

## O

---

### Online accounts

- about *158*
- managing *161*

### Onscreen keyboard

- copying and pasting text *294*
- dictionary *290*

- editing text *294*
- entering text *287*
- entering text by speaking *292*
- predictive text *289*
- selecting text *294*
- settings *295*

Optimizing battery life *330*

---

## P

---

Pair a Bluetooth device *308*

People

- adding a new contact *169*
- deleting contacts *176*
- editing a contact *176*
- filtering your contacts *167*
- groups *178*
- merging contact information *172*
- searching for a contact *170*
- widget *182*

Phone calls

- calling a number in a message *71*
- calling a number in an email *72*
- calling using Wi-Fi *80*
- making an emergency call *72*
- receiving *73*

Phone information *335*

Phone settings

- About phone *335*
- Applications *332*
- Display *325*
- Language & keyboard *330*
- Power *330*
- SD & phone storage *332*
- Sound *328*

Phone updates *337*

Photos

- editing *131*
- sharing *136*
- viewing *128*

Playing music from the Lock screen *142*

PUK (PIN Unblock Key) *316*

---

## Q

---

Quick Settings *45*

---

## R

---

Record your voice *272*

Ring volume

- lowering ring volume  
automatically *328*
- making your phone ring louder *329*

Ringtone

- setting *145*
- trimming *145*

Router *306*

RSS *254*

---

## S

---

Scan

- bar code *267*
- history *269*
- scanning a code *268*

Scenes *53*

Screen

- adjusting screen brightness *325*
- changing the time before the screen  
turns off *326*

- recalibrating G-sensor 327
- turning off screen rotation 326

SD card 22

Search 105, 106

Security

- changing your screen lock 318
- locking with a screen lock pattern, PIN, or password 317
- locking your SIM card with a PIN 316

Settings

- About phone 335
- Applications 332
- Language & keyboard 330
- Power 330
- SD & phone storage 332
- Sound 328

Sharing

- games and apps 259

SIM card

- SIM PIN 316

Slideshow 129

Smart dial 70

SMS 89

Social networks

- adding 160
- viewing photos 139

Software update 337

Sound

- audible selection 328
- changing ringtone, notifications, and alarms 65
- lowering ring volume automatically 328
- Pocket mode 329
- switching profiles 328
- switching to speakerphone 329

Sound set 64

Speakerphone 77

Speed dial 70

Storage card

- moving apps to the storage card 334

Sync

- online accounts 161

---

## T

---

Tasks

- creating a list 263
- creating a task 264
- filtering tasks 263
- managing lists 264
- signing on to Exchange account 262
- to do 264

Tethering 304

Text message 89

---

## U

---

Updating phone software 337

Upgrade 337

USB 304

---

## V

---

Videos

- sharing 136
- trimming 133
- watching 130

Voice input 292

Voice Recorder 272

VPN

- adding a connection 303
- connecting 303

## W

---

### Wallpaper

- changing *55*

### Weather

- adding cities *252*
- checking weather *251*

### Web browser *107*

### Wi-Fi

- calling *80*
- connecting to another network *301*
- network status *301*
- turning on *298*

### Widgets

- adding *57*
- changing settings *58*
- removing *62*

### Wireless router *306*

---

## Y

---

### YouTube

- sharing videos *138*