

C77EN1291

E

ENGLISH

SIGMA
DP1
Merrill

THE SIGMA DP1
A COMPACT CAMERA WITH
MERRILL GENERATION
FOVEON X3 FULL COLOR
IMAGE SENSOR

USER'S MANUAL

Thank you for purchasing the Sigma DP1 Merrill Digital Compact Camera

You will get the greatest performance and enjoyment from your new DP1 Merrill camera's features by reading this instruction manual carefully before operating it. Enjoy your new Sigma camera!

- Please keep this instruction booklet handy for future reference. Doing so will allow you to understand and take advantage of the camera's unique features at any time.
- The warranty of this product is one year from the date of purchase. Warranty terms and warranty card are on a separate sheet, attached. Please refer to these materials for details.

NOTES ON COPYRIGHT

This camera is intended only for personal use and should never be used in a way that infringes upon or contravenes international or domestic copyright laws and regulations. In addition, although it is intended purely for personal use, some restrictions may be applied to the photographing of demonstrations, performances, shows, exhibitions, or commercial properties, etc. Copyright or other legal rights should not be contravened.

- FOVEON is a registered trademark of Foveon, Inc. X3, and the X3 Logos are trademarks of Foveon, Inc.
- IBM PC/AT series computer is a trademark or registered trademark of International Business Machines Corporation (IBM) in the U.S.A.
- Microsoft and Windows are either registered trademarks or trademarks of Microsoft Corporation in the United States and/or other countries.
- Macintosh and MAC OS are registered trademarks or trademarks of Apple Inc. in the U.S.A. and /or other countries.
- Adobe and Photoshop are trademarks of Adobe Systems Incorporated.
- All other company or product names used in documents are trademarks or registered trademarks of their respective holders.
- Element font designed by Ricoh CO., Ltd. is used for the display of the menu window of this camera.



Disposal of Electric and Electronic Equipment in Private Households
Disposal of used Electrical & Electronic Equipment (Applicable in the European Union and other European countries with separate collection systems)

This symbol indicates that this product shall not be treated as household waste. Instead it shall be collected separately for the recycling of electrical and electronic equipment. If the new products are purchased, this product might be handed over to the distributor or the collection system of waste electrical and electronic equipment eventually. By ensuring this product is disposed of correctly, you will help prevent potential negative consequences for the environment and human health, which could otherwise be caused by inappropriate waste handling of this product or components of this product. If this product is disposed illegally, it might cause a possibility of penalties. For more detailed information about recycling of this product, please contact your local city office, your household waste disposal service or the shop where you have purchased the product.

PACKAGE CONTENTS / ACCESSORIES

Please make sure that following standard accessories are included with your camera. If any of them is missing, contact the retailer from which you purchased your camera immediately.

1. Camera Body (DP1 Merrill)
2. Lens Cap (on the camera)
3. Hot Shoe Cover (on the camera)
4. Strap
5. Li-ion Battery BP-41 (2 pieces)
6. Battery Charger BC-41
7. Battery Charger Cable
(It is included only when the type of Battery charger is "Inlet" type.)
8. USB Cable
9. Audio Video Cable
10. Instruction Manual
11. Limited Warranty
12. Warranty Sticker

- No memory card is included with this camera. Please purchase this separately.

TABLE OF CONTENTS

PACKAGE CONTENTS / ACCESSORIES.....	2
TABLE OF CONTENTS	3
SAFETY PRECAUTIONS	6
HANDLING PRECAUTIONS.....	9
DESCRIPTION OF THE PARTS	11
COLOR LCD MONITOR INDICATION	13
BASIC OPERATION AND QUICK REFERENCE.....	14
PREPARATION	17
ATTACHING THE CARRY STRAP	17
LENS CAP	17
LOADING THE BATTERY.....	18
CHECKING THE BATTERY STATUS	22
USING A HOME POWER SUPPLY (SOLD SEPARATELY).....	23
SETTING THE LANGUAGE	25
SETTING THE TIME AND DATE	27
CAMERA SET-UP MENU	28
QUICK SET MENU	35
CHANGING THE COLOR LCD MONITOR DISPLAY	38
INSERTING AND REMOVING THE CARD.....	40
FORMATTING THE CARD	42
SHUTTER BUTTON	43
BASIC OPERATION	44
SELECTING THE EXPOSURE MODE	44
SELECTING THE EXPOSURE MODE	44
P PROGRAM AE.....	45
A APERTURE PRIORITY AE	46
S SHUTTER SPEED PRIORITY AE	47
M MANUAL EXPOSURE	48
FOCUSING	49
FOCUS MODE.....	49
HOW TO USE AUTOFOCUS.....	49
SETTING THE FOCUS FRAME	50
FOCUS LOCK.....	51
AF+MF MODE	51

AF LIMIT MODE.....	52
SPEED PRIORITY AF.....	53
MANUAL FOCUS.....	53
OPERATION OF THE DRIVE MODE	55
SINGLE FRAME SHOOTING	55
CONTINUOUS SHOOTING.....	56
SELF TIMER.....	57
INTERVAL TIMER.....	57
UNLIMITED SHOOTING.....	59
ADVANCED OPERATION	60
SETTING THE WHITE BALANCE (WB)	60
SETTING THE SENSITIVITY (ISO EQUIVALENCY)	62
IMAGE FILE SETTING	65
COLOR SPACE	66
PICTURE SETTINGS	67
SELECTING THE METERING MODE	68
AE LOCK	69
EXPOSURE COMPENSATION	71
AUTO BRACKETING.....	71
COLOR MODE	74
AUTO ROTATE.....	75
CUSTOM MODE.....	76
USING THE EXTERNAL FLASH	78
THE EXTERNAL FLASH.....	78
USING THE EXTERNAL FLASH	78
SETTING THE FLASH MODE	79
FLASH EXPOSURE COMPENSATION.....	81
REVIEWING AND DELETING IMAGES	82
QUICK PREVIEW	82
CHANGING THE QUICK PREVIEW DURATION	82
REVIEWING IMAGES	83
VIEWING ONE IMAGE AT A TIME.....	84
MAGNIFYING IMAGES (ZOOMED-IN VIEW).....	85
VIEWING NINE IMAGES AT A TIME (CONTACT SHEET VIEW)	86

VIEWING IMAGE INFORMATION	87
MAGNIFIED IMAGES IN IMAGE INFO SCREEN	88
HISTOGRAM	89
VIEWING IMAGES ON A TV	90
DELETING FILES	91
DELETE A FILE WITH THE DELETE BUTTON	91
DELETE FILES FROM THE DELETE MENU	92
OTHER REVIEWING FEATURES	93
LOCKING FILES	93
MARKING IMAGES	96
ROTATING IMAGES	98
EXPOSURE WARNING	99
OK BUTTON SHORTCUT	100
RECORDING SOUND MEMO	101
SHOWING A SLIDESHOW	103
DPOF (DIGITAL PRINT ORDER FORMAT)	105
RECORDING AND PLAYING BACK MOVIES	106
RECORDING MOVIES	106
PLAYING BACK MOVIES	108
CHANGING OTHER SETTINGS	110
FILE NUMBERING SYSTEM	110
CUSTOMIZING THE DIAL AND BUTTON	112
LCD OFF AND AUTO POWER OFF	114
SOUND SETTINGS	115
RESET TO THE DEFAULTS	116
CONNECTING TO A COMPUTER	117
CONNECTING YOUR CAMERA TO A COMPUTER	117
REFERENCE	118
OPTIONAL ACCESSORIES	118
MAINTENANCE	119
EXPLANATION OF TERMS	120
TROUBLESHOOTING	122
SPECIFICATIONS	125

SAFETY PRECAUTIONS

To avoid causing damage or injury, please read this instruction manual carefully, before using the camera.

Please take special note of the following two cautionary symbols.

 **Warning !!** Using the product and disregarding this warning sign may cause serious injury or other dangerous results.

 **Caution !!** Using the product disregarding this caution sign may cause injury or damage.

 This symbol denotes a warning or point, where caution is required.

 This Symbol contains information regarding the actions that must be avoided.

WARNING (BATTERY, BATTERY CHARGER AND AC ADAPTER)

 Keep batteries in a safe place out of children's reach. If a battery is swallowed, call for emergency medical aid immediately.

 Do not use any battery other than the designated battery types. Doing so may cause battery explosion, battery leakage, camera damage, injury or fire.

 Do not use any battery other than that specified in this booklet. Otherwise, it might cause battery explosion, battery leakage, camera damage, injury or fire.

 Avoid any shock, shake and drop. Ignoring this warning may cause battery explosion, or battery leakage, resulting in injury or fire.

 Never disassemble, short circuit, heat, or put batteries into fire. Ignoring this warning may cause battery explosion, battery leakage, injury or fire.

 Please only use charger with the dedicated battery. Charging other battery types causes battery explosion, battery leakage, camera damage, injury or fire.







 If for some reason, the camera or batteries emit smoke, or if overheating or the smell of burning is detected, remove the batteries, taking care to avoid being burned. Take the camera to the retailer where you bought it, or to an authorized Sigma service station.

 Please follow all guidelines, rules and regulations of your community regarding the disposal of batteries.









 If you do not use the camera for a long period of time, remove the battery.

 Do not use any AC adapter other than the one provided with your camera. Using other brands may cause electrical shock and fire



SAFETY PRECAUTIONS

-  The AC Adapter is designed for use with this product only. Do not use it with any other appliance. Doing so may cause overheating, fire, electric shock or injury.
-  If the adapter is emitting smoke, generating a strange odor or making an abnormal noise, while in use, disconnect the power plug from the outlet immediately. Otherwise, fire or electric shock may result.
-  If water or a foreign object gets into the adapter, unplug from the AC outlet immediately. It could cause fire or electric shock.
-  Do not attempt to modify or disassemble this product. Doing so can cause fire or electric shock.
-  Do not place any heavy objects on the power cord, or pull it, bend it unduly, or heat it. It could damage the cord, and could cause fire or electric shock.
-  Do not use this product with AC voltage other than the specified power supply voltage (AC100V - 240V). Doing so could cause fire or electric shock.
-  Use a safety approved AC power cord as is specified by each country.





WARNING (CAMERA)

-  Never use your camera in an environment where flammable or burnable, gas, liquids or chemicals, such as Propane, Gasoline, etc., are present.
-  Keep the camera in a safe place that children cannot reach. Playing with the camera strap around one's neck can cause strangulation.
-  Do not disassemble the camera; Doing so can cause electric shocks and burns.
-  Do not touch internal parts of the camera that become exposed as a result of damage, it could cause fire or electric shock. Remove the batteries and contact an authorized Sigma service station.
-  Keep the camera away from moisture or water. If you drop your camera/lens in water, please contact the retailer where you purchased the camera, or a service station immediately. If you use the camera with this condition it can cause electric shock or fire.
-  Prevent water, or metallic and other conductive objects from coming into contact with the terminals of the camera body. This can result in electric shock, overheating and fire.
-  Do not fire the flash close to eyes, otherwise the bright light could damage the eye. Keep at least 1m/3feet distance between the face and the camera when taking a picture with flash.
-  Do not cover the flash with your finger or hand, it can cause skin burn.

CAUTION (BATTERY CHARGER AND AC ADAPTER)

-  Do not pull the Battery Charger or the AC power cord, when disconnecting the AC adapter from the AC outlet. It could cause fire or electric shock due to damaged cord. Always take hold of the molded AC plug, when unplugging it from the outlet.
-  Do not cover the Battery Charger or the AC adapter with cloth, cushions, etc. It could cause excessive heat, deform the case, and cause fire.
-  When Battery Charger is not used unplug it from the outlet.

CAUTION (CAMERA)

-  Do not leave the camera without the lens cap in place. Light entering through the lens for long periods of time could cause damage to the camera.
-  Please do not carry your camera while a tripod is attached, as this could result in injury or a fall.
-  Please do not grasp the camera with wet hand, as it might cause electric shock
-  Do not leave the camera in a hot place or in a car parked in the sun. If the camera becomes hot, it might cause burns to the skin.
-  If the liquid crystal display (LCD) monitor becomes damaged, be careful of the fragments of glass, which can cause injury. If the liquid inside the LCD monitor leaks out, and you are faced with the following situations, please do as follows.
 - If the liquid adheres to clothes or the skin, wash it away with soap immediately.
 - If the liquid enters the eye, flush the affected eye with clean water immediately for 15 minutes, and seek medical assistance.
 - If the liquid is swallowed, drink a large quantity of water, induce vomiting and seek medical assistance.

HANDLING PRECAUTIONS

Please read this section before using the camera.

Study and familiarize yourself with the functions of your camera before using it. No compensation or guarantee is provided for unsatisfactory pictures or loss of profit, etc.

Carry spare batteries when you use the camera in a cold environment, on a field trip, or when taking many pictures at one time.

ENVIRONMENT

- Your camera is a precision instrument. Do not drop it or subject it to physical shock.
- This camera is not waterproof, and cannot be used underwater. Wipe off any water droplets with a dry cloth as soon as possible. If the camera gets really wet, promptly consult your nearest Sigma Service Center.
- Do not leave the camera in a dusty, hot, or highly humid environment for a long period of time.
- If the camera is moved from a cold place to a warm room, water droplets may appear on the camera. Please keep the camera in a bag until it is acclimatized to the ambient room temperature.
- The camera will work within a temperature range between 0°C/32°F and +40°C/104°F and humidity less than 85% (no condensation). However, in cold temperatures below 0°C, the power performance of the battery is reduced. Please carry a spare battery in these circumstances, and keep the batteries warm.
- Static electricity or magnetic fields may affect the operation of the camera. If such exposure occurs, please remove the battery from the camera and re-insert it, to reset the camera's microprocessors.

DURING PROLONGED USE

- Although there are cases where the surface of camera gets hot, this is not a malfunction.
- If you use the camera for an extended period of time, the camera may get hot and the warning mark (🔥) will be displayed. If the camera gets too heat, a warning message will be displayed and the camera will turn off automatically.

- If the camera turns off, please leave it switched off for more than ten minutes to lower its temperature.
- Image quality may lower when the camera gets hot. If the warning mark (🔥) is displayed, we recommend turning off the camera and wait until the temperature of the camera becomes lower.

SD MEMORY CARD AND MULTIMEDIA CARD (SOLD SEPARATELY)

The DP1 Merrill camera uses a SD memory card, SDHC memory card, SDXC memory card and multimedia card.

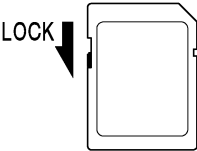



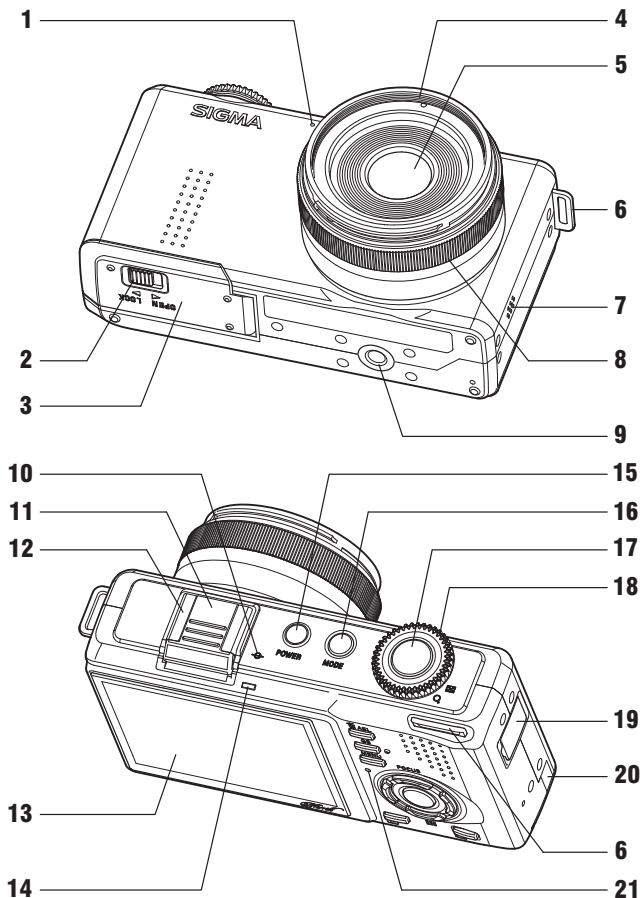

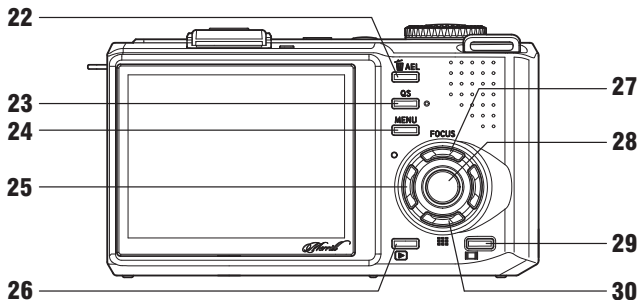
- In this instruction manual, SD memory card, SDHC memory card, SDXC memory card and Multimedia card are referred to as the 'Card'.
 - We recommend using the SDHC memory card or SDXC memory card to store images.
 - SD memory card, SDHC memory card or SDXC memory card incorporate the write protection switch, which prevents writing or formatting the card accidentally. If the switch is placed in the 'LOCK' position, it is not possible to overwrite or erase your data accidentally.
- 
- The diagram shows a rectangular memory card with a notch on the right side. On the left edge, there is a small rectangular switch. A black arrow points downwards from the word 'LOCK' to this switch, indicating its position when the card is locked.
- We do not recommend using a multimedia card in continuous shooting or Movie mode due to the slow writing speed.
 - Do not leave the card in direct sunlight or near a heating device.
 - Avoid storing cards in environments of high temperature and humidity or where static electricity or electromagnetic fields may be generated
 - For proper usage of the card, please refer to their instruction manuals.
 - The "Delete" feature of the Camera and PC may not delete the data in the memory card completely. Some data might still remain. If you wish to remove all data from card securely, please use third party software.

DESCRIPTION OF THE PARTS





1.	MICROPHONE
2.	RELEASE LEVER
3.	BATTERY / CARD COVER
4.	FILTER ATTACHMENT THREAD
5.	LENS
6.	CAMERA STRAP EYELET
7.	SPEAKER
8.	FOCUS RING
9.	TRIPOD SOCKET
10.	FOCAL PLANE MARK
11.	HOT SHOE COVER
12.	HOT SHOE
13.	COLOR LCD MONITOR
14.	AUTO FOCUS LAMP
15.	POWER SWITCH
16.	MODE BUTTON
17.	SHUTTER BUTTON
18.	COMMAND DIAL
19.	USB / AV COVER
20.	DC CONNECTOR COVER

21.	BUSY LAMP
22.	 AEL /  (AE LOCK / DELETE) BUTTON
23.	QS (QUICK SET) BUTTON
24.	MENU (MENU) BUTTON
25.	 4-WAY CONTROLLER
26.	 (VIEW) BUTTON
27.	FOCUS (FOCUS MODE) BUTTON
28.	 (OK) BUTTON
29.	 (DISPLAY) BUTTON
30.	 (FOCUSING POINT) BUTTON

COLOR LCD MONITOR INDICATION

Explanation of the icons displayed in still image shooting.

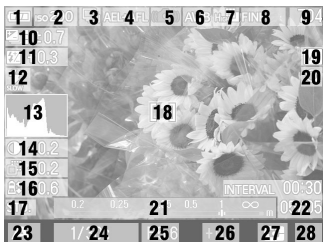
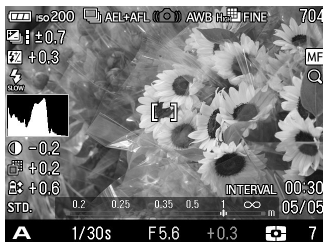

1	Battery Level Indicator
2	ISO Sensitivity
3	Drive Mode
4	AE Lock *
5	Camera Shake Warning
6	White Balance
7	Image Size
8	Image Quality
9	Number of shots remaining
10	Auto Bracket *
11	Flash Exposure Compensation value *
12	Flash Mode *
13	Histogram *
14	Contrast *

15	Sharpness *
16	Saturation *
17	Color Mode
18	Focusing Frame
19	Focus Mode *
20	MF Enlarged Display *
21	MF Scale Bar *
22	Interval timer *
23	Exposure Mode
24	Shutter Speed
25	F Number
26	Exposure Compensation Value / Exposure Meter
27	Metering Mode
28	Number of shots remaining before memory buffer full

* Displayed only during setting.



This mark shows that the image is being processed in camera after shooting. While this mark is displayed, it is not possible to operate the camera.



This mark shows that the camera is still shooting with a slow shutter speed.

BASIC OPERATION AND QUICK REFERENCE

The DP1 Merrill camera has many advanced features. This section, describes basic camera operation. You can find more details in later sections.

PREPARATION

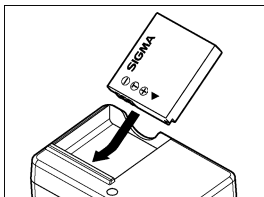

Charging the battery (P.18)

Charge the supplied lithium-ion battery with the provided battery charger.

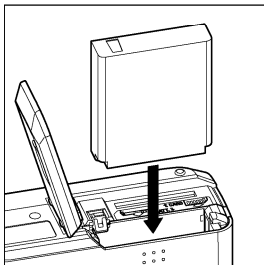

To insert the battery (P.20)

Insert the battery into the chamber in accordance with the diagram.

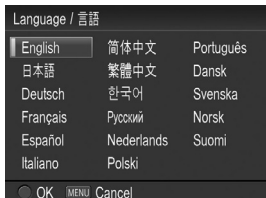

Set the language (P.25)

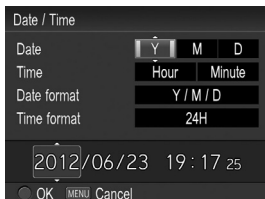

Set the date and time (P.27)

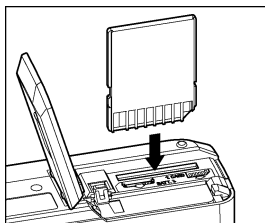

Loading the card (P.40)

TAKING THE PICTURE

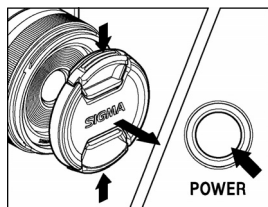

Turn the camera body on.

Remove the lens cap and press the Power switch.

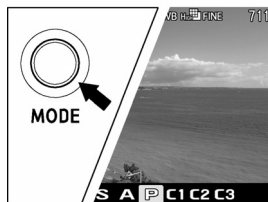

Select the exposure mode (P.44)

Put the 'Mode' dial switch in **P** (Program AE) position



Focus (P.49)

Compose your image with the color LCD monitor and press the shutter button “half-way” to activate exposure metering and autofocus.

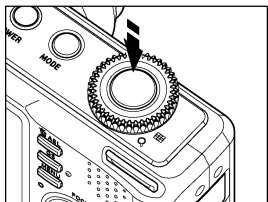
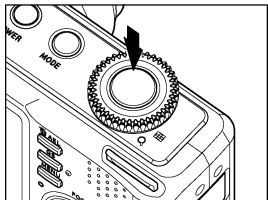

Take a picture

Fully press the shutter button to take the picture.



Review the image. (P.82)

The image is displayed for 2 seconds on the LCD monitor.

PREPARATION

This section describes necessary preparations before using the camera.

ATTACHING THE CARRY STRAP

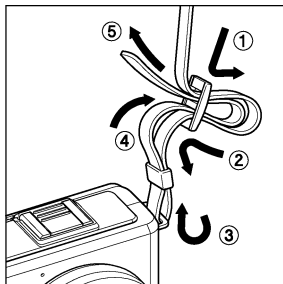

1

Undo the strap end.

2

Attach the carry strap as shown.

LENS CAP

To preserve the lens, the lens cap is attached. If you do not use the camera, please keep the lens cap attached.

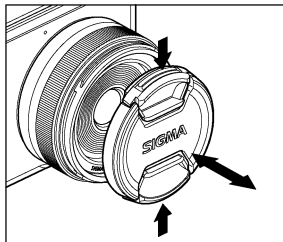

Attach or remove the lens cap as shown in the illustration.

LOADING THE BATTERY

A lithium-ion battery, BP-41, is provided with the DP1 Merrill camera. Charge the battery before using the camera for the first time. Charge the battery by the supplied battery charger, BC-41, when the battery is empty.

- Either the “Plug-in type” or “Inlet type” of Battery Charger is supplied depending on the region of your purchase.

TO CHARGE THE BATTERY

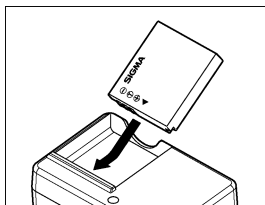

1

Attach the battery by sliding it in the direction of the arrow, as shown in the diagram.

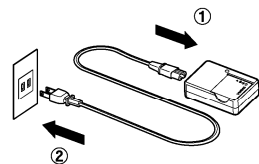

2

Plug-in type

Pull the plug down until it clicks, as shown in the diagram and then insert it into the wall outlet.

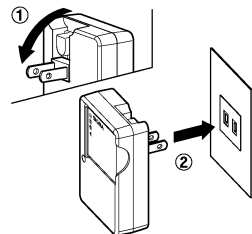

Inlet type

Connect the power cable to the charger and insert the plug into the wall outlet.

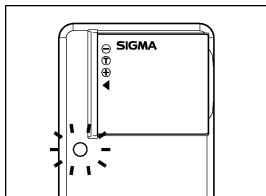

- The charge lamp will be green whilst the battery is charging
- It takes about 140 minutes to recharge the battery.
- Required time for recharging the battery depends on the ambient temperature and status of recharge level.

3

When the charge lamp goes out, charging is completed. Remove the battery from the charger and remove the charger from the wall outlet.

- We recommend charging the battery before using the camera again. If it is not used for several days, the battery performance decreases.
- If the number of possible images from one charge of the battery considerably decreases, it may indicate the end of battery's life. In this case, please purchase a new battery.

LOADING THE BATTERY

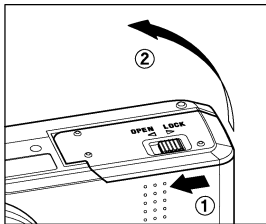

1

Slide the Release lever to the OPEN position, and open the Battery / Card Cover as shown in the illustration.

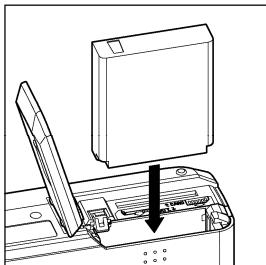

2

Insert the battery into the chamber in accordance with the diagram.

- Insert the battery until it locks into place.

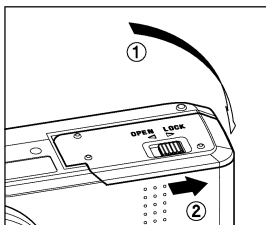

3

Close the Battery / Card Cover and Slide the Release lever to the LOCK position as shown in the illustration.

TO REMOVE THE BATTERY

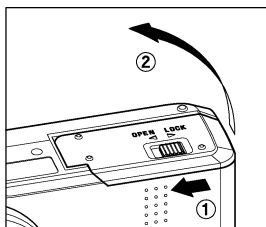

1

Slide the Release lever to the OPEN position, and open the Battery / Card Cover as shown in the illustration.

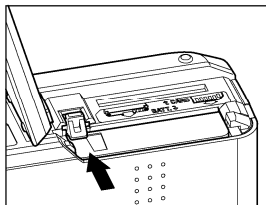

2

Eject the battery by sliding the battery compartment cover latch in the direction of the arrow, as shown in the illustration.

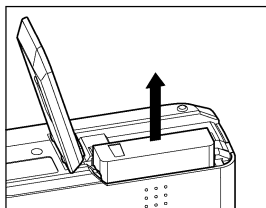





WARNING!!

- While the Busy Lamp is on, please do not open the Battery Cover or Card Cover. By doing so, the camera will turn off and result in data loss. This could also cause damage to the camera and/or memory card.

CHECKING THE BATTERY STATUS

The battery icon, which shows the capacity of the battery, is shown on the left corner on the color LCD panel. Explanations of the symbols are given as follows. Please take notice of the battery status before and when in use.

	Battery Status
 White	The battery strength is sufficient.
 White	The battery level is low and the battery will need to be changed soon.
 White	The power of the battery is insufficient, replace the battery immediately.
 Red	The power of the battery is empty; it is not possible to work. Please replace the battery.

USING A HOME POWER SUPPLY (Sold Separately)

You can power the camera from a wall outlet using the provided AC Adapter SAC-5 and DC Connector CN-11. When using your camera for an extended period of time, reviewing the pictures or connecting the camera to a computer, we recommend that you operate the camera from a household power outlet.

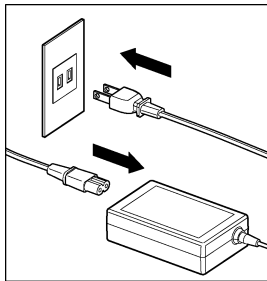

1

Connect the AC cable to the AC adapter.

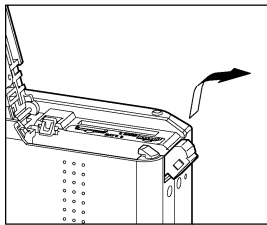

2

Open the Battery / Card Cover, and open the DC connector cover as shown in the illustration.

- Do not pull too hard on the DC connector cover as it may come away from camera body.

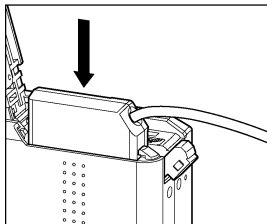

3

Insert the DC connector as shown in the illustration until it locks into place.

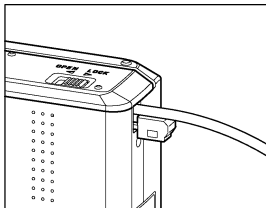

4

Close the Battery / Card Cover carefully so as not to pinch the DC connector code.

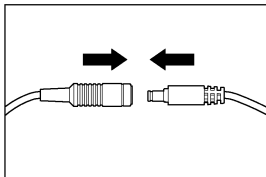

5

Connect the plug of the AC adapter and jack of the DC connector.

WARNING!!

- While the Busy Lamp is on, please do not open the Battery Cover or Card Cover. By doing so, the camera will turn off and result in data loss. This could also cause damage to the camera and/or memory card.

- When you have finished using the camera, please turn off the camera and disconnect the plug from the wall socket.
- When using the DP1 Merrill with an AC power supply, the battery icon shows the full symbol, regardless of the power level of the battery. If you start to operate the camera on battery power, the display will change and show the remaining power level of the battery.

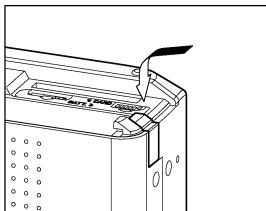

After taking the DC connector off from the camera body, close the DC connector cover as shown in the illustration.

SETTING THE LANGUAGE

You should receive the DP1 Merrill camera pre-set to English, however, if necessary, you can change the camera language yourself.

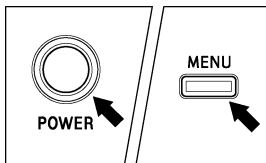

1
Turn the camera on.

2
Press the **MENU** button on the back of the camera to display the Camera Set-up Menu. (See P.28)



3
Select [**Camera Settings (3)**] by rotating the Command Dial.

4
Use the **◀▶** buttons to select [**Language/言語**].

5
Press the **OK** or **▶** button to open the language set-up page.

6
Use the **◀▶** buttons to select the desired language.

7
Press the **OK** button to apply the setting or the **MENU** button to return to the language set-up page without making any changes.

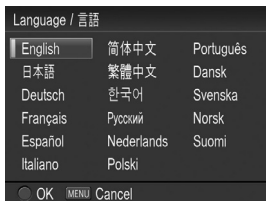

Selectable languages

English	English (Default)
日本語	Japanese
Deutsch	German
Français	French
Español	Spanish
Italiano	Italian
简体中文	Simplified Chinese
繁體中文	Traditional Chinese
한국어	Korean

Русский	Russian
Nederlands	Dutch
Polski	Polish
Português	Portuguese
Dansk	Danish
Svenska	Swedish
Norsk	Norwegian
Suomi	Finnish

SETTING THE TIME AND DATE

Please set the camera's internal clock, before using the camera for the first time or after extended periods of disuse.

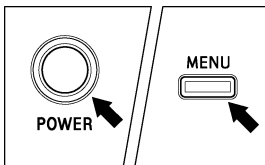

1
Turn the camera on.

2
Press the **MENU** button on the back of the camera to display the Camera Set-up Menu. (See P.28)

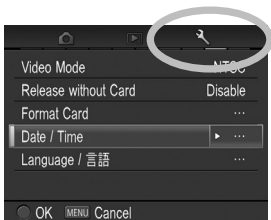

3
Select [**Camera Settings (3)**] by rotating the Command Dial.

4
Use the **◀▶** buttons to select [**Date/Time**].

5
Press the **OK** or **▶** button to open the date/time set-up page.

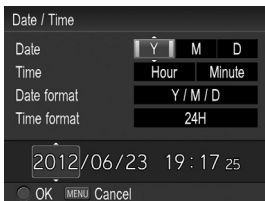

6
Press the **◀▶** button to select an item and change it by pressing the **◀▶** button.

7
Press the **OK** button to apply the setting or the **MENU** button to return to the date/time set-up page without making any changes.

TIP

- The date can be displayed in one of three formats: M/D/Y (month/day/year), D/M/Y (day/month/year), or Y/M/D (year/month/day). Select the desired format from "**Date Format**".
- The camera's internal clock is powered by a capacitor that receives its charge from camera's battery. If the camera is without battery for an extended period of time, such as after prolonged storage, the internal clock will need to be reset.

CAMERA SET-UP MENU

This section describes the various settings in the Camera Set-up menu. It is possible to set the camera functions from the Camera Set-up menu display.

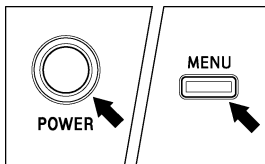

TO DISPLAY THE SET-UP MENU

Press the **MENU** button on the back of the camera.

- Press the **MENU** button again to close the Set-up Menu and the camera will be shooting mode. (If you reviewed images (P.83), it will return to the last previewed image.)

Tab area

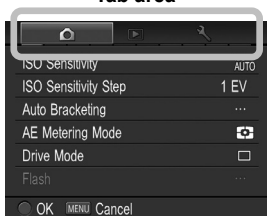

Move to any other tab

Each time the Command Dial is rotated, it will move to the next tab. (When the icon in the tab area is selected, it is possible to change the setting menu by pressing the ◀▶ buttons as well.)

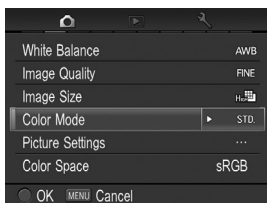

While in the Set-up Menu:

- Use the ◀▶ buttons to select menu items.
- Press the **OK** or ▶ button to open sub-menus or dialogs.

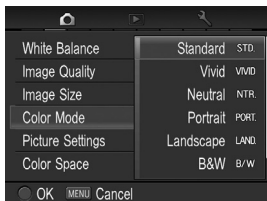

While in set-up sub-menus:

- Use the ◀▶ buttons to select setting options.
- Press the **OK** or ▶ button to apply new settings.
- Press the ◀ button to close sub-menus without applying changes.

- The Camera Set-up menu is divided into three groups.



Capture Settings

(Blue Tab)

This menu relates to shooting settings.

When an exposure mode is selected and the **MENU** button is pressed [ **Capture Settings**] will be displayed.

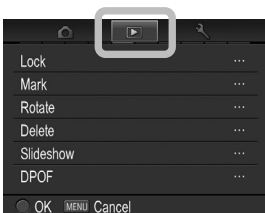

Playback Menu

(Red Tab)

This menu is for setting the playback related functions of the still images. The settings for printing, such as DPOF setting, is included in the Playback Settings menu.

If the **MENU** button is pressed during playback mode, [ **Playback Menu**] will be displayed.

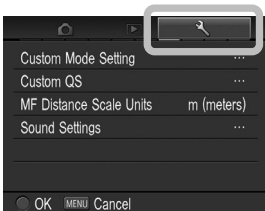

Camera Settings

(Yellow Tab)

This menu is used for camera setup such as date and language selection.

Open the Camera Set-up menu by pressing the **MENU** button and move to the [ **Camera Settings**] menu by rotating the Command Dial.

TIP

- Depending on the settings of the camera, some menu items and setting options cannot be selected. They will be displayed with a gray color.

LIST OF MENU FUNCTIONS

For more detailed information about each function, please refer to the individual pages.

Capture Settings

	Menu Item	Description	Page
 (1)	ISO Sensitivity	The higher value indicates a higher sensitivity. (The Image may have more “noise” with higher sensitivities.)	62
	ISO Sensitivity Step	Sets the ISO Sensitivity in steps of 1EV or 1/3EV.	64
	Auto Bracketing	Sets the steps and order of Auto Bracketing.	71
	AE Metering Mode	Selects the Metering Mode depending on the shooting conditions.	68
	Drive Mode	Selects the Drive Mode such as Self-Timer.	55
	Flash	Sets the mode of flash setting and Flash Exposure Compensation.	78

	Menu Item	Description	Page
 (2)	White Balance	Selects the White Balance Mode depending on the shooting conditions.	60
	Image Quality	Selects the quality of image to record.	66
	Image Size	Selects recording Image Size.	65
	Color Mode	Selects the desired Color mode depending on the shooting conditions.	74
	Picture Settings	Adjusts the Contrast, Saturation and Sharpness.	67
	Color space	Sets the color space to [sRGB] or [Adobe RGB].	66

Capture Settings

	Menu Item	Description	Page
 (3)	Auto Rotate	Sets or cancels to record the vertical image information.	75
	Quick Preview	Sets the duration of the Quick Preview image that is automatically displayed on the color LCD monitor after the image is captured.	82
	Grid Segment Display	Sets or cancels the Grid segment making it convenient for composition.	39
	Key arrangement	Sets the allocation of buttons or dials for exposure setting and exposure compensation in each shooting mode.	112
	Reverse Dial Direction Setting	Sets the direction of the Command Dial and Focus ring.	112

	Menu Item	Description	Page
 (4)	AEL Button Settings	Sets the function that the AEL button will perform.	69
	Half pressed AEL	Sets or cancels the exposure lock when the shutter button is pressed halfway.	70
	AF+MF	Select normal AF mode or AF+MF mode to allow manual focus override.	51
	AF Limit Mode	Set whether or not the AF Limit Mode is added to the Focus Mode button.	52
	Speed Priority AF	Sets the AF mode between Normal AF mode or Speed Priority AF mode.	53

▶ Playback Menu

	Menu Item	Description	Page
▶ (1)	Lock	Lock the image, or unlock the locked image.	93
	Mark	Mark the image, or unmark the marked image.	96
	Rotate	Rotate the image to the desired position for display.	98
	Delete	Delete the image.	92
	Slideshow	Start the slideshow (playback images automatically) or change the slideshow settings.	103
	DPOF	Select the images and set the quantity for printing.	105

	Menu Item	Description	Page
▶ (2)	Exposure Warning	Sets whether or not the over-exposure warning is shown on images.	99
	OK Shortcut	Sets the function that the OK button will perform during image review.	100
	Applied Rotate	Sets whether or not vertically orientated images are automatically rotated and displayed vertically.	—
	Sound Memo	Sets or cancels the Sound Memo, which can be recorded to a stored image.	101

Camera Settings

	Menu Item	Description	Page
 (1)	Custom Mode Setting	Register the setting of Custom Mode (C1 · C2 · C3).	76
	Custom QS	Selects which functions to allocate to the Quick Set menu.	37
	MF Scale Units	Sets the Manual Focus Scale Units when MF is used.	54
	Sound Settings	Sets the Shutter Sound, the Operation Sound, the Sound Volume and the Playback Volume for movie and Sound Memo.	115

	Menu Item	Description	Page
 (2)	File Numbering	Sets the file numbering system used when a new card is inserted in the camera.	110
	LCD Brightness	Sets the color LCD monitor brightness. (Images will not be affected by this change.)	—
	LCD Off	Sets the delay before the backlight of the color LCD monitor turns off automatically if no operation has occurred.	114
	Auto Power Off	Sets the delay before the camera shuts down automatically if no operation has occurred.	114

Camera Settings

	Menu Item	Description	Page
 (3)	Video Mode	Sets the standard to be used for video output when the camera is connected to a television or VCR.	90
	Release Without Card	Sets whether or not it is possible to release the shutter when the card is not inserted into the camera.	43
	Format Card	Formats the card. (Formatting will erase all data on the card.)	42
	Date/Time	Sets the date and time in the camera's internal clock and the format in which the date and time will be displayed.	27
	Language/言語	Sets the language in which menus and messages will be displayed.	25

	Menu Item	Description	Page
 (4)	Firmware Update	Confirm current firmware version and update the latest firmware version from card.	—
	Camera Reset	Restores all menu options to their default settings.	116

QUICK SET MENU

By pressing the **QS** button, it is possible to quickly access and change the settings of the following most commonly used camera functions.

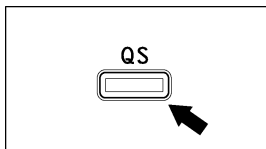

When the camera is in the Still Image Mode, the Quick Set Menu will be displayed by pressing the **QS** button. (By pressing the **QS** button again, it is possible to switch to **Qs1** or **Qs2**.)

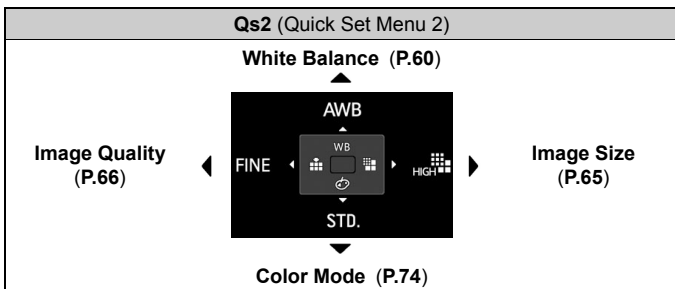
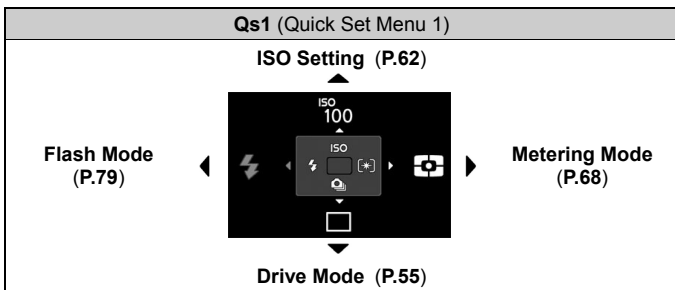

For example, if you wish to change the ISO Setting to 400



1

Press the **QS** button to display **Qs1**.

2

Press the **▲** button to select the ISO setting.

3

Press the **▲** button a few times, or rotate Command Dial to change the ISO setting to 400.

4

By pressing **OK** or the shutter button halfway, the settings will be applied and the camera will return to shooting mode.

CAUTION !!

- The Flash Mode cannot be set while the camera does not attach to the flashgun, or the flashgun is turned off.
- It is possible to select the Color Mode to **B&W** or **Sepia**, only when the Image Quality is set to **JPEG (FINE, NORM., BASIC)**.
- When the Color Mode is set to **B&W** or **Sepia** and Image Quality is changed to **RAW** or **RAW+JPG**, the Color Mode will be automatically changed to **STD**.(Standard).
- When you select **☑** (Custom) from [**White Balance**], the current stored setting in [**Camera Capture Settings**] (P.28) → [**White Balance**] → [**Custom ☑**] will be used.
- It is not possible to capture a new custom white balance from **☑** (Custom) in Quick Set Menu. Please capture a new custom white balance by referring “SETTING A CUSTOM WHITE BALANCE” in **P.61**.

The functions allocated to the Quick Set menu can be changed.

Available functions to be allocated to the Quick Set menu

ISO Sensitivity (P.62)	Image Size (P.65)
Bracketing Amount (P.71)	Color Mode (P.74)
AE Metering Mode (P.68)	Contrast (P.67)
Drive Mode (P.55)	Sharpness (P.67)
Flash Mode (P.79)	Saturation (P.67)
White Balance (P.60)	Exposure Mode (P.44)
Image Quality (P.66)	

The function of the Quick Set menu can be set from [ Camera Settings] (P.28) → [Custom QS]



1

Press the ◀▶ buttons in the Custom QS set-up page and select [QS1] or [QS2].

2

Select the key function to change the allocation by pressing the ◀▶ buttons, and open the Sub menu by pressing the ▶ or OK button.

3

Select the function to allocate by pressing the OK button, and press the ▶ or OK button to confirm.

4

When you have finished setting the allocation, press the MENU button to close the [Custom QS] menu.



CHANGING THE COLOR LCD MONITOR DISPLAY

It is possible to display/hide icons on the color LCD monitor as follows by pressing the  button.

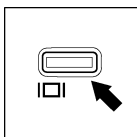
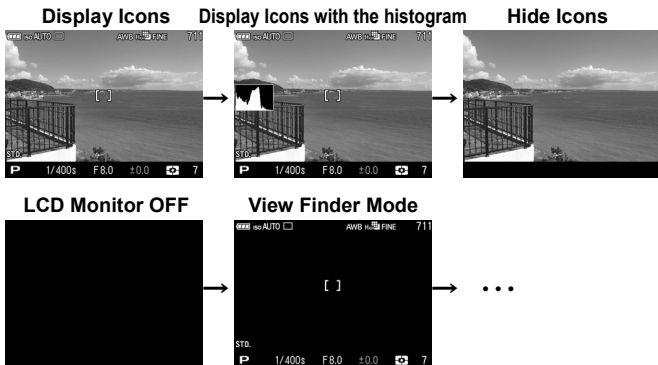

Each time the  button is pressed, the color LCD monitor display will change as follows.

OPERATION

Still Image Mode (P , A , S)
Display Icons → Display Icons with the histogram → Hide Icons → LCD Monitor OFF → View Finder Mode → ...
Still Image Mode (M)
Display Icons → Hide Icons → LCD Monitor OFF → View Finder Mode → ...
Movie Mode 
Display Icons → Display Icons with the histogram → Hide Icons → ...

- In the View Finder Mode, only Icons will be displayed. This mode is convenient for shooting with the optional View Finder.

REVIEWING

Still Image
Display Icons (Display date and time) (P.84) → Display Icons (Display Image Info) (P.84) → Hide Icons → Display Image Info Screen (P.87) → ...
Movie
Display Icons (It is not possible to switch)

GRID SEGMENT DISPLAY

It is possible to display the grid line when the camera is in Still Image Mode. This function is convenient when composing a picture.



[Capture Settings] (P.28) → Select the desired display type from [Grid Segment Display].

Off (Grid Line Off) (Default)	
— 4 (4 segments with a solid line)	--- 4 (4 segments with a dotted line)
— 9 (9 segments with a solid line)	--- 9 (9 segments with a dotted line)
— 16 (16 segments with a solid line)	--- 16 (16 segments with a dotted line)

INSERTING AND REMOVING THE CARD

The DP1 Merrill camera uses a SD memory card, SDHC memory card, SDXC memory card and Multimedia card to store data.

TO INSERT THE CARD

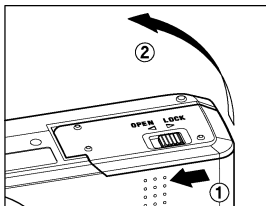

1

Turn off the camera and slide the Release lever to the OPEN position to open the Battery / Card Cover as shown in the illustration.

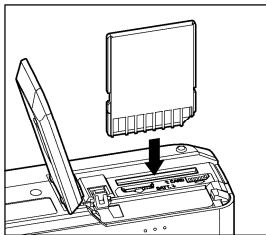

2

Insert the card in accordance with the instruction of Battery/Card chamber. Insert the card until it clicks.

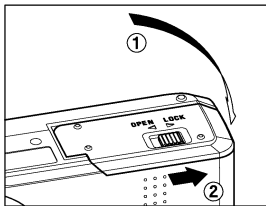

3

Close the Battery / Card Cover and Slide the Release lever to the LOCK position as shown in the illustration.

TIP

- It may be necessary to format the card before use. (See P.42)

TO REMOVE THE CARD

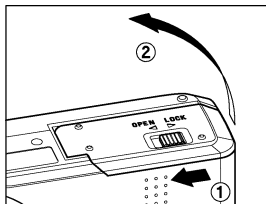

1

Turn off the camera and slide the Release lever to the OPEN position to open the Battery / Card Cover as shown in the illustration.

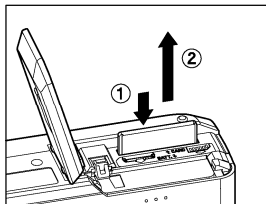

2

Push the card until it clicks and pull out it.

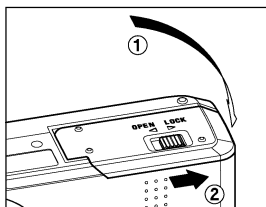

3

Close the Battery / Card Cover and slide the Release lever to the LOCK position as shown in the illustration.

WARNING!!

- While the Busy Lamp is on, please do not open the Battery Cover or Card Cover. By doing so, the camera will turn off and result in data loss. This could also cause damage to the camera and/or memory card.

TIP

- If the camera is turned off while the Busy Lamp is on, the camera will remain on until it has finished accessing the card.

FORMATTING THE CARD

New cards must be formatted before use. In addition, cards with corrupt or incompatible file systems may need to be formatted before use.

[ **Camera Settings**] (P.28) → Select [**Format**] and format the card.

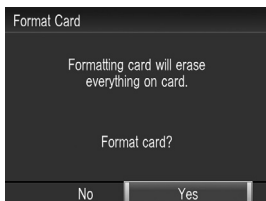

In [**Format**] menu, Select [**Yes**] by pressing the ◀▶ button and press the  button.

To cancel formatting, select [**No**] by using the ◀▶ button and press the  button.

CAUTION !!

- Formatting erases all card contents, including locked DP1 Merrill files and all non-DP1 Merrill files.

TIP

- Cards formatted in other cameras or devices may not operate correctly in the DP1 Merrill camera or may have reduced capacity. To store the maximum number of DP1 Merrill files, format the card in the DP1 Merrill camera before use.

SHUTTER BUTTON

The shutter button of the DP1 Merrill cameras has two positions. When you press the shutter button “halfway down”, the camera’s autofocus systems will activate. When pressing the button “all-the-way down”, the shutter will release to take a picture.

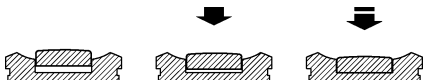

TIP

- Before you start to take pictures, we recommend that you operate the camera, to become familiar with the “halfway down” position and other features of the camera.
- Normally, if the card is not inserted in to the camera body, it is not possible to release the shutter. If you would like to release the shutter without a card, please set from [ **Camera Settings**] (P.28) → [**Release without Card**].

Disable (Default)	When the card is not inserted in the camera body, it is not possible to release the shutter.
Enable	It is possible to release the shutter, even if the card is not inserted in the camera body.

BASIC OPERATION

SELECTING THE EXPOSURE MODE

The features and the operation methods of the four different exposure modes of the camera are explained below.

WARNING !!

- In this section, the instruction is written on the assumption that [Key arrangement] of [Shooting Menu] (P.28) is in the initial setting. If the actual proceeding is different with the instruction manual, see P.112 for instruction of [KEY ARRANGEMENT].

SELECTING THE EXPOSURE MODE

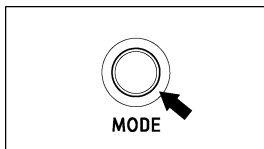

1

Press the Mode button (The mode selection will be displayed on the bottom of the LCD monitor.)

2

Select the desired exposure mode by using the Command Dial or press the **◀▶** buttons.

3

Press the **OK** button to return to shooting mode.

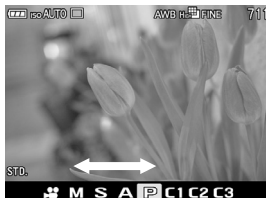

P PROGRAM AE

To make picture taking easier, the camera will automatically select an appropriate combination of shutter speed and aperture value, according to the brightness of the subject.



1 Set the Exposure Mode to the **P** position.
(The exposure indicator is illuminated in green.)

2 Press the shutter button “half-way” to verify the focus and take the picture.

WARNING !!

- When  is shown on the color LCD monitor, the camera is set slower than 1/25. If this mark is displayed, please use the flash (P.78) or a tripod.
- If the subject is too bright or dark, both shutter speed and aperture value indicators will blink and will show the limit values. If you take a picture with these settings, the picture will be overexposed or underexposed.

PROGRAM SHIFT

You can change the combination of shutter speed and aperture value, which were automatically selected by the camera. While turning the Command-Dial, the combination of shutter speed and aperture value will change within the range of combinations that give the equivalent exposure.

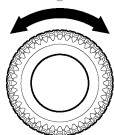

- It will be canceled automatically, after taking the picture.

A APERTURE PRIORITY AE

After you set the aperture, the camera will determine the appropriate shutter speed. If you select smaller apertures, depth of field will be greater. Larger apertures tend to blur the background, as depth of field will be shallower.

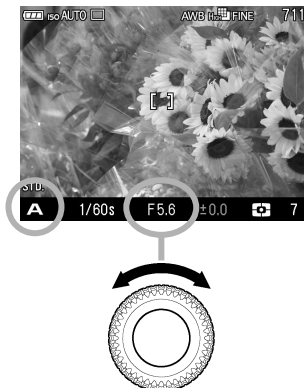

1

Set the Exposure Mode to the **A** position.

(The aperture value indicator is illuminated in green.)

2

Set the desired aperture value by rotating the Command Dial.

(The aperture value can be set in 1/3 stop increments from F2.8 to F16.)

3

Press the shutter button “half-way” to verify the focus and take the picture.

- Depending on the selected aperture value, the camera automatically sets the shutter speed in following range.

Aperture	Shutter Speed
F2.8 ~ F3.5	30s ~ 1/1250s
F4.0 ~ F5.0	30s ~ 1/1600s
F5.6 ~ F16	30s ~ 1/2000s

WARNING !!

- When  is shown on the color LCD monitor, camera shake may occur (the shutter speed is set slower than 1/25). If this mark is displayed, please use the flash (P.78) or a tripod.
- If the appropriate shutter speed is outside the range of suitable combinations due to the subject being too bright or too dark, the shutter speed indicator will blink. If the subject is too bright, set the aperture value to a smaller one (larger F-number). If the subject is too dark, set the aperture value to a larger one (smaller F-number) until the indicator stops blinking.

S SHUTTER SPEED PRIORITY AE

When you set the desired shutter speed, the camera will select the appropriate aperture value for correct exposure. You can achieve stop action effects by selecting a fast shutter speed, or give the feeling of motion to a moving subject by selecting a slow shutter speed.

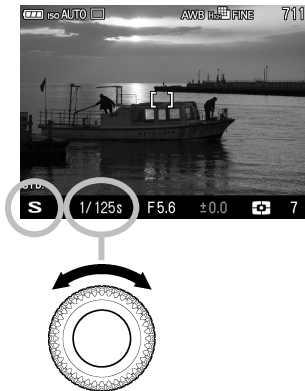

1

Set the Exposure Mode to the **S** position.
(The shutter speed value is illuminated in green.)

2

Set the desired shutter speed by rotating the Command Dial.
(The shutter speed value can be set in 1/3 stop increments from 30 seconds to 1/2000 seconds.)

3

Press the shutter button “half-way” to verify the focus and take the picture.

- Depending on the selected shutter speed, the camera automatically sets the aperture in the following range.

Shutter Speed	Aperture
30s ~ 1/1250s	F2.8 ~ F16
1/1600s	F4.0 ~ F16
1/2000s	F5.6 ~ F16

WARNING !!

- If the appropriate aperture value is beyond the range of the lens in use, due to the subject being too bright or too dark, the aperture value indicator will blink. If the subject is too bright, set the shutter speed to a faster one, or if the subject is too dark, set the shutter speed to a slower one, until the indicator stops blinking.

M MANUAL EXPOSURE

Set both the shutter speed and aperture value according to the indication of the exposure meter. You can change the exposure, as you desire.

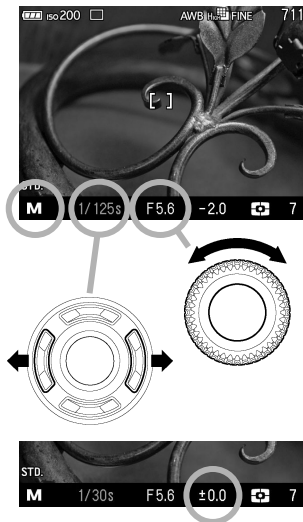

1

Set the Mode Dial to the **M** position.

(The shutter speed is illuminated in orange. The aperture value indicator is illuminated in green.)

2

Set the desired aperture value by rotating the Command Dial.

3

Set the shutter speed with the **◀▶** buttons to adjust the value of the exposure meter to **±0.0**.

- The exposure meter can display an exposure error of up to ± 3 stops from the correct exposure in $1/3$ steps. If the exposure error is more than three stops, the exposure meter will blink.

4

Press the shutter button “half-way” to verify the focus and take the picture.

- It is possible to change the combination of shutter speed and aperture value as follows.

Shutter Speed	Aperture
30s ~ 1/1250s	F2.8 ~ F16
1/1600s	F4.0 ~ F16
1/2000s	F5.6 ~ F16

- When the aperture value is set to an unavailable value by changing the shutter speed value, the shutter speed value will be changed to an available value automatically.
- When the shutter speed value is set to an unavailable value by changing the aperture value, the aperture value will be changed to an available value automatically.

FOCUSING

Adjustment of autofocus and manual focus operation are explained below.

FOCUS MODE

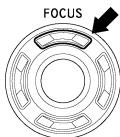

Each time the **FOCUS** button is pressed, AF mode (without an icon) and MF mode (**MF** icon) will alternate.

HOW TO USE AUTOFOCUS



Position the photographic subject within the centre of the composition and press the shutter button “half-way”.

- If autofocus is selected, the focusing point will be illuminated in green. (At the same time, the auto focus lamp will be illuminated in green.)

- If autofocus cannot set correctly, the focusing point will blink. (At the same time, the auto focus lamp will blink in red)
- The focusing distance is from 20cm to infinity.

Although your camera is equipped with highly precise AF system, in some cases autofocus cannot set correctly.

- Low-contrast subjects, such as blue sky or a blank wall, etc. or when the color of the subject is same as background
- The subject is located in a very low light environment
- Overlapping near and far objects, such as an animal behind a fence
- A subject, which moves at high speed

In such cases, please use one of the following focusing methods.

1. Use the Focus Lock function to focus on another subject, which has a similar focusing distance as your subject.

2. Set the lens to MF mode and focus manually.

SETTING THE FOCUS FRAME

The DP1 Merrill is equipped with two focusing modes. When using the “9 points select mode” it is possible to choose the desired focusing point from 9 different frames. When using “Free move mode” it is possible to move the desired point as you like. In addition, you can choose the size of the Focus Frame from three types [Spot], [Regular], [Large].

9 points select mode



Free move mode



Focusing point moving area

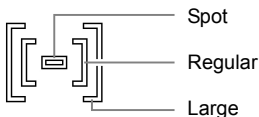

How to set :

Press the button.

- [9 points select mode] and [Free move mode] will be switched back and forth each time the button is pressed.
- When [9 points select mode] is selected, choose the desired focusing point by pressing the buttons.
- When [Free move mode] is selected, move the focusing point as you like by pressing the buttons (focusing points can be moved inside the focusing point moving area).
- When the Command Dial is rotated, you can change the size of the Focus Frame.

Confirm by pressing the button.

FOCUS LOCK

This photographic method is useful if the subject is not positioned within the selected focusing point.

1

Position the photographic subject into the selected focusing point, and focus by pressing the shutter button “half-way”.

2

When the subject is in focus, the selected focusing point will be illuminated in green. Press the shutter button to take the picture.

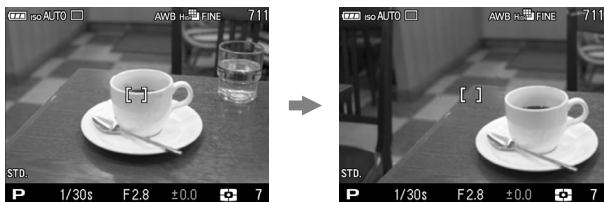

AF+MF MODE

It is possible to manually adjust the focus after verifying the AF.

1

Normal AF mode can be switched to AF+MF mode by selecting [Capture Settings] (P.28) → [AF+MF] → [On].



2

Press the FOCUS button and select **AF+MF** mode (AF/MF icon).

3

Press the shutter button halfway to verify focus.

4

While pressing the shutter button halfway and rotating the Focus ring, the display can be magnified. Adjust focus by rotating the Focus ring.

5

The enlarged display returns to normal one second after stopping rotation of the Focus ring. Compose the image as desired and take the picture.

- To return to normal AF mode, select **[Off]** in step **1**.
- The enlarged display will be magnified from the selected focusing point of the LCD monitor by pressing **OK** button. It is possible to set the enlarged area to be the same as the focusing point selection. See **P.50** for information regarding focusing point.

AF LIMIT MODE

It is possible to use the AF Limit mode ( icon) which is suitable for general photography. The focusing distance will be from 1m to infinity and the AF speed will be faster.

1

Limit mode can be set by selecting [ **Capture Settings**] (**P.28**) → [**AF Limit Mode**] → [**On**]. (AF Limit mode will be added to the Focus mode.)

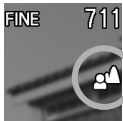

2

Press the **FOCUS** button and select the AF Limit mode ( icon).

- If AF Limit mode is not required, select **[Off]** in step **1**.

SPEED PRIORITY AF

The Speed Priority AF enables faster autofocus by freezing the LCD monitor while focusing.

Normal AF mode can be switched to Speed Priority AF mode by selecting [Capture Settings] (P.28) → [Speed Priority AF] → [On].

CAUTION !!

- As the LCD monitor freezes while the camera is autofocusing, a still image will be displayed when the shutter button is pressed halfway until the AF is finished.
- To return to normal AF mode, select [Capture Settings] (P.28) → [Speed Priority AF] → [Off].

MANUAL FOCUS

In situations where autofocus or focus lock is not effective, you can focus manually.



1 Set the focus mode to MF mode by pressing **FOCUS** button several times. (icon and “the scale bar” will be displayed on the color LCD monitor).

2 Turn the Focus ring until you get a clear sharp image.



- The green bar which appears on both sides of the meter on the scale bar shows the depth of field. If you select larger apertures, the depth of field will be shallower (area in focus is narrower) and if you select smaller apertures, the depth of field will be greater (area in focus is wider).

FOCUSING WITH MAGNIFICATION DISPLAY

It is possible to magnify the display by pressing the **OK** button while in MF mode. Press the button again to change to the normal display.

- Whilst the display is enlarged, the  is displayed on the color LCD monitor. Press the shutter button “half-way” to return to the original display.
- The enlarged display will be magnified from the selected focusing point of the LCD monitor by pressing **OK** button. It is possible to set the enlarged area to be the same as the focusing point selection. See **P.50** for information regarding focusing point.
- Whilst the display is enlarged, it is possible to change the magnification ratio by rotating the Command-Dial. (Normally the magnification ratio is x8.0, it is possible to change to x4.0 or x12.0)

WARNING!!

- The focus point on the scale bar and the depth of field may differ from the actual distance. Please use it as a guide only.

TIP

- It is possible to change the indicator of the scale bar. Select **m (meters)** or **ft (feet)** from [ **Camera Settings**](P.28)→[**MF Distance Scale Units**].

OPERATION OF THE DRIVE MODE

Operation of the self-timer, and other functions of the camera are explained by the following:



Operation of The Drive Mode can be set in Quick Set Menu (P.35) or [Capture Settings] (P.28) → [Drive Mode].

	Single Capture (Default)
	Continuous
	Self Timer 2 sec.
	Self Timer 10 sec.
	Interval timer
	Unlimited Shooting

SINGLE FRAME SHOOTING



[Single Capture]

When you press the shutter button in the single frame-shooting mode, only one frame will be exposed. Then the camera will be ready for the next shot by advancing one frame. Single frame shooting mode is recommended for ordinary photography.

CONTINUOUS SHOOTING



[Continuous]

In this mode, when you keep the shutter button fully depressed, the camera will take pictures continuously.



CAUTION !!

- Images taken in rapid succession, such as during Continuous shooting, are initially stored in the camera's internal memory buffer. Once the memory buffer is full, the shutter will be disabled until some images have been processed in the camera.



The number on the lower right of the color LCD monitor is the buffer capacity. It is the maximum number of frames for continuous shooting. (If the maximum number of frames for continuous shooting exceeds 9 frames, the display will not change from 9)

- The maximum number of frames and speed of continuous shooting are as follows:

		Image Size (Resolution mode)		
		 HIGH	 MED	 LOW
Image Quality	JPEG	7	14	14
		4.0	5.0	5.0
	RAW	7	14	14
		4.0	5.0	5.0
	RAW+JPEG	7	14	14
		4.0	5.0	5.0

The upper rows show the maximum number of frames, the lower rows show the maximum shooting speed in continuous mode (frames per second).

SELF TIMER

When you want to include yourself in the picture or avoid camera shake, please use the self-timer.



[Self Timer 2 sec]

The shutter will be released 2 seconds after the shutter button is fully depressed.



[Self Timer 10 sec]

The shutter will be released 10 seconds after the shutter button is fully depressed.

After composing the picture, press the shutter button “half-way” and adjust the focusing. Then, press the shutter button the rest of the way and the self-timer will activate. During the self-timer operation you will hear an electronic beeping sound. The beeping sound will be much faster during the last two seconds, before the shutter is released.

- When [ **Camera Settings**] (P.28) → [**Sound Settings**] → [**Operation Sound**] menu is set to [**Off**], the electronic sound will not beep even if the self-timer is operated.
- If you want to cancel the self-timer operation, please turn off the camera.

INTERVAL TIMER



[Interval timer]

It is possible to take pictures automatically at selected intervals.

WARNING !!

- The interval timer shooting will be terminated automatically if the battery is empty. We recommend using the AC adapter “SAC-5” (sold separately).

1

Select [**📷 Capture Settings**] (P.28) → [**Drive Mode**] → [**Interval timer**], and press the **▶** button to move the interval timer setting screen. (When the **OK** button is pressed after selecting [**Interval timer**], the current setting will be applied.)

When the Interval timer shooting mode is set in the Quick Set menu (P.35), select [**INT**] and press the **□** button to display the Interval timer setting screen (By pressing the **OK** button or the shutter button halfway after selecting [**INT**], the current setting will be applied.).

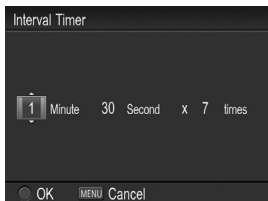

2

Set the desired interval and number of exposures by using the **◀▶** buttons. (Interval can be set from 15 seconds to 60 minutes and number of exposures can be set from 2 to 99 times.)

3

Press the **OK** button to apply the setting, and press the **MENU** button to go back to shooting mode.

4

Press the shutter button to start the interval timer shooting.

- During the interval timer shooting, the next exposure interval begins and the numbers of remaining exposures will be displayed.
- During the interval timer shooting, the auto focus lamp will blink in green.
- When the focus mode is set to AF, the AF will be locked at the first frame. From the second frame, pictures will be taken with the same focus position as the first frame.
- When the focus mode is set to MF, it is possible to change the focus during the interval timer shooting by turning the Focus ring.
(It is not possible to magnify the display from the second frame.)
(If you wish to keep the same focus position, ensure the Focus ring is not turned during the interval timer shooting.)

- Exposure value is measured at each interval shooting. If you wish to take pictures with the same exposure value, set the Exposure Mode to Manual Exposure or fix the exposure value by pressing the AEL Button before shooting.
- To terminate the interval timer shooting, press the Shutter button.
- Interval timer shooting cannot be used with the Auto Bracketing function.

WARNING !!

- Once you set the Interval Timer , the camera will continuously hold that Interval Timer. To dismiss the Interval Timer, switch to another modes in [**Drive Mode**].
- Depending on the settings, it takes time process the image. It may make the actual interval time longer than the selected time.

UNLIMITED SHOOTING



[Unlimited Shooting]

While holding down the shutter button, you can continue to shoot until the card is full.

- The image size is fixed to Infinite Shooting size (1632×1088) and the image quality will be JPEG FINE.
- The maximum shooting speed will be about 1.5 frames per second.

WARNING !!

- Continuous shooting will be terminated automatically if the battery level is low.
- The writing speed may be slow or continuous shooting will be terminated depending on the card in use. We recommend using high speed card.

ADVANCED OPERATION







This section explains the application of the more advanced functions of your camera, when composing the expressions of your picture.

SETTING THE WHITE BALANCE (WB)

The color of light reflected by an object can vary depending on the color of the light source illuminating it. For example, a neutral colored object will reflect reddish light under incandescent lighting, and greenish light under fluorescent lighting. The human brain is able to compensate for differences in the color of a light source, allowing us to see white objects as white, independent of the lighting condition. Film cameras rely on special color-correcting filters and film types to adjust for these differences in lighting. Digital cameras, however, are able to use software to mimic the adjustments made by the brain, so that colors that appear white to the human eye also appear white in your photographs.



WHITE BALANCE OPTIONS

	OPTION	COLOR TEMP.	DESCRIPTION
AWB	Auto (Default)	—	Select this setting to allow the camera to automatically determine the appropriate white balance adjustments.
	Daylight	Approx. 5400 K	Select this setting when taking pictures in full sunlight.
	Shade	Approx. 8000 K	Select this setting when taking pictures in the shade under sunny skies.
	Overcast	Approx. 6500 K	Select this setting when taking pictures under cloudy, overcast skies.
	Incandescent	Approx. 3000 K	Select this setting when taking pictures indoors under incandescent (tungsten) lighting.
	Fluorescent	Approx. 4100 K	Select this setting when taking pictures indoors under fluorescent lighting.
	Flash	Approx. 7000 K	Select this setting when taking pictures with the Sigma EF-140 DG SA-STTL flash.
	Custom	—	Select this setting when using a custom white balance. Use the "Set Custom WB" menu option to create a custom white balance setting. The "Custom" option will not be available if no custom white balance has been set.

The White Balance can be set in Quick Set Menu (P.35) or [Shooting Menu] (P.28) → [White Balance].

SETTING A CUSTOM WHITE BALANCE

For more precise control of the white balance setting or when photographing under unusual lighting conditions, the "Set Custom WB" option can be used to capture a sample of neutral object in a scene to be used for color correction.

1

To capture a custom white balance image, please select [**📷 Capture Settings**] (P.28) → [**White Balance**] → [**Custom** , then press the **▶** button. (When the **OK** button is pressed after selecting [**Custom**], the current white balance setting will be set.)

When a custom white balance is set in the Quick Set menu (P.35), select [**📷**] and press the **|□|** button to display the custom white balance setting screen (By pressing the **OK** button or the shutter button halfway after selecting [**📷**], the current setting will be applied.)

2

Under the lighting conditions that will be used for the final photograph, frame a white color object, such as a sheet of white paper or a white wall, so that it fills the frame in the center of the color LCD monitor, and then press the shutter button.

If a valid white balance settings was captured, a message “**White balance image captured successfully**” will appear on the color LCD monitor that the white balance image was captured successfully.

If the capture was not successful, “**Failed ! Please retry the custom WB capture.**” will be displayed on the color LCD monitor.

Press the shutter button to capture a white balance image once again. To dismiss the capture, press the **MENU** button.

SETTING THE SENSITIVITY (ISO EQUIVALENCY)



The photosensitivity of digital cameras is described in terms of “ISO equivalent” like silver-halide film cameras. (ISO sensitivity **P.121**)

The ISO Sensitivity can be set in Quick Set Menu (P.35) or [📷 Capture Settings] (P.28) → [ISO Sensitivity].

ISO Auto (ISO AUTO) (Default)	ISO 800
ISO 100	ISO 1600
ISO 200	ISO 3200
ISO 400	ISO 6400

CAUTION !!

- When Exposure Mode is set to **M** mode, it is not possible to select [ISO Auto]. When AUTO is selected in **S**, **A**, **P** mode and then change to M mode, ISO200 will be applied.

ISO AUTO RANGE

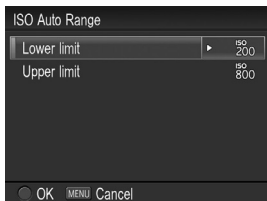

It is possible to set the Lower limit and Upper limit of the ISO Sensitivity in ISO Auto mode.

1

Select [📷 Capture Settings] (P.28) → [ISO Sensitivity] → [ISO Auto], and press the ▶ button to move the ISO Auto Range setting screen. (When the **OK** button is pressed after selecting [ISO Auto], the current setting will be applied).

When the ISO Auto Range is set in the Quick Set menu (P.35), select [ISO AUTO] and press the  button to display the ISO Auto Range setting screen. (By pressing the **OK** button or the shutter button halfway after selecting [ISO AUTO], the current setting will be applied.)

2

Set [Lower limit] and [Upper limit].

Lower limit

ISO 100	ISO 400
ISO 200 (Default)	

Upper limit

ISO 200	ISO 1600
ISO 400	ISO 3200
ISO 800 (Default)	ISO 6400

CAUTION !!

- It is not possible to set the same value to the Lower limit and Upper limit and reversed value.

By default, the ISO sensitivity step setting is 1 EV. However, it is possible to select 1/3 EV.

It is possible to set the ISO sensitivity from [📷 Capture Settings] (P.28) → [ISO Sensitivity Step].



1 EV (Default)	It is possible to set the ISO sensitivity step 1EV.
1/3 EV	It is possible to set the ISO sensitivity step 1/3EV.

When the 1/3 EV is selected, the following ISO sensitivity can be set.

ISO AUTO	ISO 250	ISO 800	ISO 2500
ISO 100	ISO 320	ISO 1000	ISO 3200
ISO 125	ISO 400	ISO 1250	ISO 4000
ISO 160	ISO 500	ISO 1600	ISO 5000
ISO 200	ISO 640	ISO 2000	ISO 6400

IMAGE FILE SETTING

The file size changes depending on resolution mode and recording quality selected.

		Image Size (Resolution mode)		
		 HIGH 4704×3136	 MED 3264×2176	 LOW 2336×1568
Image Quality	RAW (RAW)	45 MB	24 MB	12 MB
	FINE (JPEG)	10 MB	5 MB	2.5 MB
	NORM (JPEG)	5.6 MB	2.7 MB	1.4 MB
	BASIC (JPEG)	4.2 MB	2 MB	1 MB

* The file sizes change depending on subjects.

IMAGE QUALITY

It is possible to record images in the widely used JPEG or RAW formats.

RAW images are recorded without digital processing in the camera body and require post-processing with **Sigma Photo Pro** software which can convert RAW images to JPEG or TIFF format.

IMAGE SIZE SETTING



Image Size Setting can be set in Quick Set Menu (P.35) or [Capture Settings] (P.28) → [Image Size].

 HIGH (Default)	 MED	 LOW
---	--	--

IMAGE QUALITY SETTING



Image Quality Setting can be set in Quick Set Menu (P.35), or [📷 Capture Settings] (P.28) → [Image Quality].

FINE (JPEG) (Default)	NORM (NORMAL)(JPEG)
BASIC (JPEG)	RAW (RAW)
RAW+JPG (RAW+FINE(JPEG) simultaneous)	

TIP

- When **RAW+JPG** is selected, the Image Quality of JPEG will be **FINE**.
- When **RAW+JPG** is selected, the selected Image Size will be applied to both the RAW and JPEG files.

COLOR SPACE

It is possible to select sRGB, which is a common color space or Adobe RGB, which is mainly used for commercial printing, and other industrial purposes.

Color Space can be set in [📷 Capture Settings] (P.28) → [Color Space].

sRGB (Default)	Adobe RGB
-----------------------	------------------

CAUTION !!

- Please set the color space to sRGB for regular usage. If you select Adobe RGB, please be sure to use the **Sigma Photo Pro** software or another image processing software supporting DCF 2.0.

PICTURE SETTINGS

It is possible to adjust the recording image parameter (contrast, sharpness and saturation).

● Contrast

Contrast can be increased by moving the cursor to + side, or decreased, preserving image detail, by moving the cursor to - side.

▣ Sharpness

It is possible to make the pictures appear sharper, by moving the cursor to + side, or softer by moving the cursor to - side,.

⚡ Saturation

It is possible to increase saturation thus making pictures appear vivid, if the cursor is moved to + side. Moving the cursor to - side, decreases saturation and makes images less vivid.

Picture Settings can be set in [**📷 Capture Settings**] (P.28) → [**Picture Settings**].

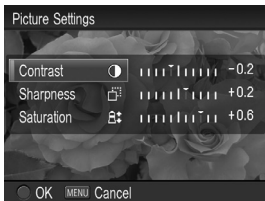

Use the **⬆** arrows on the 4-way controller to select [**Contrast**], [**Saturation**], [**Sharpness**] from [**Picture Settings**], then press the **⬅** arrows on the 4-way controller to adjust the compensation.

Press the **OK** button to apply the setting or the **MENU** button to close the sub-menu without making any changes.



If you adjust image parameters, their icon is displayed on the left of the color LCD monitor.

TIP

- JPEG files are compressed after a parameter adjustment. In the case of the RAW format, parameter information is recorded without adjustment. It is possible to re-adjust RAW images using **Sigma Photo Pro** software.

SELECTING THE METERING MODE



The camera has three advanced metering modes.

The Metering Mode can be set in Quick Set Menu (P.35) or [Camera Capture Settings] (P.28) → [AE Metering Mode]

	Evaluative (Default)
	Center Weighted Average
	Spot

EVALUATIVE METERING

The camera divides its screen into 256 and measures the brightness of the scene by independently measuring each segment of the focusing screen and analyzing the correct exposure for the main subject under any lighting situation. Even under strong back lighting or complex lighting situations, the camera will give you the correct exposure.

CENTER WEIGHTED AVERAGE METERING

The camera will measure the average brightness of the entire scene with additional emphasis on the center area. It will determine the most suitable exposure with respect to lighting conditions.

SPOT METERING

The camera will measure the brightness only inside of the center focusing point on the color LCD monitor. This mode is suitable when you wish to set exposure for a portion of the scene and ignore the influence of rest of the scene.

AE LOCK

The camera will fix and memorize the exposure value whilst the “AE” Lock button is depressed. When you wish to lock the exposure of a subject off-center, AE lock is very useful. Use of this function with Spot Metering Mode is recommended.

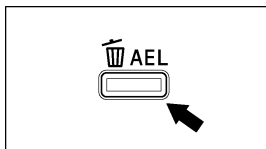

1

Center the subject, for which you wish to lock the exposure, inside the color LCD monitor and press the **AEL** button.

(The exposure value is memorized and AEL is displayed in the upper part of the color LCD monitor.)



2

Compose the picture and press the shutter button.

- It is possible to continue taking pictures with the memorized exposure value until this setting is disabled by pressing the **AEL** button again.

SETTING THE AEL BUTTON

It is possible to use the **AEL** button to select settings other than AE Lock [**AEL**].

The AE Lock can be set in [**Camera Capture Settings**] (P.28) → [**AEL Button Settings**].

AEL (Default)
Center AF Lock
Center AF Lock+AEL

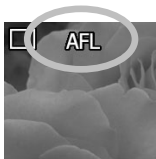

[Center AF Lock]

Ensure the subject is within the center focusing point and press the **AEL** button to activate and lock the autofocus. Please note, only the center focusing point will be used when the **AEL** button is pressed. The exposure will only be locked when the shutter button is depressed “half-way”.



[Center AF Lock + AEL]

Ensure the subject is within the center focusing point and press the **AEL** button. This will activate and lock the autofocus and exposure. Please note, only the center focusing point will be used when the **AEL** button is pressed.

HALF PRESSED AEL

It is possible to set the exposure lock when the shutter button is pressed “half-way” or cancel the exposure lock.

The Half Pressed AEL mode can be set in [**Capture Settings**] (P.28) → [**Half Pressed AEL**].

OFF	The exposure will not be locked while pressing the shutter button “half-way”. The exposure will be determined when depressing the shutter button.
ON (Default)	The exposure will be locked when the shutter button is pressed “half-way”. While pressing the shutter button is “half-way”, the exposure will not change.

EXPOSURE COMPENSATION



If you want to intentionally overexpose or underexpose the picture, use this function.

Select the desired compensation value by using the ◀▶ buttons.

- Exposure compensation can be set in 1/3 stop increments from +3.0 to -3.0 stops.

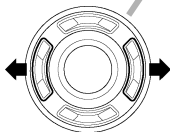

CAUTION !!



- The exposure compensation will not disable automatically. After taking the picture, set the compensation value to ± 0.0 by pressing ◀▶ button.
- Exposure compensation function cannot be used with Manual Operation mode.

AUTO BRACKETING

This function of the camera lets you take a sequence of pictures of the same subject at three different exposure levels; Appropriate Exposure, Under Exposure and Over Exposure. If it is difficult to determine the proper exposure, please use this function.



1

Select [ Capture Settings] (P.28) → [Auto Bracketing] → [Bracketing Amount], and press the  button or the  button.

2

Use the  buttons to set the bracketing amount.

- It can be set in 1/3 stop increments up to ± 3

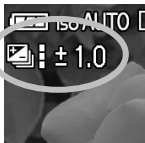

3

Press the  button to confirm, press the shutter button “half-way” to return to shooting mode. (The Auto Bracketing icon will be displayed on the bottom right corner of the LCD monitor.)

- The camera will take three pictures in the following sequence; Appropriate exposure, under exposure and over exposure.
- The operations in each Drive Mode are shown below.

Single Capture	Each time the shutter button is pressed, an image will be taken one frame at a time.
Continuous	Three frames will be taken continuously by pressing and holding the shutter button.
Self Timer 2 sec.	2 seconds after pressing the shutter button, three frames will be taken continuously.
Self Timer 10 sec.	10 seconds after pressing the shutter button, three frames will be taken continuously.
Infinite Shooting	While holding down the shutter button, three frames will be taken continuously and repeated.

- This function cannot be used with the interval timer shooting.



- The exposure bracketing can be used with 4 different modes.

P Mode	Both shutter speed and aperture value will be changed.
A Mode	Only shutter speed will be changed.
S Mode	Only aperture value will be changed.
M Mode	Only shutter speed will be changed.

WARNING !!

- Once you set the auto bracketing mode, the camera will continuously hold that auto bracketing mode until you set the bracketing amount to “±0.0”.
- Auto Bracketing function cannot be used with the flashgun.

■ Auto bracketing icon will change as follows depending on the frame number.

First Frame	Second Frame	Third Frame
		

■ It is possible to change the Auto Bracketing Order.

The Auto Bracketing Order can be set in [📷 Capture Settings] (P.28) → [Auto Bracketing] → [Bracketing Order]

0 → - → + (Default)	appropriate exposure → under exposure → over exposure
- → 0 → +	under exposure → appropriate exposure → over exposure
+ → 0 → -	over exposure → appropriate exposure → under exposure

Auto Bracketing mode can be used in combination with Exposure Compensation.

You can take pictures with Auto Bracketing mode based on a compensated exposure, which you set.

To do so, please set both the Auto Bracketing mode and Exposure Compensation mode as desired.

The combined value (Exposure Compensation and Auto Bracketing) will be indicated on the viewfinder display.

Example : Exposure Compensation +1.7 with Auto Bracketing amount 1.0

First Frame	+1.7 (Exposure compensation +1.7 & no shift value)
Second Frame	+0.7 (Exposure compensation +1.7 & shift value -1.0)
Third Frame	+2.7 (Exposure compensation +1.7 & shift value +1.0)

COLOR MODE

It is possible to select the desired Color mode depending on the shooting conditions. In addition to the above settings, it is also possible to select Sepia and Monochrome (B&W) photography modes.

The Color Mode can be set in the Quick Set Menu (P.35) or [Capture Settings] (P.28) → [Color Mode]

STD. Standard (Default)	Standard color mode for various situations.
VIVID Vivid	Saturation and contrast are enhanced for making pictures appear vivid.
NTR. Neutral	Subdued saturation and contrast makes images natural.
PORT. Portrait	This color mode makes skin tone soft. It is ideal for portraits.
LAND Landscape	This mode makes blue and green more vivid and emphasizes pictures.
B/W B&W	It is possible to take Monochrome pictures.
SEPIA Sepia	It is possible to take Sepia and monotonous pictures.



- The selected color setting icon is displayed on the color LCD monitor.

TIP

- It is possible to make pictures according to your intension by the combination of Color Mode and Picture Settings. For example, when Color Mode is set to Vivid and the cursor of Saturation in Picture Settings is set to + side, pictures will be made more vivid.

WARNING !!

- It is possible to select the Color Mode to **B&W** or **Sepia**, only when the Image Quality is set to **JEPG (FINE, NORM., BASIC)**.
- When the Color Mode is set to **B&W** or **Sepia** and Image Quality is changed to **RAW** or **RAW+JPG**, the Color Mode will be automatically changed to **STD.**(Standard).

AUTO ROTATE

It is possible to record the vertical image information to images.

The Auto Rotate can be set by [ **Capture Settings**] (P.28) → [**Auto Rotate**].

Off	The vertical image information will not be recorded.
On (Default)	The vertical image information will be recorded.

- When vertically orientated images are reviewed, they will automatically rotate and be displayed vertically.
- When vertically orientated images are reviewed in Sigma Photo Pro, they will automatically rotate and be displayed vertically.
- When vertically orientated images are rotated by pressing [ **Playback Menu**] → [**Rotate**], this rotated orientation will be stored.

WARNING !!

- If the images are taken while the camera is pointed up or down, the vertical position information may not be recorded properly.

CUSTOM MODE

It is possible to customize the Custom Mode Setting. (Up to three patterns can be stored.)

The following settings are available.

- All items in [**📷 Capture Settings**] (Blue Tab) (P.28)
- Exposure mode (**M, S, A, P**) (P.44)
- Setting the focus frame (P.50)
- Exposure compensation (P.71)

WARNING !!

- It is not possible to store the Movie mode.

SAVE THE CUSTOM MODE SETTING

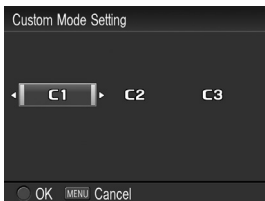

1

Set the above settings to your desired combination.

2

In [**📷 Camera Settings**] (P.28) → [**Custom Mode Setting**], select from **C1**, **C2** or **C3** by using **◀▶** buttons. After selecting, press the **OK** button. A confirmation dialog will appear.

3

Press the **OK** button to apply the setting or the **MENU** button to return to the set-up menu without making any changes.

WARNING !!

- When the new setting is saved, the previous stored setting will be overwritten.

LOAD THE CUSTOM MODE SETTING

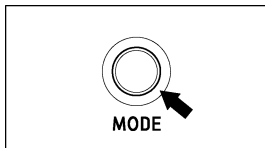

Press the Mode button and set to **C1**, **C2** or **C3**.

In custom mode, it is possible to change the above settings temporarily (except Exposure Mode).



If the setting is changed, ★ mark will appear in Function Display.

Return to original registered setting by doing the following.

- Turn the camera off (this includes the camera turning off automatically with the Auto Power Off function)
- Press the Mode button and set to another position.

USING THE EXTERNAL FLASH

This section explains how to use a compact, dedicated, external flashgun.

THE EXTERNAL FLASH

The DP1 Merrill camera is equipped with a hot shoe, allowing the use of you a compact, dedicated, external flashgun.

ELECTRONIC FLASH EF-140 DG SA-STTL (SOLD SEPARATELY)

- This compact design flashgun has a maximum Guide Number of 14 (ISO100 / m).
- The TTL exposure is controlled by the automatic S-TTL system.
- This flash unit uses two “AAA” type Ni-MH batteries allowing it to have a compact design.
- It is also possible to use the EF-140 DG SA-STTL in manual mode.
- It can be used with the SD1 / SD15 / SD14 digital SLR camera and its exposure will be controlled with the S-TTL system.

USING THE EXTERNAL FLASH

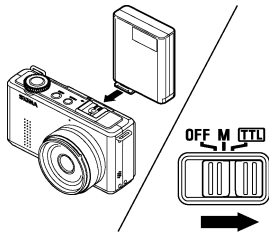

1

turn off the camera and attach the flashgun by referring to its instruction manuals.

2

Turn on the camera and set the flashgun switch to TTL.

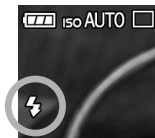

3

Make sure that the Flash Mode icon is displayed on the LCD monitor.

CAUTION!!

- While the built-in flash is charging, ⚡ and Auto Focus Lamp blink and the shutter cannot be released.

- Flash photography can be used in the following range. (P Mode)

ISO	Flash Exposure Range
ISO100	0.2m ~ 5.0m
ISO200	0.2m ~ 7.1m
ISO400	0.2m ~ 10.0m
ISO800	0.2m ~ 14.1m
ISO1600	0.2m ~ 20.0m
ISO3200	0.2m ~ 28.3m
ISO6400	0.2m ~ 40.0m





TIP

- If the ISO sensitivity setting is set to [ISO AUTO] and the external flash is used, the value set in [Lower limit] of [ISO Auto Range] will be applied.

SETTING THE FLASH MODE

It is possible to select other flash modes such as Exposure Compensation mode or Red-Eye Reduction mode.

The Flash Mode can be set in the Quick Set Menu (P.35) or [Capture Settings] (P.28) → [Flash] → [Flash Mode].

	Normal Flash (Default)
	Redeye
	Slow Sync.
	Redeye + Slow

NORMAL FLASH

When you pop-up the built-in flash, you can use your camera in this mode.

- Please use this mode for ordinary photography.

RED-EYE REDUCTION FLASH (Redeye)

When taking a picture with flash, sometimes the person's eyes reflect the flash light and the "red-eye" phenomenon will appear in the picture. In order to avoid this effect, the flash will blink several times, for about one second before the picture is taken, in order to reduce the effect of this phenomenon.

- Depending on the lighting and subject conditions, the Redeye Reduction flash may not completely eliminate the red-eye in all cases.

SLOW SYNCHRO MODE

When using the flash with **P/A** mode, the shutter speed value is limited to faster than 1/30. The slow synchro mode changes the shutter speed up to 30 second depending on light condition. This mode is suitable for a portrait in a nightscape.

CAUTION!!

- The Flash Mode can not be set if the flashgun is not attached to the camera, or the flashgun is turned off.
- It is not possible to use the Red-eye reduction flash when Manual Flash mode is selected on the external flash unit.

FLASH EXPOSURE COMPENSATION

It is possible to compensate the flash output level without changing the background's exposure.

The Flash Exposure Compensation can be set from [**Camera** Capture Settings] (P.28) → [Flash] → [Flash Exposure Compensation].

Select the desired compensation value by using the  buttons.

- Flash Exposure compensation can be set in 1/3 stop increments from +3.0 to -3.0 stops.



- When the Flash Exposure Compensation is set, the icon and compensation value will be displayed on the left of the LCD monitor.

CAUTION!!

- The flash exposure compensation can not be set if the flashgun is not attached to the camera, or the flashgun is turned off.
- The flash exposure compensation will not disable automatically. After taking the picture, set the compensation value to ± 0.0 by above procedure.

REVIEWING AND DELETING IMAGES

This section explains how to review and delete images after they have been captured.

TIP

- The DP1 Merrill may not be able to display images captured by other cameras, or “DP1 Merrill” images that have been renamed or moved from the **DCIM** folder on the card.

QUICK PREVIEW

The DP1 Merrill camera can be set to automatically display a preview of each image immediately after it is taken. This is useful for instantly checking exposure and framing.

CHANGING THE QUICK PREVIEW DURATION

The Quick Preview image can be completely disabled, if you select ‘Off’, or displayed for 2, 5, or 10 seconds.

The Quick Preview Duration can be set from [ **Capture Settings**] (P.28) → [**Quick Preview**].

QUICK PREVIEW OPTIONS

Off	No preview image is displayed.
 2 sec. (Default)	Preview image is displayed for 2 seconds.
5 sec.	Preview image is displayed for 5 seconds.
10 sec.	Preview image is displayed for 10 seconds.

-  icon is the recommended setting for conserving the electronic power.

TIP

- To manually turn off the Quick Preview image, press the shutter button half-way.
- It will not be possible to zoom in to the preview image, or change to another image while the Quick Preview is up.

REVIEWING IMAGES

The pictures captured by the DP1 Merrill can be reviewed in various ways.

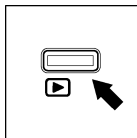

To review images captured by the DP1 Merrill camera press the  button on the back of the camera. The last image recorded on the card will be displayed on the color LCD monitor.



Press the  button to display an image on the color LCD monitor.

Press the  button again to change to shooting mode.



TIP

- Even if the camera is switched off, images can be reviewed by pressing and holding the  button for 2 seconds.
- If no new images have been captured, the last reviewed image will be displayed.
- If there are no images on the card, an error message “**No images on Memory card**” will be displayed.
- When reviewing images, if the  button is pressed or the shutter button is pressed “half-way”, the DP1 Merrill will be changed back to shooting mode.

VIEWING ONE IMAGE AT A TIME

Press the  button on the back of the camera to see the recorded images in Single-Image View.

WHILE IN SINGLE-IMAGE VIEW:



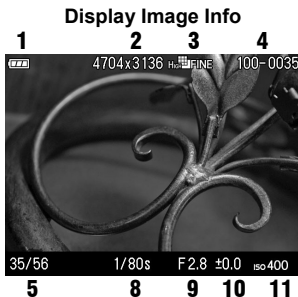
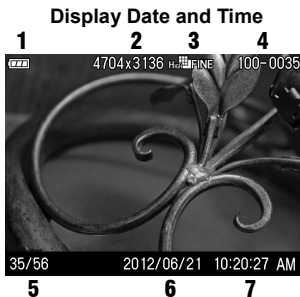

- Press the  button to see the next image.
- Press the  button to see the previous image.
- Press the  button to switch the information as follows (P.39).



1	Battery Level Indicator
2	Image Size
3	Image Quality
4	Folder numbering - File numbering
5	file number/total files recorded
6	Date

7	Time
8	Shutter Speed
9	F Number
10	Exposure Compensation Value*
11	ISO Sensitivity

TIP

- To scroll through images more quickly, press and hold the   buttons. Images will advance automatically until the button is released.
- The first and last recorded images on the card are linked. Pressing the  button while the first image is displayed brings up the last recorded image on the card. Pressing the  button while the last image is displayed brings up the first recorded image on the card.

MAGNIFYING IMAGES (ZOOMED-IN VIEW)

Reviewed images can be magnified, making it possible to check image details and focusing.

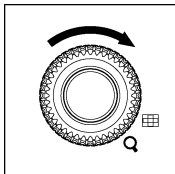





While reviewing images, rotate the Command-Dial to the  position.





The magnification ratio will be changed as follows.

Original → X1.25 → X1.6 → X2.0 → X2.5 → X3.15 → X4.0 → X5.0 → X6.3 → X8.0 → X10.0

WHILE IN ZOOMED-IN VIEW:

- Rotate the Command-Dial to the  position to increase magnification.
- Rotate the Command-Dial to the  position to decrease magnification.
- Press the  buttons or the  buttons to pan around the image.
- Press the  button to return to the original ratio.

CAUTION!!

- While magnifying an image, the  buttons cannot be used to change images. Rotate the Command-Dial to the  position or press the  button to return to the original ratio (Single-image View), then use the  buttons to change images.

VIEWING NINE IMAGES AT A TIME (CONTACT SHEET VIEW)

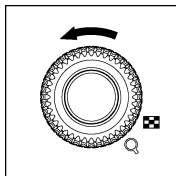

Images can be viewed in a "contact sheet" of nine thumbnail images.



While reviewing images, rotate the Command-Dial to the  position.



WHILE IN CONTACT SHEET VIEW:

- Press the  buttons to change the thumbnail image selection.
- Rotate the Command-Dial to the  position, the selected thumbnail image will be reviewed.

TIP

- The first and last page are linked. The first page is displayed after the last page.

VIEWING IMAGE INFORMATION

The Image Info Screen contains additional information about each image.

Press the  button several times from the Single-Image or Zoomed-In View.

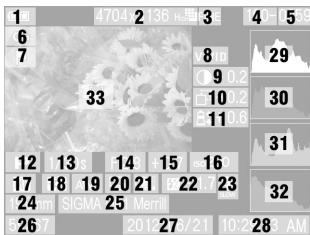
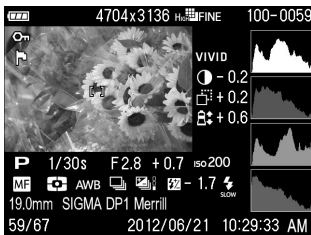



1	Battery Level Indicator
2	Image Size
3	Image Quality
4	Folder numbering
5	File numbering
6	Lock *
7	Mark *
8	Color Mode
9	Contrast
10	Sharpness
11	Saturation
12	Exposure Mode
13	Shutter Speed
14	F Number
15	Exposure Compensation Value
16	ISO Sensitivity
17	Focus Mode *

18	Metering Mode
19	White Balance
20	Drive Mode
21	Auto Bracket *
22	Flash Exposure Compensation Value
23	Flash Mode *
24	Focal Length
25	Camera name
26	File Number / total files recorded
27	DATE
28	TIME
29	Histogram (Brightness)
30	Histogram (Red)
31	Histogram (Green)
32	Histogram (Blue)
33	Focusing Frame

*If these features are set, the icon will be displayed.

WHILE IN IMAGE INFO SCREEN:

- Press the  button again to return to the original Single-Image View.
- Different images can be selected in Single-Image View by pressing .



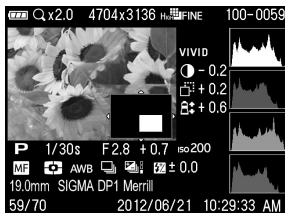

MAGNIFIED IMAGES IN IMAGE INFO SCREEN







While the Image Info Screen is displayed, it is possible to magnify the image by rotating the Command-Dial to the  direction. It is possible to obtain detailed histogram information for a particular section of an image.

- For more information on the histogram see the next section.

While magnifying the image in the Image Info Screen:

- Press the   buttons to pan to another part of the image. (Histogram will update automatically to reflect the new values.)
- Rotate the Command-Dial to the  position to increase magnification.
- Rotate the Command-Dial to the  position to decrease magnification.
- Press  to cancel magnification and view the Image Info Screen for full image.

CAUTION!!

- While magnifying an image, the  buttons cannot be used to change images. Rotate the Command-Dial to the  position or press the  button to return to the original ratio, then use the  buttons to change images.

HISTOGRAM

The histogram is a graph depicting the distribution of brightness values in the image for each of the three color channels (Red, Green, and Blue) (The histogram displayed in the Shooting Mode is the distribution of tones in the image). The horizontal axis shows the brightness level, with darker pixels towards the left side and brighter pixels toward the right. The vertical axis shows the proportion of pixels at each level of brightness.

By examining the histogram of the full image, you can gauge the overall exposure of that image. You can also use the histogram to determine if zoomed-in sections of an image are over or under exposed.

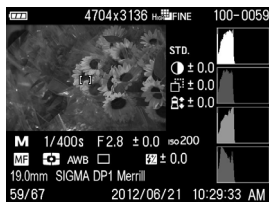

This histogram shows that the higher pixel values are never used in the image, indicating that the image is underexposed, and therefore will appear dark. In general, when the histogram is higher on the left side, the image is mostly composed of dark pixels, causing it to appear dark—either because the image is underexposed or because it is a dark scene such as night shot or sunset.

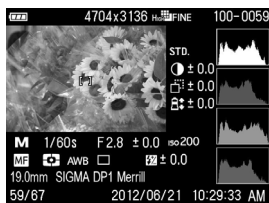

This histogram shows a fairly even distribution of pixel values, indicating that the image is well exposed, with good contrast. However, the histogram distribution of a well exposed image will vary greatly depending on the subject.



This histogram shows that many of the pixel values are at their brightness limit, indicating that some areas of the image may be blown out. In general, when the histogram runs off the right side, the image will have many white pixels—either because the image is overexposed or because it is a bright scene such as the beach or snow.

VIEWING IMAGES ON A TV

The DP1 Merrill camera can be connected to a television or a video/DVD recorder using the provided AV cable, allowing the recorded images to be viewed on the television monitor or recorded on videotape/DVD.

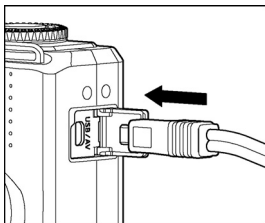

TO CONNECT THE CAMERA TO A VIDEO DEVICE

1

Open the USB / AV cover.

2

Connect the AV cable to the <USB / AV> terminal on the camera body.

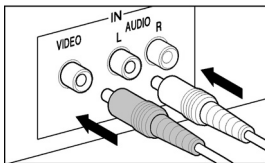

3

Connect the yellow AV cable plug into the video input terminal and the white plug into the audio terminal of the TV

4

Turn on the camera and video device.

WARNING !!

- Please do not use any video cable other than the one provided with your Sigma DP1 Merrill camera. Using other brands may cause damage.

TIP

- It is recommended that the camera be powered with the AC adapter (optional) during television playback to avoid draining the battery.
- The default mode for the video signal is NTSC. When connecting the camera to a PAL device, the Video Mode setting in the Camera Set-up menu must be changed. (See P.121,122)

DELETING FILES

This section describes how to delete the files recorded on a card.

WARNING !!

- In this chapter, "file" refers to still image and movie.

DELETE A FILE WITH THE DELETE BUTTON

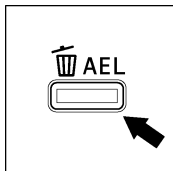

A single file that is displaying can be deleted by pressing the  button.





1

Select the file that you wish to delete.

2

Press the  and a confirmation dialog [**Delete current file?**] will be displayed.

3

To delete the file, select [**Yes**] by using the  buttons and press the  button. If you don't delete the file, select [**No**] by using the  buttons and press the  button.

WARNING !!

- If the file is locked, a confirmation dialog [**This file is locked.**] will come up and protect from deletion. If you wish to delete the file, it is necessary to unlock it first. (See **P.93-95** for information on locking and unlocking files.)
- Images stored as **RAW+JPG**, both the RAW and JPEG files will be deleted.

DELETE FILES FROM THE DELETE MENU

It is possible to delete a single file or multiple file from the Delete menu.

1

Press the **MENU** button and open [**▶**] **Playback Menu**] (P.28) to select [**Delete**].

2

Select from the following options from the sub-menu.

Current File	Delete the currently selected file only.
All Marked *	Delete all marked images on the card. (See P.96-98 for information on marking images.)
All *	Delete all files on the card. (Locked files are not deleted) (See P.93-95 for information on locking files.)

* It can be activated without viewing images.

3

Press the **OK** or **▶** button to confirm your selection. A confirmation dialog will appear.

4

Select [**Yes**] by using the **◀▶** buttons and press the **OK** button to apply the setting. If you want to cancel to apply the setting, select [**No**] by using the **◀▶** buttons and press the **OK** button.

TIP

- Marked images that are also locked will not be deleted with the [**All Marked**] menu item. The locked images must be unlocked first. Marked images are not protected from deletion unless they are also locked.

WARNING !!

- When [**All Marked**] or [**All**] is done, it may take time to finish them depending on the number of files in the card.

OTHER REVIEWING FEATURES

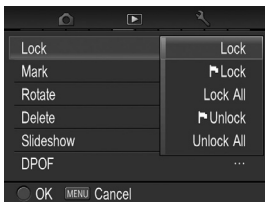

This section explains how to use Slideshow, Lock, Mark, Rotate and so on.

LOCKING FILES



Locking protects files from being accidentally deleted. Locked files must be unlocked before they can be deleted by the Delete Menu functions.

LOCK MENU

Lock/Unlock	Lock the currently selected file only. If the file is already locked, the menu item changes to "Unlock".
 Lock	Lock all marked images on the card. (See P.96-98 for information on marking images.)
Lock All	Lock all files on the card.
 Unlock	Unlock all marked images on the card. (See P.96-98 for information on marking images.)
Unlock All	Unlock all locked files on the card.

CAUTION !!

- Locking does not prevent files from being erased when the card is formatted. Review card contents carefully before formatting.

TIP

- Locked files have a “read-only” status when viewed on a computer.

TO LOCK A SINGLE FILE

1

Display the file that you wish to lock.

2

Press the **MENU** button and open [**▶**] **Playback Menu**] (P.28) to select [**Lock**]. ([**Lock**] in the sub-menu is already selected.)

3

Press the **OK** button or **▶** button.



- A key icon  will appear in the file indicating that the file is locked.

TIP

- To unlock a locked file, select the locked file and follow the same steps as above.

TO LOCK MULTIPLE FILES



1

Press the **MENU** button and open [ **Playback Menu**] (P.28) to select [**Lock**].







2

Select [ **Lock**] or [**Lock All**] from the sub-menu.

3



A confirmation dialog will be displayed by pressing the  or  button.

4



Select [**Yes**] by using the   buttons and press the  button to apply the setting. If you want to cancel to apply the setting, select [**No**] by using the   buttons and press the  button.

- A key icon  will appear in all locked files.

TIP

- To unlock multiple files, select the [**Unlock All**] or [ **Unlock**] in the Lock Menu.
- The  button can be used as a shortcut key for locking files. (See P.100)
- It is possible to lock and unlock multiple files when the images are not displayed.

WARNING !!

- When [ **Lock**] or [ **Unlock**] is done, it may take time to complete this depending on the number of files in the card.

MARKING IMAGES

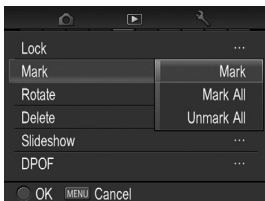

Images can be marked for various reasons, such as to identify favorites, to select images for a Slideshow, or to select images to be deleted with the “All marked” menu item in the Delete Menu (P.96-98).

MARK MENU

Mark/Unmark	Mark the currently selected image only. If the image is already marked, the menu item changes to “Unmark”.
Mark All	Mark all images on the card.
Unmark All	Unmark all marked images on the card.

TIP

- Images marked on the camera will retain their marked status when viewed in **SIGMA Photo Pro**.

WARNING !!

- It is not possible to mark movie files.

TO MARK A SINGLE IMAGE

1

Display the image that you wish to mark.

2

Press the **MENU** button and open [**▶** **Playback Menu**] (P.28) to select [**Mark**]. ([**Mark**] in the sub-menu is already selected.)

3

Press the **OK** or **▶** button.



- A flag icon  will appear in the image indicating that the image is marked.

TIP

- To unmark a marked image, select the marked image and follow the same steps as above.
- The **OK** button can be used as a shortcut key for marking images. (See **P.100**)

MARKING ALL IMAGES

1

Press the **MENU** button while displaying an image and open [**▶ Playback Menu**] (**P.28**) to select [**Mark**].

2

Select [**Mark All**] from the sub-menu.

3

A confirmation dialog will be displayed by pressing the **OK** or **▶** button.

4

Select [**Yes**] by using the **◀▶** buttons to and press the **OK** button to apply the setting. If you want to cancel to apply the setting, please select [**No**] by using the **◀▶** buttons to and press the **OK** button.

- A flag icon  will appear in all marked images.

TIP

- Select [**Unmark All**] from the Mark Menu to unmark all marked images on the card.
- [**Mark All**] and [**Unmark All**] can be applied when the images are not displayed.

WARNING !!

- When [**Mark All**] or [**Unmark All**] is done, it may take much time to finish them depending on the number of files in the card.

ROTATING IMAGES

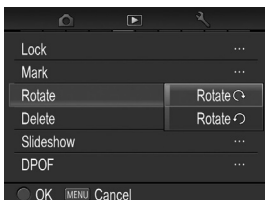

It is possible to rotate the displayed image.

ROTATE MENU

Rotate ⤴	Rotate the currently selected image 90 degrees to the right (clockwise).
Rotate ⤵	Rotate the currently selected image 90 degrees to the left (counterclockwise).

1

Display the image that you wish to rotate.

2

Press the **MENU** button to open [**▶ Playback Menu**] (P.28), and select [**Rotate**].

3

Select the rotation direction: [Rotate ↺] or [Rotate ↻] in the sub-menu.

4

Press the **OK** button or **▶** button.

TIP

- To rotate an image 180 degrees, rotate it twice in the same direction.
- To get an image back into its original orientation, rotate it in the opposite direction.
- The **OK** button can be used as a shortcut key for rotating images. (See **P.100**)
- Images rotated on the camera will be displayed in their rotated orientation in **SIGMA Photo Pro**.

WARNING !!

- When [Applied Rotate] in [▶ Playback Menu] (P.28) is set to [Off], it is not possible to select the Rotate Menu.

EXPOSURE WARNING



It is possible to indicate the over-exposed areas by highlighting them in red.

Set to [On] from [▶ Playback Menu] (P.28) → [Exposure Warning].

- The Exposure Warning is not indicated in the Quick Preview.









To dismiss the Exposure Warning, set to [Off] from [▶ Playback Menu] (P.28) → [Exposure Warning].

OK BUTTON SHORTCUT

It is possible to allocate a function from the Playback Menu to the  button. The allocated function can be changed by pressing the  button.

The OK Button Shortcut can be set in [ **Playback Menu**] (P.28) → [**OK Shortcut**].

Available functions to allocate to the button.

Lock/Unlock	Lock the currently selected image by pressing the  button. If the current image is already locked, the image will be unlocked.
Mark/Unmark	Mark the currently selected image by pressing the  button. If the current image is already marked, the image will be unmarked.
Rotate 	Each time the  button is pressed, rotate the currently selected image 90 degrees to the right (clockwise).
Rotate 	Each time the  button is pressed, rotate the currently selected image 90 degrees to the left (counterclockwise).
Exposure Warning	Each time the  button is pressed, toggle the exposure warning on or off.
Image Magnification	Each time the  button is pressed, toggle between zoomed-in view (10x) and original ratio.

To dismiss the allocated function, set to [**None**] from [ **Playback Menu**] (P.28) → [**OK Shortcut**].

RECORDING SOUND MEMO

It is possible to record a sound memo for 30 seconds to a stored image, making it convenient to record the shooting situation by voice.

1

Set to [On] from [▶] **Playback Menu**] (P.28) → [Sound Memo].

2

Close [▶] **Playback Menu**] by pressing the **MENU** button.

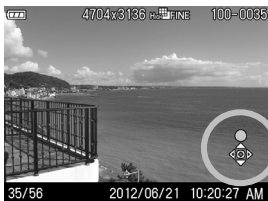

3

Press the ▲ button to start the recording.

- If the ▼ button is pressed during the recording, the recording will be terminated.
- Recording will be terminated automatically when 30 seconds has passed.



To play the recording sound memo, press the ▼ button. (See P.102 for instruction of Viewing Images With Sound.)

WARNING !!

- The sound memo function will not be disabled if it is not cancelled. Pressing the ▲ button will activate it each time and a new sound file will overwrite the existing file. To prevent this, please press [Off] after completing the “recording sound memo” function.

WARNING !!

- It is not possible to record sound memo if the card has little capacity.

VIEWING IMAGES WITH SOUND



1

When the image with sound is selected during image review, the  icon and the Control Icons are displayed on the color LCD monitor.

2

Press the  button to play the recorded sound.

Press the  button again to stop the sound.

WARNING !!

- It is not possible to play the recorded sound when the camera is in Zoomed-In View or Contact Sheet.

TIP

- If you want to change the volume of the recorded sound, it is possible to change the setting from [ **Camera Settings**] (P.28) → [**Sound Settings**] → [**Playback Volume**]. Please see [**Sound Settings**] in P.115 for more information.
- The sound recording (.WAV file) that is attached to the still image will be stored in the same folder and have the same file name as the image file. For example, the image file name will be SDIM0010.JPG and sound file name will be SDIM0010.WAV. When reviewing the files with your PC it is not possible to open still image and sound image at same time. Please open "WAV" file with dedicated software.

SHOWING A SLIDESHOW

All images on the card, or only selected images, can be shown in an automatic playback mode using the DP1 Merrill camera's Slideshow feature.

SLIDESHOW MENU

All Images	Start an automated slideshow of all images on the card.
Locked Images	Start an automated slideshow of all locked images on the card.
Marked Images	Start an automated slideshow of all marked images on the card.
Slideshow Settings	It is possible to set the length of time that each picture will be displayed and the availability of Repeat.

WARNING !!

- When viewing a slideshow, only first frame of a movie file will be displayed.

TO START A SLIDESHOW

1

Press the **MENU** button while displaying an image and open [**▶ Playback Menu**] (P.28) to select [**Slideshow**].

2

Select [**All Images**], [**Locked Images**] or [**Marked Images**] in the sub-menu.

3

The Slideshow starts by pressing the **OK** or **▶** button.

To terminate the slideshow, press the **OK** button.

WARNING !!

- When [**Marked Images**] is selected, it may take time to start the Slideshow depending on the number of files to be displayed.

CHAGING SLIDESHOW SETTINGS

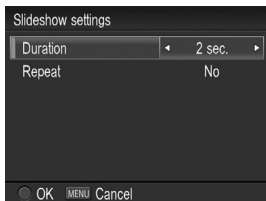

Select the **[Slideshow Settings]** in Slideshow Menu and then press the **OK** or **▶** button to open the setting display.

SLIDESHOW SETTING MENU

Duration	2 sec. 5 sec. 10 sec.	Set the length of time that each image in a slideshow is displayed.
Repeat	No Yes	Set whether the slideshow loops continuously or stops on the last image.

Duration

Select **[Duration]** using the **◆** buttons, then select the desired number of seconds by pressing the **◀▶** buttons.

Repeat

Select **[Repeat]** using the **◆** buttons, then select **[No]** or **[Yes]** by pressing the **◀▶** buttons.

Press **OK** button to confirm the Slideshow settings or **MENU** button to close the confirmation dialog without any change.

DPOF (DIGITAL PRINT ORDER FORMAT)

When printing images at a photo lab, it is possible to specify which photos and quantity to print in advance, using the DPOF menu. This is also available when making prints using a DPOF compatible printer.

WARNING !!

- In the case of RAW images (files with X3F extension), DPOF printing is not possible.

1

Press the **MENU** button to select [**DPOF**] in [**▶ Playback Menu**] (P.28) while displaying an image.

2

Select the desired option using the **OK** or **▶** button.

DPOF MENU

Select / Quantity	Set the print quantity by pressing the ◆ buttons. To set number of copies from multiple images, select the image that you wish to print by pressing the ◀▶ buttons and then set the print quantity for each image by pressing the ◆ buttons. Press the OK button to apply the setting.
Select All Images	This option selects all still images on the card for printing. Set print quantity by pressing the ◆ buttons and press the OK button to apply the setting.
Cancel All Selections	Reset all print quantity settings. Press the OK button to cancel all print quantity settings.

RECORDING AND PLAYING BACK MOVIES

RECORDING MOVIES

It is possible to record movies with sound.

- The image size is VGA (640X480) (Image area is 640X426, black stripes is recorded down).
- The number of shooting frames per second (frame rate) is 30 frames.
- The movie will be stored as an AVI file. (For instance, file number 0023 will be SDIM0023.AVI.)



Available recording time counter

Elapsed time counter

1



Set the Mode Dial to the  position.

2

Press the shutter button to start recording the movie. (During recording, the  icon and the busy lamp will blink.)

3

To terminate recording, press the shutter button again.

- When the focus mode is set to AF, the focus will be locked by pressing the shutter button “half-way”. During movie recording, the focus will remain locked.
- When the focus mode is set to MF, the focus will be locked to the position set by the Focus ring when pressing the shutter button. During movie recording, the focus will remain locked, even if the Focus ring is rotated.
- It is not possible to change the following settings in the Functions for shooting, [ Capture Settings] and [ Camera Settings] in Movie Mode.

Functions for shooting

Quick Set Menu (P.35)	MF Enlarged Display (P.54)
-----------------------	----------------------------

Capture Settings

ISO Sensitivity (P.62) ISO Sensitivity Step (P.64) Auto Bracketing (P.71) Drive Mode (P.55) Image Quality (P.66)	Image Size (P.65) Color space (P.66) Auto Rotate (P.75) Quick Preview (P.82)
--	---

Camera Settings

Custom Mode Setting (P.76)	Custom QS (P.37)
----------------------------	------------------

- The recording capacity of cards is as shown below.

1GB	2GB	4GB	8GB
10 min	20 min	40 min	80 min

WARNING !!

- The camera’s operation sound might be recorded while shooting the movie.
- The available recording time is dependent on the size of the SD card used. It is also possible that recording might be terminated during shooting due to the capacity of the card in use.
- The maximum recording data size for one movie shoot is 2GB. The recording will be terminated automatically when the recording data size exceeds 2GB.

WARNING !!

- The recording will be terminated when the battery power is insufficient.
- The remaining time display might not change constantly because it is calculated from the capacity of the card while shooting.
- The remaining time display can show a maximum of 99 min. 59 sec. If a large capacity card is used, the remaining time counter will not change from 99:59 until the recording time is 99min: 59 sec. or less.
- Custom white balance cannot be captured in Movie Mode. If you wish to use custom white balance, please capture it in still image mode and then change the camera back to Movie Mode.

PLAYING BACK MOVIES

How to playback movies.

1

When movie playback is selected, the first one frame of the movie is displayed as a still picture. The control icons are displayed on the bottom right of the movie playback screen.

2

Press the ▼ button to playback the movie.

Movie playback screen



Recorded time

Elapsed playback time counter

Control Icons

Movie play back screen***

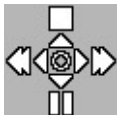

Press the ▲ button to terminate playback.

Press the ▼ button to pause playback.

Press the ► button to fast-forward.

(Each time the ► button is pressed, the fast-forward speed changes to 2x, 4x and 8x faster. By pressing the ◀ button, the speed slows down.)

Press the ◀ button to fast-rewind.

(Each time the ◀ button is pressed, the fast-rewind speed changes to 2x, 4x and 8x faster. By pressing the ► button, the speed slows down.)

When “pause” is selected***

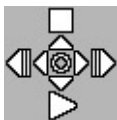

Press the ▲ button to terminate playback.

Press the ▼ button to restart playback.

Keep pressing the ► button to play in slow motion.

Keep pressing the ◀ button to rewind in slow motion.

TIP



- If you want to change the volume of the recorded sound, it is possible to change the setting from [**Camera Settings**] (P.28) → [**Sound Settings**] → [**Playback Volume**]. Please see [**Sound Settings**] in P.115 for more information.
- After transferring the files to your PC, please play AVI files with dedicated software.

CHANGING OTHER SETTINGS

This section explains how to change the setting of basic camera operation to your desired settings.

FILE NUMBERING SYSTEM

Stored data is automatically assigned file numbers from 0001 to 9999. When data is being reviewed, the file number of each image is displayed in the right corner on the color LCD monitor (see **P.84, 87**). The file number is also incorporated into the filename of the image. The filename consists of "SDIM" followed by the 4-digit file number and extension. For example: image number 0023 will be stored in the file SDIM0023.X3F. All DP1 Merrill image files will be stored to ###SIGMA folder of the DCIM folder in the card.

- When [**Adobe RGB**] is selected from [ **Shooting Menu**] (**P.28**) → [**Color space**], the filename will consist of "_SDI" instead of "SDIM".
- File numbering can be continuous, or can be reset every time an empty card is detected. The File Numbering can be set from [ **Camera Settings**] (**P.28**) → [**File Numbering**].

FILE NUMBERING OPTIONS

Continuous (Default)	Numbering is continuous. The first file number assigned on an empty card will be one higher than the last assigned number. (If the inserted card contains DP1 Merrill images with file numbers greater than the last assigned number, file numbering will continue with one higher than the highest file number on the card.)
Auto Reset	Each time an empty card is inserted, or all images on the current card are deleted, the file number will reset to its default value of 0001. (If the inserted card already contains DP1 Merrill images, the file number will not be reset).

WARNING !!

- When Folder numbering / File numbering is reached to "999-9999", even if the card has the capacity, the message of **[Card Full]** will be displayed and it is not possible to take pictures any more. Please check the File numbering in reviewing display. If the file number of "999-9999" exists in the card, please proceed as follow.
 1. Transfer all files in the card to your PC.
 2. Format the card.
 3. If the **[File Numbering]** is set to **[Continuous]**, once set to **[Auto Reset]**.
 4. If you usually set **[File numbering]** to **[Continuous]**, set to **[Continuous]** once again.
- If you wish to continue to take pictures with any other card, please proceed it from step 3.

CUSTOMIZING THE DIAL AND BUTTON

It is possible to customize the allocation and dial direction of the Command Dial and the ◀▶ buttons, and the dial direction of the Focus ring as follows in Exposure mode.

KEY ARRANGEMENT

The Command Dial and the ◀▶ button are used for changing the aperture value, shutter speed and exposure compensation. It is possible to change the function of them for each Exposure Mode.

It is possible to set from [📷 Capture Settings] (P.28) → [Key arrangement].

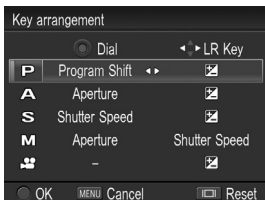

Select the desired Exposure Mode by pressing the ◀ button and change the function by using the ◀▶ button. To apply the setting, press the OK button.

- To reset to the default setting, please press the [📷] button and then press the OK button.

REVERSE DIAL DIRECTION SETTING





It is possible to reverse the Dial direction and Focus ring direction.

It is possible to set from [📷 Capture Settings] (P.28) → [Reverse Dial Direction Setting].





Select the option you want to change by using the ◀▶ buttons. Then select [Original] or [Reverse] and press the OK button to apply the setting.



Aperture / Shutter speed

	Aperture Value	Shutter Speed
Original (Default)	Open  Stop down	Slow  Fast
Reverse	Stop down  Open	Fast  Slow

Exposure compensation

	Exposure Compensation Value
Original (Default)	Under Expose  Over Expose
Reverse	Over Expose  Under Expose

Focus Ring

	Focus Position
Original (Default)	Close  Distant
Reverse	Distant  Close

WARNING !!

- It is not possible to reverse the direction of the ◀▶ buttons.

LCD OFF AND AUTO POWER OFF

The DP1 Merrill has [LCD Off] and [Auto Power Off] functions in order to conserve battery power. If not used for a predetermined amount of time, the color LCD monitor or power will be turned off automatically.

LCD Off

If not used for a predetermined amount of time, the backlight of the color LCD monitor will be turned off automatically. Although the color LCD monitor is turned off, the camera power remains ON, therefore, each button can be operated normally. It is possible to change to shooting mode, upon pressing the shutter button halfway.

Auto Power Off

If not used for a predetermined amount of time, the camera will be turned off automatically. While the camera is in Auto Power Off, each button will not function. It is necessary to press the Power switch to terminate Auto Power Off.

Set the Auto Power Off from [ Camera Settings] (P.28) → [LCD Off] and [Auto Power Off].

LCD Off Option

Off
 10 sec.
30 sec.
1 min. (Default)
5 min.
10 min.

Auto Power Off Option

Off
30 sec.
1 min.
5 min. (Default)
10 min.

-  icon is the recommended setting for conserving the electronic power.

TIP

- To disable LCD Off, set [LCD Off] to [Off].
- To disable Auto Power Off, set [Auto Power Off] to [Off].

WARNING !!

- It is not possible to set [LCD Off] for a longer time than [Auto Power Off]. For example, when [LCD Off] is set to [5 min.] and [Auto Power Off] is set to [1 min.], the [LCD Off] setting will be changed to [1 min.] automatically.

SOUND SETTINGS

This section explains settings about the Shutter Sound, Operation Sound, Sound Volume and Playback Volume.

These sound settings can be set from [📷 Capture Settings] (P.28) → [Sound Setting].

Shutter Sound

It is possible to set the Shutter Sound by setting to [On] or [Off].

- The default setting is [On].

Operation Sound

It is possible to set the Operation Sound when the focus is verified, alarm when the focus is not verified and operation sound of the self-timer by setting to [On] or [Off].

- The default setting is [On].

Sound Volume

It is possible to set the volume of Shutter Sound and Operation Sound from 0 to 5 in six levels. It is possible to down the volume by the ◀ button and up by the ▶ button.

- Setting of 0 does not make sound.
- The default setting is 3.

Playback Volume

It is possible to set the Playback Volume and Sound Memo volume from 0 to 5 in six levels. It is possible to reduce the volume by pressing the ◀ button and increase the volume by pressing the ▶ button.

- Setting of 0 does not make sound.
- The default setting is 3.

RESET TO THE DEFAULTS

It is possible to reset the settings to the defaults.

It is possible to reset settings to defaults from [ **Camera Settings**] (P.28) → [**Camera Reset**].

Reset all settings of [ **Capture Settings**] (Blue tab) to the defaults.

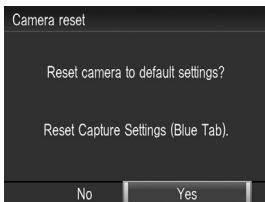

In [**Camera Reset**] menu, Select [**Yes**] by pressing the ◀▶ button and press the  button.

To cancel the reset settings, select [**NO**] by pressing the ◀▶ button and press the  button.

If you want to reset all the camera settings, including other settings, you will have to reset the camera to factory defaults. In [**Camera Reset**] menu, press  to show the message [**Reset all camera settings to factory defaults?**].

To reset all camera settings to factory defaults, please select [**Yes**] by pressing the ◀▶ buttons and press the  button.

To cancel the reset settings, select [**NO**] by pressing the ◀▶ buttons and press the  button.

CONNECTING TO A COMPUTER

CONNECTING YOUR CAMERA TO A COMPUTER

The DP1 Merrill camera can be connected directly to a computer using the provided USB cable. Make sure that the camera is off before connecting it to the computer. Data transfer rates will vary depending on the computer and operating system used. For further information, please refer to Help within **SIGMA Photo Pro**.

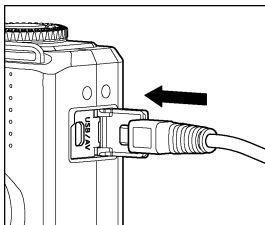

1

Turn the computer on.

2

Connect your camera to a computer with the provided USB cable.

WARNING!!

- Please ensure your computer is not in sleep mode whilst your camera connects to the computer. It may cause the data to be lost or damaged.
- Do not connect another USB cable to the computer while your camera is connecting to the computer. It may cause the data to be lost or damaged.
- Please use only the USB cable supplied with your camera.
- The shutter button and color LCD monitor will be disabled while the camera is connected to the computer via a USB cable.
- The Auto Power Off function does not work while connecting the USB cable.

REFERENCE

OPTIONAL ACCESSORIES

ELECTRONIC FLASH EF-140 DG SA-STTL

This compact design flashgun has a maximum Guide Number of 14 (ISO100 / m). Please see **P.78** for more information.

VIEW FINDER VF-11

This high performance Albada inversed Galilean type Finder mounts on the hot shoe. It offers a framing guide for deciding the composition without the color LCD monitor and accurate framing unaffected by external light condition.

LENS HOOD LH1-01

This lens hood blocks out extraneous light and reduces flare and ghosting. It can be attached to the tip of the lens easily.

AC ADAPTER SAC-5

This is used to provide a constant electricity supply and is recommended when taking indoor shots or connecting the camera to your computer to transfer data. (DC Connector CN-11 is included with this camera to connect the AC adapter to the computer.) (**P.23**)

MAINTENANCE

- Do not use chemicals or other cleaning agents such as thinners or benzene for cleaning the camera and lens. Use a clean, soft cloth and blower to clean the camera and lens. Lens cleaners can be used for removing fingerprints.
- Do not lubricate the camera.
- Use a blower to remove dust and dirt from the color LCD monitor. To remove fingerprints or other stains from the LCD monitor, wipe the surface gently with a soft, clean cloth. Do not apply excessive force, as this could damage the LCD monitor.

HOW TO STORE THE CAMERA

- If you intend to store the camera for a long time, remove the battery.
- To avoid growth of fungus, store the camera and lens in a dry, cool and ventilated place, with a drying agent such as silica gel. Keep your equipment away from chemicals.

NOTE ON THE TFT COLOR LCD MONITOR

- A few pixels may always be lit or may never light on the LCD monitor. This is not a failure or malfunction. Images recorded with the camera will not be affected.
- Because of the normal physical characteristics of the liquid crystal, the reaction of the display may become slow at low temperatures. At high temperatures, the display may become dark, but it will return to normal at room temperature.

EXPLANATION OF TERMS

AE

Auto Exposure; by using a built-in exposure meter, the camera determines the correct exposure value, which is a combination of shutter speed and aperture value.

AE Lock

The camera will fix and memorize the exposure value with AE lock. For example, if a photographic subject is placed in the center and exposure value of the composition is fixed, the brightness of the background will not influence the exposure, even if the composition changes and the subject is moved from the center of a screen. (AE lock button must be used).

AF

Auto Focus; by using a built-in sensor, camera adjusts the focusing automatically.

AF Lock

In AF shooting mode, you can lock the focus on the main subject. For instance, compose the desired subject in the center of the viewfinder. With the focus fixed at the same setting, you can re-compose the picture with the subject off-center and take pictures. (Please press the shutter button "Half-way" to use this feature with the Sigma DP1 Merrill).

Aperture

The lens opening of the iris diaphragm inside the lens. The amount of light, which strikes the image sensor, is adjusted by the iris diaphragm. The f-number (Focal Length/Diameter of the Aperture Opening) describes the size of this opening, the size of the hole can be made larger or smaller. A large aperture (low f-number) gives bright results and a small aperture (high f-number) gives darker results.

Auto Power-Off

To save battery power, the DP1 Merrill camera will automatically turn itself off if it is not used for a period of time.

CMOS

Complementary Metal Oxide Semiconductor (CMOS) can perform signal amplification on a per-pixel basis. Significant current flows only during the switching operation. Therefore a CMOS image sensor can scan data rapidly, sustain high-speed operation and consume less energy. Recent technological and production improvements in digital imaging systems are making CMOS more and more competitive in terms of image quality and cost.

Color Temperature

The numerical expression of the tone of the light, produced by a light source. The standard unit for color temperature is degrees Kelvin (K). The sunny daylight used as a standard near 5600 K. Low color temperature implies warmer more yellow/red light while high color temperature implies a colder more blue light. The typical color temperature of Tungsten light is 3200 K grade, a personal computer is 9300 K.

Exposure.

The amount of light reaching the image sensor's surface. The exposure is controlled by the combination of aperture and shutter speed.

EV

Exposure Value (EV) is a numerical value that expresses the amount of light for a given exposure, and depends on brightness of the photographic subject and sensitivity of the film. If a photographic subject is bright, then this numerical value will be large, and if the subject is dark then this numerical value will be small. If two-times of light reaches the film surface then the difference in exposure value will be +1, and if the amount of light is reduced by half, the exposure value changes by -1.

Histogram

The histogram function is a graphic representation of how bright and dark pixels are distributed in an image. The histogram function enables a precise check on the exposure of the photo.

ISO Sensitivity

ISO (International Organization for Standardization) ; refers to the number assigned to each silver halide film, which indicates film speed or the film's relative sensitivity to light, the higher the number, the greater photosensitivity and vice versa. Digital cameras also use standard ISO sensitivity ratings like silver halide films.

JPEG

Joint Photographic Experts Group has established a standard method for compressing and decompressing the digitized images. If the rate of compression is high the file size will be small but picture quality will be decreased.

NTSC

National Television Standards Committee (NTSC) video format is primarily used in the United States, Japan, Canada etc. The NTSC is a standard for television and videos, which defines a composite video signal with a refresh rate of 60 half-frames (interlaced) per second. Each frame contains 525 lines and can contain 16 million different colors.

PAL

Phase Alternating Line (PAL) video format, primarily used in Europe, excluding France, as well as Australia and parts of the Far East. PAL delivers 625 lines at 50 half-frames per second.

RAW

The RAW image format is the data as it comes directly from the image sensor of the camera. No in-camera processing is performed before transferring the image to computer.

Shutter Speed

The camera's shutter opens for a length of time to control the amount of light that reaches the imaging element. The length of time that shutter blinds are open allowing light to strike the image sensor is called a shutter speed.

White Balance

The human eye and brain adapt to changes in lighting conditions, not only to intensity, but also to the color characteristic of the light source, so that colors of the objects look normal or accurate. For example, a white object will appear white whether it is viewed under sunlight, tungsten or fluorescent illumination. However, color film or digital camera must be adjusted, so that colors will be represented accurately, under different types of illumination. This adjustment is called white balance. The function to adjust a white balance automatically is called automatic white balance.

TROUBLESHOOTING

If you have a problem with your camera or cannot take good pictures, consult the list below as you check the camera before requesting repairs.

Nothing is displayed on the color LCD monitor.

Battery is exhausted.

- ▶ Replace the battery. (P.18 - 22)

LCD Monitor is set to OFF mode.

- ▶ Press the  button to display the color LCD monitor. (P.38)

Camera is in LCD Off mode.

- ▶ Press the shutter button "half-way" or any other button. (P.114)

The shutter does not release.

The camera is busy writing to the card.

- ▶ Please wait until the card busy light goes off.

Card is full.

- ▶ Insert a new card or delete unwanted images. (P.91 - 93)

Autofocus does not operate.

Focusing mode is set to MF.

- ▶ Change the focusing mode by pressing the Focus mode button. (P.49)

The camera has turned off automatically.

Auto Power Off is activated.

- ▶ The Auto Power Off function is set in order to conserve battery power. If it is inconvenient, please set the Auto Power Off to "Off". (P.114)

Cannot shoot or store images.

Card is full

- ▶ Insert a new card or delete unwanted images. (P.91 - 93)

Battery is exhausted.

- ▶ Replace the battery. (P.18 - 22)

The write protection switch is in the 'LOCK' position.

- ▶ Please unlock the write protection switch on the card. (P.10)

Image data on the card is corrupted.

- ▶ If important data remains in the card after transferring it to your PC, please format the card. (P.42)

Difficulty seeing the images on the color LCD monitor.

Dust or dirt has adhered to the color LCD monitor.

- ▶ Clean the color LCD monitor with a blower or eyeglass cloth. (P.119)

The color LCD monitor is worn out.

- ▶ Please consult the retailer from which you purchased the camera or contact the nearest Sigma Service Center.

Pictures are coming out blurred

AF may not be activated when the shutter was pressed.

- ▶ Press the shutter button “half-way” and press it after the focusing point is illuminated in green. (P.49)

Focusing mode is set to MF.

- ▶ Change the focusing mode by pressing the Focus mode button. (P.49)

Camera shake is occurred.

- ▶ Use the flashguns or tripod. (P.78)

Cannot delete images.

Images may be locked.

- ▶ Unlock the images. (P.93 - 95)

The write protection switch is in the ‘LOCK’ position.

- ▶ Please unlock the write protection switch on the card. (P.10)

Incorrect date and time is shown.

Date and time setting may be incorrect.

- ▶ Enter the correct date and time in the Set-up Menu. (P.27)

No image appears on the TV monitor.

The AV cable is not connected properly.

- ▶ Reconnect the AV cable.

The video terminal (yellow) and the audio terminal (white) are not connected properly.

- ▶ Reconnect the video terminal (yellow) and audio terminal (white) to the correct position. (P.90)

Cannot play-back sound

Sound volume is set 0.

- ▶ The Sound Volume can be set from [ **Camera Settings**] (P.28)
→ [**Sound Settings**] → [**Sound Volume**]. (P.115)

SPECIFICATIONS

Image Sensor	FOVEON X3 Direct Image Sensor (CMOS)	
Image Sensor Size	23.5 × 15.7mm	
Color Photo Detectors	Total Pixels : 48MP Effective Pixels : 46MP (4,800×3,200×3 layers)	
Aspect Ratio	3 : 2	
Lens	19mm (35mm equivalent focal length : 28mm)	
Lens F number	F2.8 ~ F16	
Lens Construction	8 Groups, 9 Elements	
Shooting Range	20 cm ~ ∞, 1m ~ ∞ (LIMIT mode)	
Filter Size	49mm	
Storage Media	SD Card, SDHC Card, SDXC Card, Multi Media Card	
Recording Format	Exif 2.3, DCF 2.0, DPOF	
File Format	Still image	Lossless compression RAW Data (12-bit) JPEG (High, Medium, Low) RAW+JPEG
	Movie	AVI
Image size (Number of Pixels)	Still image	HIGH : 4704 x 3136 MED : 3264 x 2176 LOW : 2336 x 1568
	Movie	VGA : 640×480 (Image area 640×426)
Image Quality (Still Image)	RAW, JPEG (Fine, Normal, Basic), RAW+JPEG(Fine)	
White Balance	8 types (Auto, Daylight, Shade, Overcast, Incandescent, Fluorescent, Flash, Custom)	
Color Mode	7 types (Standard, Vivid, Neutral, Portrait, Landscape, B&W*, Sepia*) * Only JPEG mode	
ISO Sensitivity	ISO 100 ~ ISO 6400 (1/3 steps for appropriate sensitivity) AUTO: High limit, low limit setting is possible between ISO 100 ~ ISO 6400. When using with flash, it changes depending on the low limit setting.	
Auto Focus	Contrast Detection Type	
AF Point	9 points select mode, Free move mode (It is possible to change the size of Focus Frame to Spot, Regular and Large.)	

Focus Lock	Shutter release halfway-down position (AF lock can be done by AE lock button from menu setting)
Manual Focus	Focus Ring type
Metering System	Evaluative metering, Center-Weighted Average Metering Spot metering
Exposure Control System	(P) Program AE, (S) Shutter Priority AE, (A) Aperture Priority AE, (M) Manual
Exposure Compensation	±3EV (1/3 stop increments)
AE Lock	AE lock button
Auto Bracketing	Appropriate, under, over; 1/3EV steps up to ±3EV for appropriate exposure
Shutter Speed	1/2000* - 30sec. (*Depending on the aperture value, shutter speed changes)
Flash Mode	Forced Flash, Red-Eye Reduction Flash, Slow Synchro Mode
External Flash Sync.	Hotshoe (X Sync. Contact)
Drive Modes	Single, Continuous, Self Timer (2sec. /10sec.) Interval timer, Infinite Shooting
LCD Monitor	approx. 920,000 pixels, 3.0 inches TFT color LCD monitor
LCD Monitor Language	English / Japanese / German / French / Spanish / Italian / Simplified Chinese / Traditional Chinese / Korean / Russian / Dutch / Polish / Portuguese / Danish / Swedish / Norwegian / Finnish
Interface	USB (USB2.0), Video Out (NTSC/PAL), Audio Out (Monaural)
Power	Li-ion Battery BP-41, AC Adapter SAC-5 (with DC Connector CN-11) (Optional)
Battery Life	Approx. 97 (+25°C)
Dimensions	121.5mm/4.8" (W) × 66.7mm /2.6"(H) × 64.3mm/2.5"(D)
Weight	360g / 12.7oz (without battery and card)

This device complies with Part 15 of the FCC Rules. Operation is subject to the following two conditions:
(1) This device may not cause harmful interference, and
(2) this device must accept any interference received, including interference that may cause undesired operation.

SIGMA DP1 Merrill
FC Tested To Comply
With FCC Standards
FOR HOME OR OFFICE USE

SIGMA CORPORATION OF AMERICA
15 Fleetwood Court, Ronkonkoma,
NY 11779, U.S.A.
TEL: 631 585 1144

For customers in the U.S.A.

Federal Communications Commission (FCC) Radio Frequency Interference Statement

This equipment has been tested and found to comply with the limits for class B digital devices, pursuant to Part 15 of the FCC Rules. These limits are designed to provide reasonable protection against harmful interference in a residential installation. This equipment generates, uses and can radiate radio frequency energy and, if not installed and used in accordance with the instructions, may cause harmful interference to radio communications. However, there is no guarantee that interference will not occur in a particular installation. If this equipment does cause harmful interference to radio or television reception, which can be determined by turning the equipment off and on, the user is encouraged to try to correct the interference by one or more of the following measures:

- Reorient or relocate the receiving antenna.
- Increase the separation between the equipment and receiver.
- Connect the equipment into an outlet on a circuit different from that to which the receiver is connected.
- Consult the dealer or an experienced radio/TV technician for help.

Use of interface cable is required to comply with class B limits in Subpart B of Part 15 of FCC Rules.

Any changes or modifications to this equipment not specified in this manual may void your warranty.

For customers in the Canada

This Class B digital apparatus complies with Canadian ICES-003.

Cet appareil numérique de la classe B est conforme à la norme NMB-003 du Canada.



The CE Mark is a Directive conformity mark of the European Community (EC).

SIGMA (Deutschland) GmbH

Carl-Zeiss-Str. 10/2, D-63322 Roedermark, Germany

Verkauf: 01805-90 90 85-0 Service: 01805-90 90 85-85 Fax(Service): 01805-90 90 85-35

SIGMA CORPORATION

2-4-16 Kurigi, Asao-ku, Kawasaki-shi, Kanagawa 215-8530 Japan

Phone : 044 - 989 - 7430 Fax : 044 - 989 - 7451