



COLOUR VIDEO COPY PROCESSOR

MODEL

CP900E

OPERATION MANUAL

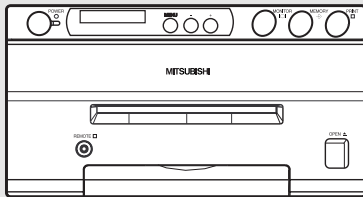

THIS OPERATION MANUAL IS IMPORTANT  
TO YOU.  
PLEASE READ IT BEFORE USING YOUR  
COLOUR VIDEO COPY PROCESSOR.

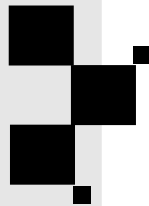

# COLOUR VIDEO COPY PROCESSOR

This colour video copy processor complies with the requirements of the EC Directive 89/336/EEC, 73/23/EEC, 93/42/EEC and 93/68/EEC.

The electro-magnetic susceptibility has been chosen at a level that gains proper operation in residential areas, on business and light industrial premises and on small-scale enterprises, inside as well as outside of the buildings. All places of operation are characterised by their connection to the public low voltage power supply system.

# CAUTION:

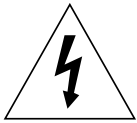

**RISK OF ELECTRIC SHOCK DO NOT OPEN.**



TO REDUCE THE RISK OF ELECTRIC SHOCK, DO NOT REMOVE COVER (OR BACK)

NO USER-SERVICEABLE PARTS INSIDE. REFER SERVICING TO QUALIFIED SERVICE PERSONNEL.

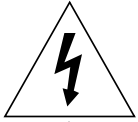

The lightning flash with arrowhead symbol, within an equilateral triangle, is intended to alert the user to the presence of uninsulated "dangerous voltage" within the product's enclosure that may be of sufficient magnitude to constitute a risk of electric shock.



The exclamation point within an equilateral triangle is intended to alert the user to the presence of important operating and maintenance (servicing) instructions in the literature accompanying the appliance.

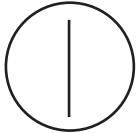

The "ON/OFF" symbol indicates connection to or disconnection from the mains, at least for mains switches.

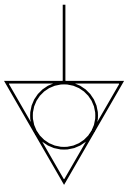

The "Equipotentiality" symbol identifies the terminals connected each other. The potential of various parts of equipment or of a system is equalized.



The "Alternating current" symbol indicates that the equipment is suitable for alternating current only.

When you dispose of the unit or accessories, you must obey the law in the relative area or country and/or regulation in the relative hospital.

## **WARNING:**

Install and use this appliance in accordance with the operation manual for safety and EMC (Electromagnetic Compatibility). If it is not installed and used in accordance with the operation manual, it may cause interference to other equipment and/or other risk.

To prevent fire or shock hazard, do not expose this appliance to rain or moisture.

This appliance must be earthed.

In Europe, use the AC power cord according to the recommendations as below, in order to comply with EN60601-1 and EN60950-1.

Connect to the 230V receptacle of the room or the host equipment.

The AC power cord should be VDE approved and consist of core size 1mm<sup>2</sup> or bigger, length 2.5m or shorter cord with IEC60320-1/C13 type, 250V 10A or higher rating connector and CEE(7)VII type, 250V 10A or higher rating plug.

Use the video cable, S-video cable, and/or the wired remote control according to the recommendations as below, in order to comply with safety and EMC standards.

The video cable shall be 2m long or shorter, 75Ω coaxial, 3C-2VT or equivalent one, with BNC plug at each end.

The S-video cable shall be Mitsubishi Electric model JC-44S (1.5 m long or shorter, shielded wire) or equivalent one, with DIN 4P plug at each end.

The wired remote control shall be Mitsubishi Electric parts No. 290P051010. (2m long or shorter, shielded wire, with 3.5mm diameter stereo mini-plug and switch box.)

This product is to be employed with medical equipment, just for reference purpose, not for medical diagnostic purpose.

# INSTRUCTIONS FOR MEDICAL USE

<according to the Medical Safety/EMC standard IEC/EN 60601-1-2>

MEDICAL ELECTRICAL EQUIPMENT needs special precautions regarding EMC and needs to be installed and put into service according to the EMC information provided in the ACCOMPANYING DOCUMENTS.

Portable and mobile RF communications equipment can affect MEDICAL ELECTRICAL EQUIPMENT.

Technical description

List of all cables and maximum length of the cable and transducers and other ACCESSORIES

	Maximum length	Reference page in this operation manual
AC power cord	2.5 m	This page, the previous pages for safety and page 59 for accessories
Video cable	2 m	This page, the previous pages for safety and page 59 for accessories
S-video cable	1.5 m	This page, the previous pages for safety and page 59 for accessories
Wired remote control	2 m	This page, the previous pages for safety and page 59 for accessories
Print paper		Page 5 and 21 for print paper, Page 59 for accessories

## WARNING:

The use of ACCESSORIES, transducers and cables other than those specified, with the exception of transducers and cables sold by the manufacturer of the Model CP900E as replacement parts for internal components, may result in increased EMISSIONS or decreased IMMUNITY of the Model CP900E.

## WARNING:

The Model CP900E should not be used adjacent to or stacked with other equipment and that if adjacent or stacked use is necessary, the Model CP900E should be observed to verify normal operation in the configuration in which it will be used.

Guidance and manufacturer's declaration - electromagnetic emissions		
The Model CP900E is intended for use in the electromagnetic environment specified below. The customer or user of the Model CP900E should assure that it is used in such an environment.		
Emission test	Compliance	Electromagnetic environment - guidance
RF emissions CISPR 11/EN 55011	Group 1	The Model CP900E uses RF energy only for its internal function. Therefore, its RF emissions are very low and are not likely to cause interference in nearby electronic equipment.
RF emissions CISPR 11/EN 55011	Class B	
Harmonic emissions IEC/EN 61000-3-2	Class A	
Voltage fluctuations / flicker emissions IEC/EN 61000-3-3	Complies	The Model CP900E is suitable for use in all establishments, including domestic establishments and those directly connected to public low-voltage power supply network that supplies buildings used for domestic purpose.

Guidance and manufacturer's declaration - electromagnetic immunity			
The Model CP900E is intended for use in the electromagnetic environment specified below. The customer or user of the Model CP900E should assure that it is used in such an environment.			
Immunity test	IEC/EN 60601 test level	Compliance level	Electromagnetic environment - guidance
Electrostatic discharge (ESD) IEC/EN 61000-4-2	±6 kV contact ±8 kV air	±6 kV contact ±8 kV air	Floors should be wood, concrete or ceramic tile. If floors are covered with synthetic material, the relative humidity should be at least 30%.
Electrical fast transient/burst IEC/EN 61000-4-4	±2 kV for power supply lines ±1 kV for input /output lines	±2 kV for power supply lines ±1 kV for input /output lines	Mains power quality should be that of a typical commercial or hospital environment.
Surge IEC/EN 61000-4-5	±1 kV differential mode ±2 kV common mode	±1 kV differential mode ±2 kV common mode	Mains power quality should be that of a typical commercial or hospital environment.
Voltage dips, short interruptions and voltage variations on power supply input lines IEC/EN 61000-4-11	< 5% $U_T$ (> 95% dip in $U_T$ ) for 0.5 cycle 40% $U_T$ (60% dip in $U_T$ ) for 5 cycles 70% $U_T$ (30% dip in $U_T$ ) for 25 cycles < 5% $U_T$ (> 95% dip in $U_T$ ) for 5 sec.	< 5% $U_T$ (> 95% dip in $U_T$ ) for 0.5 cycle 40% $U_T$ (60% dip in $U_T$ ) for 5 cycles 70% $U_T$ (30% dip in $U_T$ ) for 25 cycles < 5% $U_T$ (> 95% dip in $U_T$ ) for 5 sec.	Mains power quality should be that of a typical commercial or hospital environment. If the user of the Model CP900E requires continued operation during power mains interruptions, it is recommended that the Model CP900E be powered from an uninterruptible power supply or a battery.
Power frequency (50/60 Hz) magnetic field IEC/EN 61000-4-8	3 A/m	3 A/m	Power frequency magnetic fields should be at levels characteristic of a typical commercial or hospital environment.
NOTE $U_T$ is the a.c. mains voltage prior to application of the test level.			

Guidance and manufacturer's declaration - electromagnetic immunity

The Model CP900E is intended for use in the electromagnetic environment specified below. The customer or user of the Model CP900E should assure that it is used in such an environment.

Immunity test	IEC/EN 60601 test level	Compliance level	Electromagnetic environment - guidance
<p>Conducted RF IEC/EN 61000-4-6</p> <p>Radiated RF IEC/EN 61000-4-3</p>	<p>3 Vrms 150 kHz to 80 MHz</p> <p>3 V/m 80 MHz to 2,5 GHz</p>	<p>3 Vrms</p> <p>3 V/m</p>	<p>Portable and mobile RF communications equipment should be used no closer to any part of the Model CP900E, including cables, than the recommended separation distance calculated from the equation applicable to frequency of the transmitter.</p> <p>Recommended separation distance <math>d=1.2\sqrt{P}</math></p> <p><math>d=1.2\sqrt{P}</math> 80 MHz to 800 MHz <math>d=2.3\sqrt{P}</math> 800 MHz to 2.5 GHz</p> <p>where P is the maximum output power rating of the transmitter in watts (W) according to the transmitter manufacturer and d is the recommended separation distance in meters (m).</p> <p>Field strengths from fixed RF transmitters, as determined by an electromagnetic site survey,<sup>a</sup> should be less than the compliance level in each frequency range.<sup>b</sup></p> <p>Interference may occur in the vicinity of equipment marked with the following symbol:</p> 

NOTE1. At 80 MHz and 800 MHz, the higher frequency range applies.  
 NOTE2. These guidelines may not apply in all situations. Electromagnetic propagation is affected by absorption and reflection from structures, objects and people.

<sup>a</sup> Field strengths from fixed transmitters, such as base stations for radio (cellular/cordless) telephones and land mobile radios, amateur radio, AM and FM radio broadcast and TV broadcast cannot be predicted theoretically with accuracy. To assess the electromagnetic environment due to fixed RF transmitters, an electromagnetic site survey should be considered. If the measured field strength in the location in which the Model CP900E is used exceeds the applicable RF compliance level above, the Model CP900E should be observed to verify normal operation. If abnormal performance is observed, additional measures may be necessary, such as reorienting or relocating the Model CP900E.

<sup>b</sup> Over the frequency range 150 kHz to 80 MHz, field strength should be less than 3 V/m.

Recommended separation distances between  
Portable and mobile RF communications equipment and the Model CP900E

The Model CP900E is intended for use in the electromagnetic environment in which radiated RF disturbances are controlled. The customer or user of the Model CP900E can help prevent electromagnetic interference by maintaining a minimum distance between portable and mobile RF communications equipment (transmitters) and the Model CP900E as recommended below, according to the maximum output power of the communications equipment.

Rated maximum output power of transmitter W	Separation distance according to frequency of transmitter m		
	150 kHz to 80 MHz $d=1.2\sqrt{P}$	80 MHz to 800 MHz $d=1.2\sqrt{P}$	800 MHz to 2.5 GHz $d=2.3\sqrt{P}$
0.01	0.12	0.12	0.23
0.1	0.38	0.38	0.73
1	1.2	1.2	2.3
10	3.8	3.8	7.3
100	12	12	23

For transmitters rated at maximum output power not listed above, the recommended separation distance  $d$  in meters (m) can be estimated using the equation applicable to the frequency of the transmitter, where  $P$  is the maximum output power rating of the transmitter in watts (W) according to the transmitter manufacturer.

NOTE1. At 80 MHz and 800 MHz, the separation distance for higher frequency range applies.

NOTE2. These guidelines may not apply in all situations. Electromagnetic propagation is affected by absorption and reflection from structures, objects and people.

Note: This symbol mark is for EU countries only.

This symbol mark is according to the directive 2002/96/EC Article 10 Information for users and Annex IV.



Your MITSUBISHI ELECTRIC product is designed and manufactured with high quality materials and components which can be recycled and reused.

This symbol means that electrical and electronic equipment, at their end-of-life, should be disposed of separately from your household waste.

Please, dispose of this equipment at your local community waste collection/recycling centre.

In the European Union there are separate collection systems for used electrical and electronic product.

Please, help us to conserve the environment we live in!

# CONTENTS

Contents .....	1
Safety precautions .....	2-5
Special features .....	6
Unpacking .....	7
Features and functions .....	8-10
Front panel .....	8
Rear panel .....	9
Remote control unit .....	10
Connections .....	11-16
Connection with a monitor .....	11-13
Connection with video or S-video signal equipment .....	13
Connection with RGB analog signal equipment .....	14
Connection with RS-232C equipment .....	15-16
Before operation .....	17-21
Paper sheet set .....	17
Unlock the printing unit .....	17
Installation of print paper .....	17-19
Installation of ink sheet .....	19-21
Usage and keeping of paper sheet set .....	21
Printing (Basic) .....	22-27
Before printing .....	22-24
Memory print .....	24-27
Memorizing and printing an image .....	25
Image memorizing with page increment set on .....	25
Number of memory pages .....	26
Multiple copy or continuous printing .....	27
Printing (Special) .....	28-33
Multi print .....	28-29
Separate print .....	30
Photo prints .....	30
External remote terminal 1 .....	31
External remote terminal 2 .....	32-33
Setting the functions (Menu chart) .....	34-37
Monitor display chart .....	34-35
LCD display chart .....	36-37
Adjustments & settings (MAIN MENU) .....	38-44
MAIN MENU items .....	38
Operating MAIN MENU .....	38-39
COLOR ADJ (Colour adjustment display) .....	40
LAYOUT (Layout setting display) .....	40-41
PRINT (Print setting display) .....	42
COMMENT (Comment making display) .....	43-44
MEMORY POSITION (Memory and Position setting display) .....	44
Adjustments & settings (SERVICE MENU) .....	45-53
SERVICE MENU items .....	45
Operating SERVICE MENU .....	45
SYSTEM SETUP (System setting display) .....	46-47
GAMMA ADJ (Gamma level setting display) .....	47-48
LAYOUT2&SYSTEM2 (Layout and system setting display 2) .....	48
ANALOG COLOR ADJ (Analog colour adjustment display) .....	48-49
INPUT (Input signal setting display) .....	49
OUTPUT (Output signal setting display) .....	50
KEY SET (Button function setting display) .....	50-51
RS232C SET (RS-232C signal setting display) .....	52
REMOTE SET (Remote signal setting display) .....	52-53
PREVIOUS ERROR (Error display) .....	53
Error messages .....	54
Before calling for service .....	55-56
Overcoming paper jams .....	57
Cleaning .....	58
Spec & options .....	59

<b>PRECAUTIONS</b>
<b>FEATURES</b>
<b>CONNECTIONS</b>
<b>PREPARATION</b>
<b>PRINTING</b>
<b>ADJUSTMENTS</b>
<b>TROUBLE-SHOOTING</b>
<b>OTHERS</b>



# SAFETY PRECAUTIONS

---

In the interest of safety, please observe the following precautions:

## POWER REQUIREMENT

This Colour Video Copy Processor is designed for operation on 220-240V, 50Hz AC. Never connect to any outlet or power supply having a different voltage or frequency.

**WARNING: THIS APPARATUS MUST BE EARTHED.**

**AVERTISSEMENT: CET APPAREIL DOIT ETRE MIS A LA TERRE.**

## PROTECTIVE MEASURES

### IF ABNORMALITIES ARISE, ....

Use of the unit during emission of smoke or abnormal sounds (without adopting countermeasures) is dangerous. In such a case, unplug the power cord from the source outlet immediately, and request maintenance service from the sales dealer.

### NEVER INSERT ANY OBJECT INTO THE UNIT

Foreign objects of any kind inserted into this unit constitute a safety hazard and can cause extensive damage.

### DO NOT PLACE ANYTHING ON THE COLOUR VIDEO COPY PROCESSOR

Heavy objects placed on the Colour Video Copy Processor can cause damage or obstruct proper ventilation.

### PROTECT THE POWER CORD

Damage to the power cord may cause fire or shock hazard. When unplugging, hold by the plug only and remove carefully.

### DO NOT PLACE WATER CONTAINERS ON THE UNIT

Do not place flower vases, and other water-holding containers on the device. If, for some reason, water seeps to the inside of the unit, unplug the power cord from the source outlet, and contact the sales dealer. If used without corrective measures, the unit may be damaged.

"In the interest of safety, avoid handling of liquids near the unit."

### DO NOT REMOVE THE CABINET

Touching internal parts is dangerous, besides, it may lead to malfunction. Contact the sales dealer to carry out internal checks and adjustments. Before opening the cover for eliminating a jammed paper, etc., be sure to disconnect the power cord plug.

### UNPLUG THE POWER CORD DURING A LONG ABSENCE

Turn off the MAIN power switch and unplug the power cord during a long absence.

### WHEN TRANSPORTING THE UNIT

When transporting the unit, remove the ink cassette and paper. Make sure to slide the printing unit lock switch to the lock position.

### BE CAREFUL AROUND PRINT PAPER EXIT SLOT

Do not insert your hand or any material into the paper exit slot during printing.

Do not touch the cutter blade inside the paper exit slot.

Otherwise, your finger will be injured.

### DO NOT TOUCH THE THERMAL HEAD

Do not touch your hand to the thermal head (located inside the unit).

The thermal head is heated to high temperature.

This may cause injury.

### BE CAREFUL WITH THE PRINTING UNIT

Do not move the unit while the printing unit is sliding out. This may cause injury.

Be careful not to catch your finger in the printing unit while the printing unit is being retracted into the unit.

### CONNECTION CABLES

Use the provided power cord. When connecting the unit with an equipment with RS-232C interface, use the RS-232C crossover cable.

## INSTALLATION LOCATIONS

### MAINTAIN GOOD VENTILATION

Ventilation slots and holes are provided on this unit. Place the unit on a hard and level surface and keep a space between the unit and the walls to ensure proper ventilation. When putting the unit on the system rack, take a space between the unit and the back of the rack.

### UNSUITABLE LOCATIONS

Avoid shaky places or hot-springs areas where hydrogen sulfide and acidic ions are likely to be generated.

### PLACES WITH HIGH HUMIDITY AND DUST

Do not place the unit locations with high humidity and dust. They can cause extensive damage. Avoid places where unit is likely to be exposed to oily fumes and vapours.

### PLACES NOT LIKELY TO BE EXTREMELY HOT

Places exposed to direct sunlight, or near heating appliances can attain extremely high temperatures, which may deform the cabinet, or can become a prime cause of damage.

### PLACE THE UNIT ON A HORIZONTAL LEVEL

The unit is likely to be affected if it is placed in slanted conditions or in unstable places.

### PROTECT AGAINST DEW FORMATION

In extremely cold regions, if the unit is moved quickly from an extremely cold place to warmer one, dew is likely to be formed. If dew is formed, printing is not possible.

### OPERATING AMBIENT TEMPERATURE RANGE

The operating ambient temperature range is 41°F - 104°F (5°C to 40°C), and humidity of 20 - 80% RH. When using the unit on the system rack, be sure to keep this ambient temperature inside the rack.

## FOR LONG OPERATING LIFE

### UNSUITABLE MATERIALS FOR THE COLOUR VIDEO COPY PROCESSOR

Coat flaking and deformation are likely to occur if the unit is wiped with chemical dusters, benzene, thinner or any other solvent, if rubber or PVC items are left in contact with the unit for extended duration, or if the unit is sprayed with insecticide.

### CARE OF THE CABINET

Unplug and clean with a soft cloth slightly moistened with a mild soap and water solution. Allow to dry completely before operating. Never use petroleum base solutions or abrasive cleaners.

### HEAD ABRASION

The thermal head, like the video head, wears out. When it is abraded, it becomes hard to print out fine details of the picture. In such a case, it is necessary to replace the thermal head. Consult with the sales dealer for replacing the head.

### CONNECTING DEVICES

Read thoroughly "Operating Precautions" of the instruction booklets for the devices connected with the Colour Video Copy Processor.

The power cord must be disconnected after printing is over.

### CAUTION ON RELOCATING

When transporting this unit, make sure it is not likely to be subjected to impacts. They can be a prime cause for damage. Further, make sure to disconnect the power cord from the power outlet, and the cables from the connected devices.

# SAFETY PRECAUTIONS

## SAFETY CHECKS

- Periods: According to the recommendations of the manufacturer of the medical devices.
- Scope:
- a) Visual inspection  
Housing, leads, controls, displays, labels/markings, accessories, operation manual.
  - b) Functionality test  
Testing of functions (according to operation manual) as well as compatibility and usability of devices and accessories.
  - c) Electrical test  
Testing of electrical safety of the system according to EN60601-1.

High humidity or dust

Avoid locations with high humidity and dust in order to avoid malfunctioning of the device.

Also avoid locations subject to corrosive gasses and smoke.

Heat

Direct sunlight, heaters or other heat sources may deform the housing and subsequently cause malfunctioning.

## TECHNICAL DESCRIPTIONS

The supplier will make available on request such circuit diagrams, component part lists, descriptions, calibration instructions or other information which will assist the USER's appropriately qualified technical personnel to repair those parts of the EQUIPMENT which are classified by the manufacturer as repairable.

The use of ACCESSORY equipment not complying with the equivalent safety requirements of this equipment may lead to a reduced level of the resulting system

Consideration relating to the choice shall include:

- use of the accessory in the PATIENT VICINITY.
- evidence that the safety certification of the ACCESSORY has been performed in accordance to the appropriate EN60601-1 and/or EN60601-1-1 harmonized national standard.

The transportation and storage environmental conditions are:

Temperature : -20°C - +60°C (-4°F - +140°F)

Humidity : 90% RH or less at 40°C (104°F)

Note: The above transportation environmental conditions indicate the storage environmental conditions during transport.

## OTHER CAUTIONS

Dust or other foreign matter adhering to the print paper or the ink cassette, or deformation resulting from exposure to extremely low or high temperatures could cause loss of colour, uneven colour or lines, or wrinkles in the print images.

If there is noise or vibration in the VCR still-image or playback picture, the print image may be distorted or the upper part may be crooked.

### NOTE:

**YOUR UNDERSTANDING IS REQUESTED FOR THE LOSS OF IMAGES IN MEMORY DUE TO THE SUDDEN OCCURRENCE OF A MALFUNCTION.**

As for paper sheet set, refer to Page 17, "Paper sheet set".

## THERMAL PAPER

- When the remaining length of the paper is about 25cm (10"), a color belt appears at the paper end. Prepare for replacement of the paper. If the remaining paper length is less than 25cm (10"), printing becomes uneven due to the uneven paper core surface.
- When the printed paper is touched by wet hand, the print may be discoloured.
- When the paper runs out during printing, the printing operation stops and "CHANGE PAPER" is displayed by the LCD on the front panel. Install new paper at this time.
- Store the printed paper in a place with low humidity free from a direct sunlight.
- If the paper absorbs nonvolatile organic solvents (alcohol, ester, ketone, etc.) the print may be discoloured. Particularly, if the paper comes in contact with soft vinyl chloride such as a transparent tape, it quickens discoloration.
- Do not use paper other than the specified one.
- Immediately after the paper is replaced, 2-3 images may be printed with a blank part due to hand's dust or oil.
- Avoid a direct sunlight or a place near a heater, and store the paper in a place with 30°C (86°F) or lower temperature and 35-80% RH.
- When the paper is rapidly transferred from a cool place to a hot place, a vapour or a dew is generated on the paper surface causing paper jam or degraded printing quality.
- A finger print or dust on the paper surface may degrade the printing quality.

### Note:

Mitsubishi brand thermal paper is specially treated with an antistatic coating against thermal head damage caused by static-electricity discharge.

The use of non-treated paper may cause premature head failure in your product.

# SPECIAL FEATURES

---

## SPECIAL FEATURES

### **AVAILABLE IN VARIOUS MEDICAL FIELDS, INCLUDING ENDOSCOPY DIAGNOSIS**

3 kinds of colouring characteristics (gamma curve) are employed, which are the best for medical diagnostic devices, including endoscope requiring precise images and ultrasound diagnostic equipment etc. The colour is reproducible for each diagnostic equipment with easy operation. Each gamma curve is adjustable for each user flexibly.

### **2 PRINT SIZES ARE AVAILABLE ACCORDING TO THE PURPOSE**

2 printing sizes, L size (max.110 x 160 mm) and S size (max.110 x 105 mm), are selectable.

### **MULTI PRINT FUNCTION BY THE CAPACIOUS FRAME MEMORY**

As this unit has 3 frame memories, it can store an image during its printing. So the time of diagnosis will be shorten remarkably.

### **HIGH SPEED PRINTING**

Printing speed is approx. 12 seconds (in S size print). Using a rollpaper shortens the time for installing and removing.

### **LARGE CAPACITY OF PRINTING**

Maximum number of printing (S size) is 200 printings per a roll paper. The large capacity of rollpaper printing reduces a time of exchanges.

### **POSSIBLE OF PRINTING IN HIGH QUALITY**

High quality print is available in sublimation dye thermal method which is superior in repeatability of images. It also employs 256 gradients and about 16,700,000 colours in each YMC.

### **325 PPI HIGH RESOLUTION**

325 PPI (Pixel Per Inch) high resolution clears the image data. Precise illustrations and photo images can be printed sharply.

### **MULTI PRINT FOR VARIOUS DEMANDINGS**

2, 4, and 16 images of multi print are available. Several multi print modes are selectable according to demanding.

### **UNIQUE COLOUR IMAGE CONTROL SYSTEM WITH THE IC CHIP BUILT IN INK SHEET ROLLS**

By setting the supplied IC chip to ink cassette, the remaining of ink sheet can be displayed. It also controls the colours of the printing images.

### **WIDE COMPATIBILITY WITH A VARIETY OF INTERFACE AND SYSTEMS**

- (1) Input and output control signals from RS-232C/Rear remote interfaces
- (2) Fixing function to internal sync. signal avoiding the loop phenomena of sync. signal
- (3) Stroboscope sync. function responding to fundus camera system
- (4) Image adjusting function such as contrast, brightness, depth etc. of printing image
- (5) Capable of storing 3 kinds of setting and adjustment according to each using condition.

# UNPACKING

## UNPACKING

Take the unit out of the box by the following procedures. Make sure to check the contents.

**1** Open the top of the box.

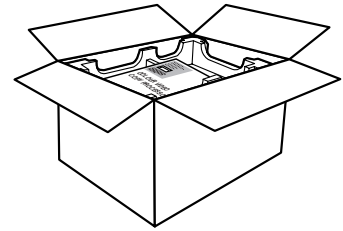

**2** Remove the cushion with contents.

Be careful not to drop the contents.

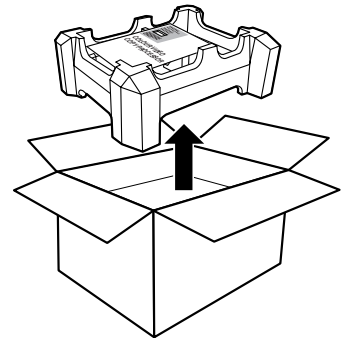

**3** Take the unit out of the box carefully.

Make sure to keep the unit horizontally.

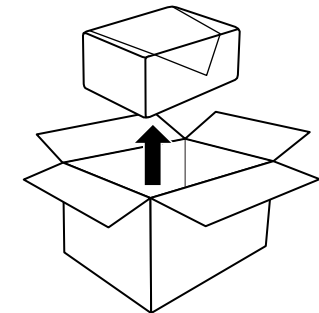

**4** Unwrap the packing.

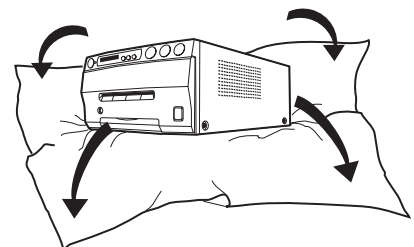

### CONTENTS

Make sure to check the supplied contents on the cushion.

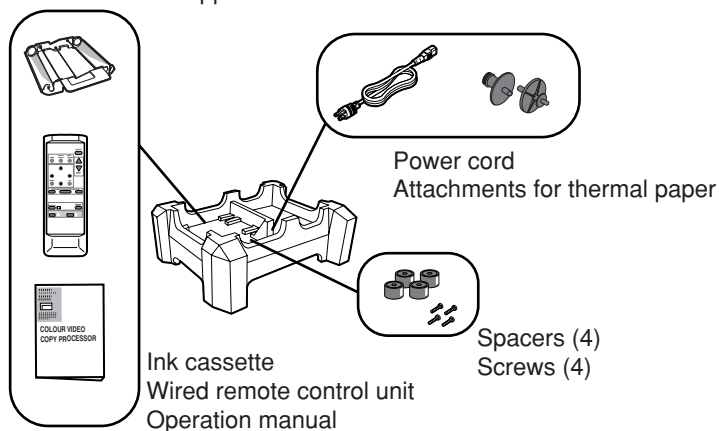

PRECAUTIONS

FEATURES

CONNECTIONS

PREPARATION

PRINTING

ADJUSTMENTS

TROUBLE-SHOOTING

OTHERS

# FEATURES & FUNCTIONS

## FRONT PANEL

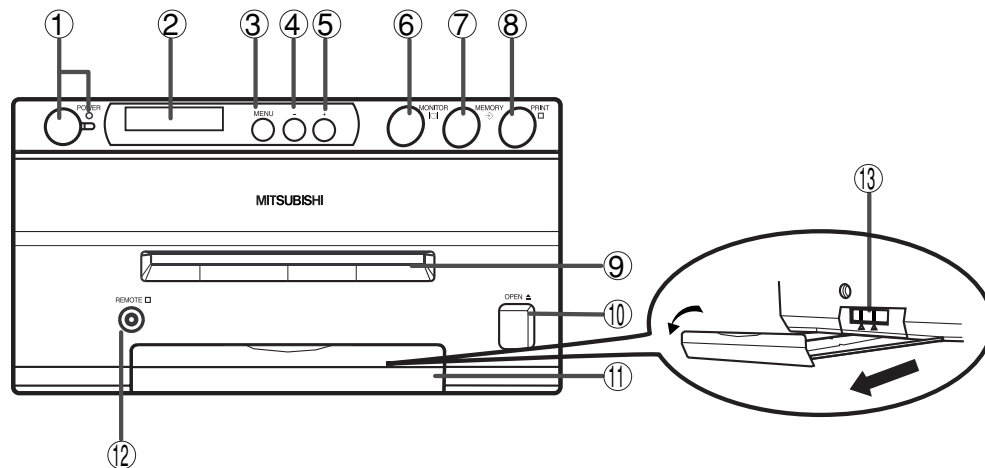

### ① POWER BUTTON(INDICATOR)

Press to turn on power. Press again to turn off power. When the power is turned on, the indicator illuminates.

### ② LCD (LIQUID CRYSTAL DISPLAY)

Indicates input signal settings and various function modes and settings. Use the menus on the monitor or LCD for setting functions. See pages 36 - 37.

### ③ MENU BUTTON

Press for colour adjustment. The item will be switched in order of ;  
 SELECT COLOR/B&W→BRT→CONT→R-SUB→G-SUB  
 →B-SUB→CENTER[+]→CANCEL[+]→SET[+]→SELECT  
 COLOR/B&W. (When selecting B&W, R-SUB, G-SUB, B-  
 SUB change to Y-SUB, M-SUB, C-SUB.)  
 To go back to the normal screen, press ⑤PLUS(+) button  
 while SET[+] is selected. The above menu is displayed on  
 the monitor screen. See page 40.

### ④ MINUS(-) BUTTON

Press to decrease the value of each setting item. To set  
 the value, select SET[+] with ③MENU button and press  
 ⑤PLUS(+) button.

### ⑤ PLUS(+) BUTTON

Press to increase the value of each setting item. To set  
 the value, select SET[+] with ③MENU button and press  
 this button.

### ⑥ MONITOR BUTTON

Switches the display on the monitor. When this button is  
 pressed, the picture on the monitor screen switches  
 between the picture of the input signal (source image) and  
 the memorized image.  
 When pressing MEMORY button while holding this button,  
 print paper will be fed and cut automatically, and the  
 mechanism will be initialized. Make sure to press  
 MONITOR button first, or a new image will be memorized.

### ⑦ MEMORY BUTTON

Press to memorize the image to be printed. When signal  
 is not inputted, memory is not available.

### ⑧ PRINT BUTTON

Press to print the image memorized by the MEMORY  
 button. The image on the monitor screen switches to  
 Source image when printing starts. When image is not  
 memorized, printing is not available.

### ⑨ PRINT OUTLET

The printed paper comes out here.  
 Do not put any objects in front of the outlet.

### ⑩ OPEN BUTTON

Press to slide out the printing mechanism. Make sure to  
 unlock ⑬PRINTING UNIT LOCK SWITCH. When it is not  
 working, turn off the power once. Then try to press this  
 button again.  
 Open the mechanism to load paper and ink cassette or to  
 clear a paper jam.

### ⑪ TRAY

Holds the printed paper which was come out from the print  
 outlet. Press down the knob to pull the tray. Make sure to  
 pull it out before using this unit.

### ⑫ REMOTE TERMINAL

Connects the remote control unit supplied.

### ⑬ PRINTING UNIT LOCK SWITCH

Locks the printing unit.  
 Shift the switch to the left (LOCK side) to lock and to the  
 right (UNLOCK side) to unlock.  
 This unit is locked when shipping. When transporting this  
 unit, make sure to lock the unit.

## REAR PANEL

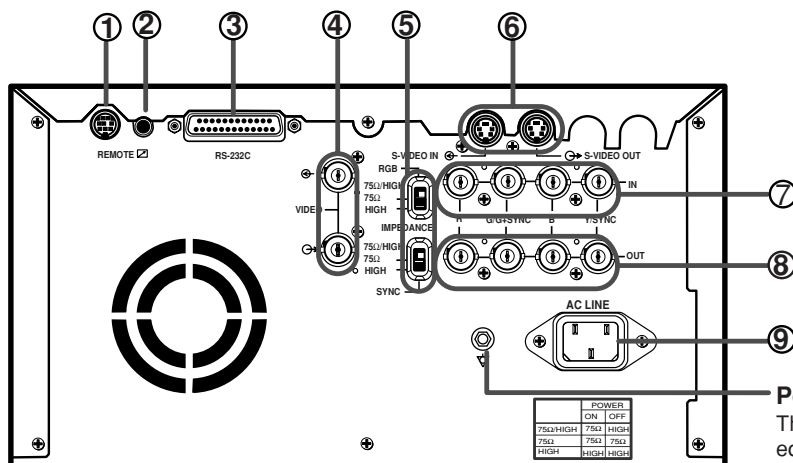

### Potential equalization connector

This is used to equalize the potential of the equipment connected to the unit. For details, refer to the installation instruction of the equipment to be connected.

### ① REMOTE TERMINAL 2 (MINI DIN 8 PIN)

Memorizing images and printing is available by the remote signal inputted through this terminal. It is necessary to make a circuit for remote control unit to use the function. See pages 32-33.

### ② REMOTE TERMINAL 1 (STEREO JACK)

Memorizing images is available by the remote signal inputted through this terminal. It is necessary to make a circuit for remote control unit to use the function. See page 31.

### ③ RS-232C PORT

Use these terminals to connect this unit to a device equipped with RS-232C interface. See pages 15-16.

### ④ VIDEO SIGNAL INPUT/OUTPUT TERMINAL

Use these terminals to connect this unit to VIDEO signal equipment. See pages 13.

### ⑤ IMPEDANCE SWITCH [IMPEDANCE RGB SYNC.]

This is a 75ΩHIGH/75Ω/HIGH impedance selection switch for RGB or Sync. signal.

### ⑥ S-VIDEO INPUT/OUTPUT TERMINAL

Use these terminals to connect to S-VIDEO signal equipment. See pages 13.

### ⑦ RGB ANALOG INPUT TERMINALS [R G/G+SYNC B H+V-SYNC]

This is a BNC type input terminal for a RGB analog signal. The sync. signal can be automatically selected between H/V composite and SYNC. ON GREEN (sync. signal imposed on the green video signal) signals. See page 14.

### ⑧ RGB ANALOG OUTPUT TERMINALS [R G/G+SYNC B H+V-SYNC]

This is a monitor output terminal for a RGB analog signal. The sync. signal can be selected between 0.3V (H+V-SYNC) and TTL (H+V-SYNC) signals. See page 14.

### ⑨ AC LINE SOCKET

Connects to the provided power cord. Insert the cord firmly.



## REMOTE CONTROL UNIT

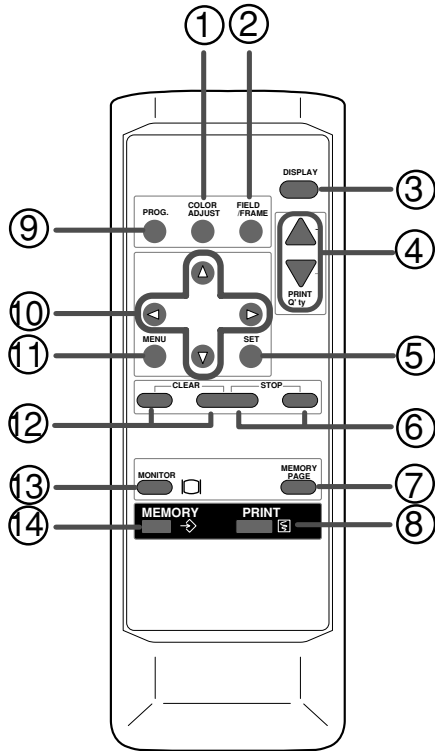

### ① COLOR ADJUST BUTTON

Press to display the COLOR ADJUST menu. See page 40.

### ② FIELD/FRAME BUTTON

Press to switch FRAME and FIELD mode of input signals. The selected mode is displayed on the monitor screen and LCD. FRAME is good for high quality printing of still images, and FIELD is good for printing fast movement images. See page 22.

### ③ DISPLAY BUTTON

Press to display the set condition on the monitor screen. Press again to switch off the display.

### ④ PRINT QUANTITY ▲, ▼ BUTTONS

Use to set the number of copies to be printed. The set number of copies is displayed on the monitor and on the front LCD. Press ▲ to increase the number and ▼ to decrease the number. When pressing ▲ or ▼ button during printing, the counter becomes "1" and continuous printing is cancelled. It also cancels the reserved printing. See page 27.

### ⑤ SET BUTTON

Press to go to SAVE PRG. Repress to memorize the values and exit the MENU mode. See page 34-35.

### ⑥ STOP BUTTONS

Press to cancel the printing process and start mechanical initializing. When pressing these buttons during displaying MAIN MENU, SERVICE MENU will be displayed.

### ⑦ MEMORY PAGE BUTTON

Use to select the image memorized. The memory page is switched every time this button is pressed. The selected memory page mark illuminates.

### ⑧ PRINT BUTTON

Press to print the image memorized by the MEMORY button.

### ⑨ PROGRAM BUTTON

Press the PROG. button to select between 3 types of user presets. Functions previously set with the MENU can be stored into one of 3 memories and recalled. Programs cannot be changed during printing. It may take longer to change the program.

### ⑩ ▲, ▼, ◀, ▶ BUTTONS

Use to set the MENU display. Values are increased/decreased and the cursor position is changed with these four buttons. These buttons are also used to select one of memorized images. See page 38 and 45.

### ⑪ MENU BUTTON

Press to display MAIN MENU used for various settings. See pages 34-35.

### ⑫ CLEAR BUTTONS

Press to eliminate all or a part of memorized images.

### ⑬ MONITOR BUTTON

Press to switch the image of the input signal and the memorized image being displayed.

### ⑭ MEMORY BUTTON

Use to memorize the image to be printed. The memorized image is displayed on the monitor screen for one second, then the image of the input signal is displayed.

# CONNECTIONS

The functions of this unit can be set by the menu screens displayed on the monitor.

- Connection with a monitor
- Connection with VIDEO/S-VIDEO signal equipment
- Connection with RGB analog signal equipment
- Connection with RS-232C equipment

Connect this unit with a monitor to check the images to be printed and the images stored in memory. The following examples show the connections with a video signal, S-video signal, RGB analog signal and RS-232C equipment. Connect with the necessary signal equipment.

Make sure to turn off the power of the unit and connecting equipment before connection.

## CONNECTION WITH A MONITOR

Make sure to turn off the power before setting.

(EXAMPLE)

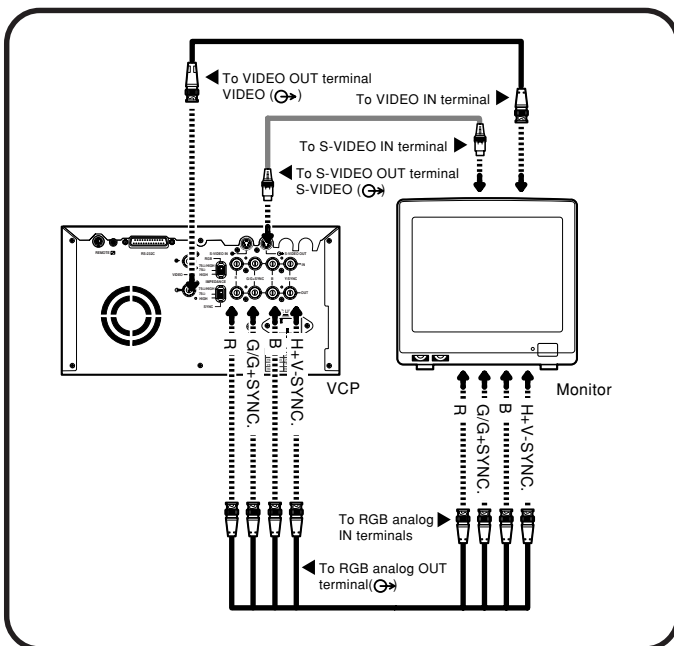

### NOTE

When the sync. polarity or sync. signal of a monitor to be connected is not adjusted to the initial setting of this unit, the image may not be displayed correctly. In this case, adjust the sync. polarity and sync. signal output to the monitor. When the image is displayed correctly, the setting is not required. (Refer to the operation manual of the monitor as for the sync. polarity and sync. signal of the monitor.)

- The sync. polarity and sync. signal is set by the menu displayed on LCD.

#### 1 Press MENU button.

MAIN MENU is displayed.

#### 2 Press STOP buttons on remote control unit.

SERVICE MENU is displayed.

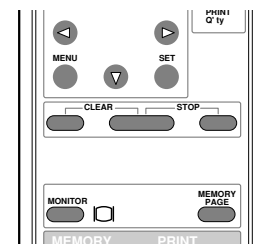

M; INPUT rgb

S;SYSTEM [>]

## CONNECTIONS

**3** Press ▼ button to select INPUT menu.

S;INPUT [>]

**4** Press ► button.

INPUT menu is displayed. Set the monitor polarity with "IN SYNC" on this menu.

**5** Press ▲ or ▼ button to select "IN SYNC".

The sync. signal level being selected, for example, "ttl" is displayed.

SI;IN SYNC ttl

**6** Set the sync. signal level according to the equipment to be connected. Press ◀ or ▶ button to select "ttl", "sog" or "0.3v".

ttl Inputs the TTL level sync signal.

sog Inputs the Sync. On Green level sync signal.

0.3v Inputs the 0.3Vp-p level sync signal.

**7** Press SET button.

The function is set, and SERVICE MENU is displayed.

SER;SAVE prg.1

**8** Press ▲ or ▼ button to select OUTPUT menu.

S;OUTPUT [>]

**9** Press ► button.

OUTPUT menu is displayed. Set the signal output with "OUT SYNC" and "RGB SOG" on this menu.

SO;MONI RSUB 0

**10** Press ▲ or ▼ button to select first "OUT SYNC". Press ◀ or ▶ button to select "auto" or "user".

The sync. signal setting being selected, for example, "auto" is displayed.

auto Outputs the same sync signal as IN SYNC setting.

user Sets the signal output.

SO;OUT SYNC auto

**11** When setting "user" on **10**, select second "OUT SYNC," and set the sync. signal level according to the equipment to be connected. Press ◀ or ▶ button to select "0.3v" or "ttl."

0.3v Outputs the 0.3Vp-p sync signal.

ttl Outputs the TTL level sync signal.

SO;OUT SYNC 0.3v

**12** Press ▲ or ▼ button to select third "OUT SYNC".

**13** Set the monitor's polarity according to the equipment to be connected. Press ◀ or ▶ button to select "nega" or "posi."

SO;OUT SYNC nega

14 Press ▲ or ▼ button to select “RGB SOG”.

SO;RGB SOG off

15 Press ◀ or ▶ button to select “on” or “off”.

You can select whether Sync. ON Green signal is added to the output signal or not. When “on” is selected, Sync. ON Green signal is output and when “off” is selected, only Green signal is output. Select “on” or “off” according to the monitor to be connected.

- off Only Green signal is output.
- on Sync. On Green signal is output.

16 Press SET button.

SERVICE MENU is displayed and “SAVE” is indicated.

SER;SAVE prg.1

17 Press ◀ or ▶ button to memorize the setting in prg.1, 2, or 3. Select “CANCEL” to cancel the setting.

18 Press SET button.

The source image (input signal from the equipment) is displayed.

The setting of the sync. polarity and signal is completed.

## CONNECTION WITH VIDEO OR S-VIDEO SIGNAL EQUIPMENT

Make sure to turn off the power before setting.

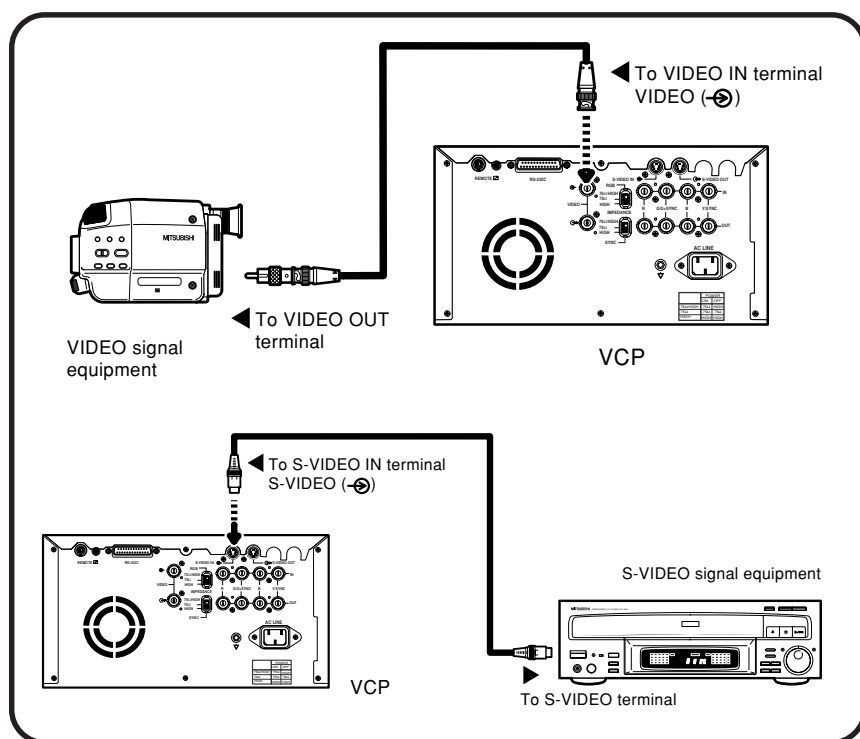

## CONNECTION WITH RGB ANALOG SIGNAL EQUIPMENT

Make sure to turn off the power before setting.

(EXAMPLE)

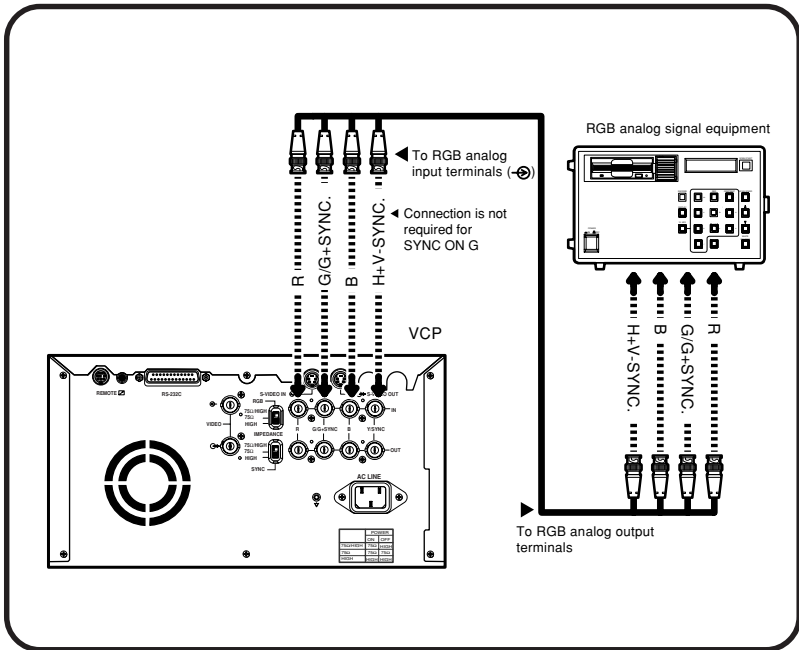

This unit is designed to accept RGB video at the PAL frame rate, nominally 15.75kHz horizontal and 50Hz at vertical.

- 1** Connect this unit and RGB analog signal equipment with a BNC cable.
- 2** Set the RGB IMPEDANCE switch to “75Ω/HIGH”. Set the sync. signal IMPEDANCE switch to “HIGH”.

**IMPEDANCE SWITCH**

RGB	75Ω/HIGH	Power ON: 75Ω termination
		Power OFF: No termination
	75Ω	Power ON/OFF: 75Ω termination
	HIGH	Power ON/OFF: High impedance - No termination
SYNC	75Ω/HIGH	Power ON: 75Ω termination
		Power OFF: No termination
	75Ω	Power ON/OFF: 75Ω termination
	HIGH	Power ON/OFF: High impedance - No termination

The normal settings are: RGB 75Ω/HIGH and SYNC : HIGH

When the printer is between the RGB video source and the monitor the normal settings should be used. If the 75Ω termination is not set correctly, the video will be either too dark or too bright.

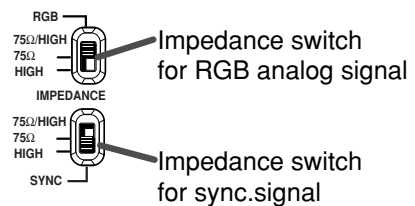

## CONNECTION WITH RS-232C EQUIPMENT

This unit can be controlled through a RS-232C port with custom software. (Image data can not be input.)  
For the protocol, consult your dealer.

Make sure to turn off the power before setting.

### ■ RS-232C TERMINAL SIGNAL

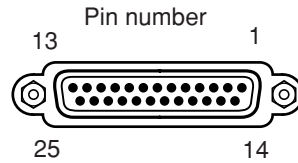
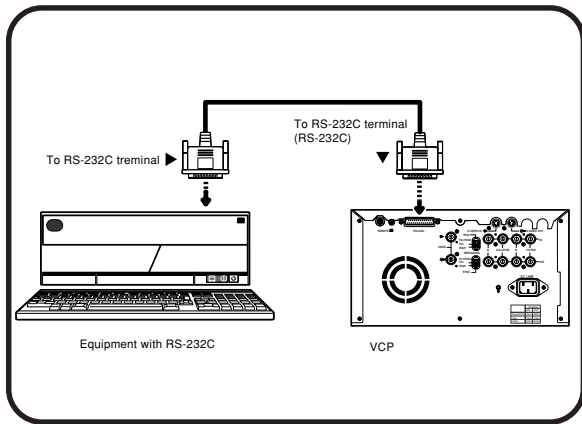

Pin No.	Signal line name	Description	Directions
1	FG	Protective	---
2	TXD	Transmitted data	Output
3	RXD	Received data	Input
4	RTS	Request to send	Output
5	CTS	Clear to send	Input
6	DSR	Data set ready	Input
7	GND	Signal ground	---
20	DTR	Data terminal ready	Output

**1** Connect this unit and RS-232C equipment with a crossover cable.

#### RS-232 Connection Cable (Crossover cable)

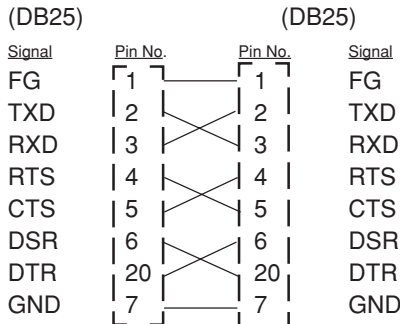

#### RS-232 Connection Cable

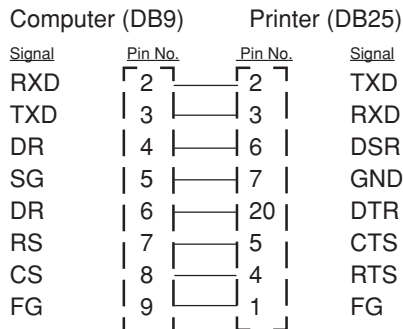

- #9 on the 9 Pin end of the cable is typically tied to the Shield.
- This is just an example. Make sure to check the connection type for the using equipment.

**2** Set the baud rate according to the equipment to be connected.  
Press MENU button, then press STOP buttons on remote control unit.  
SERVICE MENU is displayed.

S;SYSTEM
[>]

**3** Press ▼ button to select "RS232C."

S;RS232C
[>]

## CONNECTIONS

**4** Press **▶** button.

RS232C menu is displayed.  
Set "BAUD RATE" on this menu.

S2;BAUD RATE1200

**5** Press **▲** or **▼** button to select "BAUD RATE".

The setting BAUD RATE (e.g. 1200) will be displayed.

**6** Press **◀** or **▶** button to select "1200", "2400", "4800" or "9600" (bit/s).

**7** Press **▲** or **▼** button to select "COMMAND TYPE".

S2;COMMAND TYPEa

**8** Press **◀** or **▶** button to select "a", "b" or "c".

Select "a" for normal setting. Depending on the connected equipment, select "b" or "c".

**9** Press **SET** button.

SERVICE MENU is displayed.  
"SAVE" is indicated.

SER;SAVE prg.1

**10** Press **◀** or **▶** button to memorize the setting in "prg.1", "prg.2" or "prg.3."

Select "CANCEL" to cancel the setting.

**11** Press **SET** button.

The source image (input signal from the equipment) is displayed.

**The setting of BAUD RATE and COMMAND TYPE is completed.**

**12** Set the communication format of the computer with a computer connected.

Synchronizing system : Asynchronous communication  
Data bit length : 8 bits  
Parity bit : Nothing  
Stop bit length : 1  
Transmission order : Sent from LSB  
Baud rate (bit/sec.) : 1200, 2400, 4800, 9600

# BEFORE OPERATION

Before printing,

1. Unlock the printing unit. (See below)
2. Install the print paper and ink cassette. (pages 17-21)

## PAPER SHEET SET

When using this unit for printing, make sure to use the following types of paper sheet and ink sheet set.

### PAPER SHEET SET

Product name	Ink sheet size	No. of prints	Usage
CK900S	S size	200	Colour print
CK900L	L size	130	Colour print
CK900S4P	S size	130	Surface-laminated colour print
CK900L4P	L size	90	Surface-laminated colour print
CK900S4P(HX)EU	S Size	130	Surface-laminated colour print for ID photo
CK900L4P(HX)EU	L Size	90	Surface-laminated colour print for ID photo

### THERMAL PAPER

Product name	Print size	No. of prints	Usage
KP65HM-CE	S/L size	S size Approx.200 L size Approx.125	Thermal print

### PAPER INK SHEET CASSETTE

Product name	Ink sheet size	No. of prints	Usage
PKC900S	S size	200	Colour print
PKC900L	L size	130	Colour print

## UNLOCK THE PRINTING UNIT

### RELEASING THE PRINTING UNIT LOCK

- 1 Press down the knob to pull out the tray.

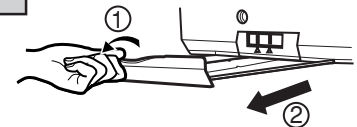

- 2 Shift the printing unit lock switch to the right (UNLOCK). (See page 8.)

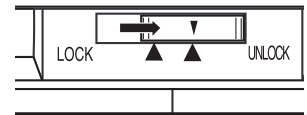

## INSTALLATION OF PRINT PAPER

When using the thermal paper, prepare the following steps first.

- 1 Set the supplied paper attachments to both sides of the thermal paper.

#### NOTE

Set the attachment with gear on the left side.  
Make sure to set them correctly.

- 2 Pull out the thermal paper about 20cm and cut it.

Remove the part with seal paste, dust and fingerprints.

- 3 Cut the both corners of the paper.

Installation for the thermal paper is completed.

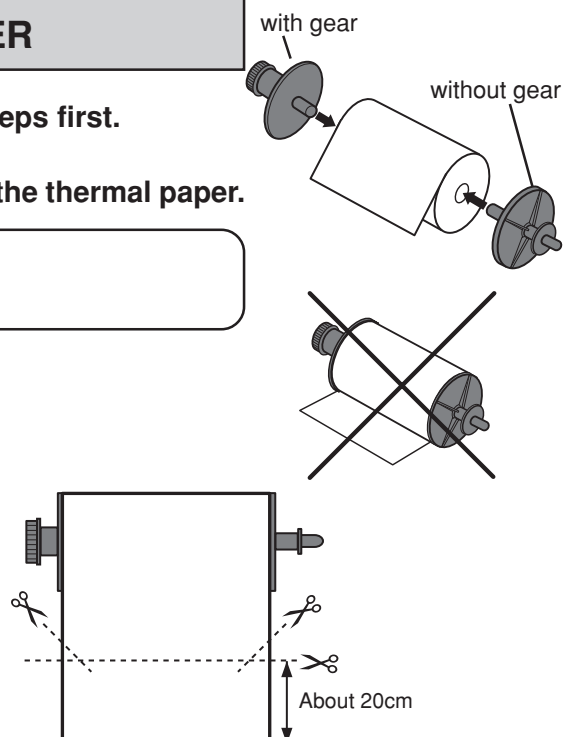

PRECAUTIONS

FEATURES

CONNECTIONS

PREPARATION

PRINTING

ADJUSTMENTS

TROUBLE-SHOOTING

OTHERS



# BEFORE OPERATION

## ■ INSTALLATION OF PRINT PAPER

Do not remove the seal on the print paper yet.  
When using thermal paper, remove the seal as shown on the previous page.

- 1** Insert the print paper roller with gear on the left.  
Press the folder ① as shown right, and set the print paper roller.

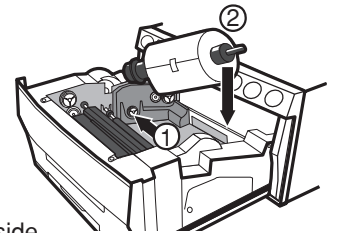
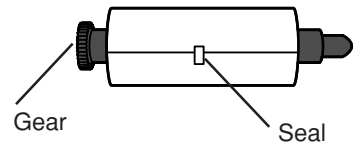

Front side

- 2** Set the other side of roller without gear.

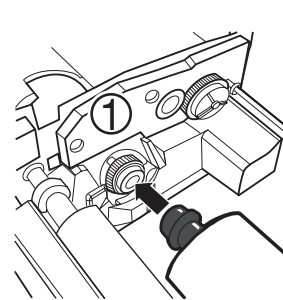

Left side

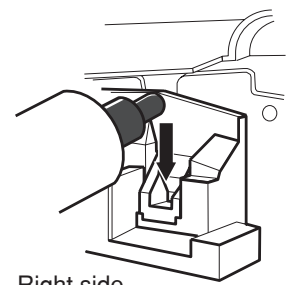

Right side

- 3** Remove the seal, and insert the edge of the print paper right below the roller cover with arrow marks towards the front panel.  
Make sure to insert the paper straight.

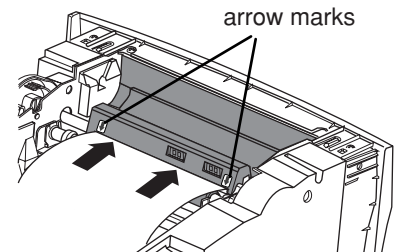

- 4** Feed the print paper through the paper outlet with your hand.

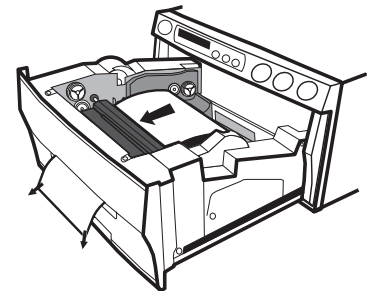

- 5** Pull the both side of the print paper to eliminate slack.

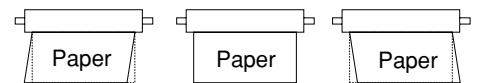

INCORRECT CORRECT INCORRECT

## ■ PRECAUTIONS ON SETTING THERMAL PAPER

When setting the thermal paper, observe the following precautions to prevent paper jam.

- **Do not use defective paper.**

Do not use the bent or wrinkled paper.

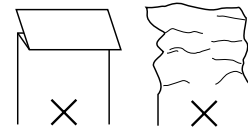

- **Adjust the paper position correctly.**

When the paper is fed out skewed from the print exit, adjust the paper position so that it is fed out straight.

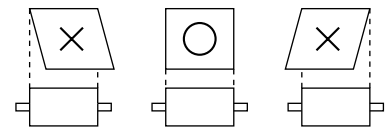

- **Do not slack the roll paper.**

Set the paper tightly to remove any slack.

- **Make the paper side even.**

If the side of the print paper is uneven or the core is sticking out, the amount of paper feeding after printing may vary.

When the side of paper is uneven or the core is sticking out, install the print paper after making the paper side even.

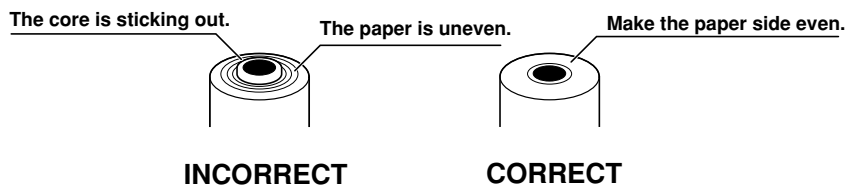
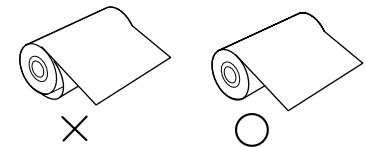

- **Other cautions**

- Keep the high-density paper away from fingerprint, dust or moisture when storing it.
- Do not touch the rubber roller. Do not stain or damage the roller surface.
- Do not touch the thermal head (located inside the unit). When printing, the thermal head is heated to high temperature.
- Do not touch the cutter blade.

## INSTALLATION OF INK SHEET

### ■ INSTALLING THE INK SHEET

Load the ink sheet roll to the ink cassette before inserting the ink cassette into the printer.

**1 Put the ink sheet rollers with flat tops into the holes of ink cassette.**

Put the white roller (rolled with ink sheet) to the ink cassette first.

Then, put the colored roller (without ink sheet) to the ink cassette.

**2 Put the other sides of rollers. Set IC at this time.**

The IC chip with the IC holder is attached to the ink sheet.

Set the IC holder to the ink cassette as shown right.

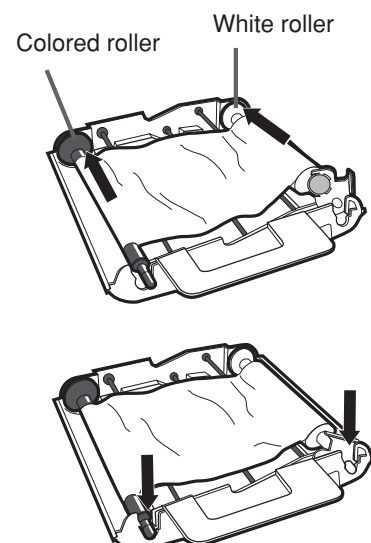

# BEFORE OPERATION

### NOTE

- Do not remove the IC chip or IC holder from the ink sheet. Removal of the IC will stop the printer from functioning correctly.
- Set the projected part of the IC holder to the correct position as shown below.

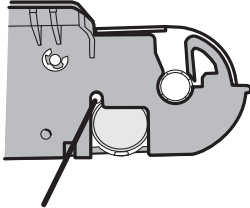

Projected part

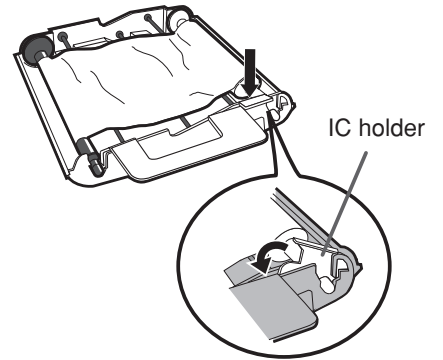

## ■ INSTALLING THE INK CASSETTE

### 1 Eliminate any slack of the ink sheet.

Hold the colored roller and turn the white roller.

### 2 Insert the ink cassette with the ink sheet into its compartment.

Put the ink cassette of the ink sheet with flat top side to each ①. Then, set the other side (with handle) as shown right. When exchanging the ink cassette and so on, remove it by holding the handle. (See page 57.)

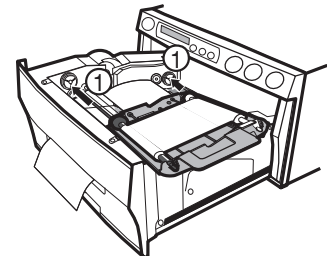
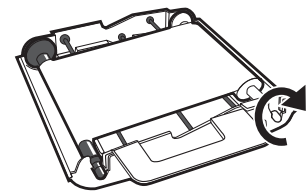

### NOTE

Do not install the ink cassette when printing with thermal paper, otherwise printing may be failed.

## ■ INSERTING THE PRINTING UNIT

### 1 Push the printing unit until it is locked into place.

### 2 After plugging the power cord, press POWER button on the front panel.

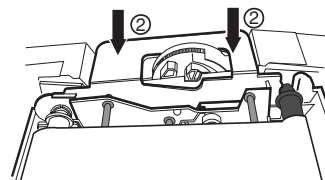

### 3 After the set conditions are displayed on the monitor, press MEMORY button about 1 second with holding MONITOR button on the front panel.

The print paper is automatically cut after feeding about 10 cm (4 inches).

### 4 Repeat the above step 3 once or twice.

Fingerprints and dust can be removed by feeding the print paper. The printing mechanism is initialized.

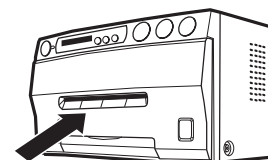

**NOTE**

- Make sure to press MONITOR button first for operating [3] and [4]. Pressing MEMORY button first operates to memorize the images. When exchanging the printing paper or ink cassette during using the unit, the recorded images may be erased by pressing MEMORY button first.
- Do not feed the print paper more than 2 times. Doing so will not allow the number of prints indicated on page 17 to be printed.
- When thermal paper is running out, red lines appear on both sides of the paper. Install a new roll of paper, otherwise printing may be failed.

**The installation of print paper and ink cassette is completed.**

**NOTE**

An IC is built in the ink sheet. This is the IC chip, not a battery. This IC can be thrown away as normal waste.

**NOTE**

If the power is turned on and AUTO FEED&CUT on SYSTEM SETUP menu is set to ON, "SET PAPER" on the monitor and LCD disappear when print paper is inserted under the roller. (For AUTO FEED&CUT setting, refer to page 46.) After inserting ink sheet and closing the printing mechanism, the print paper is automatically fed and cut twice.

**NOTE**

Take the print paper one by one after completing printing. Pull out the tray completely when using it. If you fail to do so, paper jamming may occur. Put the tray back when finishing printing.

**USAGE AND KEEPING OF PAPER SHEET SET**

**BEFORE PRINTING**

- Fingerprints or dust on the paper's surface may degrade print quality and cause paper jams. Immediately after the paper is replaced, 2 images may be printed with a blank part due to hand's dust or oil. Refer to Pages 17 - 18.
- When print paper is rapidly transferred from a cool place to a hot place, vapor or dew will be generated on the paper's surface causing paper jams or degraded print quality. Leave the print paper in the room to stabilize its temperature before using it.
- When print paper and ink sheet run out during printing, the printing operation stops and the error messages such as "CHANGE PAPER" and "CHANGE INK" is displayed on the monitor and LCD display. Set new ink sheet or print paper. Refer to Pages 17-20.

**AFTER PRINTING**

- When the printed paper is touched by a wet hand, the print may be discolored.
- Fading may occur if the print-face is exposed to organic chemical agents which may affect print paper (e.g. alcohol, ester, ketone based).
- Fading will be accelerated upon contact with PVC-based materials (e.g. adhesive tapes, rubber erasers, etc.).
- Avoid storing prints in direct sunlight or places with high humidity.

**STORAGE**

- Leaving the print paper in contact with PVC-based materials causes color of print paper to come off and to be stained.
- Never store print paper in places that are close to heater, hot humid or dusty. Keep print paper in a place where;
  - Temperature : 5°C - 30 °C (41°F - 86°F)
  - Humidity : 20 - 60%RH

# PRINTING (BASIC)

## BEFORE PRINTING

### ■ SELECTING FIELD/FRAME

Press FIELD/FRAME button on the remote control unit to select “FIELD” or “FRAME”.

- Select “FRAME” for a high resolution still image printing.  
Select “FIELD” for a picture of quickly moving objects.
- When “FIELD” is selected, the print image will be lower in resolution.  
The selected mode is displayed on the monitor screen and LCD of this unit.
- A video picture is normally composed of two slightly lower resolution images (FIELD images) to form a single image (FRAME image).

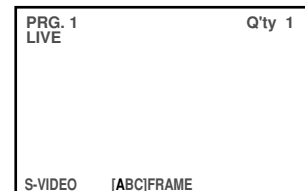
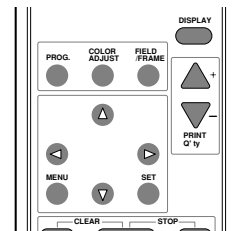

### ■ SELECTING INPUT SIGNAL

- Select VIDEO, S-VIDEO or RGB according to the input signal.
- The appropriate input signal may already be selected through the RS-232C control software.
- The input signal can be set on the menu displayed on the monitor screen and LCD.
- Unless the input signal is changed, it is not necessary to select the input signal every time.

#### 1 Press MENU button.

MAIN MENU is displayed.

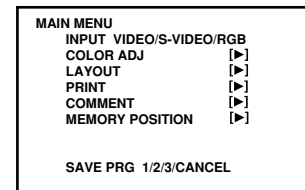

#### 2 Press ▲, ▼ button to select “INPUT”.

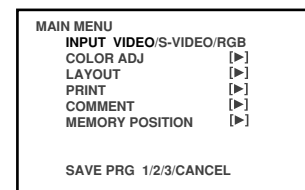

#### 3 Press ◀, ▶ button to select “VIDEO”, “S-VIDEO”, or “RGB”.

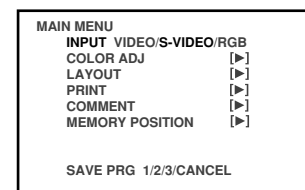

#### 4 Press SET button.

- “SAVE PRG 1/2/3/CANCEL” is selected.
- This menu let you select a program memory (1-3) to store your new settings.

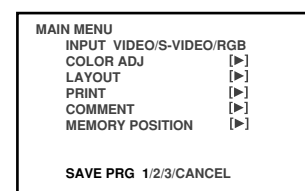

**5 Press ◀, ▶ button to select one of the program number (1-3) to memorize the setting.**

The program is replaced. In case of keeping the stored program, do not select the program number in which the setting is stored.

**6 Press SET button.**

The source image is displayed.

The selecting of input signal is completed.

**■ SELECTING PRINT SIZE**

- "AUTO" is selected for initial setting. "S" is selected when THERMAL is set to "ON".
- Select "AUTO" or "S" according to the print size.  
 AUTO : Selects print size automatically according to the installed ink sheet.  
 S : Selects S size regardless of the installed ink sheet.  
 When selecting THERMAL:ON,  
 L : Prints with L size.  
 S : Prints with S size.
- The print size can be set on the menu displayed on the monitor screen and LCD.
- Unless the ink sheet size is changed, it is not necessary to select the print size every time.

**1 Press MENU button to display MAIN MENU.**

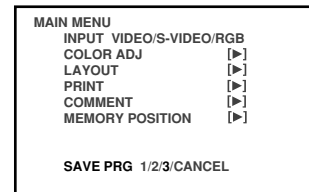

**2 Press ▲, ▼ button to select "LAYOUT".**

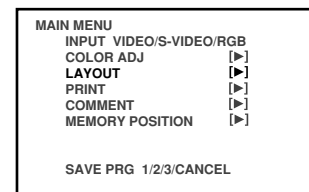
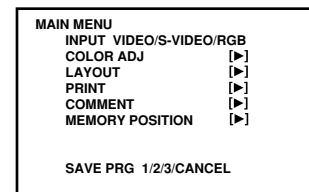

**3 Press ▶ button.**

- LAYOUT is displayed.
- Normally, "MODE" is selected when opening LAYOUT. When other item is selected, press ▲ or ▼ button to select "MODE".

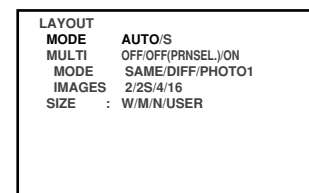

**4 Press ◀, ▶ button to select "AUTO" or "S". (Select "L" or "S" when THERMAL is set to ON.)**

- Select "AUTO" for normal setting. Select "S" to print S size with L size ink sheet.
- When printing with thermal paper, L or S size printing is available by selecting "L" or "S".

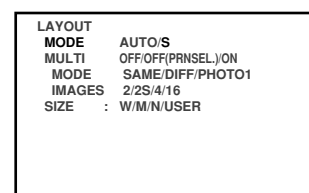

PRECAUTIONS

FEATURES

CONNECTIONS

PREPARATION

PRINTING

ADJUSTMENTS

TROUBLE-SHOOTING

OTHERS

# PRINTING (BASIC)

## 5 Press SET button.

- MAIN MENU is displayed.
- "SAVE PRG 1/2/3/CANCEL" is selected.
- This menu lets you select a program memory (1-3) to store your new settings.

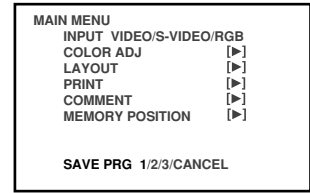

## 6 Press ◀, ▶ button to select one of the program memory (1-3) to memorize the setting.

The program is replaced. In case of keeping the stored program, do not select the memory number in which the setting is stored.  
When "CANCEL" is selected, the settings are not memorized.

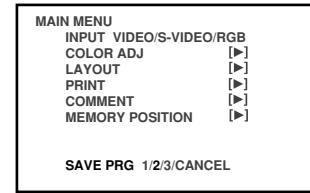

## 7 Press SET button.

The source image is displayed.

The print size setting is completed.

# MEMORY PRINT

In the single image mode, this unit has 3 FRAMES of image memory and the following functions are available.

- Each time the FIELD/FRAME button is pressed, the display changes to show the Field or Frame mode.
- Frames are shown as [ABC]FRAME, and since one Frame consists of two Fields, the Frame letter is shown (in green) along with the Field display as "1" or "2" (in green) as [ABC]FIELD1/[ABC]FIELD2.
- Press MEMORY PAGE button to advance the Memory Page to the next Field or Frame. The selected page number is shown in green. The memory page in which the next image will be memorized is shown in yellow. If the selected page number and the next memory page are the same, the number will be shown in yellow.
- The image will be stored in the selected memory page when MEMORY button is pressed.
- When pressing MONITOR button, the image of memory page which is currently selected is displayed on the monitor.

When displaying a memory image, "MEMORY" is shown on the monitor. When displaying the image from the connected equipment, "LIVE" is shown. When pressing MEMORY PAGE button, the selected memory page is displayed.

- An image can be stored into memory while printing, but not in the memory currently being printed.

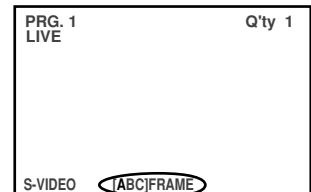

Available memory page (A is chosen).  
[ABC]FIELD1/[ABC]FIELD2 is displayed for FIELD.  
[ABC]FRAME is displayed for FRAME.

## MEMORIZING AND PRINTING AN IMAGE

### 1 Display the image which you wish to print.

- The memory page can be changed by pressing MEMORY PAGE button on the remote control unit.

### 2 Press MEMORY button.

- The selected page is shown in yellow.
- When pressing MONITOR button to show “MEMORY” on monitor display, the image on the selected memory page will be displayed on monitor.

### 3 Press PRINT button.

- The image displayed on the monitor will be printed.
- The memory page which is print stand-by is shown as “\_”, and it goes on and off during printing.

#### NOTE

When selecting OFF(PRNSEL.) in MULTI, 4 memory pages are displayed on the monitor. However, only the selected page can be printed.

## IMAGE MEMORIZING WITH PAGE INCREMENT SET TO PAGE

When INCREMENT is set to “PAGE” (automatic memory page advance system), the followings are the memory operations.

- Every time pressing MEMORY button, the memory page is switched in order of A→B→C, and image will be memorized in it.
- To memorize an image on a memory page you selected, press MEMORY PAGE button first to select the memory page. Then, press MEMORY button to memorize the image.
- When selecting OFF(PRNSEL.) in MULTI, the memory page is switched in order of A→B→C→ D→A→B... by pressing MEMORY button.  
For FIELD, the memory page is switched in order of A1→B1→C1→D1→A2→B2→C2→D2→A1→B1....by pressing MEMORY button.

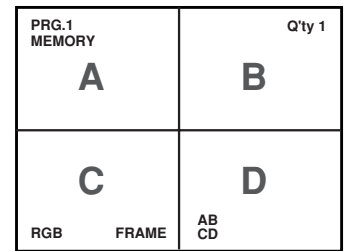

Memory page display



Selecting A and printing it.

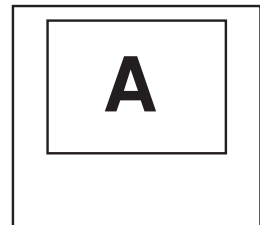

(example) S size printing



# PRINTING (BASIC)

## NUMBER OF MEMORY PAGES

As this unit has 1280 pixel x 600 lines x 3 frames of memory, the following memory operations are available.

MODE : DIFF  
(Multi printing the different images)

MULTI \	FRAME	FIELD	PRINT EXAMPLE
2 2S	1 page	2 pages	
4	1 page	2 pages	
16		2 pages	

MODE : SAME  
(Multi printing the same images)

MULTI \	FRAME	FIELD	PRINT EXAMPLE
2 2S	3 pages	6 pages	
4	3 pages	6 pages	
16	3 pages	6 pages	

MODE : PHOTO1

MULTI \	FRAME	FIELD	PRINT EXAMPLE (S size print)
CARD	3 pages	6 pages	
3x4	3 pages	6 pages	
5x5	3 pages	6 pages	
3x3.5	3 pages	6 pages	

MULTI : OFF

MULTI \	FRAME	FIELD	PRINT EXAMPLE
OFF	3 pages	6 pages	
OFF (PRNSEL.)	4 pages	8 pages	

- Because the FIELD mode has half the vertical resolution of the FRAME mode, the printed image may be low in quality.

## ■ MULTIPLE COPY OR CONTINUOUS PRINTING

Multiple copies of a memorized image can be made by setting the number of prints to more than one. The print quantity can be set for up to 200 prints or for continuous printing until the paper or ink sheet is used up. Multiple quantity printing can be cancelled if needed.

### 1 Press PRINT Q'ty ▲, ▼ button to set the number of prints to be printed.

- The number of prints is displayed on the monitor screen.
- The number will increase by pressing PRINT Q'ty ▲ and decrease by pressing PRINT Q'ty ▼.
- The number switches in the order of:  
1 ↔ 2 ↔ ... ↔ 9 ↔ 10 ↔ 20 ↔ 30 ↔ 40 ↔ 50 ↔ 100 ↔ 200 ↔ C ↔ 1  
When you set to "C", continuous printing will be done until the paper or ink sheet is used up.

### 2 Press PRINT button.

- The number of prints you set is printed.
- During continuous printing (except for selecting "C"), the set number on the monitor or LCD will be counted down every time one sheet is printed. When printing is completed, the counter will be reset to the original set number. This will not reset when turning off the power (It will not be reset to "1".)
- If you wish to stop printing;
  - Press PRINT Q'ty ▲ and ▼ buttons. After printing the current page, the counter will be reset to "1." Pressing PRINT Q'ty ▲ and ▼ buttons are also available to cancel the reserved printing.
  - If you wish to stop printing without completing the current page, press STOP button. The image will be printed incompletely and come out from the print outlet.

#### NOTE

If a blackish image is continuously printed, the internal temperature may rise and cause the unit to switch to a stand-by condition during printing. In this case, an error message "OVER HEAT" will be displayed on the monitor and LCD. Wait until the error message goes off. When temperature drops and the message goes off, printing resumes.

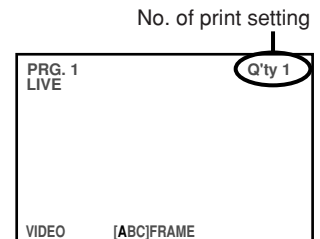

PRECAUTIONS

FEATURES

CONNECTIONS

PREPARATION

PRINTING

ADJUSTMENTS

TROUBLE-SHOOTING

OTHERS

# PRINTING (SPECIAL)

Various types of printing are available by setting on the menu screen (MAIN MENU and SERVICE MENU). In this section, some examples of special prints are given. For each setting, see pages 34-37.

## MULTI PRINT

MULTI PRINT is the function which 2, 4 or 16 images can be printed on a sheet. Use LAYOUT of MAIN MENU for setting. For the setting, refer to page 40-41. For PHOTO1 setting, refer to "Photo print" on page 30.

MODE: SAME, DIFF

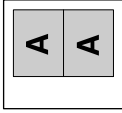
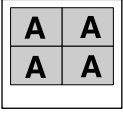
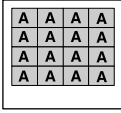
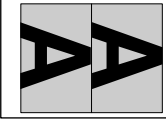
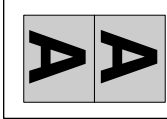
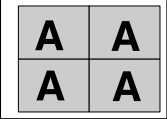
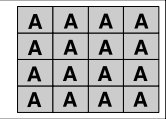
	2	2S	4	16
S size prints				
L size prints				

- MODE : DIFF  
When setting IMAGES to "2 (2S)," 2 images are available to be stored in each FRAME: Page A, or each FIELD1,2: Page A.
- MODE :DIFF  
When setting IMAGES to "4," 4 images are available to be stored each FRAME: Page A, or each FIELD1,2 :Page A.
- MODE :DIFF  
When setting IMAGES to "16," memory is not available in FRAME: Page A. 16 images are available to be stored in FIELD:Page A.
- MODE : SAME  
1 image is available to be stored in each FRAME: Page A-C or in each FIELD1,2: A-C.

### NOTE

- When printing 2 images on S size sheet, some characters of the comment will be clipped.
- When printing 2 images on L size sheet, the images may be partially clipped. In this case, adjust the image position by "PRN V AREA" of LAYOUT2&SYSTEM2 in SERVICE MENU so that the image moves to the proper position, or use 2S mode. See page 41,48.

## ■ WHEN SETTING TO MODE : DIFF, IMAGES :4;

Repeat the following procedure to store the set number of images in memory.

- 1 Press DISPLAY button to display the set condition.**
- 2 Press MONITOR button and select the source image (“LIVE” is displayed on the monitor.) to display the image to be stored.**
- 3 Press MEMORY button to store the image to be printed.**
  - For normal setting, when the image is stored, the source image (LIVE image) is displayed after displaying the stored image about 1 second.
- 4 When selecting the position to store the image, press MEMORY PAGE button to select the memory page.**
  - Press ▲, ▼, ◀, ▶ button to determine the position to store the image.
  - The image is stored in the selected memory page.
  - The position number where the image can be stored is indicated in yellow.

## ■ WHEN SETTING TO MODE : SAME, IMAGES : 4;

Only one image will be displayed on the monitor screen.

- 1 Press DISPLAY button to display the set condition.**
- 2 Press MONITOR button and select the source image (“LIVE” is displayed on the monitor.) to display the image to be stored.**
- 3 Press MEMORY button to store the image to be printed.**
  - When the image is stored, the source image (LIVE image) is displayed after displaying the stored image about 1 second. (When MEM&MONI:OFF in SERVICE MENU)
- 4 When selecting the memorizing page (A, B, C), press MEMORY PAGE button to select .**
  - The position number where the image can be stored is indicated in yellow.

**SEPARATE PRINT**

- The SEPARATE print is a function to insert a white frame between 2 or more images.
- Use LAYOUT2&SYSTEM2 of SERVICE MENU for setting. See page 48.

**NOTE**

The amount of white frame in multi print is different between on the monitor and the printed image.  
 The image size changes according to "SIZE" of LAYOUT menu.  
 The setting just before printing applies to all the multi print images.

**PHOTO PRINTS**

- PHOTO print is a function to print the images on the photo size (3 x 4 cm, 5 x 5 cm, 3 x 3.5 cm) and CARD (2 x 1.5cm) size.
- CARD size print is suited to stick on a business card.
- Use LAYOUT of MAIN MENU for setting. Refer to page 46 for setting.
- The following prints are available.

MODE: PHOTO1

	CARD	3 x 4	5 x 5	3 x 3.5
S size prints				
L size prints				

## EXTERNAL REMOTE TERMINAL 1

The image can be stored in memory by sending the remote signal through the external remote terminal on the rear panel. When the MEM&PRN(MEMORY & PRINT) function is set to ON, the image will be printed after being stored in memory.

- Make out the necessary circuit to use this function by referring to the following.

### EXTERNAL REMOTE TERMINAL SIGNAL ALLOCATION (STEREO JACK)

Pin No.	Function	Description
①	Ground	Earth
②	MEMORY	Memory : When the signal becomes "LOW" from "HIGH", the image is stored in memory. (When the signal has been "LOW" for 15ms or more, the image is stored in memory. See page 51, 52.)
③	BUSY1	Refer to the BUSY LEVEL setting of REMOTE SET in SERVICE MENU. See page 52.

- When the signal from BUSY terminal is received with TTL level, keep the following.  
 $|I_{OL}| = 2\text{mA}$  or less,  $|I_{OH}| = 1\text{mA}$  or less  
 $|I_{OL}|$  means the current flowing into the unit at Low output,  $|I_{OH}|$  means the current flowing out of the unit at High output.
- Just after completing printing, there is a period that memory signal is not accepted.



Circuit inside and pin No.

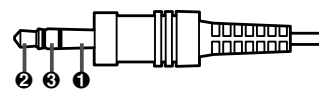

Plug pin No.

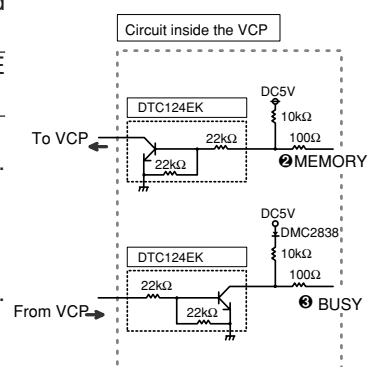

PRECAUTIONS

FEATURES

CONNECTIONS

PREPARATION

PRINTING

ADJUSTMENTS

TROUBLE-SHOOTING

OTHERS

**EXTERNAL REMOTE TERMINAL 2**

The image can be stored in memory and printed by sending the remote signal through the external remote terminal on the rear panel.

- Make out the necessary circuit to use this function by referring to the following.

**EXTERNAL REMOTE TERMINAL SIGNAL ALLOCATION (MINI DIN8PIN)**

Pin No.	Function	Description
①	Ground	Earth
②	MEMORY	Memory : When the signal becomes “LOW” from “HIGH”, the image is stored in memory. (When the signal has been “LOW” for 15ms or more, the image is stored in memory. See page 51, 52.)
③	BUSY2	Refer to the BUSY LEVEL setting of REMOTE SET in SERVICE MENU. See page 52.
④	BUSY1	Refer to the BUSY LEVEL setting of REMOTE SET in SERVICE MENU. See page 52.
⑤	PRINT	When the signal becomes “LOW” from “HIGH”, the stored image is printed. (When the signal has been “LOW” for 15ms or more, the image is printed.)
⑥	REMOTE	The same functions as the supplied remote control can be controlled.
⑦	Unused	
⑧	DC3V	Power supply for the remote control DC 1mA Max.

- When the signal from BUSY terminal is received with TTL level, keep the following.  
 $|I_{OL}| = 2\text{mA}$  or less,  $|I_{OH}| = 1\text{mA}$  or less  
 $|I_{OL}|$  means the current flowing into the unit at Low output,  $|I_{OH}|$  means the current flowing out of the unit at High output.
- Just after completing printing, there is a period that memory signal is not accepted.

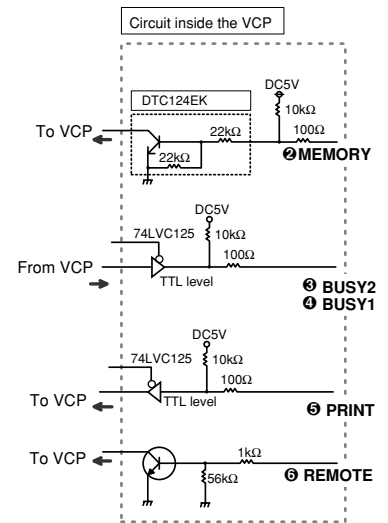
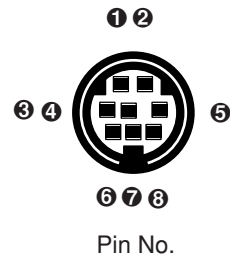

## PIN NO. ⑥ REMOTE TERMINAL

By sending the following remote control codes from pin No.6, the same functions as the wired remote control unit supplied can be controlled.

01: ◀ button	02: ▶ button	03: ▼ button	04: ▲ button
08: PRINT Q'ty ▲ button	09*		
0A*: MENU button	0B*: CLEAR button	0C: PRINT Q'ty ▼ button	
0D*	0E*: SET button	0F*: STOP button	
12*: PROGRAM button	13*: PRINT button	15*: FIELD/FRAME button	
16*: COLOR ADJUST button	17*: MEMORY button	18*: DISPLAY button	
1C*: MEMORY PAGE button	1D*: MONITOR button		

In case of the codes with \* mark, 5 words are sent.

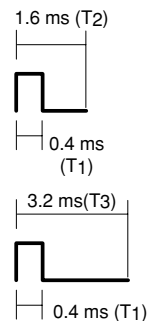

(The above values are references.)

## TIMING CHART

Input signal level	:	TTL
Input timing	:	1 word 38.4 ms (Reference)
		$T_1 \geq 0.4 \text{ ms}$
		$1.5 \text{ ms} < T_2 < 2 \text{ ms}$
		$2 \text{ ms} < T_3 < 4.2 \text{ ms}$
		$13 \text{ ms} < T_4 < 90 \text{ ms}$

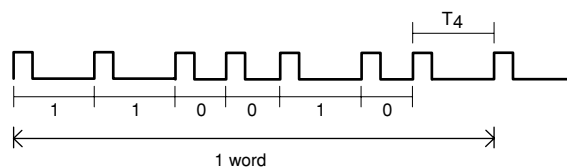

(EXAMPLE) Print code  
= 13 = 0 1 0 0 1 1

PRECAUTIONS
FEATURES
CONNECTIONS
PREPARATION
PRINTING
ADJUSTMENTS
TROUBLE-SHOOTING
OTHERS



# SETTING THE FUNCTIONS (MENU CHART)

## MONITOR DISPLAY CHART

### OPERATION

is reference page.

is the name of button on remote control unit.

is the name of button on front panel.

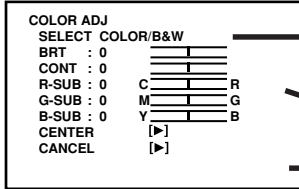

Press ◀, ▶ button to change the value, select the mode or switch the item.

Select an item with ▲, ▼ button.

Monitor display

\*1 When going back to MAIN MENU or SERVICE MENU without saving the setting, press MENU button.

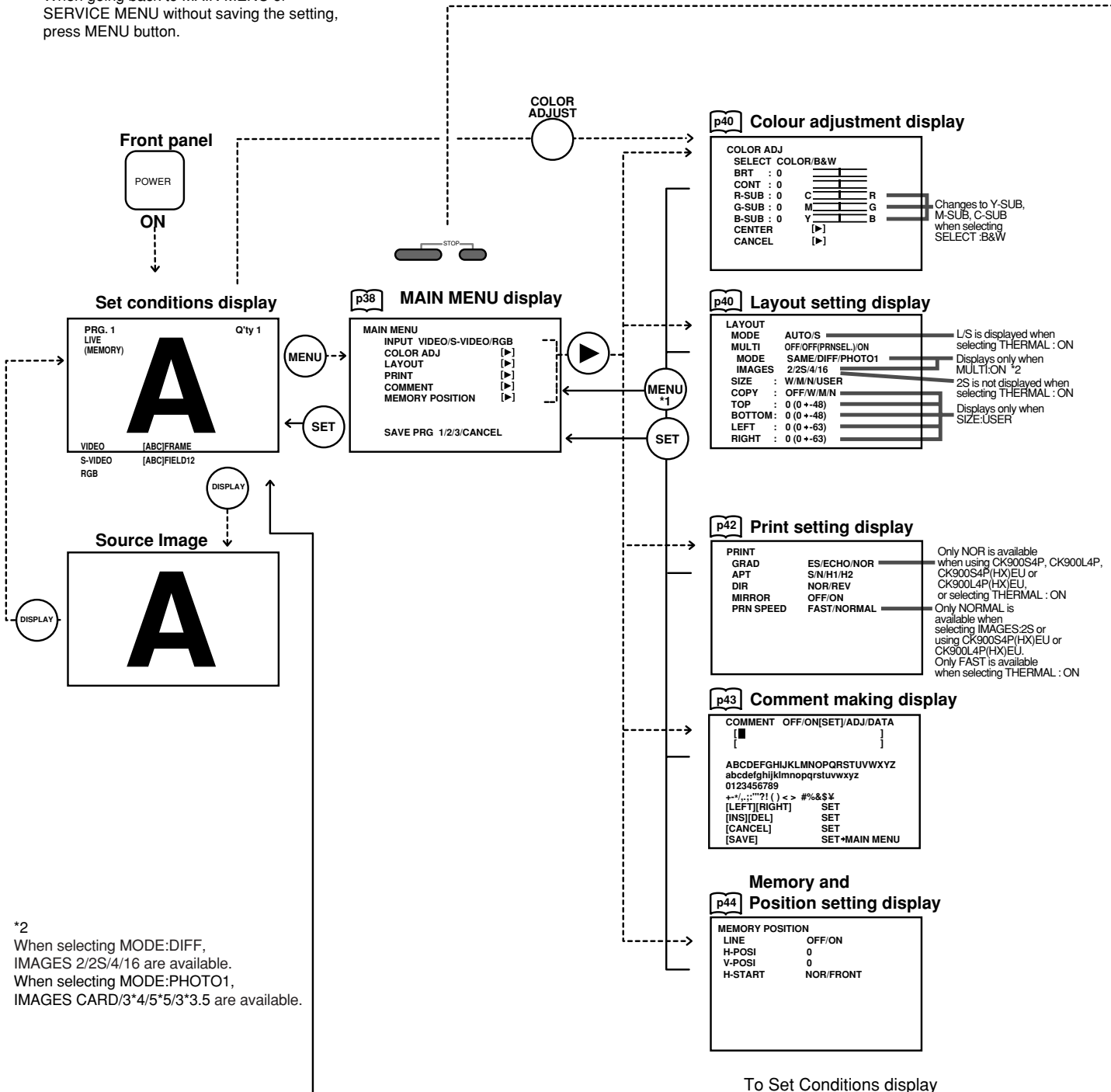

\*2 When selecting MODE:DIFF, IMAGES 2/2S/4/16 are available.  
When selecting MODE:PHOTO1, IMAGES CARD/3\*4/5\*5/3\*3.5 are available.

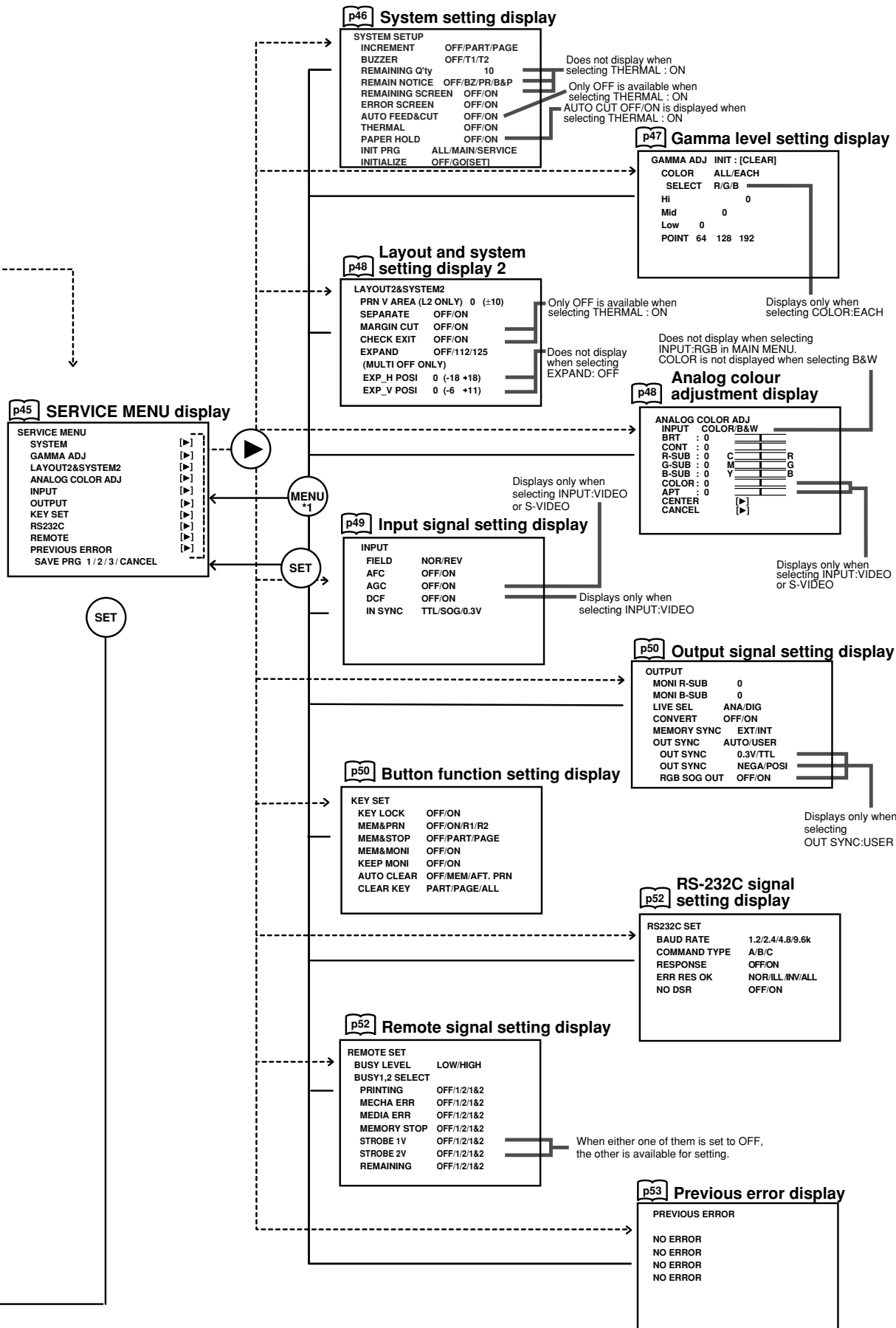

# SETTING THE FUNCTIONS (MENU CHART)

## LCD DISPLAY CHART

### OPERATION

is reference page.

is the name of button on remote control unit.

is the name of button on front panel.

\*1 When going back to MAIN MENU or SERVICE MENU without saving the setting, press MENU button.

MC:SELECT	color
BRT	0
CONT	0
R-SUB	0
G-SUB	0
B-SUB	0
CENTER	[>]
CANCEL	[>]

LCD display

The menus in the broken lines are indicated by ▲, ▼ button.

Press ◀, ▶ buttons to change the value, select mode or switch the item. (The item indicated by switching is shown in light character in this chart.)

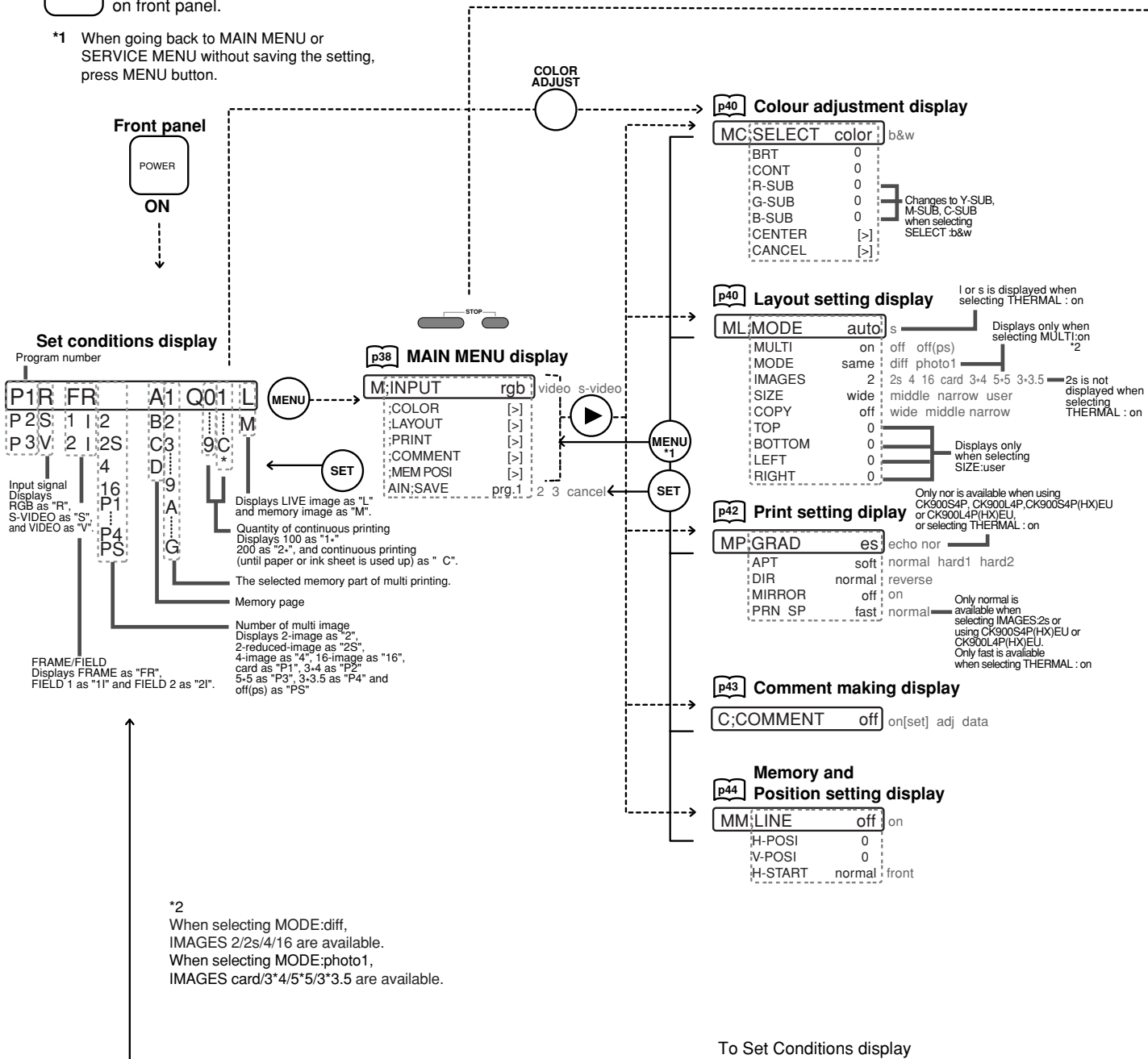

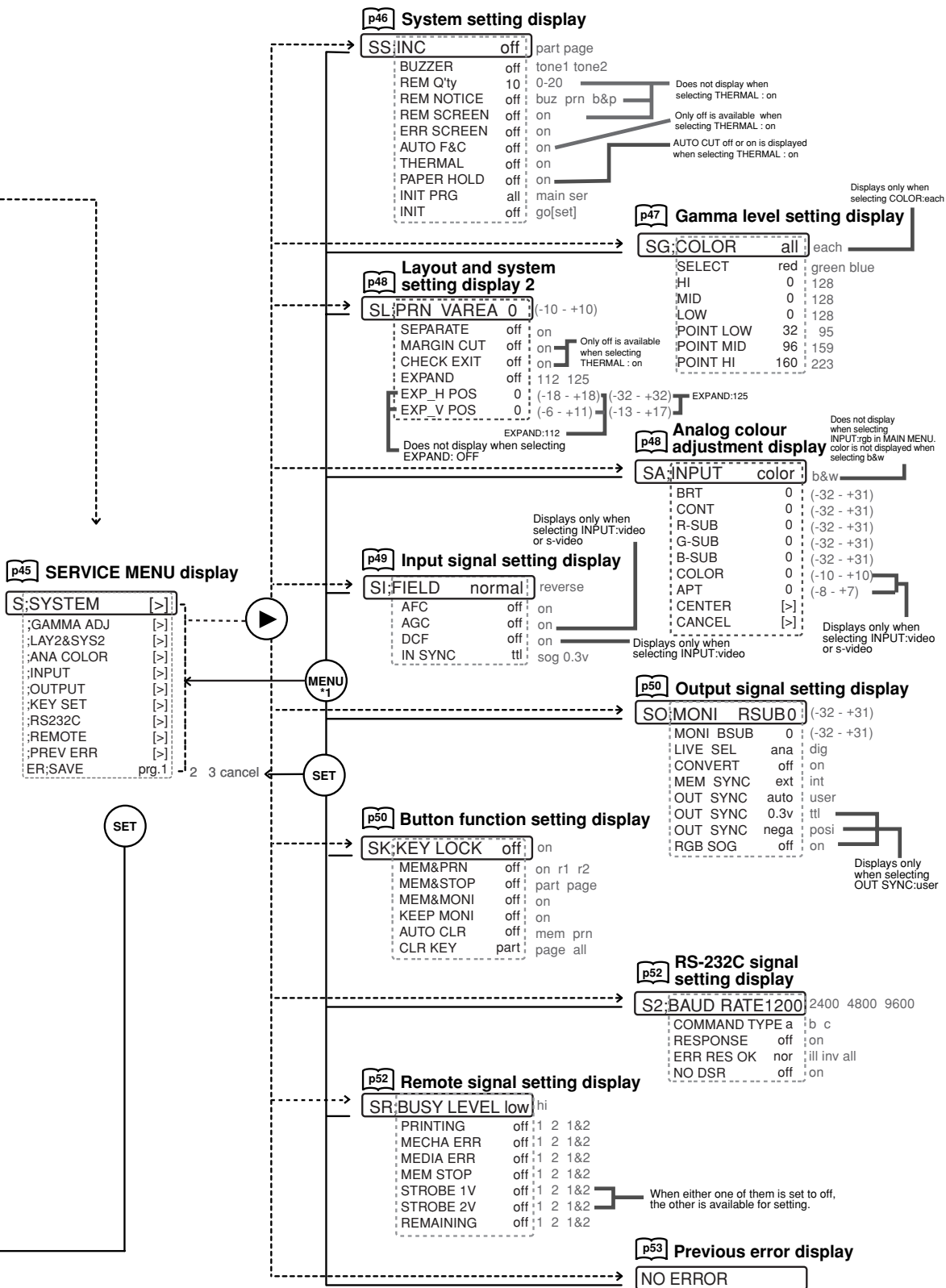

# ADJUSTMENTS & SETTINGS (MAIN MENU)

## MAIN MENU ITEMS

MAIN MENU is used to open sub-menus. The functions are set with the following 6 menus. The settings can be saved by SAVE PRG.

INPUT	Selects the input signal through the terminal on the rear panel
VIDEO	Signal from video signal input terminal
S-VIDEO	Signal from S-video signal input terminal
RGB	Signal from RGB signal input terminal
COLOR ADJ	Adjusts colour of printing image
LAYOUT	Adjusts the image layout setting
PRINT	Adjusts gamma characteristic, image outline, selects print direction, mirror print (left/right inversed) and printing speed
COMMENT	Making a comment
MEMORY POSITION	Selects print position
SAVE PRG	Stores the above settings in one of 3 program memories

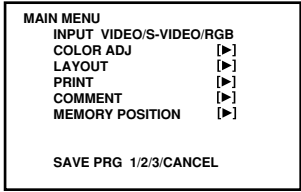

Monitor display

## OPERATING MAIN MENU

Use the buttons on the remote control unit to display MAIN MENU and select and set functions.

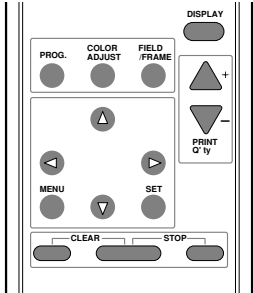

- 1 Press **MENU** button to display MAIN MENU.
- 2 Select your desired item by pressing **▲** or **▼** button.

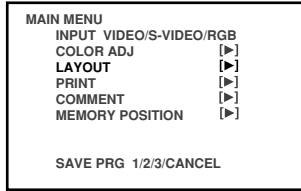

(EXAMPLE) Selecting LAYOUT display

- 3 Press **▶** button to open a sub menu.

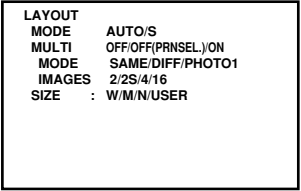

- 4 Select an item you wish to adjust by pressing **▲** or **▼** button.

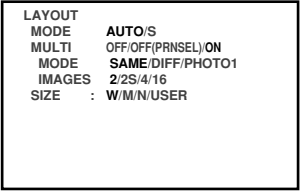

**5 Press ◀ or ▶ button to select an item or change value.**

If you press MENU button, the settings will be cancelled and MAIN MENU is displayed.

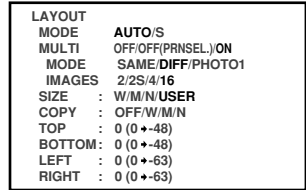

**6 Press SET button.**

“SAVE PRG 1/2/3/CANCEL” is displayed.

This menu lets you select a program memory (1-3) to store your new settings.

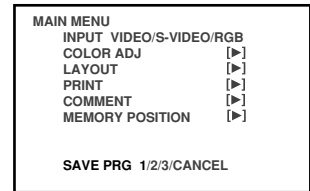

**7 Press ◀ or ▶ button to select the program memory number of 1, 2 or 3 to store the setting.**

The program is replaced. In case of keeping the stored program, do not select the program memory number in which the setting is stored.

If you wish to cancel the setting, select CANCEL and press SET button.

**8 Press SET button again.**

When selecting “PRG1” to set, “1” is chosen. When memorizing in a different program memory number, select the number of the program.

- As the program is replaced, it is recommended not to choose the program number which has been selected in the step 7.
- The memorized program will be selected by pressing PROG button, and the image which follows each setting is displayed. However, you cannot change the setting of selected program during printing. You can store only 1 kind of program set in COMMENT menu. The setting values of TOP, BOTTOM, LEFT and RIGHT in LAYOUT MENU can be memorized in each 2, 2S, 4, and 16 of IMAGES.
- The image will be printed according to the selected memory program.

**NOTE**

The settings can be stored in each program number 1 to 3 in MAIN MENU and SERVICE MENU. When selecting the program number in which the setting is stored, the same program numbers of MAIN MENU and SERVICE MENU are automatically selected. (When selecting Program 1 in MAIN MENU, Program 1 in SERVICE MENU is also selected automatically.)

PRECAUTIONS

FEATURES

CONNECTIONS

PREPARATION

PRINTING

ADJUSTMENTS

TROUBLE-SHOOTING

OTHERS

## COLOR ADJ Colour adjustment display

- The colour of the source image and memorized image can be adjusted.

<b>SELECT</b>	Selects colour print or black and white print.
<b>COLOR</b>	Colour print
<b>B&amp;W</b>	Black and white print (The monitor shows in colours.)
<b>BRT</b> (Bright)	Adjusts brightness of the printing image. (The whole image will be adjusted.)
<b>CONT</b> (Contrast)	Adjusts contrast of the printing image. (The image will be adjusted based on the black level.)
<b>R-SUB</b>	Adjusts red-subcontrast of the printing image. Red is added with ► and blue is added with ◀.
<b>G-SUB</b>	Adjusts green-subcontrast of the printing image. Green is added with ► and pink is added with ◀.
<b>B-SUB</b>	Adjusts blue-subcontrast of the printing image. Blue is added with ► and yellow is added with ◀.
<b>CENTER</b>	When pressing ►, the values of BRT, CONT, R-SUB G-SUB and B-SUB will be reset to 0.
<b>CANCEL</b>	Cancels the change of COLOR ADJ and resets to the stored setting.

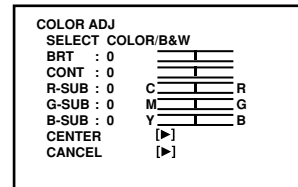

- When selecting B&W, R-SUB, G-SUB and B-SUB change to Y-SUB, M-SUB, C-SUB. When selecting THERMAL : OFF (colour print), each value of Y-SUB, M-SUB and C-SUB is available to adjust the colour of the printed image. When selecting THERMAL : ON (thermal print), only Y-SUB value is available and function as the density of gray colour of the printed image.
- When SELECT is changed from COLOR to B&W, the set values of R-SUB, G-SUB and B-SUB function as the density of gray colour.

## LAYOUT Layout setting display

<b>MODE</b>	Selects the print size. Normally select the ink sheet size which is installed in this unit. (See page 17 for the print paper.)
<b>AUTO</b>	L size ink sheet.
<b>S</b>	When S size ink sheet is installed, S size is automatically set.
<b>L</b>	S size ink sheet or S size printing with L size ink sheet, and S size printing with thermal paper.
	L size printing with thermal paper.
	• When using thermal paper (selecting THERMAL : ON in SYSTEM SETUP menu), AUTO/S is changed to L/S.
<b>MULTI</b>	Selects ON or OFF for printing 2, 4, or 16 images on a sheet.
<b>OFF</b>	Multi-image print is not available. 1 image mode
<b>OFF(PRNSEL.)</b>	4 memory pages display. 1 image mode.
<b>ON</b>	Multi-image print is available.
	• When selecting OFF or OFF(PRNSEL.), MODE: SAME/DIFF/PHOTO1 and IMAGES : 2/2S/4/16 are not displayed.
	• OFF(PRNSEL.) is not available for RS-232C equipment.
	• When setting AUTO CLEAR to MEM or AFT. PRN in OFF(PRNSEL.), only selecting page is cleared.

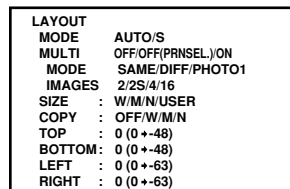

<b>MODE</b>	Selects print mode	
<b>SAME</b>	Prints images of the same scenes on a sheet.	
<b>DIFF (Different)</b>	Prints images of different scenes on a sheet.	
<b>PHOTO1</b>	Prints images in Photo mode.	
	<ul style="list-style-type: none"> <li>This menu is displayed only when MULTI : ON is selected.</li> </ul>	
<b>IMAGES</b>	Selects the number of images on a sheet. Is displayed when setting MULTI to "ON".	
<b>2</b>	2-images on a sheet. (2 S-size images can be printed in L size print. However, the top and bottom of the image will be clipped.)	
<b>2S</b>	2 reduced images on a sheet. (For L size print, the image can be printed without clipping by reducing S size images. In that case, the printing speed(PRN SPEED) becomes NORMAL. For S size print, 2 images can be printed as the same result as 2 mode.)	
<b>4</b>	4-images on a sheet	
<b>16</b>	16-images on a sheet	
	<ul style="list-style-type: none"> <li>2S is not displayed when selecting THERMAL:ON.</li> <li>When selecting "MODE:PHOTO1", the following sizes are available.</li> </ul>	
<b>CARD</b>	Print size	20 mm x 15 mm
<b>3*4</b>	Print size	30 mm x 40 mm
<b>5*5</b>	Print size	50 mm x 50 mm
<b>3*3.5</b>	Print size	30 mm x 35 mm
<b>SIZE</b>	Sets the print area of the image. Choose one from 3 preset print areas and a user select area.	
	Printed image size of 1 image mode(mm)	
	(S size)	(L size)
<b>W</b>	100 x 75	125 x 94
<b>M</b>	94 x 70	118 x 89
<b>N</b>	90 x 68	113 x 85
<b>USER</b>	Optional size by user	
	<ul style="list-style-type: none"> <li>Part of the image may be clipped from the print depending on the print size.</li> </ul>	
<b>COPY</b>	Copys a printed image size which is set W, M, or N in size. The selected setting level is displayed as TOP, BOTTOM, LEFT and RIGHT. These levels become the changing base.	
<b>TOP/BOTTOM/LEFT/RIGHT</b>	Sets the printing area of the image. Adjust the size with ◀ or ▶ button.	
<b>TOP</b>	Shifts the upper end of the image (setting area : 0 to -48)	
<b>BOTTOM</b>	Shifts the lower end of the image (setting area : 0 to -48)	
<b>LEFT</b>	Shifts the left end of the image (setting area : 0 to -63)	
<b>RIGHT</b>	Shifts the right end of the image (setting area : 0 to -63)	

**NOTE**

- When monochrome signal is input, colours may not be added to the characters displayed on the monitor. In that case, set INPUT of ANALOG COLOR ADJ menu to "B&W" in SERVICE MENU.
- When SIZE is set to "W" or the minus value is increased on H-POSI, the monitor screen may get darker according to the monitor connected. However, the image will be printed correctly.

PRECAUTIONS
FEATURES
CONNECTIONS
PREPARATION
PRINTING
ADJUSTMENTS
TROUBLE-SHOOTING
OTHERS



# ADJUSTMENTS & SETTINGS (MAIN MENU)

## PRINT Print setting display

PRINT	
GRAD	ES/ECHO/NOR
APT	S/N/H1/H2
DIR	NOR/REV
MIRROR	OFF/ON
PRN SPEED	FAST/NORMAL

**GRAD** (Gradation) Adjusts the gamma curve of the images.  
 Selects the gamma curve among 3 kinds of the settings.

**ES** Mainly when connecting to endoscope  
**ECHO** Mainly when connecting to ultrasound diagnostic equipment  
**NOR** Mainly when connecting to other equipment

- Only NOR is available when using CK900S4P, CK900L4P, CK900S4P(HX)EU or CK900L4P(HX)EU or selecting THERMAL : ON.

**APT** (Aperture) Controls apertures and reinforces or softens the contour of image.

**S** (SOFT) Softens the contour.  
**N** (NORMAL) Does not perform APT.  
**H1** (HARD 1) Reinforces the contour.  
**H2** (HARD 2) Reinforces the contour more.

**DIR** (Print Direction) Selects printing direction. The left and right margin sizes will be different on L size paper.

**NOR** The margin is made on the lower position.  
**REV** The margin is made on the upper position.

**MIRROR** Selects the mirror (left/right inversed) prints.



**OFF** Normal print  
**ON** Mirror print

**PRN SPEED** (PRINTING SPEED) Sets the printing speed.

**FAST** High speed printing (S size: 1280 dots (100 mm) x 600 lines (75 mm))  
**NORMAL** Prints lines in double density. (S size: 1280 dots (100 mm) x 1200 lines (75 mm))

- Only NORMAL is available when using CK900S4P(HX)EU or CK900L4P(HX)EU or selecting IMAGES : 2S.  
 Only FAST is available when selecting THERMAL : ON.

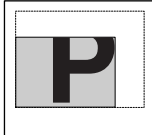
Example of SIZE, DIR and MIRROR setting  
 (This image is limited in printing with white by SIZE setting.)

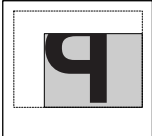
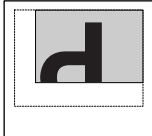
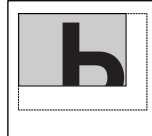
		
Standard print	When the values of TOP and RIGHT are small	When the values of BOTTOM and LEFT are small
		
When the values of TOP and RIGHT are small and MIRROR is ON	When the values of TOP and RIGHT are small and DIR is REV	When the values of TOP and RIGHT are small and MIRROR is ON and DIR is REV

## COMMENT Comment making display

This menu is used to enter a comment.

- Comment mode** Selects to display the comment or not.
  - OFF** Does not display the comment.
  - ON[SET]** Displays the comment.  
When pressing SET button during selecting ON, the editing display will be shown.
  - ADJ** Prints the set value made on APT, COLOR ADJ and ANALOG COLOR ADJ menu.
  - DATA** Prints total number of prints, each setting(AFC, AGC, GRAD, APT), image size, etc.
- Comment display** Displays the comment in this part. 48 letters (24 letters x 2 lines) are available to input. Choose LEFT or RIGHT by ▲, ▼, ◀, ▶ buttons, and select the position to input a letter.
- Character table** Selects the character to input with ▲, ▼, ◀, ▶ buttons.
- Editing mode** Edits the letter and inputting position with ▲, ▼, ◀, ▶ buttons.
  - INS** Select INS and press SET button to insert a space. When the cursor is on a letter, a space is inserted at the cursor position and the letters shift to right.
  - DEL** Select DEL and press SET button to delete the selected letter. The letters shift to left.
  - CANCEL** Select CANCEL and press SET button to go back to the previous comment which has been memorized.
  - SAVE** Select SAVE and press SET button to memorize the comment.

### MAKING A COMMENT

- Select ON with ▶ button and press SET button.**  
The comment editing display appears.
- Select the position where the letter is inputted.**  
Choose LEFT or RIGHT with ▲, ▼, ◀, ▶ buttons, and move the cursor.
- Move the cursor to the character table with ▲, ▼, ◀, ▶ buttons. Then, select a desired letter.**  
The background of the selected letter will turn red.
- Press SET button.**  
The selected letter is inputted into the comment display block.  
The cursor in the comment display block will move to right.

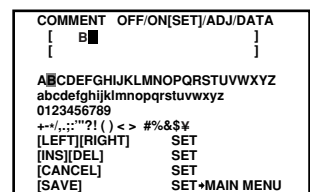
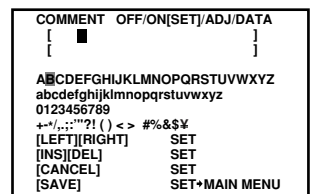
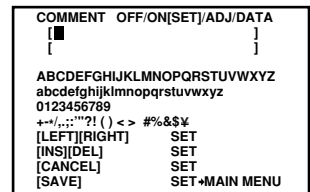
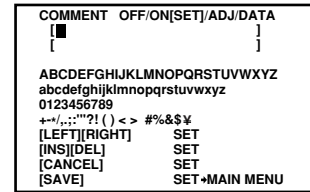

PRECAUTIONS

FEATURES

CONNECTIONS

PREPARATION

PRINTING

ADJUSTMENTS

TROUBLE-  
SHOOTING

OTHERS

## ADJUSTMENTS & SETTINGS (MAIN MENU)

### 5 Repeat steps 2 to 4 to complete a comment.

- Skip 2 if you do not change the cursor position.
- Only one comment can be stored regardless of the program number you chose in SAVE PRG. Same comment will be stored in PRG.1 through PRG3. Different comments cannot be stored in each program.
- When printing in FIELD mode, the comment is a little lower in quality.

### MEMORY POSITION Memory and Position setting display

- The print area settings made with this menu can be memorized as a user program setting.

**LINE** Selects whether a frame of print area is shown or not.

- OFF** A frame of print area is not shown.
- ON** A frame of print area is shown.

- When LINE is set to "ON", the monitor colour may be changed, or the image may become unstable horizontally, depending on the H-POSI setting. In this case, set LINE to "OFF".
- When the frame becomes over the setting area, the frame colour turns black.
- The frame is not displayed on the memory image.

**H-POSI** Changes the horizontal start position of input signal.  
The whole data image can be moved horizontally by changing the setting number.

Setting area -8 - +8

- When setting minus value too large, the right side of the memory image is clipped on the monitor. However, it is printed normally.

**V-POSI** Changes the vertical start position of input signal.  
The whole data image can be moved vertically by changing the setting number.

Setting area -10 - 0

#### H-START (H-Position)

Sets H-Position to special signal timing. Select "FRONT" when the image is unbalanced and cannot be corrected by H-POSI on basic printing. When selecting FRONT, AFC of INPUT menu in SERVICE MENU does not work and the top part of the printing image may curved during VTR special play back.

- NOR(Normal)** When inputting PAL input signal
- FRONT** When inputting special input signal

MEMORY POSITION	
LINE	OFF/ON
H-POSI	0
V-POSI	0
H-START	NOR/FRONT

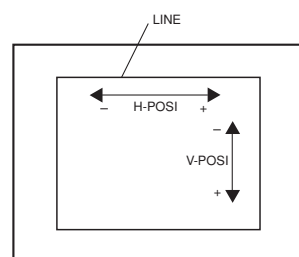

# ADJUSTMENTS & SETTINGS (SERVICE MENU)

## SERVICE MENU ITEMS

SYSTEM	Sets page increment, buzzer and remaining of ink sheet, selects thermal paper.
GAMMA ADJ	Sets gamma curve level.
LAYOUT2&SYSTEM2	Adjusts print layout setting, selects remaining paper checking.
ANALOG COLOR ADJ	Adjusts analog input signal image.
INPUT	Sets even/odd number of FIELD, adjusts display, input signals, etc.
OUTPUT	Sets sub-contrast of the monitor, sync. signal.
KEY SET	Selects the functions of the buttons and function of remote terminal.
RS232C	Selects baud rate.
REMOTE	Selects remote signal.
PREVIOUS ERROR	Shows error history.
SAVE PRG	Stores the above settings in one of 3 program memories

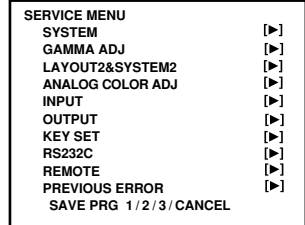

## OPERATING SERVICE MENU

- 1** Press **MENU** button on the remote control unit.  
MAIN MENU is displayed.
- 2** Press **STOP** buttons on the remote control unit at the same time.  
SERVICE MENU is displayed.
- 3** Select your desired item by pressing **▲** or **▼** on the remote control unit.
- 4** Press **▶** button to open a sub menu.
- 5** Select an item you wish to adjust by pressing **▲** or **▼** button.
- 6** Press **◀** or **▶** button to select an item or change value.

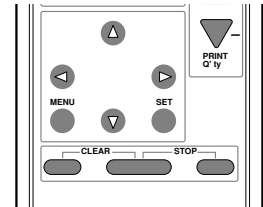

- 7** Press **SET** button.  
SERVICE MENU is displayed.  
"SAVE PRG 1/2/3/CANCEL" is selected.  
This menu lets you select a program memory (1-3) to store your new settings.

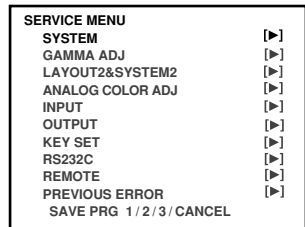

- 8** Press **◀** or **▶** button to select the program memory number of **1**, **2** or **3** to store the setting.  
The program is replaced. In case of keeping the stored program, do not select the program memory number in which the setting is stored.  
If you wish to cancel the setting, select "CANCEL".

(EXAMPLE) Selecting SYSTEM SETUP display

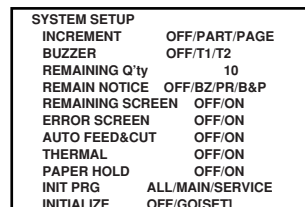

- 9** Press **SET** button.  
When selecting PRG1 to set, "1" is chosen. When memorizing in a different program memory number, select the number of the program.  
The setting is completed and the normal screen is displayed.

PRECAUTIONS

FEATURES

CONNECTIONS

PREPARATION

PRINTING

ADJUSTMENTS

TROUBLE-SHOOTING

OTHERS

## SYSTEM SETUP System setting display

<b>INCREMENT</b>	
<b>OFF</b>	Page increment is not available.
<b>PART</b>	Every time pressing MEMORY button, memory part goes to the next part and image will be memorized on it. The memory page does not go to the next. When MULTI:OFF, this mode works as same as PAGE mode.
<b>PAGE</b>	Every time pressing MEMORY button, memory page goes to the next page and image will be memorized on it.
<b>BUZZER</b>	Selects the buzzer sound when pressing the buttons on the VCP and remote control unit.
<b>OFF</b>	Does not sound the buzzer.
<b>T1</b>	Sounds the buzzer (Tone1).
<b>T2</b>	Sounds the buzzer (Tone2).
<b>REMAINING Q'ty</b>	Sets the number of ink sheet to inform the remaining.
<b>0 - 20</b>	Informs by setting of REMAIN NOTICE when 0 to 20 ink sheet are left.
<b>REMAIN NOTICE</b>	Selects the way to inform when the number of ink sheet is less than the set number in REMAINING Q'ty.
<b>OFF</b>	Does not inform the remaining.
<b>BZ</b>	The buzzer sounds three times when turning on the power, completing printing and closing the door. If the door is open when turning on the power, the buzzer sounds when closing the door.
<b>PR</b>	Informs by printing a red mark under the comment area on the print.
<b>B&amp;P</b>	The buzzer sounds three times and a red mark is printed under the comment area on the print.
	<ul style="list-style-type: none"> <li>When selecting SELECT : B&amp;W in COLOR ADJ, the red mark is printed in black-and-white.</li> </ul>
<b>REMAINING SCREEN</b>	Selects whether displaying the remains of ink sheet on the monitor or not.
<b>OFF</b>	Does not display the remains of ink sheet on the monitor.
<b>ON</b>	Displays the remains of ink sheet on the monitor.
	<ul style="list-style-type: none"> <li>If a paper jam occurs, the remains of the ink sheet may be different from the indication on the monitor.</li> </ul>

<b>SYSTEM SETUP</b>	
INCREMENT	OFF/PART/PAGE
BUZZER	OFF/T1/T2
REMAINING Q'ty	10
REMAIN NOTICE	OFF/BZ/PR/B&P
REMAINING SCREEN	OFF/ON
ERROR SCREEN	OFF/ON
AUTO FEED&CUT	OFF/ON
THERMAL	OFF/ON
PAPER HOLD	OFF/ON
INIT PRG	ALL/MAIN/SERVICE
INITIALIZE	OFF/GO/SET

### NOTE

When THERMAL is set to ON, REMAINING Q'ty, REMAIN NOTICE and REMAINING SCREEN are not displayed.

<b>ERROR SCREEN</b>	Selects whether displaying the error on the monitor.
<b>OFF</b>	When DISPLAY off is selected, the error is not displayed on the monitor.
<b>ON</b>	Even if DISPLAY off is selected, the error is displayed on the monitor.
<b>AUTO FEED&amp;CUT</b>	Selects whether automatically feeding and cutting the print paper or not.
<b>OFF</b>	Does not feed and cut the print paper.
<b>ON</b>	When power is on and setting the print paper, this unit automatically feeds and cuts it twice after closing the front door.
	<ul style="list-style-type: none"> <li>Only OFF is displayed when selecting THERMAL : ON.</li> </ul>
<b>THERMAL</b>	Selects the type of printing paper.
<b>OFF</b>	Colour print paper.
<b>ON</b>	Monochrome thermal paper.
	<ul style="list-style-type: none"> <li>The image may not be printed correctly depending on the set of actual paper type, installation of ink sheet and condition of selecting menu. (Refer to the next page.)</li> <li>When using thermal paper, do not install the ink cassette.</li> </ul>

- PAPER HOLD** Sets to hold the printed paper or not.
- OFF** Printed paper is cut and released.
- ON** Printed paper is held at the print outlet after cut. Pull the paper out when necessary.
- When selecting THERMAL : ON, this menu changes to AUTO CUT.
  - It is recommended not to leave the printed paper holding at the print outlet. Some malfunction may occur.
  - Do not turn off the power while holding paper.
  - When PAPER HOLD is set to ON, MENU button and COLOR ADJUST button on the remote control unit are not available.

- AUTO CUT** Selects cutting the printed thermal paper automatically or not.
- ON** Cuts the printed thermal paper automatically.
- OFF** Does not cut the thermal paper. Press MEMORY button while pressing MONITOR button.
- This menu is displayed only when THERMAL : ON is selected.

- INIT PRG** (Initialize program)
- ALL** Mode to initialize the program in MAIN MENU and SERVICE MENU.
- MAIN** Mode to initialize the program in MAIN MENU.
- SERVICE** Mode to initialize the program in SERVICE MENU.

- INITIALIZE**
- OFF** Does not initialize.
- GO[SET]** Starts initializing. When SET button is pressed, initializing starts.

**Setting and type of print paper / Print result**

Setting	Type of print paper			Colour print paper		Monochrome thermal paper		
	THERMAL	PAPER HOLD	AUTO CUT	MARGIN CUT	With ink cassette	Without ink cassette	With ink cassette	Without ink cassette
OFF	OFF	Not displayed	OFF		Normal colour print	Printing is not available. CHECK CASSETTE *3	Does not print correctly. *3	Printing is not available. CHECK CASSETTE *1
OFF	OFF	Not displayed	ON		Normal colour print with Margin cut			
OFF	ON	Not displayed	OFF		Normal colour print with Paper hold	*1		
OFF	ON	Not displayed	ON		Normal colour print with Paper hold after margin cut			
ON	Not displayed	ON	OFF		Printing is not available.	Does not print correctly. *4	Printing is not available. REMOVE CASS TML *2	Cuts after thermal printing Does not cut after thermal printing
ON	Not displayed	OFF	OFF		REMOVE CASS TML *2			

+1, +2 This error is displayed when turning the power on, and closing the door.  
 +3 In this case, remove the thermal paper and install the colour print paper.  
 +4 In this case, remove the colour print paper and install the thermal paper.

**NOTE**

- When setting THERMAL to OFF after thermal printing with setting AUTO CUT to OFF, "PUSH FEED&CUT5" is displayed on the monitor and LCD. In this case, press MEMORY button with holding MONITOR button to cut the printed paper.
- When selecting AUTO CUT : OFF, make sure to cut the printed paper before turning off the power.

**GAMMA ADJ Gamma level setting display**

- INIT:[CLEAR]** Initializes each setting.
- COLOR** Selects the adjusting gamma level.
- ALL** Adjusting gamma level for all colours.
- EACH** Adjusting gamma level for each colour of R, G, B.
- SELECT** Is displayed when selecting "EACH" in COLOR.
- R** Adjusting gamma level for red.
- G** Adjusting gamma level for green.
- B** Adjusting gamma level for blue.

Changing gamma curve:  
 Use the ▲, ▼ buttons on the remote control unit to select the Hi/Mid/Low gamma point to set.  
 Also Use ◀, ▶ buttons to input setting level.

```
GAMMA ADJ INIT : [CLEAR]
COLOR ALL/EACH
SELECT R/G/B
Hi 0
Mid 0
Low 0
POINT 64 128 192
```

# ADJUSTMENTS & SETTINGS (SERVICE MENU)

**Hi/Mid/Low POINT(Hi/Mid/Low)** Adjusts the colour depth of image by selected point. Selects the point to adjust the colour depth.  
 (EXAMPLE) Pointing lighter colour much lighter;  
 Set the setting level for POINT(Hi) and Hi higher.

**NOTE**

It takes time to set the gamma value by CPU. Wait until the normal display is shown after pressing SET button.  
 It may also take time to switch the program when the value of gamma setting is changed.

## LAYOUT2&SYSTEM2 Layout and system setting display 2

**PRN V AREA** Adjusts the vertical position of memory image.  
 Setting area -10 to 10 (adjusts 2 lines each)

- This menu is displayed only when IMAGES is set for 2 in L size paper.
- PRN V AREA permits adjustment of the vertical position of the image so that the clipped part of the image can be moved higher and lower.

**SEPARATE OFF** Selects whether a white frame is added to each print or not. Prints without white frame. (A white frame appears according to the settings of LAYOUT.)

**ON** Prints with white frame.

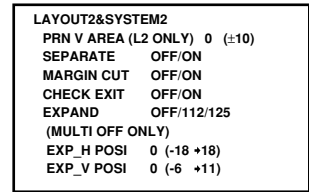

**MARGIN CUT** Cuts the margin of the printed paper.

- This function is very convenient to stick the printed image on the card. The figure shows S size print paper setting.

**OFF** Margin is not cut.  
**ON** Margin is cut.

- Only OFF is displayed when selecting THERMAL : ON.

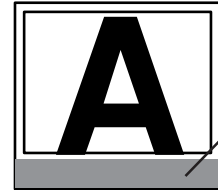

Gray part is cut when MARGIN CUT is ON.

**CHECK EXIT OFF** Selects whether this unit operates paper detecting function when the printed paper is left at the print outlet or not. Does not operate paper detecting function.

**ON** Operates paper detecting function.

- Only OFF is displayed when selecting THERMAL : ON.

**EXPAND OFF** Enlarges the image in the yellow frame on the monitor when printing. Does not enlarge the image. The yellow frame is not displayed.

**112** Enlarges the image by 112.5%.  
**125** Enlarges the image by 125%.

**EXP\_H POSI** Changes the horizontal position of the yellow frame. By changing the value, the yellow frame can be shifted horizontally. Setting range -18 - +18 (When EXPAND is set to 112)  
 -32 - +32 (When EXPAND is set to 125)

**EXP\_V POSI** Changes the vertical position of the yellow frame. By changing the value, the yellow frame can be shifted vertically. Setting range -6 - +11 (When EXPAND is set to 112)  
 -13 - +17 (When EXPAND is set to 125)

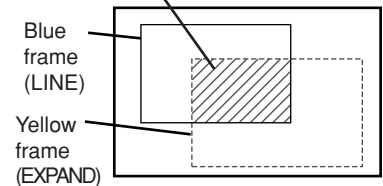
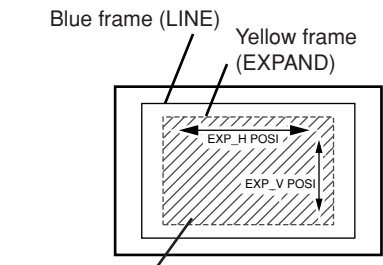

- When MULTI of Layout menu (in MAIN MENU) is set to ON or OFF (PRNSEL.), the image is not enlarged.
- Only the image within both the yellow and blue frames is enlarged and printed at the center of the print paper.
- When LINE of MEMORY POSITION menu (in MAIN MENU) is set to OFF, both the blue and yellow frames are not displayed.
- When EXPAND is set to OFF, EXP\_H POSI and EXP\_V POSI are not displayed.

## ANALOG COLOR ADJ Analog colour adjustment display

- This menu is used to adjust the image of analog input signal before storing in the memory.

**INPUT COLOR B&W** Selects processing of video signal. Processes as colour video signal. Processes as monochrome video signal. (The image is shown in black and white.) Select B&W when inputting monochrome signal.

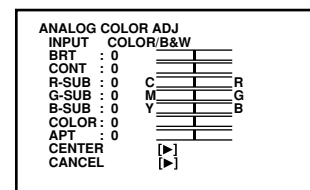



<b>BRT</b> (Bright)	Adjusts the brightness of the printing image.
<b>CONT</b> (Contrast)	Adjusts the contrast of the printing image.
<b>R-SUB</b>	Adjusts red-subcontrast of the printing image. Red is added with ► and blue is added with ◀.
<b>G-SUB</b>	Adjusts green-subcontrast of the printing image. Green is added with ► and pink is added with ◀.
<b>B-SUB</b>	Adjusts blue-subcontrast of the printing image. Blue is added with ► and yellow is added with ◀.
<b>COLOR</b>	Adjusts density of the printing image. The colour of the image gets deeper with ► and lighter with ◀.
<b>APT</b> (Aperture)	Adjusts the contour of image. The contour is reinforced with ► and softened with ◀.
<b>CENTER</b>	Initializes each setting. When pressing ►, the values of BRT, CONT, R-SUB, G-SUB, B-SUB, COLOR, and APT will be reset to the centre value.
<b>CANCEL</b>	Cancels the change of ANALOG COLOR ADJ and resets to the stored setting.

## INPUT Input signal setting display

- Set this menu before memorizing image.

<b>FIELD</b>	The odd and even field lines will be reversed depending on the input interlaced signal. Printing image is not clear so that the odd and even field lines may be reversed depending on the input interlaced signal. In this case, FIELD is set to "REV". (The image disorder cannot be seen in monitor display.)
<b>NOR</b> (Normal)	Does not reverse FIELD as remaining the input interlaced signal.
<b>REV</b> (Reverse)	Reverses the even and odd numbers of FIELD.

### AFC (Automatic frequency control)

The image distortion on the top may occur when the VCR image is special input such as in pause, field-by-field playback, or FF playback mode. Also, the image is not printed correctly because of a weak TV signal. In this case, set the AFC function to "ON".

- The image distortion on the top may occur by the special signal when AFC is set to "ON". In this case, set to "OFF".
- This function menu is invalid when selecting "FRONT" on H-START of MEMORY POSITION in MAIN MENU.

<b>OFF</b>	AFC is invalid.
<b>ON</b>	AFC is available.

### AGC (Automatic gain control)

This function is to automatically adjust a dark picture in brightness and print with sharp contrast. Peak level of an input signal is detected and signal width is standardized to the appropriate value.

<b>OFF</b>	AGC is invalid.
<b>ON</b>	AGC is available.

- This function is not displayed when selecting RGB signal.

### DCF

This function selects whether separating the composite video signal or not. When inputting the monochrome signal, set this function to OFF. Input signal is not through DCF circuit, so that this function is for high quality of monochrome image. When inputting the colour composite signal, this function is set to "ON". Input signal is through DCF circuit and the composite video signal is separated.

<b>OFF</b>	When inputting monochrome signal
<b>ON</b>	When inputting colour signal

- This function is not available when selecting RGB or S-VIDEO.

### IN SYNC

Selects the level of input sync.signal.

<b>TTL</b>	Composite Sync.of TTL level
<b>SOG</b>	Composite Sync.on Green
<b>0.3V</b>	Composite Sync.of 0.3Vp-p level

INPUT	
FIELD	NOR/REV
AFC	OFF/ON
AGC	OFF/ON
DCF	OFF/ON
IN SYNC	TTL/SOG/0.3V

PRECAUTIONS
FEATURES
CONNECTIONS
PREPARATION
PRINTING
ADJUSTMENTS
TROUBLE-SHOOTING
OTHERS



# ADJUSTMENTS & SETTINGS (SERVICE MENU)

## OUTPUT Output signal setting display

- MONI R-SUB** Adjusts red-subcontrast on the monitor. Red is added with ► and blue is added with ◀.
- MONI B-SUB** Adjusts blue-subcontrast on the monitor. Blue is added with ► and yellow is added with ◀.
- LIVE SEL**(Live select) Switches the monitor display routes of input signal at LIVE mode with DISPLAY OFF. Selects to display the image of input signal, or the reflection of image and adjustment on the monitor.
  - ANA**(Analog) Displays the image of input signal on the monitor.
  - DIG**(Digital) Displays the reflection of image and adjustment.
- CONVERT** This function is to output the signal which is selected at INPUT in MAIN MENU to Video output terminal/RGB output terminal/S-video output terminal.
  - OFF** Outputs to the same output terminal as the input terminal.
  - ON** Outputs to Video output terminal/RGB output terminal/S-video output terminal.
- MEMORY SYNC** Selects the Sync. signal for displaying memory image.
  - EXT** Selects external Sync. signal, and displays memory image.
  - INT** Selects internal Sync. signal, and displays memory image.
    - Selecting external Sync. signal may not display memory image correctly depending on the connection. In this case, set SYNC. to "INT".
- OUT SYNC** Selects depending on the output of Sync signal.
  - AUTO** Selects the same signal as the one selected in IN SYNC.
  - USER** Selects by user.
- OUT SYNC** Selects the output level of H+V Sync signal of RGB signal.
  - 0.3V** 0.3 Vp-p
  - TTL** TTL level
- OUT SYNC** Selects the polarity of H+V Sync. output signal of RGB signal. Set the polarity according to the monitor connected. See the operation manual of the monitor for the polarity.
  - NEGA** Negative polarity
  - POSI** Positive polarity
- RGB SOG OUT** Selects the sync.signal output from RGB analog output terminal on the rear panel.
  - OFF** Outputs Composite sync. signal only.
  - ON** Outputs Sync. On Green signal.

OUTPUT	
MONI R-SUB	0
MONI B-SUB	0
LIVE SEL	ANA/DIG
CONVERT	OFF/ON
MEMORY SYNC	EXT/INT
OUT SYNC	AUTO/USER
OUT SYNC	0.3V/TTL
OUT SYNC	NEGA/POSI
RGB SOG OUT	OFF/ON

## KEY SET Button function setting display

- KEY LOCK** Makes the function of the remote control unit buttons invalid.
  - OFF** All buttons on the remote control unit are available.
  - ON** The function on the remote control unit buttons, except MEMORY, PRINT, MONITOR and MEMORY PAGE are not available. When pressing MENU button, KEY SET menu is displayed. When pressing MENU button, only selecting OFF/ON of KEY LOCK is available.

KEY SET	
KEY LOCK	OFF/ON
MEM&PRN	OFF/ON/R1/R2
MEM&STOP	OFF/PART/PAGE
MEM&MONI	OFF/ON
KEEP MONI	OFF/ON
AUTO CLEAR	OFF/MEM/AFT. PRN
CLEAR KEY	PART/PAGE/ALL

## MEM&PRN(Memory and Print)

When pressing MEMORY button, the image is automatically printed after the image is stored in the memory. In case of multi image of different scenes, printing will be done after the last image is stored in memory.

**OFF** MEMORY button functions individually. The image is memorized without printing.

**ON** Automatically prints after memorizing.

**R1** When a signal inputted through a memory key (pin No.2) of the remote terminal on the rear panel is switched to "low" level from "high" for the first time, a memory image is displayed. Then at the second time, a source image is displayed without printing the memory image.

**R2** On the KEEP MONI OFF status, when a signal inputted through a memory key (pin No.2) of the remote terminal is switched to "low" level from "high" for the first time, a memory image is displayed. Then at the second time, a source image is displayed and the memory image is printed. Do not change MULTI setting after memorizing an image.

## MEM&STOP(Memory and Stop)

**OFF** The next image is overlaid in the memory.

**PART** The next image can not be overlaid in the memory when all parts of a page become full. To overlay a new image, print the memorized image.

**PAGE** The next image can not be overlaid in the memory when all pages become full. To overlay a new image, print the memorized image.

## MEM&MONI(Memory and Monitor)

Switches the monitor display between the source image and memory image after memorizing.

**OFF** Displays the source image.

**ON** Displays the memory image.(Initial setting)

- When KEEP MONI is set to OFF, the source image will be displayed when starting printing.

**KEEP MONI** Selects the image displayed on the monitor during printing.

**OFF** Displays the source image after starting printing.

**ON** Displays the source image after starting printing, when indicating it before printing. Displays the memory image after starting printing, when indicating it before printing.

## AUTO CLEAR

**OFF** The printed memory image is not cleared.

**MEM** When MULTI is set to ON, the memory image is cleared after memorizing on the printed memory page again.

**AFT. PRN** The printed memory image is cleared after completing printing.

- For continuous printing, the stored image are cleared by above settings after completing printing of set number of print.

## CLEAR KEY

**PART** Pressing CLEAR button on the remote control unit, the selected one MULTI image is cleared.

**PAGE** Pressing CLEAR button on the remote control unit, images of the memorized page being selected are cleared.

**ALL** Pressing CLEAR button on the remote control unit, all of the stored images are cleared.

## R1

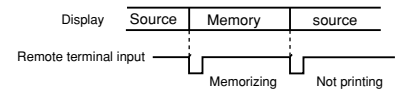

## R2 (When KEEP MONI :OFF)

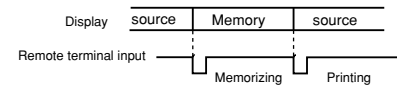

## MEM&MONI : OFF

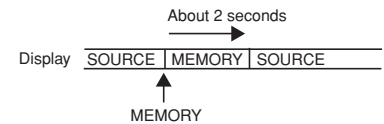

## MEM&MONI : ON KEEP MONI : OFF

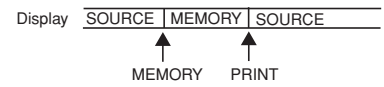

## MEM&MONI : ON KEEP MONI : ON

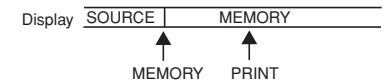

PRECAUTIONS

FEATURES

CONNECTIONS

PREPARATION

PRINTING

ADJUSTMENTS

TROUBLE-SHOOTING

OTHERS

## RS232C SET RS-232C signal setting display

- This menu does not work when selecting THERMAL:ON or MULTI : OFF(PRNSEL.).

**BAUD RATE** Set the baud rate of RS-232C.  
Set the baud rate according to the connecting device.

**COMMAND TYPE** Sets the command type of RS-232C.  
Selects the command type of RS-232C to control this unit.

- Select "A" for normal setting. Depending on the connected equipment, select "B" or "C".

**RESPONSE** Selects whether this unit sends RS-232C response to the host computer or not.

- OFF** Does not send response.
- ON** Sends normal response.

**ERR RES OK** Selects the response code when an error occurs.

- NOR** Sends the regular response.
- ILL** Sends "job end" even if ILLEGAL error occurs.
- INV** Sends "job end" even if INVALID error occurs.
- ALL** Sends "job end" when any error occurs.

**NO DSR** Sets to use 232C, DSR and DTR.  
Sets "NO DSR" according to the connecting device.

- OFF** Uses NO DSR.
- ON** Does not use NO DSR.

RS232C SET	
BAUD RATE	1.2/2.4/4.8/9.6k
COMMAND TYPE	A/B/C
RESPONSE	OFF/ON
ERR RES OK	NOR/ILL/INV/ALL
NO DSR	OFF/ON

## REMOTE SET Remote signal setting display

**BUSY LEVEL** Selects the level of BUSY signal from the remote terminals 1 and 2 on the rear panel.

- LOW** The VCP cannot accept the remote input signal when the signal is "LOW".
- HIGH** The VCP cannot accept the remote input signal when the signal is "HIGH".

- The default setting is "HIGH".

**BUSY 1,2 SELECT** Selects when the BUSY signal is outputted from the remote terminals 1 and 2 on the rear panel.

- PRINTING** Outputs BUSY signal during printing.
- MECHA ERR** Outputs BUSY signal when a mechanical error occurs in this unit or IC chip is not installed. BUSY signal is also outputted when the printing mechanism is pulled out or the menu is displayed on the monitor.
- MEDIA ERR** Outputs BUSY signal when an error for paper or ink sheet occurs.
- MEMORY STOP** Outputs BUSY signal when MEMORY button is not functioning.
- STROBE 1V** After outputting BUSY signal, memory is taken in by waiting to 1 vertical period.
- STROBE 2V** After outputting BUSY signal, memory is taken in by waiting to 2 vertical periods.
- REMAINING** Outputs BUSY signal while the remains of ink sheet becomes the value set in REMAINING Q'ty.

- When either STROBE 1V or STROBE 2V is set to OFF, the other is available for setting.

REMOTE SET	
BUSY LEVEL	LOW/HIGH
BUSY1,2 SELECT	
PRINTING	OFF/1/2/1&2
MECHA ERR	OFF/1/2/1&2
MEDIA ERR	OFF/1/2/1&2
MEMORY STOP	OFF/1/2/1&2
STROBE 1V	OFF/1/2/1&2
STROBE 2V	OFF/1/2/1&2
REMAINING	OFF/1/2/1&2

## ■ SYNCHRONOUS SETTING FOR MEMORY

STROBE : 1V, BUSY LEVEL: HIGH in REMOTE SET of SERVICE MENU

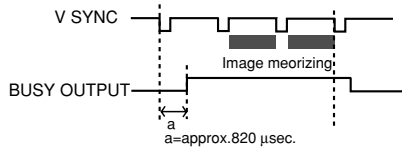

STROBE : 2V, BUSY LEVEL: HIGH in REMOTE SET of SERVICE MENU

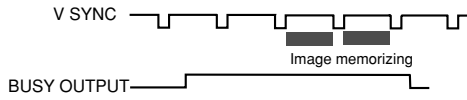

The numbers in the above figures are just references. The timing may be different according to the setting.

## PREVIOUS ERROR Error display

This function displays the most recent types of error.

PREVIOUS ERROR

NO ERROR  
NO ERROR  
NO ERROR  
NO ERROR

PRECAUTIONS

FEATURES

CONNECTIONS

PREPARATION

PRINTING

ADJUSTMENTS

TROUBLE-  
SHOOTING

OTHERS

# ERROR MESSAGES & COUNTERMEASURES

## ERROR MESSAGES

If for some reason printing is not possible or error occurs during printing, the error message will be displayed on the monitor screen or LCD.

In this case, follow the procedure described below.

Error messages	Causes	Countermeasures
DOOR OPEN	The printing mechanism is not locked completely.	• Insert the printing mechanism until it is locked in the unit.
CHANGE PAPER	Paper is used up.	• Set a new roll of paper. Refer to pages 17-18. *Note : 1
CHANGE INK	The ink sheet is used up.	• Replace the ink sheet with a new one. Refer to pages 18-19.
SET CASSETTE CHECK CASSETTE	The ink cassette is not installed.	• Install the ink cassette. Refer to pages 18-19.
REMOVE CASS TML	Ink cassette is installed when selecting THERMAL :ON.	• Remove the ink cassette.
SET PAPER	Paper is not installed.	• Set paper correctly.
OVER HEAT	The temperature of the thermal head becomes too high.	• Wait until the message goes off. *Note : 2
CHECK INK 1* (*: 1 - 7)	IC chip is not installed. The data in IC chip cannot be read correctly.	• Use an ink sheet with the attached IC chip. • Set the attached IC chip on an ink sheet. • Use the correct ink sheet with IC chip.
CHECK INK 4	IC chip and the ink mark are not the same. A wrong media type is set.	• Use correct IC chip and ink sheet.
REMOVE PAPER 11 REMOVE PAPER 12 REMOVE PAPER 13	Paper jam occurs. Paper jam occurs when selecting THERMAL:ON.	• Refer to page 57 "Overcoming paper jams". Press MEMORY button for more 1 second while pressing the MONITOR button. *Note :3
CHECK EXIT *Note : 4	Paper is left in the paper outlet.	• Remove the paper.
MECHA ERROR 20 MECHA ERROR 30 MECHA ERROR 40	Other defects.	• Press MEMORY button for more 1 second while pressing the MONITOR button. *Note :3 In case of paper jam, refer to page 57 "Overcoming paper jams". If the status is not improved by carrying out this measure, consult your dealer.
OTHERS	Other defects.	• Consult your dealer.

\*Note : 1 The image may not be printed completely.

\*Note : 2 When setting the continuous printing, the continuous printing is carried out after the error message goes off.

\*Note : 3 This is an operation for initialization. **Make sure to press the MONITOR button first.** If MEMORY button is pressed first, a new image will be stored in memory erasing any previously stored image.

\*Note : 4 During error status, the buzzer keeps sounding.

### Other messages

Messages	Causes and countermeasures
PUSH FEED&CUT	Indicated when the power is turned on after turning off during printing. Press MEMORY button for more than one second while pressing MONITOR button. This is initializing. <b>Make sure to press MONITOR button first.</b>
MECHA INITIALIZE	Indicated during initializing.
PRINT STOP	In the case of pressing STOP button on the remote control during printing, this unit is initialized. This message is indicated during initializing.

### NOTE

- FEED&CUT (paper feeding and cutting) may not work when "PUSH FEED&CUT\*" or "MECHA ERROR\*" is displayed. In this case, pull the printing unit out to remove the print paper and re-install it. Then, close the printing unit and press MEMORY button while pressing MONITOR button again.
- If turning off the power during printing or stand-by, and turn on the power again with THERMAL : ON and AUTO CUT : OFF, "PUSH FEED&CUT\*" is displayed. In this case, make sure to remove the printed part with scissors etc, and press MEMORY button while pressing MONITOR button to feed & cut.

## BEFORE CALLING FOR SERVICE

- Use the following troubleshooting chart to try to resolve any apparent defect in operation. If you are unable to resolve the problem, unplug the power cord and contact your dealer.

Symptom	Check and Remedy
No power (when POWER lamp does not illuminate)	Is the power cord plug disconnected from the outlet? →Connect the power cord plug to the outlet firmly. After tuning the power off, wait for approx. 2 minutes. Then turn on the power.
No image appears on the monitor.	Are the IN SYNC, the OUT SYNC and the RGB SOG OUT set correctly? →Check the current setting. Refer to pages 11-16. Are the video signal and sync. signal inputted to this unit? →Check the connection. Refer to pages 11-16. Is the input signal (INPUT : VIDEO, S-VIDEO, RGB) selected on the menu screen correctly? →Check the current setting. Refer to pages 22-23. Is the image stored in memory displayed on the monitor screen? →Press MONITOR button to display the source image (LIVE).
The image on the monitor screen vibrates when characters are indicated on the monitor screen or LIVE SEL is set to "DIG". Refer to page 49.	Are the sync. polarity of the monitor (OUT SYNC: NEGA POSI), the output level of the sync. signal (OUTPUT SYNC) and the RGB output sync. signal (RGB SOG OUT) set correctly? →Check the current setting. Refer to pages 11-16.
The image is not stored in memory.	Are the images being printed with full memorized memory page? →Press the CLEAR button on the remote control unit after printing. Then, store the image in the memory again. Is the memory full in the status of "INCREMENT : OFF" or "AUTO CLEAR : OFF"? →Store the image in the memory after pressing the CLEAR button on the remote control unit. (According to the setting conditions, the image can be stored in the memory by setting INCREMENT to "PART" or "PAGE", AUTO CLEAR to "AFT. PRN" or pressing the PRINT button.) Is the memory full in the status of "MEM & STOP : ON"? →Press CLEAR button on the remote control, and store the image again.
The image is not printed.	Is the image stored in memory? →Confirm that the image is stored in memory. Is the print paper or ink sheet used up? →Check the status. Is the printing mechanism set correctly? →Set the printing mechanism correctly.

PRECAUTIONS
FEATURES
CONNECTIONS
PREPARATION
PRINTING
ADJUSTMENTS
TROUBLE-SHOOTING
OTHERS

## ERROR MESSAGES & COUNTERMEASURES

### Symptom

### Check and Remedy

The stored image in the memory cannot be enlarged to fill the maxim print area.

Is the S size ink sheet installed when selecting "S" in MODE : AUTO/S? Or is the L size ink sheet installed when selecting "AUTO" in MODE : AUTO/S?  
→ Check the current setting. Refer to pages 23-24.  
Is the paper size set to "N" in the size setting in LAYOUT menu?  
→ Set the size to "M" or "W". Refer to pages 34, 41.  
Is the print area set correctly in LAYOUT menu?  
→ Check the setting of the print area. Refer to pages 40-42.

The colour or picture quality is different between the memorized image and the printed image.

Is the colour of the image stored in the memory adjusted?  
→ Adjust the colour of the image stored in the memory with Colour adjustment display (COLOR ADJ). Refer to page 40.

When inputting monochrome image signal (without burst signal), sync. becomes unstable.

Is INPUT in ANALOG COLOR ADJ set to "COLOR"?  
→ Set INPUT to "B&W". Refer to page 48.

The colour or picture quality is different between the image on the monitor screen and the printed image. (When the colour and picture quality are same between the image stored in the memory and the printed image.)

Is the image on the monitor screen adjusted?  
→ Adjust the image on the monitor screen with "MONI R-SUB" and "MONI B-SUB" in the OUTPUT menu.  
Refer to page 50.

The set comments do not appear on the print paper.

Is the COMMENT set to "OFF"?  
→ Set COMMENT to "ON". Refer to page 43.  
Is the comment inputted?  
→ Input the comment on the menu. Refer to pages 43-44.

Wired remote control unit cannot be operated.

Is the plug of the remote control unit disconnected from its terminal on the unit?  
→ Connect the plug of the remote control unit to the REMOTE terminal on the unit.  
The supplied remote control unit can not be used by connecting to the external remote terminal on the rear panel of this unit.  
Is the wired remote control unit for this unit (accessory) used?  
→ Use the remote control unit for this unit.  
Is PAPER HOLD set to "ON", and is printed paper kept at the print outlet?  
→ Remove the printed paper from the print outlet.  
Is KEY LOCK set to "ON"?  
→ Set KEY LOCK to "OFF".

The printing unit cannot be opened.

Is the paper cut after printing with THERMAL : ON and AUTO CUT : OFF?  
→ Press MEMORY button while pressing MONITOR button to cut the printed paper.

"CHECK EXIT" message is displayed though the printed paper is not left at the paper outlet.

The sensor for detecting remaining paper may fail to work properly due to infrared light and so on.  
→ Set CHECK EXIT of LAYOUT2&SYSTEM2 in SERVICE MENU to "OFF".

## OVERCOMING PAPER JAMS

### 1 Press OPEN button to pull out the printing mechanism.

When it is not working, turn off the power once. Then try to press OPEN button again.

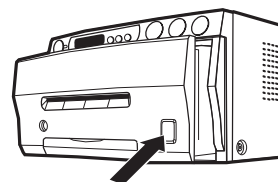

### 2 Remove the ink cassette with ink sheet.

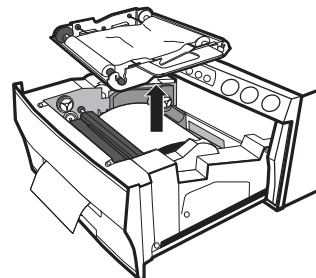

### 3 Remove the print paper as shown right.

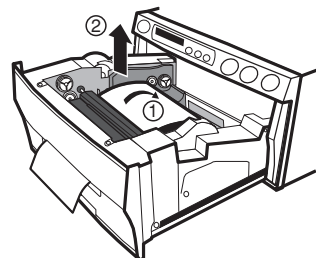

### 4 Cut the defective part of the print paper with scissors.

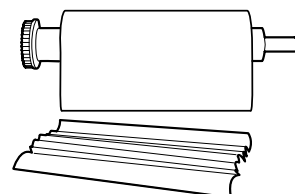

### 5 Cut both edges of the print paper.

### 6 Install the print paper. (Refer to pages 17-18.)



#### NOTE

To feed the print paper, press MEMORY button while pressing MONITOR button. When carrying out this procedure, make sure to press MONITOR button first. If MEMORY button is pressed first, a new image will be stored in memory and the previously memorized image will be erased.

PRECAUTIONS

FEATURES

CONNECTIONS

PREPARATION

PRINTING

ADJUSTMENTS

TROUBLE-  
SHOOTING

OTHERS



## CLEANING

Cleaning as indicated below will help maintain stable printer operation and extend the printer's life.

### Preparations

- Alcohol (isopropyl alcohol)
- Tissue paper (Fold in half about 4 times, and use the folded side to clean.)
- Cotton buds
- Cleaning kit (Option)\*

Other : Cleaner pen (Option)\*

\*Please ask the dealer about options.

Make sure to turn off the power before cleaning.

**1 Press OPEN button to pull the printing mechanism out.**

**2 Remove the ink cassette and print paper.**

**3 Wipe the ink sheet sensor.**

Clean the parts circled in the right figure.

Wipe with tissue paper etc. which is soaked in a small amount of alcohol carefully.

**4 Wipe the ink sheet sensor reflection plate.**

Clean the metal reflection plate.

Wipe with tissue paper etc. which is soaked in a small amount of alcohol carefully.

**5 Wipe the head.**

Cleaning the part under the thermal head which develops heat.

Wipe the head cleaning part carefully with tissue paper etc. which is soaked in a small amount of alcohol.

### NOTE

- Do not damage the thermal head.
- When the symptom of the poor print quality is not corrected even if the head is cleaned, replacing the thermal head is required. Contact your dealer.
- Thermal head is hot right after printing. Wait until the head temperature is low when cleaning the thermal head.

**6 Clean the rubber roller.**

The seal paste and dust etc. are stuck on the rubber roller if you use it for a long time.

Wipe with tissue paper etc. which is soaked in a small amount of alcohol carefully.

A small amount of alcohol



Cleaning part

How to hold tissue paper

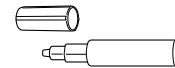

Cleaner pen (Option)

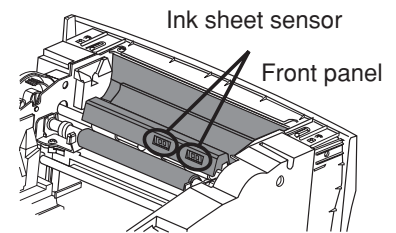

Ink sheet sensor

Front panel

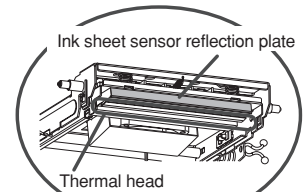

Ink sheet sensor reflection plate

Thermal head

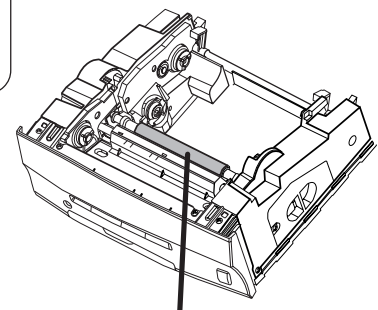
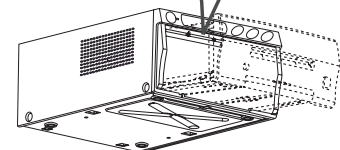

Rubber roller

# SPEC & OPTIONS

## SPECIFICATIONS

Class	Colour Video Copy Processor		
Model	CP900E		
Printing method	Sublimation Dye Thermal 3 colour faces progressive printing (yellow, magenta and cyan) and surface lamination		
Print quality	Dot resolution	Max. 1280 x 600 pixels (S size / FAST mode)	
	Number of grades	256 (8 bits) for each colour ( About 16.7 million colours)	
Printing time*	L size	Approx. 22 sec./sheet (When using CK900L / 1-image/FAST mode)	
	S size	Approx. 12 sec./sheet (When using CK900S / 1-image/FAST mode)	
Ink sheet	Special cartridge method		
Print paper (1 image mode)	<u>Special roll paper</u>		<u>L size 160 x 110mm</u>
	Printing area	Wide mode	125 x 94mm
		Middle mode	118 x 89mm
		Narrow mode	113 x 85mm
	<u>Special roll paper</u>		<u>S size 110 x 105mm</u>
	Printing area	Wide mode	100 x 75mm
Middle mode		94 x 70mm	
Narrow mode		90 x 68mm	
Supply method	Automatic (roll paper)		
Input terminal	RGB analog (4 BNC type connectors)		
	Composite video (1 BNC type connectors)		
	S-VIDEO (1 S-VIDEO terminal)		
Output terminal	RGB analog (4 BNC type connectors)		
	Composite video (1 BNC type connectors)		
	S-VIDEO (1 S-VIDEO terminal)		
Input/Output terminal	RS-232C (D-SUB 25 pin)		
	Remote terminal (Mini Din 8 pin, stereo mini jack)		
Input frequency	H frequency 15.75 kHz		
	V frequency 50Hz		
Power supply	AC 220-240V, 50Hz		
Power consumption	1.2A (AC220-240V, 50Hz) during printing (0.3A when not printing)		
Installation conditions	Temperature :	5°C - 40°C (41°F - 104°F)	
	Humidity :	20% - 80% RH (No dewing)	
Operation altitude	Within Horizontal $\pm 5^\circ$		
Outside dimensions	280(W) x 150(H) x 400(D) mm		
Weight	11kg		
Accessories	Power cord (1), Ink cassette (1), Operation manual (1), Remote control unit(1), Spacer (4), Screw(4), Attachments for thermal paper (1 set)		

\*Printing time : time between pressing PRINT button and sounding buzzer which informs the print end

## OPTIONS

### PAPER SHEET SET

Product name	Ink sheet size	No. of prints	Usage
CK900S	S size	200	Colour print
CK900L	L size	130	Colour print
CK900S4P	S size	130	Surface-laminated colour print
CK900L4P	L size	90	Surface-laminated colour print
CK900S4P(HX)EU	S Size	130	Surface-laminated colour print for ID photo
CK900L4P(HX)EU	L Size	90	Surface-laminated colour print for ID photo

### THERMAL PAPER

Product name	Print size	No. of prints	Usage
KP65HM-CE	S/L size	S size Approx. 200 L size Approx. 125	Thermal print

### PAPER INK SHEET CASSETTE

Product name	Ink sheet size	No. of prints	Usage
PKC900S	S size	200	Colour print
PKC900L	L size	130	Colour print

PRECAUTIONS

FEATURES

CONNECTIONS

PREPARATION

PRINTING

FUNCTIONS

TROUBLE-SHOOTING

OTHERS



**Mitsubishi Electric Europe B.V.**

**UK Branch**

Travellers Lane, Hatfield, Herts. AL10 8XB, England, U.K.  
Phone +44 (0) 1707 276100 FAX +44 (0) 1707 278755

**German Branch**

Gothaer Strasse 8, 40880 Ratingen ; Postfach 1548, 40835 Ratingen ; Germany  
Phone +49 (2102) 486-9250 FAX +49 (2102) 486-7320

**French Branch**

25, Boulevard des Bouvets - 92741 NANTERRE cedex  
Phone +33 (1) 55 68 55 00 FAX +33 (1) 55 68 57 31

**Italian Branch**

Centro Direzionale Colleoni, Palazzo Perseo-Ingresso 2,  
Via Paracelso 12, 20041 Agrate Brianza, (Milano) Italy  
Phone +39 03960531 FAX +39 0396053214

**Benelux Branch**

Nijverheidsweg 23a,  
3641 RP Mijdrecht, Nederland  
Phone +31 (0) 297-282461 FAX +31 (0) 297-283936

**Spanish Branch (Barcelona)**

Ctra. de Rubí, 76-80 - Apdo. 420  
08190-Sant Cugat del Vallés - (Barcelona) Spain  
Phone +34 93 565 3154 FAX +34 93 589 4388

Manufactured by Mitsubishi Electric Corporation  
1 Zusho Baba, Nagaokakyo-city, Kyoto Japan