

CUTTING PLOTTER

CG-EX Series

CG-60EX

CG-100EX

CG-130EX

OPERATION MANUAL

MIMAKI ENGINEERING CO., LTD.

TKB Gotenyama Building, 5-9-41, Kitashinagawa, Shinagawa-ku, Tokyo 141-0001, Japan

Phone: +81-3-5420-8671 Fax: +81-3-5420-8687

URL: <http://www.mimaki.co.jp>

FOREWORD

Thank you for purchasing a MIMAKI “CG-EX Series” model of cutting plotter.

This operation Manual describes how to handle and operate the “CG-60EX/100EX/130EX” model of cutting plotter (hereinafter called the “Device”).

Please read and fully understand this Operation Manual before putting the machine into service.

It is also necessary to keep this Operation Manual on hand.

REQUESTS

- This Operation Manual has been carefully prepared for your easy understanding, however, please do not hesitate to contact a distributor in your district or our office if you have any inquiry.
- Description contained in this Operation Manual are subject to change without notice for improvement.
- In the case where this Operation Manual should be illegible due to destruction by fire or breakage, purchase another copy of the Operation Manual from our office.

PRECAUTIONS

Be sure to follow the below-stated precautions when using the device.

Safety precautions

Thoroughly read this Operation Manual to avoid danger.

Be sure to carefully read this Operation Manual, fully understand the description and make yourself familiar to the operation of the device so as to ensure safe use of the device.

Limited application

The device is intended to be used for cutting sheets (PVC sheets, fluorescent sheets, reflective sheets, etc.) and plotting and pouncing on drawing paper. Never use the device in any application other than the aforementioned intended ones.

Clothes to be worn in work

Never worn clothes that can interfere with your work (such as loose-fit clothes and accessories). In addition, bind your hair, if long.

Precautions in use

- * Keep away from a grid roller while it is rotating.
A rotating grid roller can be so hazardous to your person as to abrade fingertip skin or tear off fingernails, if touched.
- * While the device is engaged in cutting (plotting), keep head and hands away from any moving part of the device.
A moving part of the device can catch hair or cause accidental injuries, if approached.
- * Never swing a cutter to avoid danger.
Blade can project from the cutter, if swung.
- * Do not return on the power to the device once you have cut it off.
Once you have cut off the power to the device, return it on after a lapse of 30 seconds or more.
- * Do not store the device with its pinch rollers lowered.
Be sure to raise the pinch rollers whenever the machine is not in operation. If the machine is left unused with its pinch rollers lowered, the pinch rollers can be form and fail to retain sheets.

Precautions regarding a setup location

Never install the device at any of the following locations.

The locations can adversely affect the device, impairing the cut quality or giving rise to failures.

- * A place exposed to direct sunlight
- * A place in which temperature and humidity vary by a great margin
Operating environment: 5 to 35°C
35 to 75% (Rh)
With no dew condensation
- * A place exposed to direct air blow from air conditioner, etc.
- * A place filled with dirt, dust or tobacco smoke
- * A place that considerably vibrates

Safety labels

The device is adhered with a safety label that informs the customer of possible risks associated with the device.

Be sure to understand the correct meaning of the safety label to avoid danger.

If the safety label is illegible due to stains or has come off, purchase a new one from our sales office.

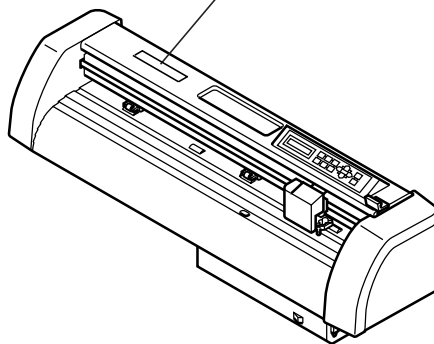
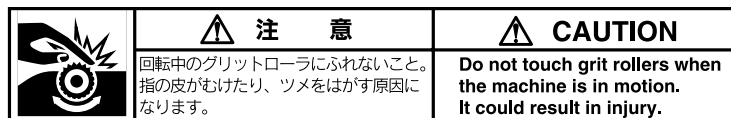

HOW TO USE THE OPERATION MANUAL

About this Operation Manual

■ Signs and symbols

For the purpose of this Operation Manual, the below-stated signs are attached to important items and helpful descriptions to be remembered to prevent possible accidents and troubles and to make the most out of the device.



This represents a caution.

It is attached to items and descriptions given to warn the customer against possible risks of personal injury, failures of the device or incorrect data.



This represents a hint.

It is attached to items and descriptions given to help the customer for better results.

■ Display panel/keys

The display panel and keys appear in the below-stated style.

Display	<div style="border: 1px solid black; padding: 5px; display: inline-block; margin-bottom: 10px;">SET UP <ENT></div> <p>This represents the description shown on the display panel of the device. For the purpose of this volume, it is given in brackets as [SET UP].</p> <div style="border: 1px solid black; padding: 5px; display: inline-block; margin-bottom: 10px;">CENTER ORIGIN</div> <p>In such a case as to enter a setting, the cursor location flashes on and off on the display panel. For the purpose of this volume, the cursor location that flashes on and off is given with crosshatched.</p>
Key	<p>Keys are represented as given below both in the illustrations and the text.</p> <div style="display: flex; flex-wrap: wrap; justify-content: space-around; align-items: flex-start;"> <div style="border: 1px solid black; padding: 2px; margin: 2px;">DATA CLEAR</div> <div style="border: 1px solid black; padding: 2px; margin: 2px;">FUNCTION</div> <div style="border: 1px solid black; padding: 2px; margin: 2px;">END</div> <div style="border: 1px solid black; padding: 2px; margin: 2px;">ENTER HOLD</div> <div style="border: 1px solid black; padding: 2px; margin: 2px;">AUTO FEED</div> <div style="border: 1px solid black; padding: 2px; margin: 2px;">TOOL SELECT</div> </div> <div style="display: flex; flex-wrap: wrap; justify-content: space-around; align-items: flex-start; margin-top: 5px;"> <div style="border: 1px solid black; padding: 2px; margin: 2px;">REMOTE LOCAL</div> <div style="margin: 2px;">◀</div> <div style="margin: 2px;">▶</div> <div style="margin: 2px;">▲</div> <div style="margin: 2px;">▼</div> </div>

Structure of this Operation Manual

Chapter 1 Set-up

This chapter describes the configuration of the accessories and main unit of the device, the procedures to be taken to set up the device and the procedures to be taken to connect the cables.

Chapter 2 Basic operation and settings

This chapter describes steps of procedures to be followed from turning on the power to the device through cutting (plotting) and settings to be established according to the basic operating procedures.

Chapter 3 Explanation of functions

This chapter gives explanation of functions of the device and corresponding methods to operate them.

Chapter 4 In case of trouble

This chapter describes how to correct troubles in the even that abnormal conditions are encountered.

Appendix

This appendix describes the replacement of blades, output samples and specifications of the main unit of the device.

TABLE OF CONTENTS

FOREWORD	i
PRECAUTIONS	ii
Safety precautions	ii
Precautions in use	ii
Precautions regarding a setup location	iii
Safety labels	iii
HOW TO USE THE OPERATION MANUAL	iv
About this Operation Manual	iv
Structure of this Operation Manual	v
CHAPTER 1 SET-UP	1. 1
Checking the accessories	1. 2
CONFIGURATION OF THE MAIN UNIT (CG-60EX)	1. 4
Front of the main unit	1. 4
Rear of the main unit	1. 4
CONFIGURATION OF THE MAIN UNIT (CG-100EX/130EX)	1. 6
Front of the main unit	1. 6
Rear of the main unit	1. 6
ATTACHING THE ROLL HANGERS (CG-60EX)	1. 8
ASSEMBLING THE MAIN UNIT AND STANDS (CG-100EX, 130EX)	1. 9
Attached the roll stays to the stands	1. 11
CONNECTING THE CABLES	1. 12
CHAPTER 2 BASIC OPERATIONS AND SETUPS	2. 1
OPERATION PANEL	2. 2
Jog keys	2. 3
BASIC OPERATION OF THE KEYS	2. 4
BASIC PROCEDURE FOR OPERATING THE DEVICE	2. 7
TURNING THE POWER ON	2. 8
Operation modes	2. 9
ATTACHING A TOOL	2. 10
Adjusting the blade tip of the cutter	2. 10
Attaching a tool	2. 11
TOOL CONDITIONS SETTING	2. 12
LOADING A SHEET OF MEDIA	2. 14
Maximum cutting area	2. 14
Pinch rollers and grid rollers	2. 15

Travel range of pinch rollers 1 and 2	2. 15
Selecting the clamp force	2. 17
Loading a leaf sheet	2. 18
Loading a roll sheet (CG-60EX)	2. 19
Loading a roll sheet (CG-100EX, 130EX)	2. 21
Sheet detection	2. 24
STARTING CUTTING (PLOTING)	2. 26
Setting an origin	2. 26
Starting cutting (plotting)	2. 27
Putting the cutting (plotting) on hold	2. 27

CHAPTER 3 EXPLANATION OF FUNCTIONS 3. 1

LISTING OF FUNCTIONS	3. 2
Functions invoked with the jog keys (arrow keys)	3. 2
Functions invoked with specific keys	3. 2
Functions	3. 2
Operation of keys corresponding to the functions	3. 4
EXPLANATION OF FUNCTIONS	3. 8
Cutting area	3. 8
Two-point axis alignment	3. 8
Paper cut	3. 9
Digitization operation	3. 9
Data clear	3. 10
Sheet feed	3. 10
Hold	3. 11
Half cut	3. 11
No. of copies [No. COPIES]	3. 13
Test cutting [SQUARE]	3. 14
Distance compensation [DIST. COMP]	3. 14
Sample cut [SAMPLE CUT]	3. 17
Execution of dump [DUMP]	3. 17
Execution of list output [LIST]	3. 17
DISPLAY	3. 18
Setting communication conditions [INTERFACE]	3. 18
Change-over of cut mode [CUT MODE]	3. 19
Rotation [ROTATION]	3. 20
Division cut [DIVISION CUT]	3. 21
POUNCING [POUNCING]	3. 24
Command priority setting [PRIORITY]	3. 24
Remote display [REMOTE DISP]	3. 25
Sheet sensor [SHEETsensor]	3. 26

Tool lifting speed setting [UP SPEED]	3. 27
Change-over of jog steps [JOG STEP]	3. 27
Dummy cut [DUMMY CUT]	3. 28
Mark detecting function [MARK DETECT]	3. 29
Sorting [SORTING]	3. 37
mm/inch [MM/INCH]	3. 40
Sheet setting [SHEET SET]	3. 41
Setup resetting [SETUP RESET]	3. 41

CHAPTER 4 IN CASE OF TROUBLE 4. 1

BEFORE TAKING A PHENOMENON AS A TROUBLE 4. 2

TROUBLE FOR WHICH ERROR MESSAGES ARE GIVEN ON THE LCD .. 4. 4

Displays under the remote mode	4. 6
--------------------------------------	------

APPENDIX..... A. 1

CUTTER BLADE A. 2

Replacing the cutter blade	A. 2
----------------------------------	------

Adjusting the cutter blade	A. 3
----------------------------------	------

SAMPLE OF OUTPUT A. 4

Dump list	A. 4
-----------------	------

List	A. 5
------------	------

SPECIFICATIONS OF THE MAIN UNIT A. 6

CHAPTER 1

SET-UP

This chapter provides basic knowledge such as configuration that you should have in prior to the use of the device as well as a method to assemble parts and that to connect cables.

CHECKING THE ACCESSORIES

The articles illustrated below are supplied with your device as accessories.

Check them up for correct quantities and appearance. If you should find any fault, please contact your distributor.

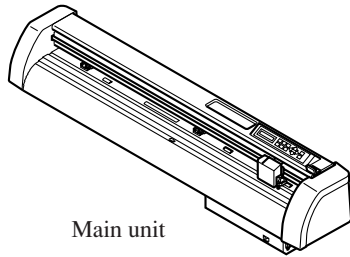

Main unit



Cutter holder



Water-ink ball-point pen

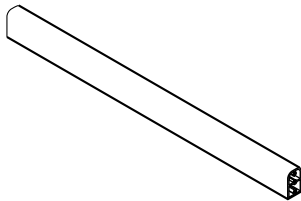

Stand stay
(CG-100EX/130EX)

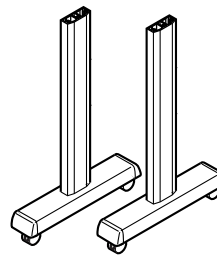

Stand
(CG-100EX/130EX)

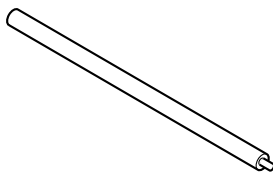

Roll bar assy.

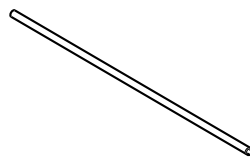

Turn-back lever
(CG-100EX/130EX)



Sheet set ring

Product name	Q'ty		Remarks
	CG-60EX	CG-100EX, 130EX	
Main unit	1	1	
Cutter holder	1 (E-1, E-2)	1 (E-1, E-2)	Provided with blade
Water-ink ball-point pen	1	1	Black
Stand stay		1	
Stand assy.		1	Right-hand type and left-hand type, one each
Roll bar assy.	2	4	
Turn-back lever		1	
Sheet set ring	2	4	
Roll hanger	2		Right-hand type and left-hand type, one each
Roll stay		4	Two of them are provided with a stopper.

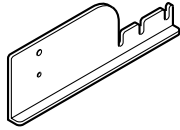

Roll hanger
(CG-60EX)

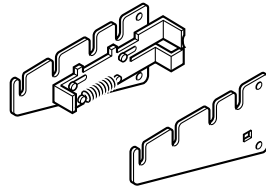

Roll stay
(CG-100EX/130EX)

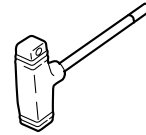

Hexagonal wrench key

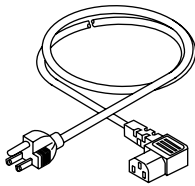

Power cable

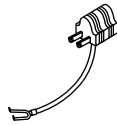

Grounding adapter



M8 Bolt
(CG-100EX/130EX)



Wing bolt
(CG-100EX/130EX)



Rubber cap
(CG-100EX/130EX)

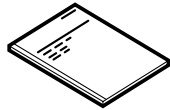

Operation Manual

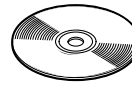

FineCut LE

Product name	Q'ty		Remarks
	CG-60EX	CG-100EX, 130EX	
Hexagonal wrench key	1	1	
Power cable	1	1	
Grounding adapter	1	1	
M8 bolt	2	4	CG-60EX: For mounting roll hangers CG-100EX, 130EX: For mounting stands and stay
Wing bolt		8	For mounting roll stays
Rubber cap		4	
Operation manual	1	1	
FineCut LE	1	1	

CONFIGURATION OF THE MAIN UNIT (CG-60EX)

Front of the main unit

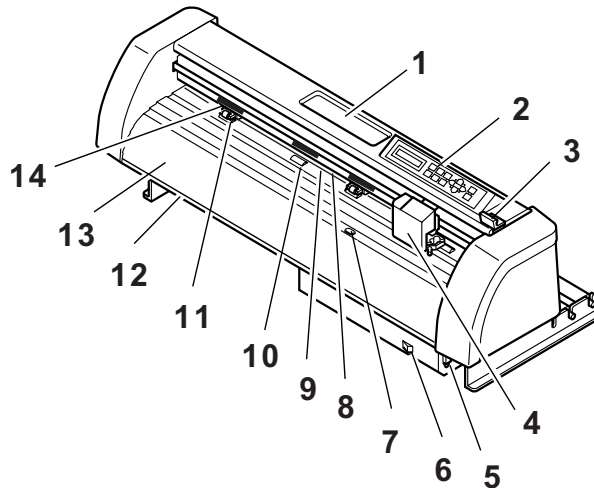

Rear of the main unit

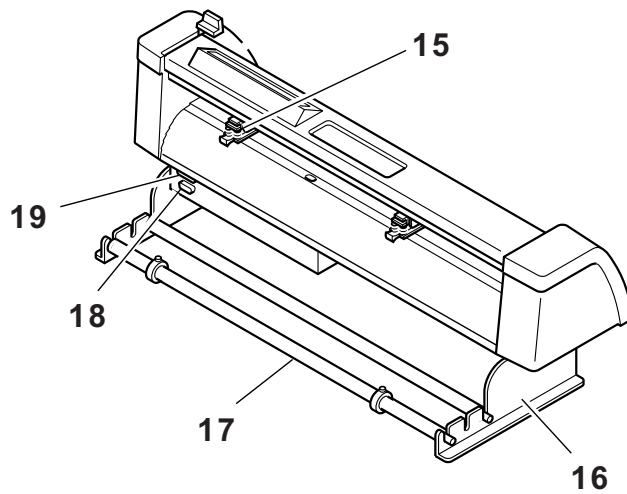

1) Tray

Small articles can be placed on it.

Note that the cutter has to be kept out of reach of children since it can be dangerous.

2) Operation panel

The device is operated and functions are set on the operation panel.

3) Sheet set lever

Tilting the lever away from you lowers the pinch rollers to retain the sheet of medium.

4) Carriage

The carriage travels from side to side while holding a tool. It is also used to raise/lower the tool.

5) AC inlet

The power cable is connected to the AC inlet.

6) Power switch

It turn on/off the power.

7) Sheet sensor

It detects the presence of the sheet and sheet length.

8) Pen line rubber

The device performs cutting or plotting on the pen line rubber.

9) Pen line sponge

The device performs pouncing on the pen line sponge.

10) Grid roller

The grid rollers operate in combination with the pinch rollers to feed out the sheet.

11) Pinch roller

The pinch rollers can be moved to the right or left to adapt to the size of sheet to be used.

The pinch rollers feed out the sheet while pressing it against the corresponding grid rollers.

12) Scale

The scale is used as a guide when loading a sheet of medium on the device. It is used in combination with the rear scale.

13) Platen

The sheet of medium moves along the platen.

14) “PINCH ROLLER SETTINGS” Mark

The marks indicate the locations at which the pinch rollers are set.

15) Clamp lever

This lever is used to adjust the force by which the clamp is held.

16) Roll hanger

Roll hangers support the roll bars.

17) Roll bar

A roll sheet is placed on the two roll bars.

18) RS-232C interface connector

The RS-232C compatible interface connector. It is connected to the RS-232C connector of the host computer via an interface cable.

19) 8 bit parallel interface connector

The Centronics compatible interface connector. It is connected to the printer connector of the host computer via an interface cable.

CONFIGURATION OF THE MAIN UNIT (CG-100EX/130EX)

Front of the main unit

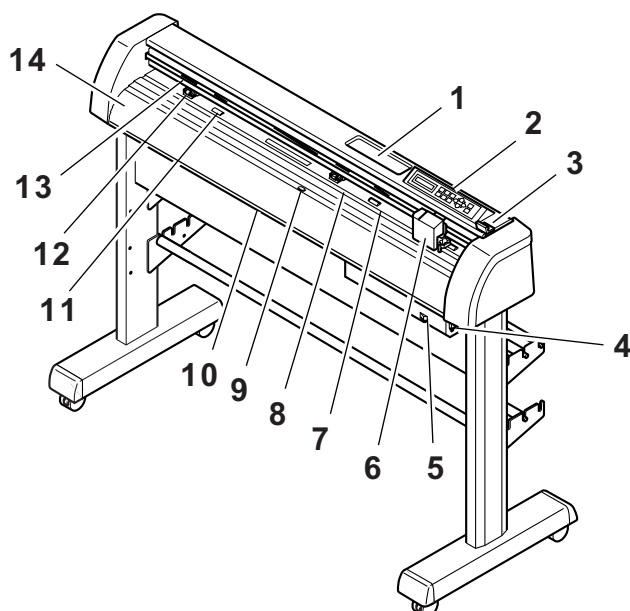

Rear of the main unit

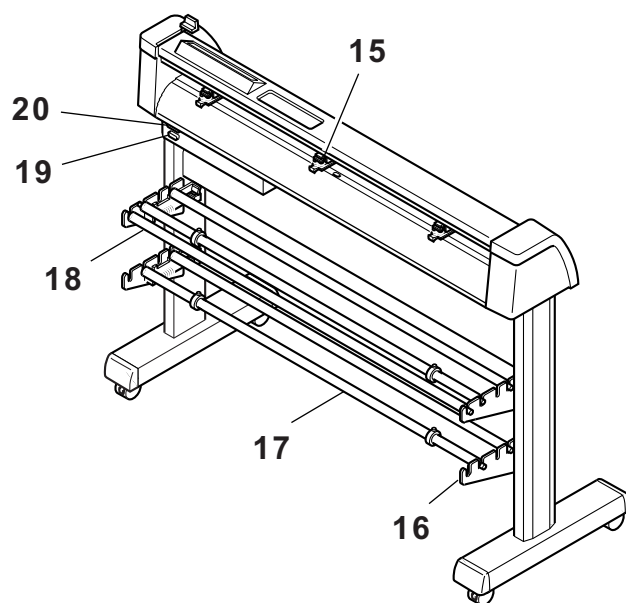

1) Tray

Small articles can be placed on it.

Note that the cutter has to be kept out of reach of children since it can be dangerous.

2) Operation panel

The device is operated and functions are set on the operation panel.

3) Sheet set lever

Tilting the lever away from you lowers the pinch rollers to retain the sheet of medium.

4) AC inlet

The power cable is connected to the AC inlet.

5) Power switch

It turn on/off the power.

6) Carriage

The carriage travels from side to side while holding a tool. It is also used to raise/lower the tool.

7) Pen line rubber

The device performs cutting or plotting on the pen line rubber.

8) Pen line sponge

The device performs pouncing on the pen line sponge.

9) Sheet sensor

It detects the presence of the sheet and sheet length.

10) Scale

The scale is used as a guide when loading a sheet of medium on the device. It is used in combination with the rear scale.

11) Grid roller

The grid rollers operate in combination with the pinch rollers to feed out the sheet.

12) Pinch roller

The pinch rollers can be moved to the right or left to adapt to the size of sheet to be used. The pinch rollers feed out the sheet while pressing it against the corresponding grid rollers.

13) “PINCH ROLLER SETTINGS” Mark

The marks indicate the locations at which the pinch rollers are set.

14) Platen

The sheet of medium moves along the platen.

15) Clamp lever

This lever is used to adjust the force by which the clamp is held.

16) Roll stay

Roll stays support the roll bars.

17) Roll bar

A roll sheet is placed on the two roll bars.

18) Turn-back lever

In the case where two rolls of sheet are loaded on the device, the turn-back lever works to prevent the lower roll sheet from coming in contact with the upper roll sheet.

19) RS-232C interface connector

The RS-232C compatible interface connector. It is connected to the RS-232C connector of the host computer via an interface cable.

20) 8 bit parallel interface connector

The Centronics compatible interface connector. It is connected to the printer connector of the host computer via an interface cable.

ATTACHING THE ROLL HANGERS (CG-60EX)

Mount the roll hangers following the procedures described below.

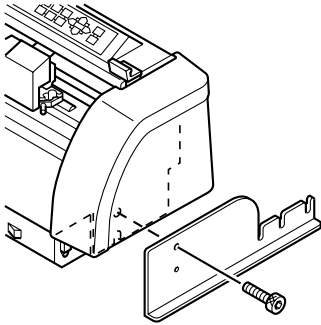

1) Fit the right-hand roll hanger to the main unit.

Align the projection of the roll hanger with the corresponding hole in the main unit.

Secure the roll hanger on the side plate with a hexagon head bolt using a hexagon wrench key supplied with the unit.

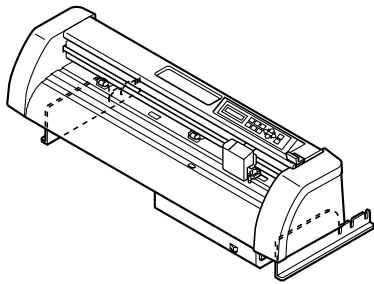

2) Mount the left-hand roll hanger following the same procedure as described above.

ASSEMBLING THE MAIN UNIT AND STANDS (CG-100EX, 130EX)

Attach the roll stays to the stands. The roll stay can be mounted to stand on the front or rear face of the main unit. Mount the roll stays to either stand according to your work.



* **The main unit is heavy in weight. Be sure to assemble the main unit and the stands with two or more persons to avoid danger.**

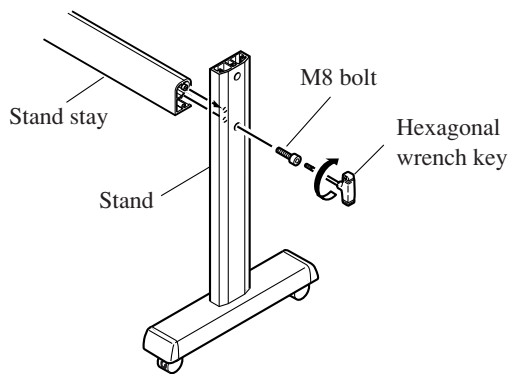

1) Attach the stand stay to the stand assembly.

Put the M8 bolt attached to the stay in the hole located inside the stand. Mount the stay to the stand with the M8 cap bolt using the hexagon wrench key supplied with the unit. The bolt has to be temporarily tightened.



* **Be sure to position the stay so that its rounded edge side faces upward.**

2) Lock the casters to secure the stands.

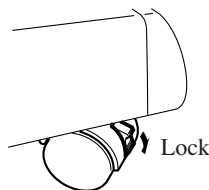

3) Aligning the slit on the side plate of the main unit with the pin of the stands, place the main unit on the stands.

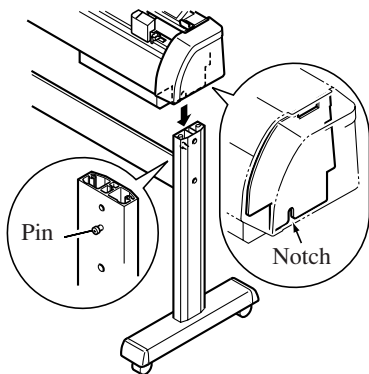

* **Do not hold the main unit by its both ends when putting the main unit on the stands to prevent hands from being caught between the main unit and the stands.**

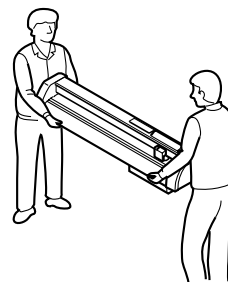

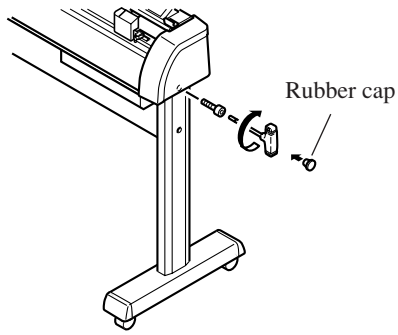

4) Fix the main unit on the stands.

Using the hexagon wrench key supplied with the unit, secure the main unit on the stands with two M8 cap bolts. After tightening the bolts, attach rubber caps onto them.

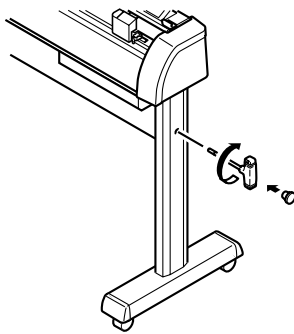

5) Securely tighten the bolts that are used to temporarily fix the stand stay onto the stands.

After tightening the bolts, attach rubber caps onto them.

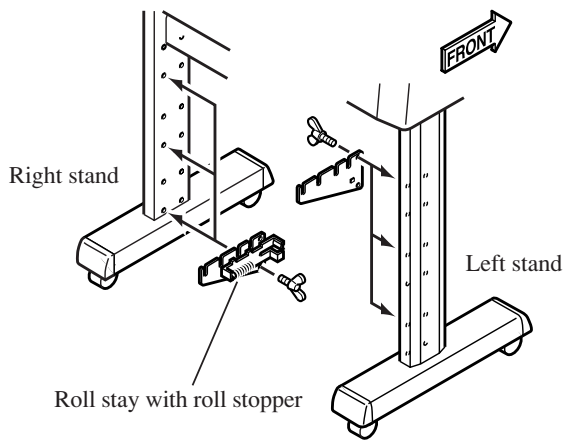

6) Attach the roll stays to the stands.

Attach the roll stays mounted with a roll stopper assembly to the right-hand side of the stand as observed from the front of the main unit.



- **Each roller stay can be mounted to one of three different locations. You can attach two roller stays respectively to the locations that facilitate your work.**

Attached the roll stays to the stands



Roll stays can be attached either (both) front or backside.
Three different heights are available.

1. When the roll stays are attached on the backside,

Attached the roll stopper with the set stopper on the right side.

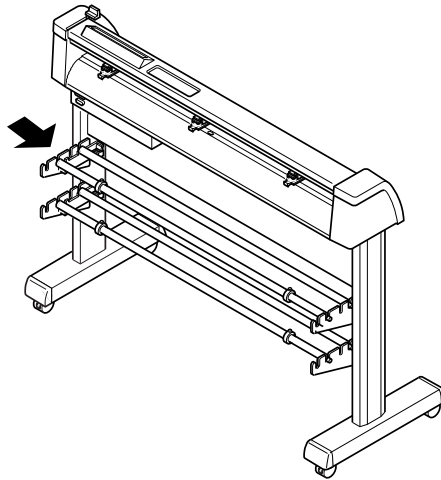

2. When the roll stays are attached on the front side,

Attached the roll stopper with the set stopper on the left side.

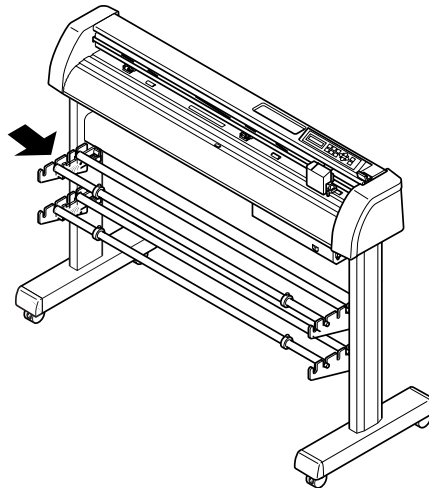

When optional roll shafts are purchased (OPT-C0149 for CG-100EX,OPT-C0150 for CG-130EX) , maximum 6 sets of roll shafts (total number of shafts in the front and backside) can be attached.

CONNECTING THE CABLES



- * When connecting the cables, turn off first the power to the device and that to the host computer which the power cable is to be connected.

■ Connecting the interface cables

The device comes with two different kinds of interfaces.

Select either one that matches the host computer.

- RS-232C compatible interface
- 8 bit parallel interface (Centronics compatible)

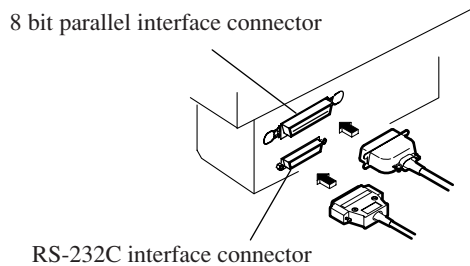

■ Connecting the power cables

After the completion of interface cable connection, connect the power cable.

Connect the power cable to the receptacle of the following power specification.

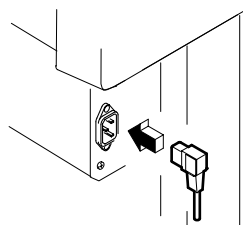

- Voltage AC220/240V $\pm 10\%$
- Frequency 50/60Hz $\pm 1\%$
- Capacity: 100W or more (equivalent to 2 A)

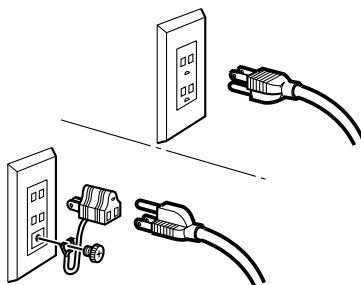

- If you use 2P receptacle, connect a grounding adapter supplied with the unit to the power cable plug. Ground the green wire (ground wire) of the adapter.

If the ground wire cannot be grounded, consult your nearest electrical service shop.

CHAPTER 2

BASIC OPERATIONS AND SETUPS

This chapter describes a series of operations to be carried out from the loading of tools and sheets to the actual cutting (plotting) and related operation setups along the basic operation flow.

OPERATION PANEL

Configuration of the operation panel is as shown below.

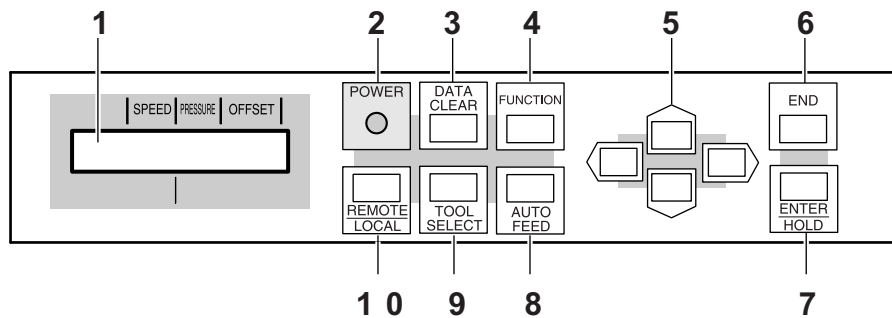

1) Display panel

The display panel indicates tool conditions such as speed, pressure and offset, tool coordinates, functions and error messages.

2) POWER lamp

It lights up when the power to the device is turned on.

3)  Data clear key

This key is used to clear the data received.

4)  Function key

This key is used to specify the function.

5)  Jog key

These arrow keys are used to shift the carriage or sheet in the corresponding direction or change settings.

6)  End key

It is used to cancel the value is last previously input.

7)  Enter/hold key

This key is used to enter the last previous input value for a setup item.

8)  Auto feed key (Refer to P. 3. 10)

This key is used to execute the sheet feeding.

9)  Tool select key





This key is used to select a tool and establish tool conditions.

10)  Remote/Local key

It is used to change over the operation mode between the REMOTE mode and LOCAL mode. If this key is pressed while the device is in operation, the device will be brought to a halt. To restart the device, repress the key.

Jog keys

The arrow keys are used as described in the table below.

	Before the detection of a sheet	After the detection of a sheet	When selecting a function	When inputting a choice selected among several alternatives
	Detects the sheet width and the top end of the sheet. (In the case where a roll sheet is loaded onto the rear of the device)	Shifts and carriage to the left.		
	Detects the width and length of the sheet. (In the case where a cut sheet is loaded onto the rear of the device)	Shifts the carriage to the right.		
	Detects the sheet width and the top end of the sheet. (In the case where a roll sheet is loaded onto the front of the device)	Shifts the sheet away from you.	Restores the last previous function.	Selects the last previous value.
	Detects the width and length of the sheet. (In the case where a cut sheet is loaded onto the front of the device)	Moves the sheet toward you.	Moves to the next function.	Select the next function.

BASIC OPERATION OF THE KEYS

Basic operation of the keys mounted on the operation panel is described below.

■ Changing the operation mode

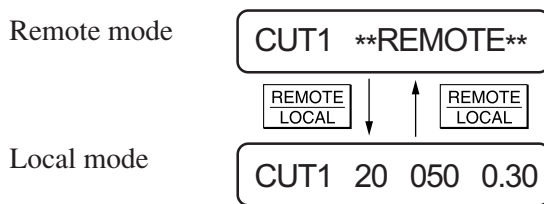

Refer to page 2.9 for the explanation of operation modes.

Press the  key to change over the operation mode between the remote mode and local mode.



■ Selecting the function menu

Press the  key under the local mode to select the function menu.

Function menu will be displayed every time the  key or  or  key is pressed.

Pressing the  key will execute the menu displayed.

Refer to Chapter 3 for the types of function menus.

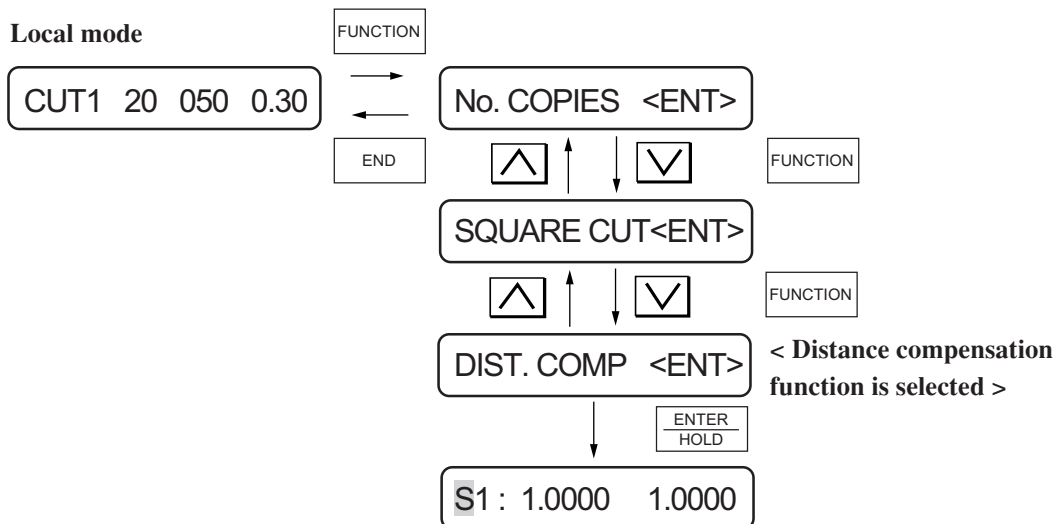

■ Selecting the setup item from the function menu

Select [SET UP] from the function menu following the above-stated procedure.

Press the **FUNCTION** key or **▲** or **▼** key to call the setup items.

Pressing the **ENTER HOLD** key will select the setup item currently displayed.

Refer to Chapter 3 for the types of setup items.

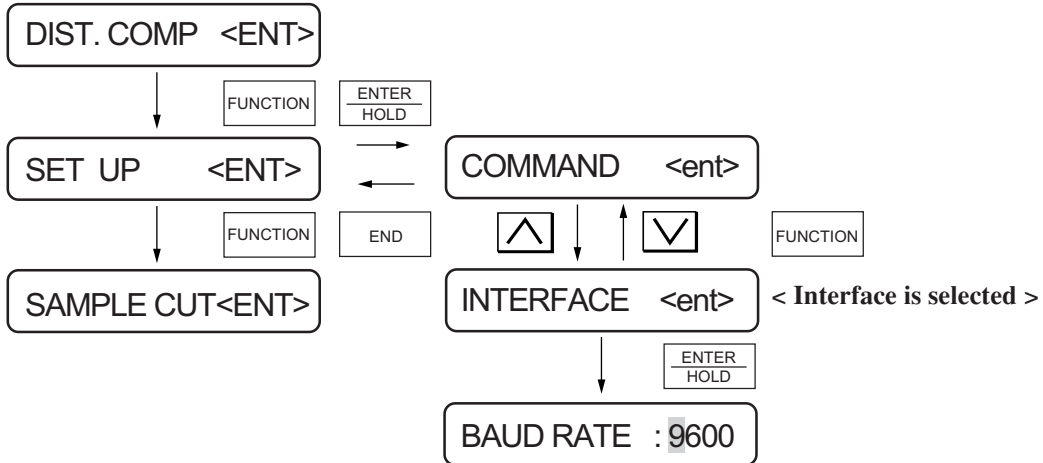

■ Inputting and entering a setting

Input a setting by pressing the **▲** or **▼** key and enter the setting by pressing the **ENTER HOLD** key.

For example, when you want to input cutting conditions, press the **TOOL SELECT** key to call the tool of which cutting conditions are to be established and press the **ENTER HOLD** key to select it.

The cursor blinks at settings of “SPEED.” Input a desired setting using the **▲** or **▼** key. Press the **ENTER HOLD** key to enter the value. Then, the cursor will move to the next item. Input settings for “PRESSURE” and “OFFSET” following the same procedure as in the case of “SPEED.” Then, press the **ENTER HOLD** key to enter the setting.

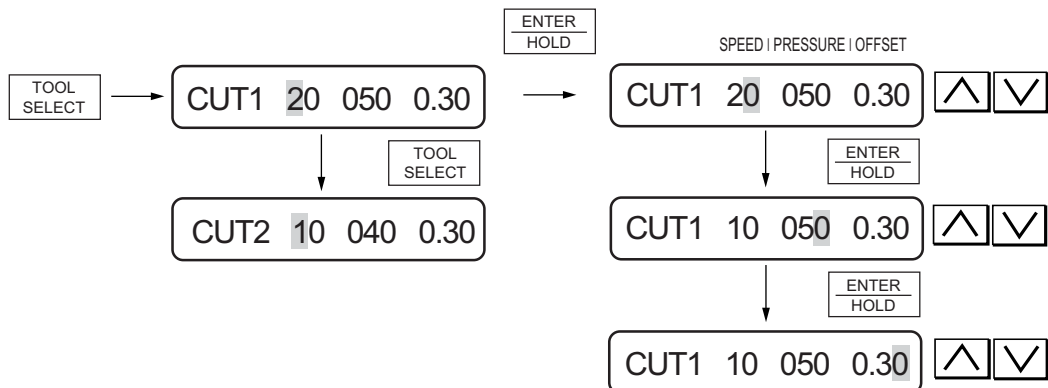

■ Input numeric values for the number of copies, etc.

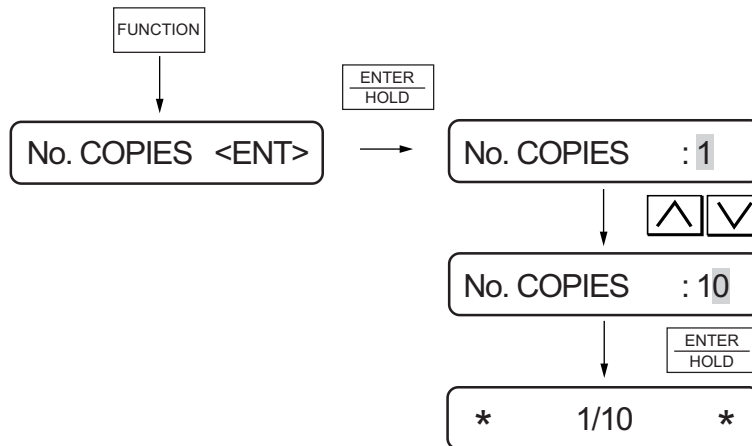

■ Enter “valid” or “invalid” of the setting.

Every press on ▲ or ▼ key will alternately display “ON” or “OFF.”

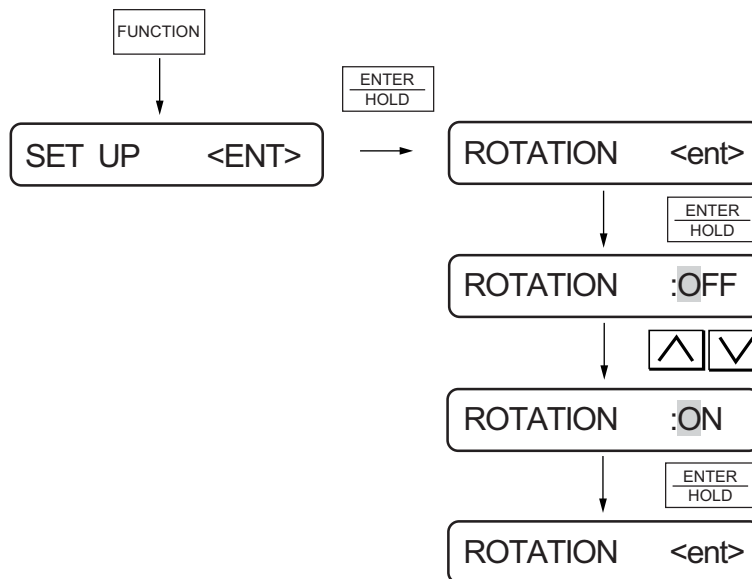

BASIC PROCEDURE FOR OPERATING THE DEVICE

After the completion of assembly of the main unit and connection of the cables, operate the device referring to the below-stated flow.

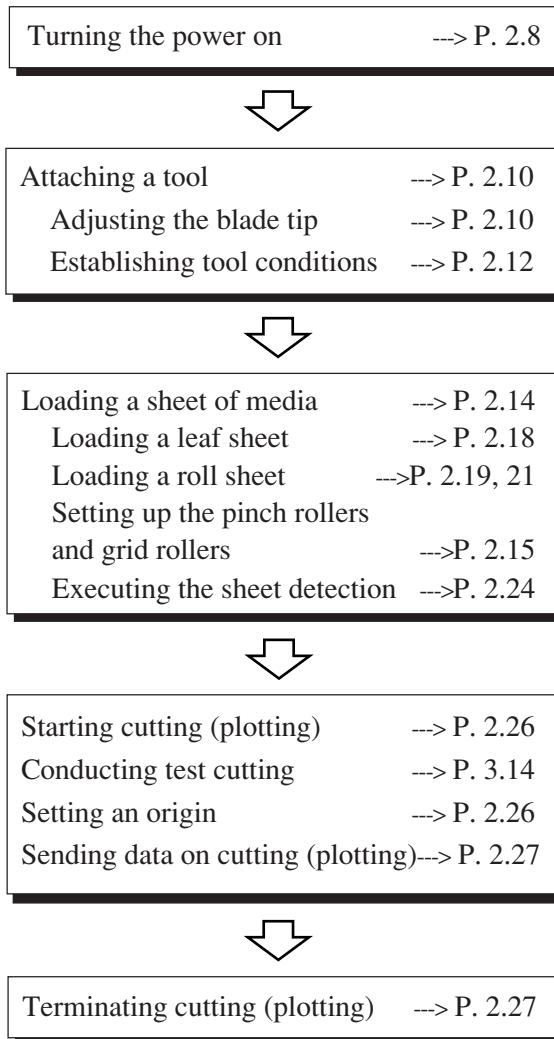

TURNING THE POWER ON



- * Be sure to check to ascertain that the pinch rollers have been raised before turning the power on.
- * Turn on the power switch of the device after turning on the power to the host computer. If the aforementioned order is not correctly followed, the device can malfunction.

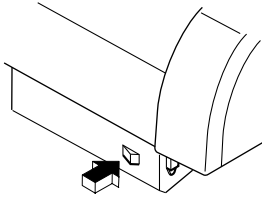

- 1) Press the “|” side of the power switch.



- When the device is turned on, the device will enter operation modes in the predetermined order. Refer to page 2.4 for the operation modes.

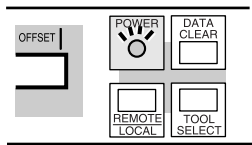

- 2) The **POWER** indicator lamp lights up in green.

The sheet suction fan rotates.

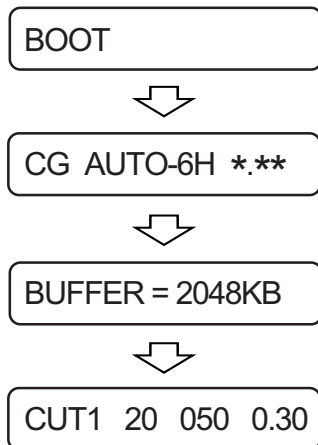

- 3) Check the receiving buffer.

Then, the tool conditions for the currently selected tool appears on the LCD.

Operation modes

The device operates under three different operation modes as shown below.

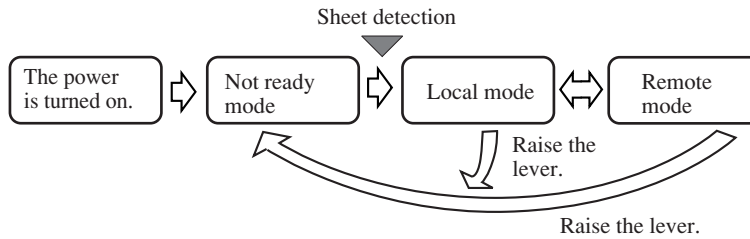

■ Not-ready mode

When the power is turned on, the device enters the not-ready mode and stays there until a sheet of media is detected. The keys other than the

REMOTE
LOCAL

 and

AUTO
FEED

 keys are effective. The function to enable operations of the jog keys or plotter is not effective. (Such as in the case of executing test cutting or sample cutting)

If you executed any of the aforementioned disabled function, the following message will appear on the LCD.

ERR30 OPERATION

■ Local mode

The device enters the local mode after the sheet detection.

Normally, tool conditions appear on the display panel. Under the local mode, all keys are effective to enable setups.

The device is able to receive data sent from the host computer, however, it will not perform cutting (plotting).

Example of display

CUT1 20 040 0.30

■ Remote mode

The device performs cutting (plotting) under this mode.

The

REMOTE
LOCAL

 key and

ENTER
HOLD

 keys are effective.

If you press the

REMOTE
LOCAL

 key during cutting (plotting), the device will be put on hold. Another press on the same key will allow the device to resume cutting (plotting).

If you press the

ENTER
HOLD

 key while the device is put on hold, the hold function that corrects the sheet that has slipped out of position (see page 3-11).

Example of display

CUT1 **REMOTE**

ATTACHING A TOOL

The below-stated tools can be used with the device.

Cutter, pen (water-ink ball-point pen) supplied with the unit, and pouncing tool (optional)

To use the cutter, adjust the blade tip of the cutter in prior to attaching it.



- Refer to the appendix for how to replace the cutter blade and how to adjust the blade tip of a cutter that is not supplied with the unit.

Adjusting the blade tip of the cutter

Adjust the protruding amount of the cutter blade to the type of cutter and sheet of media to be used.

When you have adjusted the cutter blade, conduct test cutting to check the cutter for sharpness.

For the cutter supplied with unit, the protruding amount of the blade can be adjusted with the cutter mounted in the pen carriage.

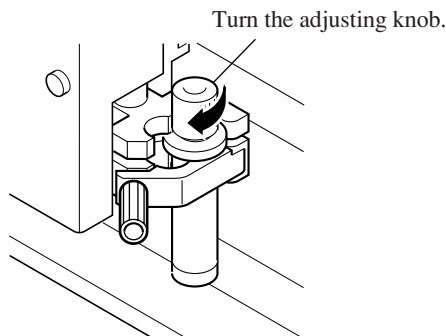

■ Protruding amount of the cutter blade

$$\text{Protruding amount of the cutter blade} = \frac{(\text{Film thickness} + \text{Base paper thickness})}{2}$$

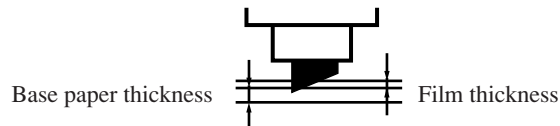

- * Take care not to protrude the blade too much. If the cutter is used with its blade excessively protruded, the cutter can cut out the base paper to damage the main unit.

Attaching a tool

Attach a tool to the tool holder of the carriage.

The tool can be loaded this side or far side of the tool holder. Determine the mounting location according to your work.

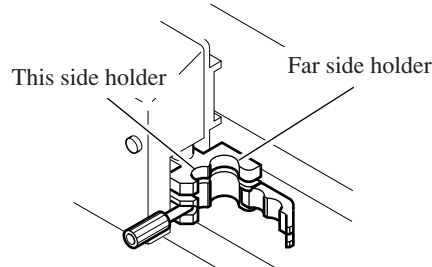

Far side holder	Pen-plotting or cutting of PVC sheet on the pen line rubber is enabled.
This side holder	Pouncing or half-cut cutting on the pen line sponge is enabled.



- * Two tools cannot be loaded in the tool holder at a time.
- * If the device performs cutting on this side sponge, an adequate pressure will not be applied to the sheet of media, adversely affecting the cutting result.
- * The device is not able to perform pouncing on the far side rubber.

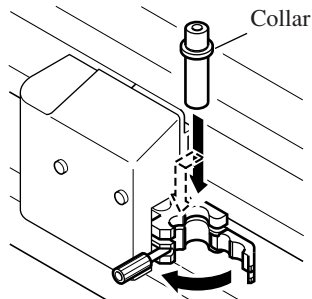

1) Put a tool in the tool holder.

Fitting the collar of the tool in the slit on the tool holder, put the tool in the holder.

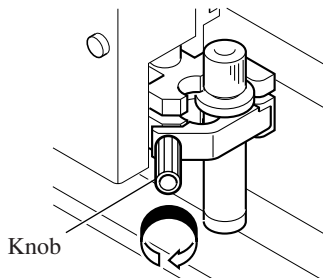

2) Turn the knob of the tool holder clockwise until the tool is secured.





- * Be sure to securely fix the tool. If not, accurate and high-quality cutting (plotting) results will not be obtained.

TOOL CONDITIONS SETTING

Three different tool conditions are to be set such as cutting conditions, plotting conditions and pouncing conditions.

Specify “SPEED,” “PRESSURE” and “OFFSET” settings that suit the tool to be used.

To set tool conditions, press the  key under the local mode, select tool condition with  key and input settings.

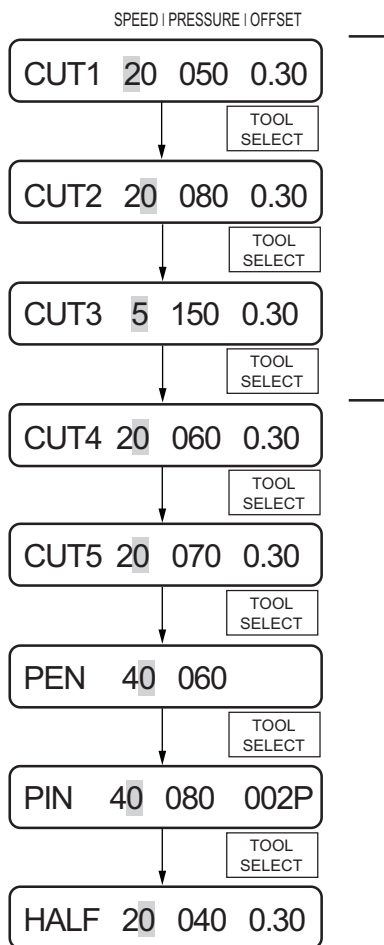

■ Cutting conditions

Enter tool conditions for the operation using a cutter. Three kinds of cutting conditions (CUT1, CUT2 and CUT3) can be entered at a time. This means these conditions can be entered separately according to the cutter to be used. Once cutting conditions are specified, the cutter will perform a dummy cutting (to adjust the blade direction) (see page 3.30).

■ Plotting conditions

Enter conditions for the operation using a pen.

■ Pouncing conditions

Enter conditions for the operation using the pouncing function (see page 3.24).

OFFSET condition indicates the interval between pins (P).

■ Cutting conditions (HALF CUT conditions)

In the case where the HALF cutting (broken line cutting) is set to the ON state, enter the HALF cutting conditions (see page 3.11). Once the HALF cutting conditions are specified, the cutter will perform a dummy cutting (to adjust the blade direction) (see page 3.28).

- **SPEED :** Cutting (plotting) speed.
- **PRESSURE :** Pressure with which the tool hold the sheet of media.
- **OFFSET :** The amount of the cutter blade tip from the holder.
 If the offset amount is increased, square-shaped characters will be cut/plotted.
 If it is decreased, round-edged characters will be finished.
 Change the offset value depending of the sheet thickness or the type of blade.
 For the cutter supplied with the unit, set the offset to 0.30 mm.

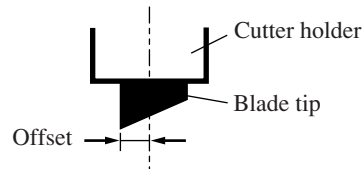

■ Setting value

Tool conditions	SPEED	PRESSURE	OFFSET
Half cut conditions	1 to 10 cm/s (1 cm/s step) 15, 20, 25, 30, 35, 40, 50, 60, 70, 80 cm/s	10 to 20 g (2 g step) 20 to 100 g (5 g step) 100 to 300 g (10 g step)	0.00 to 2.50 mm (0.05 mm step)
Plotting conditions	1 to 10 cm/s (1 cm/s step) 15, 20, 25, 30, 35, 40, 50, 60, 70, 80 cm/s	10 to 20 g (2 g step) 20 to 100 g (5 g step) 100 to 300 g (10 g step)	
Pouncing conditions	1 to 10 cm/s (1 cm/s step) 15, 20, 25, 30, 35, 40, 50, 60, 70, 80 cm/s	10 to 20 g (2 g step) 20 to 100 g (5 g step) 100 to 300 g (10 g step)	1 to 100 mm



* **In the case where the pressure is smaller than 20 g, set the speed using a 10 cm/sec as a guide. If the speed is higher than the appropriate value, the tool can rise to produce blurred characters or a portion that remains uncut.**



- **Reference values of conditions for plotting**
Before actually cutting a sheet of media, conduct test plotting to check the quality of finished characters and marks.

Type of pen	SPEED	PRESSURE
Water-ink ball-point pen (0.3 mm)	40 cm/s	60 g
Oil-based ink ball-point pen	40 cm/s	150 g

LOADING A SHEET OF MEDIA

Either a cut sheet or a roll sheet can be loaded on the device.

The pinch rollers and grid rollers hold the sheet in position.

Specify the location of the pinch rollers to match the sheet to be used.

The table given below shows the width of sheet that can be loaded on the device and the maximum cutting area of the device.

Model name	Sheet width	
	mm	inch
CG-60EX	110 to 624	24
CG-100EX	110 to 711	24
	755 to 912	30
	871 to 1028	36, 42
CG-130EX	110 to 711	24
	755 to 1070	30, 36, 42
	1167 to 1324	48, 50, 52



- After loading a sheet of media on the device, execute the sheet detection (see page 2.24).

In the case where a long sheet of media is used, only the sheet width can be detected (see page 2.25).

Maximum cutting area

The maximum cutting area (the area in which cutting (plotting) is enabled) varies depending on the location of pinch rollers and that of the origin. The white portion of the illustration shown below represents the maximum cutting area.

Model name	Cutting area	
	The origin is set at the lower right corner of the area.	The origin is set at the center of the area.
CG-60EX	600 mm x 51 m	600 mm x 3 m
CG-100EX	1005 mm x 51 m	1005 mm x 51 m
CG-130EX	1300 mm x 51 m	1300 mm x 51 m

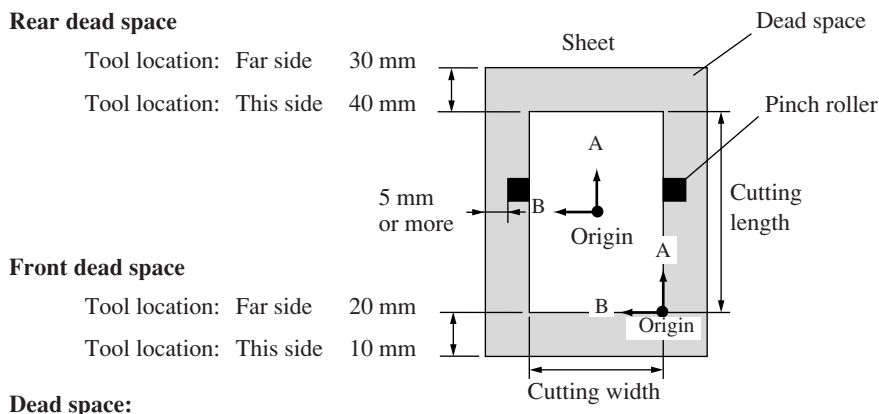

Pinch rollers and grid rollers

The portion located between the pinch rollers 1 and 2 is the travel range of the carriage. Move the pinch rollers to appropriate grid rollers in accordance with the width of sheet to be loaded on the device. The areas within which the pinch rollers may be shifted are described below. Change the location of the pinch rollers using the “PINCH ROLLERS SETTINGS” marks as a guide.

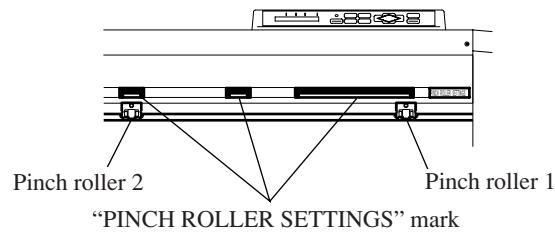

- * Be sure to raise the pinch rollers whenever the machine is not in operation.
- * Keep away from the rotating grid rollers. Injury could result if the rotating grid rollers are contacted since the rotating grid rollers can shave the skin or the rotating grid rollers and platen can catch fingers between them.
- * Never set the pinch rollers with deviated or separated from the grid rollers. If the pinch rollers are not properly placed, they may fail to retain the sheet during cutting (plotting).

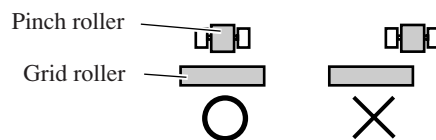

Travel range of pinch rollers 1 and 2

■ CG-60EX

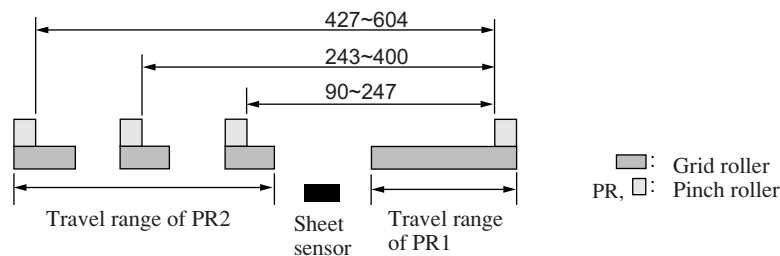



* For CG-100EX and -130EX, move the pinch roller 3 to the retracted point located at the leftmost end of its travel range in the case where the pinch roller 3 is not used for operation. If the pinch roller 3 is located at any position other the retracted point, the device will not be able to perform the sheet detection.

■ CG-100EX

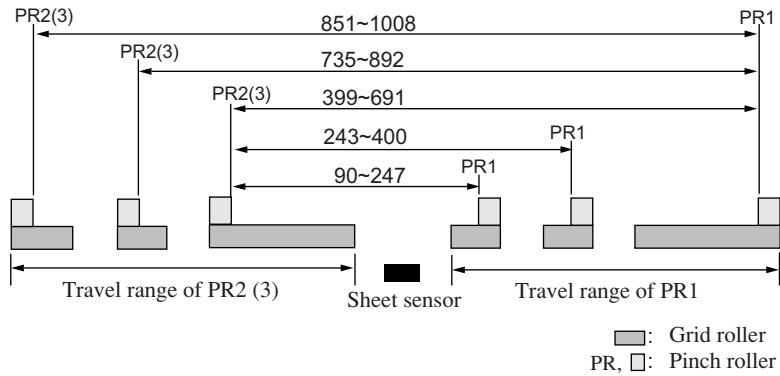

■ CG-130EX

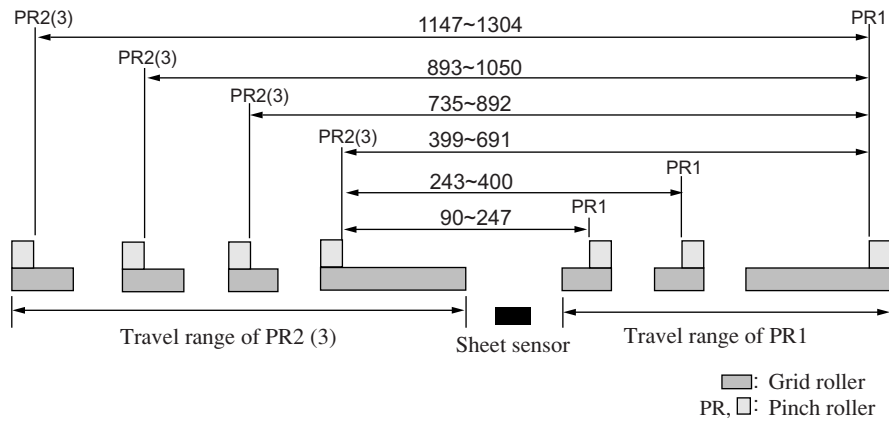

Selecting the clamp force

The clamp force of the sheet clamp can be changed in two levels using the clamp lever. Select higher or lower level of the clamp force that matches the sheet to be used.



* Set the clamp force of the left and right sheet clamps equally. If the clamp pressure is not set to an equal level, the sheet could deviate from the correct position. To cut a long media, set the clamp force to the higher level.

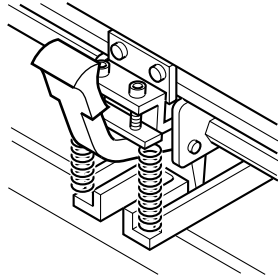

High mode:
Raise the clamp force up/down lever.

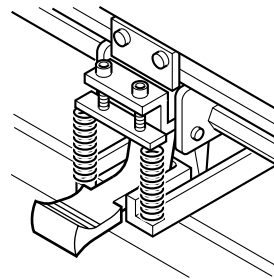

Low mode:
Lower the clamp force up/down lever.

Clamp force up/down lever	Application
High mode	For cutting the sheet. In the case where heavy-weight paper (70 kg or more) is used.
Low mode	In the case where light-weight paper (less than 70 kg) is used. In the case where impressions of the pinch rollers should not be left on the sheet of media.

Loading a leaf sheet

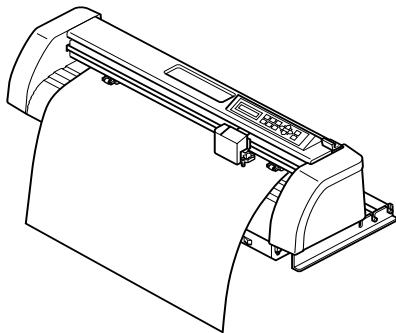
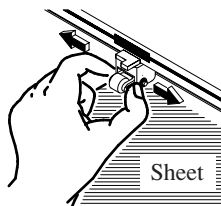
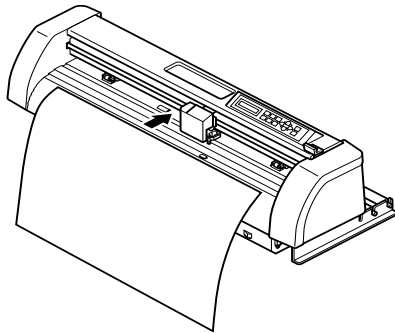

Displays the detected size of the leaf sheet.

A=654 B=459

Unit: mm

CUT1 20 050 0.30

Displays the currently specified tool conditions.

1) Pass a leaf sheet under the platen.

Tilt the set lever toward you, raise the pinch rollers and adjust the rightmost end of the leaf of sheet to the scales mounted on the front and rear of the device.

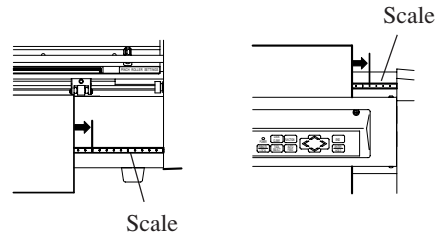

2) Move the pinch rollers according to the sheet width.

Refer to page 2.15 for the pinch rollers.

3) Tilt the sheet set lever away from you and lower the pinch rollers.

The display shown on the display panel will change as illustrated below.

ROLL <R> LEAF

ROLL ^Fv LEAF

4) Press the or key to select "LEAF."

In the case where the media is loaded from the rear: 

In the case where the media is loaded from the front: 

The device performs the sheet detection (see page 2.25), then performs a dummy cutting (see page 3.28).



* The device is not able to detect a leaf sheet of which length is 3 m or more.

Loading a roll sheet (CG-60EX)

In the case where a roll sheet is used, roll hanger to be mounted on the device.
Refer to page 1.18 for how to mount the roll hanger.

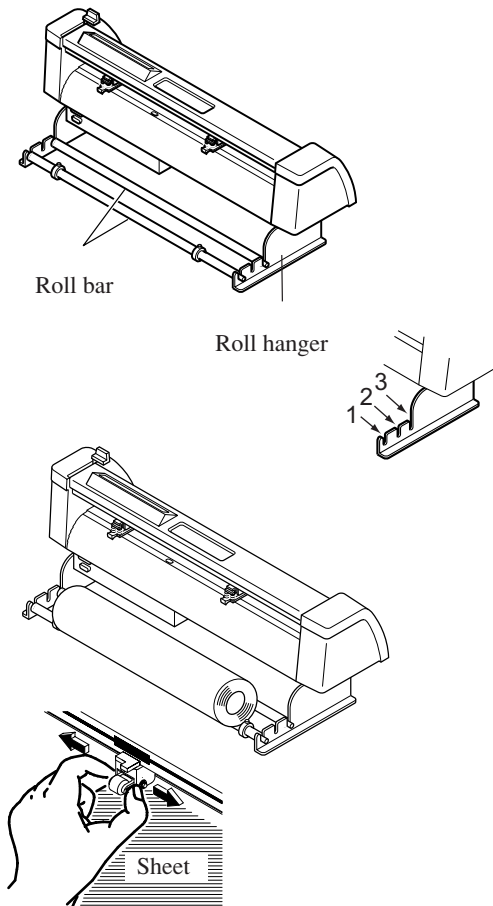

1) Attach the roll bar assembly to the roll hangers.

Place the roll bar assy. in the slit 1 or 2 according to the outside diameter of the roll sheet to be used.



- If the outside diameter of the roll sheet is 3 inches or more, put the roll bar assy. in the slit 1 or 2.
- If the outside diameter of the roll sheet is 3 inches or less, put the roll bar assy. in the slit 2 or 3.

2) Load a roll sheet.

Place a roll sheet on the roll bar, pass the top end of the sheet through the platen and change the location of the pinch rollers according to the sheet width.



- * Change the location of the pinch rollers so that each one is placed 5 mm or more inside the sheet width. If not, the sheet can slip off the pinch rollers while it is being fed.

3) Hold a sheet

Tilt the sheet set lever away from you and lower the pinch rollers.

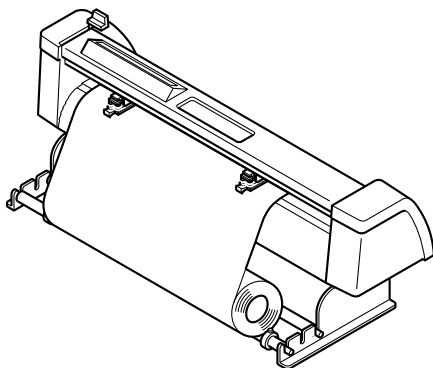

ROLL <R> LEAF

ROLL ^FV LEAF

Displays the detected size of the leaf sheet.

A = **** B = 559

Unit: mm

CUT1 20 050 0.30

Displays the currently specified tool conditions.

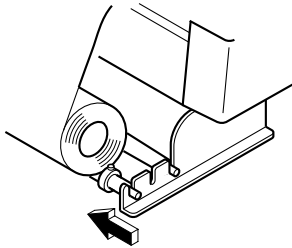

4) The display shown on the LCD changes.

Press the  key to select “ROLL.”

The device performs the sheet detection (see page 2.24), then performs a dummy cut (see page 3.28).

The display panel gives the indication as shown on the left.

5) Secure the roll sheet with the sheet set rings.

Move the respective sheet set rings to the rightmost and leftmost ends of the roll sheet and fix them by tightening screws to secure the roll.

6) Press the  key to draw out the sheet by the length to be used.



* In the case where a roll sheet is used, draw out the sheet wound to slacken it.

Loading a roll sheet (CG-100EX, 130EX)

In the case where a roll of sheet is used, roll stays are required to be mounted on the device.
Refer to page 1.10 for how to mount the roll stays.

1) Attach the roll bar assembly to the roll stays.

Place the roll bar assy. in the slit 1 or 2 according to the outside diameter of the roll sheet to be used. Fit the turn-back lever

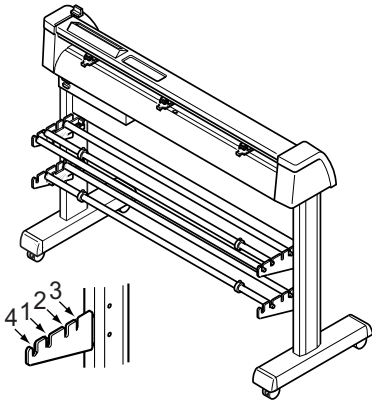

- If the outside diameter of the roll sheet is 3 inches or more, put the roll bar assy. in the slit 1 or 2.
- If the outside diameter of the roll sheet is 3 inches or less, put the roll bar assy. in the slit 2 or 3.
- In the case where two rolls sheet are loaded on the device, the turn-back lever works to prevent the lower roll sheet from coming in contact with the upper one.

2) Load a roll sheet.

Place a roll sheet on the roll bar, pass the top end of the sheet through the platen and change the location of the pinch rollers according to the sheet width.

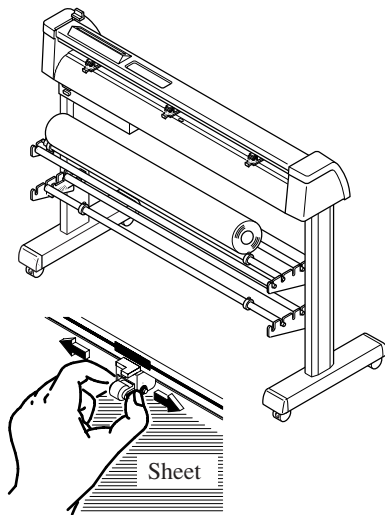

- * Change the location of the pinch rollers so that each one is placed 5 mm or more inside the sheet width. If not, the sheet can slip off the pinch rollers while it is being fed.

3) Lock the roller stoppers.

Press the lock lever toward the rear from the front of the main unit to lock them.

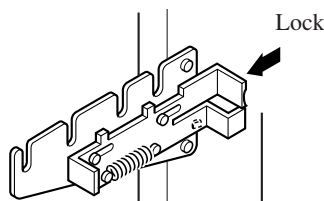

- The roll stoppers work to prevent the roll sheet from turning when you draw out the rolled sheet.

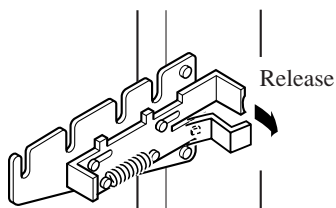
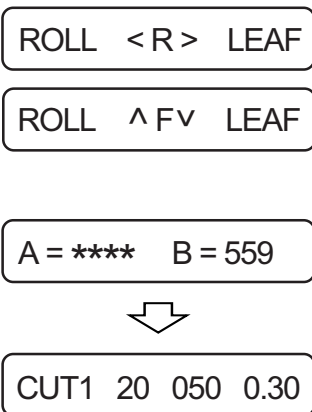
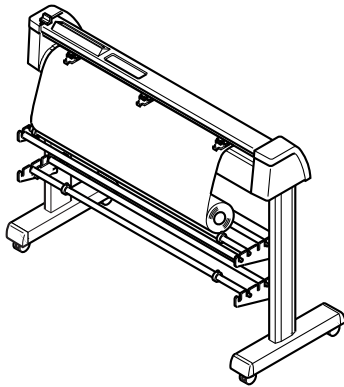

4) Hold a sheet.

Draw the sheet to tense it.

Tilt the sheet set lever away from you.

- **In the case where the power to the device has been turned on:**
The suction fan will rotate to adhere the rolled sheet by suction.
- **In the case where the power to the device has been turned off:**

The suction fan will not rotate.

It is, therefore, necessary to tilt the sheet set lever away from you while retaining the sheet with your left hand to prevent the sheet from warping.

5) The display shown on the LCD changes.

Press the  or  key to select "ROLL."

: In the case where the roll sheet is loaded this side

: In the case where the roll sheet is loaded far side

The device detects the width and front end of the rolled sheet.

After giving the width of sheet on the LCD, the sheet will conduct a dummy cut (see page 3.29) and displays the currently specified tool conditions.

6) Release the roll stopper.

Draw the roll stopper toward you from the front side of the main unit.

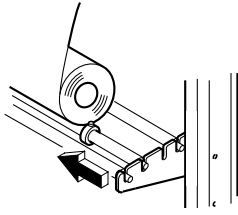

7) Secure the roll sheet with the sheet set rings.

Move the respective sheet set rings to the rightmost and leftmost ends of the roll sheet and fix them by tightening screws to secure the roll.

8) Draw out the rolled sheet by the length to be used.

Press the

AUTO FEED

 key to draw out the rolled sheet.

Sheet detection

The width and length of the sheet is detected by pressing the arrow keys or END key in accordance with the sheet loaded.



- * Once the length of a sheet of media has been detected, if the received data is larger than the sheet, only the portion of data that exceeds the sheet will not be cut.

If the length of a sheet of media is not detected, the device will terminate cutting operation at the time when data goes beyond the sheet.

- * If the sheet sensor feature is set to the [OFF], a press on ^ , v , < or > key will cause the device to perform the same sheet detection as with the case where the END key is pressed.

The setting direction of the media is rendered effective.

- * The maximum length that can be detected at the front and rear ends of the sheet of media is 3 m.

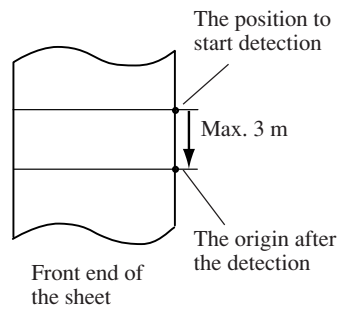

When detecting the front end of the sheet

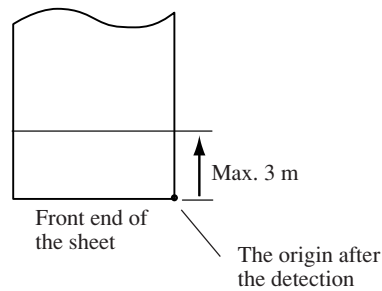

When detecting the rear end of the sheet







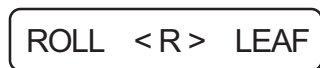

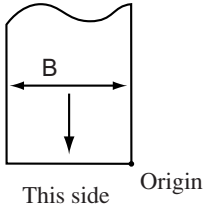
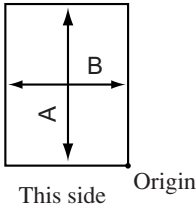
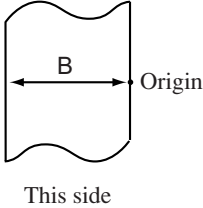

■ Method to detect a sheet

When a sheet of media is retained with the pinch rollers, the following two displays will appear alternately on the LCD panel.

Select the key in accordance with the direction of the sheet loaded on the device.

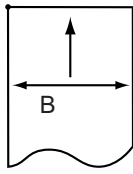
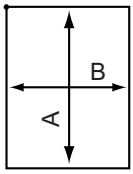

The device detects a sheet of media in the five different methods as shown below.

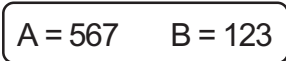
Key	 A roll sheet is loaded to the rear face of the device.	 A leaf sheet is loaded to the rear face of the device.	 Only the sheet width is detected.
Detecting method	The sheet width is detected first, then front end of the sheet is detected. 	The sheet width is detected first, then the sheet length is detected by feeding the sheet forward and backward. 	Only the sheet width is detected. 
Example of display after the sheet detection			
Key	 A roll sheet is loaded to the front face of the device.	 A leaf sheet is loaded to the front face of the device.	
Detecting method	The sheet width is detected first, then rear end of the sheet is detected. 	The sheet width is detected first, then the sheet length is detected by feeding the sheet forward and backward. 	
Example of display after the sheet detection			



- * In the case where the detected dimension is 3 m or more, the display “****” will appear on the LCD.



- In the case where a long sheet of media is used or a drawn-out sheet is used from its middle area, the sheet detection will require an extended period of time. In such a case, the detection time can be reduced by detecting only the sheet width.

STARTING CUTTING (PLOTTING)

After the completion of loading of a tool and sheet and establishment of tool conditions, you can start cutting (plotting).



- **Check up the following settings before executing cutting (plotting).**

Setting of the origin (see page 2.26)

Priority of commands (see page 3.24)

Setting of communication conditions (see page 3.18)

Setting an origin

The origin is a reference point of data to be cut (plotted).

To start cutting (plotting), be sure to specify an origin in prior.

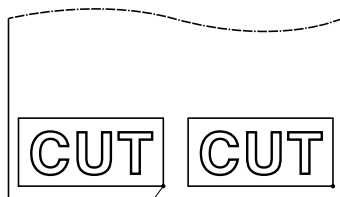

New origin

- 1) **Move the head to a point that is specified as an origin.**



: Moves the head to the right.



: Moves the head to the left.



: Moves the sheet away from you.



: Moves the sheet toward you.



- **Every time you press the  key, the tool will go up and come down alternately. This helps you to set an origin at a correct position with accuracy.**

** ORIGIN **



A = **** B = ****



CUT1 20 050 0.30

- 2) **Press the  key to enter the origin.**

After the effective cutting area appears on the LCD, tool conditions will appear there.

Starting cutting (plotting)

CUT1 **REMOTE**

CUT1 * 1356KB *



■ When selecting the cutter

CUT1 **REMOTE**

■ When selecting the pen

PEN **REMOTE**

- 3) After the set of the origin, press the  key.

The display on the LCD will change over to the remote mode.

- 4) Send data from the host computer to the device.

Once the device receives data, the device will give the remaining amount of data while performing cutting (plotting).

When the device completes cutting (plotting), the display shown on the left will appear on the LCD.

Putting the cutting (plotting) on hold

To temporarily stop the device during cutting (plotting), press the  key once. Another press on the same key will allow the device to resume cutting (plotting).



- If any function that initiates some action or any operation that can affect the command coordinate system is executed during a pause period, the error message shown below will appear on the LCD.

ERR34 DAT REMAIN

In the event that the error message appears on the LCD, press the  key to cut the remaining portion of data or execute data clearing (see page 3-10).

CHAPTER 3

EXPLANATION OF FUNCTIONS

This chapter explains types and settings of functions provided by the device.

LISTING OF FUNCTIONS

The device is provided with the following functions.

Refer to chapter 3 for how to select and enter the functions.

Functions invoked with the jog keys (arrow keys)

The jog function is used to move the top end of a tool to a given location to set coordinates of the plotter.

Item	Description of function
Origin select	Specifies an origin for cutting (plotting).
Cutting area setting	Specifies an area, in accordance with the sheet to be used, within which cutting (plotting) is performed.
Axis alignment	Aligns the axis of the sheet to be used with that of the device.
Paper cut	Cuts off the sheet of media.
Digitize	Sends a given coordinate to the host computer.

Functions invoked with specific keys

Item	Description of function
Tool select	Sets a tool to be used to a cutter or pen.
Data clear	Clears data being cut (plotted).
Auto feed	Feeds the sheet of medium by the amount to be used.
Hold	Corrects displacement of the sheet being used for cutting (plotting).

Functions

Item	Description of function
No. copies	Performs cutting according to the received data on two or more sheets of medium.
Square cut	Performs cutting of a square to verify that cutting conditions are appropriate.
Distance compensation	Compensate an error in cutting length.
Set up	Specifies functions.
Sample cut	Performs cutting of characters "Cut" to determine whether or not the device is faulty.
Dump execution	Plots data sent from the host computers in the ASCII data format.
List	Plots tool conditions or function setting conditions.
Display	Changes over the language to be displayed on the LCD.

■ Setting function

The setting feature is used to set to adapt the function to the specifications of host computer and specify operations of the plotter. The settings are stored in memory even when the power is turned off.

Item to be set	Explanation of function
INTERFACE	Establishes communication conditions in accordance with the host computer in the case where RS-232C interface is used.
CUT MODE	Specifies cutting quality.
ORIGIN SELECT	Establishes an origin in accordance with the command specification of application software used.
ROTATION	Specifies the location of origin and direction of coordinate axis.
DIVISION CUT	Cuts data that exceeds the sheet width with divided appropriately.
HALF CUT	Cuts data in broken lines.
POUNCING	Cuts data using the pouncing function that is optionally available.
DISTANCE	Specifies the maximum response value of the command to read out an effective area sent from the host computer.
REMOTE DISPLAY	Specifies the method to display under the remote mode.
SHEET SENSOR	Turns off the sheet sensor function.
UP SPEED	Specifies a traveling speed to be employed when the tool is raised.
JOG STEP	Specifies an amount of travel corresponding to a press on a jog key (arrow key).
MARK DETECT	Cuts the contour of a picture pattern printed.
MM/INCH	Changes over the unit of length to be displayed.
DUMMY CUT	Specifies the dump cutting operation.
SHEET SETTING	Specifies the type of sheet to be used.
SORTING	Specifies the function sorting cut data.
SETUP RESET	Initializes the current setting.

Operation of keys corresponding to the functions

Functions are selected and entered by operating the corresponding keys as described below.

■ Functions invoked with specific keys

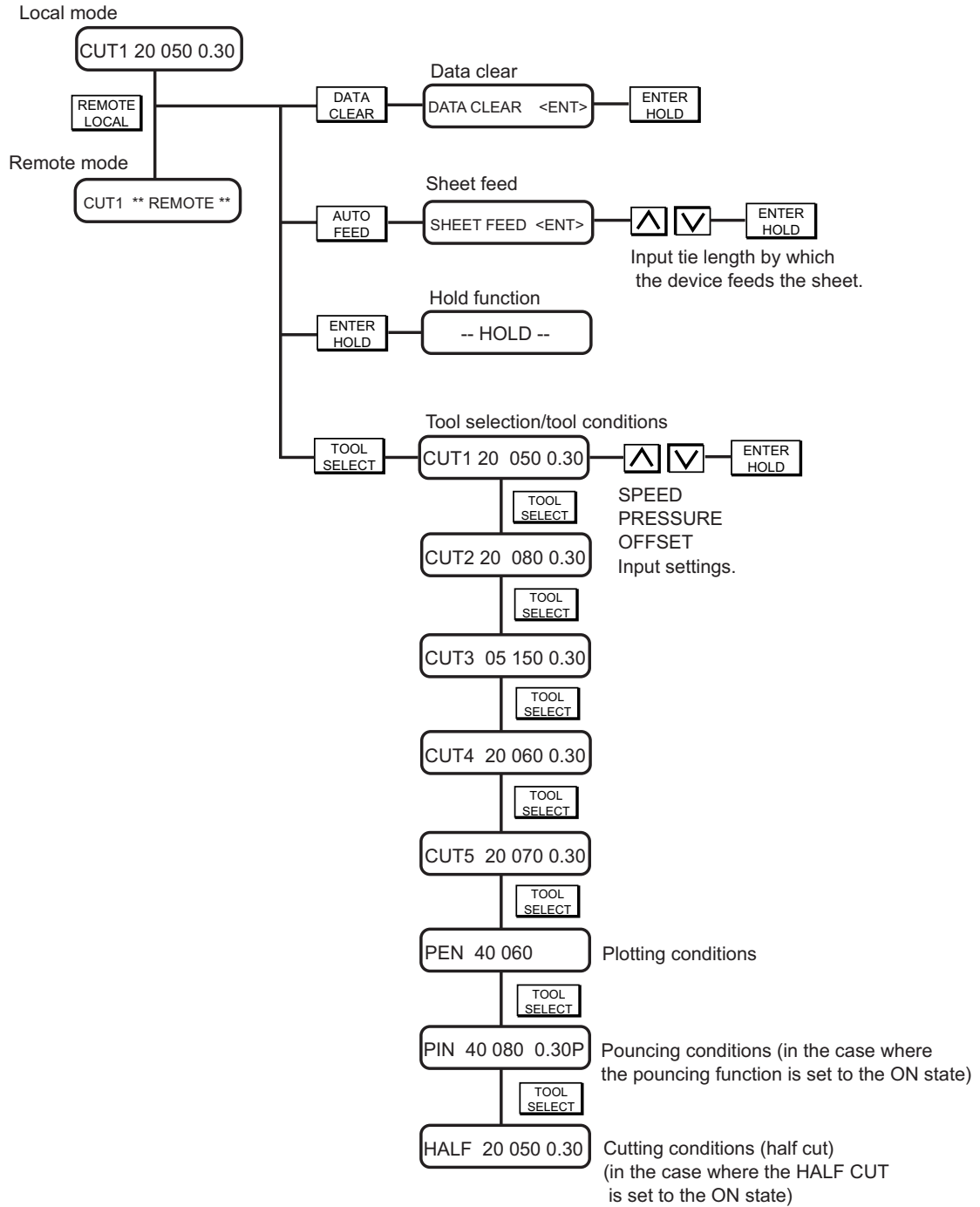

■ Jog function

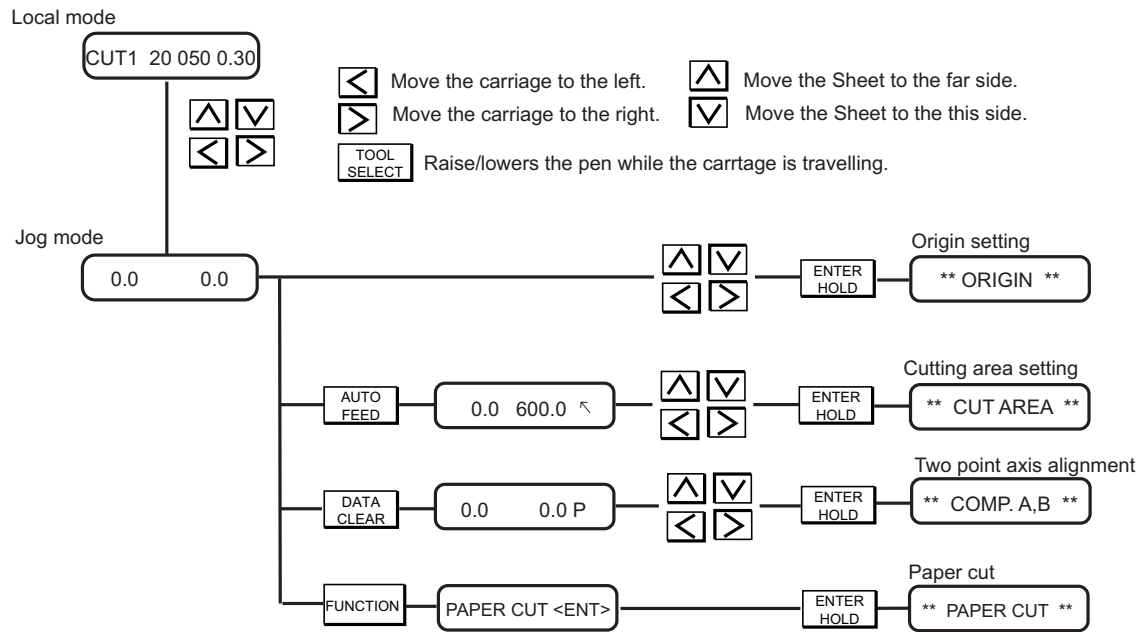

■ Function

Local mode

CUT1 20 050 0.30

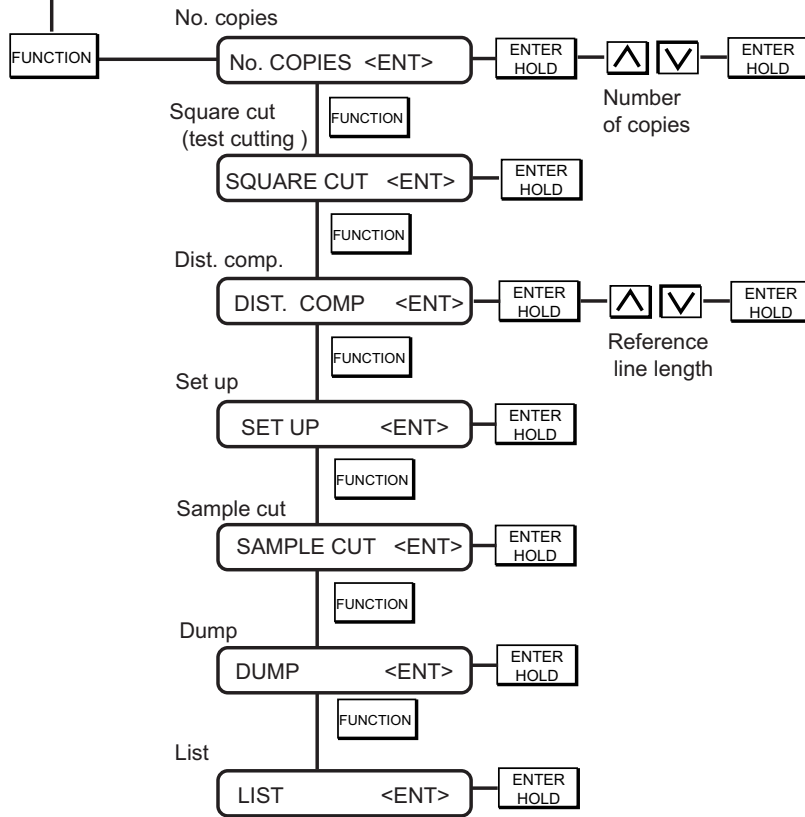

Setting Function

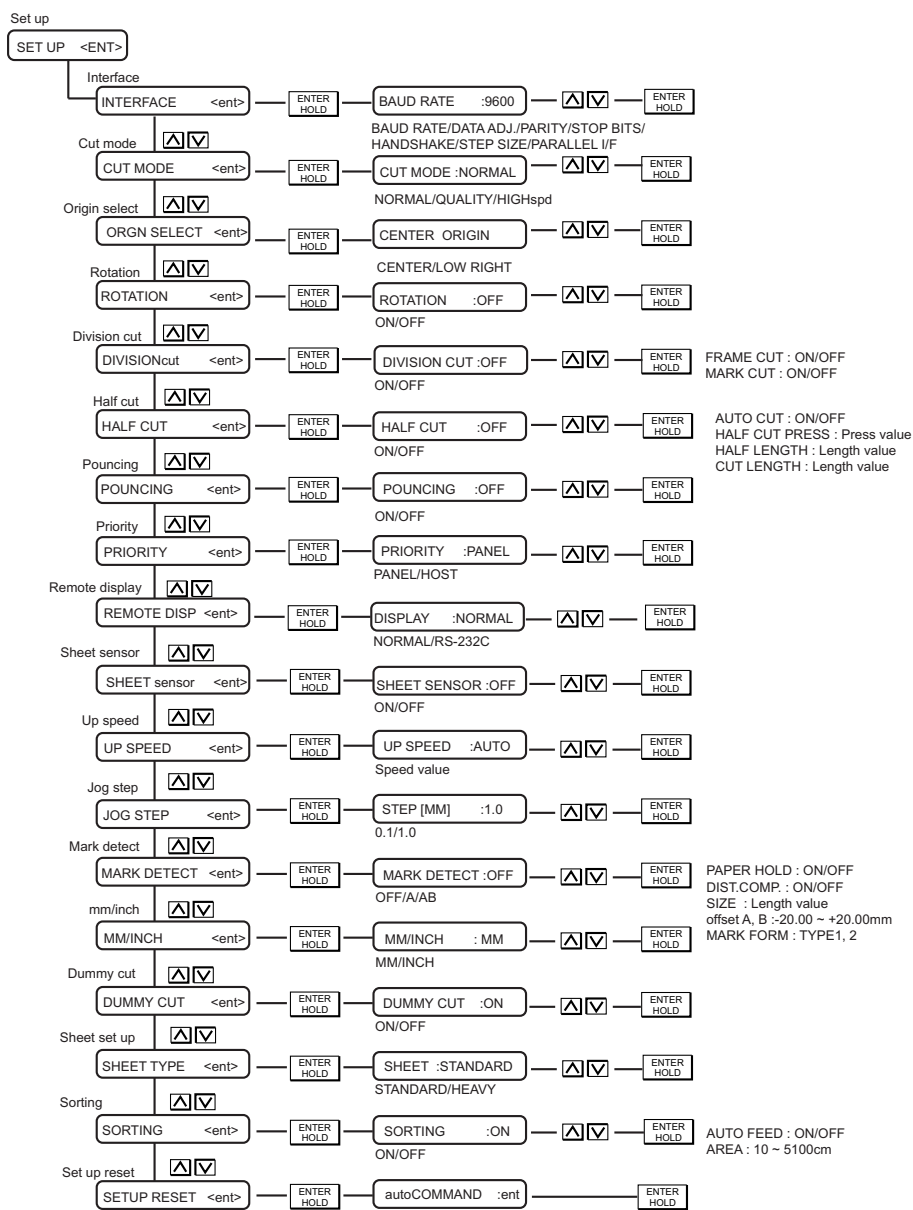

EXPLANATION OF FUNCTIONS

Settings of the functions and detailed explanation of the functions are described below.

Cutting area

An area in which the device performs cutting (plotting) is specified.

The area that has a diagonal line extending from the origin and a given UL (upper left) point is the effective cutting area. If you tilt the sheet set lever toward you, the cut area specified will be cleared. **CAUTION!** * Be sure to specify an upper left point in the area that is located in the normal direction from the origin.

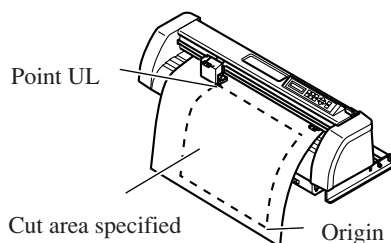

- * Be sure to specify an upper left point in the area that is located in the normal direction from the origin.
- * Be sure to set an origin in the cutting area. If you establish an origin outside the cutting area, an operation error will result.

Two-point axis alignment

To cut the contour of a printed matter that has been position on the machine, the axis of the printed matter has to be aligned with that of the machine.

Axial inclination (θ) is corrected between the origin and correction point specified.

To clear the alignment point, raise the sheet set lever.

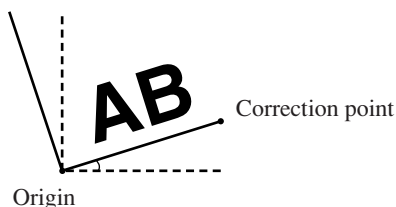

■ Setting value

–45° to 45°

Paper cut

The sheet is cut off at the current location of the tool.

To perform the paper cutting, set the tool condition to “HALF.”

The device will conduct paper cutting with the pressure specified in the tool conditions.

For the paper cutting, the sheet will be cut up to the location 15 mm outside each of the pinch rollers.

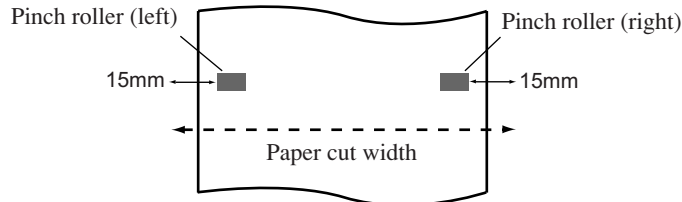

Digitization operation

Coordinates of the plotted figure as from the origin are displayed on the host computer.

When the device receives a digitization command (DP) from the host computer, the digitization operation is enabled.

To conduct digitization, install a sheet with patterns to be used to specify points on the device.



- **The digitization operation is only enabled in the case where the application software that incorporates a digitization function. Refer to the instruction manual for the application software for how to use the digitization function.**

PEN ** REMOTE **

** DIGITIZE **

100.1 250.5

PEN ** REMOTE **

- 1) **Set the device in the remote mode. The device receives the digitization command from the host computer.**

The display on the LCD will change as illustrated on the left.

- 2) **Move the pen with a jog key until the pen tip reaches a given point of the pattern.**

Coordinates as from the origin will be displayed.



- **If you specify the step unit to a smaller value using the jog step function, you may specify the desired point with increased accuracy.**

- 3) **Press the  key.**

The information on the point on which the pen tip rests will be sent to the host computer.

Data clear

The device terminates cutting (plotting) of the current data, and starts cutting (plotting) of new data. If you want to stop cutting (plotting) of the current data before the device completes it, you have to clear the data received.



- **After the execution of data clearance, the received data will remain in the receiver buffer. It is, therefore, possible to cut (plot) the data in repetition using the plural sheet cutting function.**





DATA CLEAR <ENT>

Execute the data clearance and set the device in the remote mode. When the device receives new data from the host computer, it will cut (plot) the new data.

Sheet feed

The sheet is fed by the length to be used.

In the case where a roll sheet is used or a long-dimension data is to be cut (plotted), the sheet has to be fed by the length to be used to provide an allowance. In addition, displacement of the sheet can be checked by feeding the sheet.

Press the  key. Press the  or  key to set the feed amount. When the  key is pressed, the sheet is fed from the origin.

■ Setting value

For “mm”: 0.1 m to 51.0 m (in increments of 0.1 m)

For “inch”: 1 to 167 feet (in increments of 1 ft.)

If the sheet is too short in length to enable feeding of the sheet by the specified length, the following display will appear on the LCD.

If this display appears on the LCD, press any key to reset it.

** STOP : 0.3m **



- **To interrupt the sheet feed, press the  key.**

Then, the following display will appear on the LCD.

** STOP : 1.6m **

Hold

In the case where the sheet slips out of position during cutting (plotting) of long-distance data, the hold function is used to put the device on hold to allow the operator to correct the displacement of the sheet and re-start the operation after the completion of correction.

A press on the  key during cutting (plotting) will put the device on hold.



- **Under the local mode, the ENTER/HOLD key has to be held pressed for approximately 1.5 seconds.**

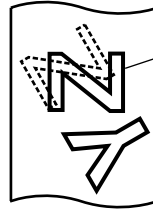

Data after the correction of displacement of sheet



- * **Be sure to execute the hold function at the boundary between characters.**
If you execute the hold function while the device is cutting (plotting) a line segment of a character, the starting point and end point of cutting (plotting) will not meet.
- * **When correcting the displacement of the sheet, move neither the carriage nor the pinch rollers. If they are moved out of position, a damage to the device or an error will arise.**
- * **After the device is put on hold, lower the pinch rollers. If they are held raised, the hold function cannot be terminated.**

Half cut

When cutting the sheet according to data, the device cuts the data in broken lines without cutting it out.

In addition, the “auto cut” can be specified to cut out the sheet automatically upon completion cutting. To conduct the broken-line cutting, place the tool on this side of the tool holder and set the cutting conditions to “HALF.”



- * **For the broken-line cutting, use the cutter (model: SPB-0001, a set of three cemented carbide blades) that is optionally available.**

■ Setting value

Half cut (Setting of broken-line cutting)	: ON, OFF
Auto cut (Automatic cut-off of sheet)	: ON, OFF
Half cut press (Cutting pressure to cut out the sheet)	: 0 g to 80 g
Half cut length (Length of sheet to remain after cutting)	: 0.1 mm to 5.0 mm
Cut length (Length by which the sheet is cut out.)	: 5 to 150 mm



- **Reference value**

Cutting conditions and broken-line cutting conditions for the case where the sheet that weighs 65 kg is cut are as follows:

<Cutting conditions>

- SPEED 40 cm/s
- PRESSURE 40 g
- OFFSET 0.30 mm

<Broken-line cutting conditions>

- Half cut press 0 g
- Half cut length 0.5 mm
- Cut length 10 mm

Set the “ CUT LENGTH” to a comparatively small value when cutting a character with many strokes or small-size character.

Side view of the sheet

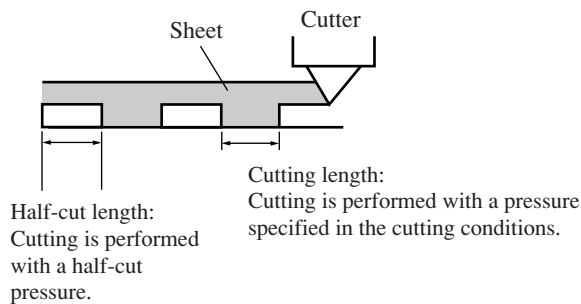

■ **Auto cut**

In the case where the cutting conditions is set to “HALF” and any of the following conditions is satisfied, the device will cut the sheet of paper.

- Before executing the Not Ready Command (NR)

The location at which the auto-cut is performed: The location found by adding 25 mm to the maximum cutting position in A-axis.

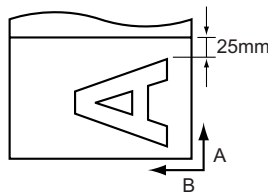

- When the origin is renewed in the +A direction using the Page Change Command (ZT0; !PGn;). When the device does not receive any command for ten seconds or more after the completion of cutting (plotting).

The location at which the auto-cut is performed: The top of the next page.

No. of copies [No. COPIES]

This function is used to perform cutting (plotting) of the received data on two or more sheets.

The device stores the received data in the receiver buffer to enable cutting (plotting) in repetition on as many as 999 sheets.

When the device receives new data, the data stored in the receiver buffer will be updated.

■ Setting value (input of numeric data)

1 to 999 (sheets)

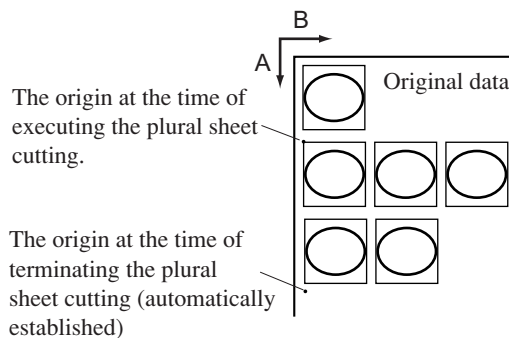

The locations of copies for second cutting (plotting) and beyond are to be allocated according to the size of the original data.

Lengthwise and widthwise interval between copies of the original data is 1 mm.

After the completion of copying, the location of origin will be updated.



- * **If the plural sheet cutting is executed immediately after cutting under the remote mode, the data will be cut (plotted) overlapped. To avoid this trouble, re-set an origin.**
- * **While the device is executing the plural sheet cutting, it ignores data sent from the host computer. To send plural pieces of data from the host computer to the device, the data has to be sent while providing an interval of 10 seconds or more between any two pieces of data. If two pieces of data are sent from the host computer to the device within 10 seconds, the two pieces of data will be subjected to the plural sheet cutting.**
- * **If the origin updated inside the device during setting up the two-point axis alignment fails to fall within the effective cutting area, the device will not cut the data.**
- * **The device cuts divided cut data by the specified number of sheets without dividing the data.**
- * **In the event that any error appears on the LCD, refer to Chapter 4.**

Test cutting [SQUARE]

In the case where you have changed the type of sheet or tool and cutting conditions have been changed correspondingly, the test cutting function is used to execute test cutting to check that the cutting conditions such as SPEED, PRESSURE and OFFSET are appropriate.

In the test cutting, the device cuts two different types of squares.

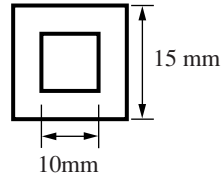

- Change the settings for cutting conditions, if necessary, depending on how the squares are cut.
- The device executes the [SQUARE] at the current tool location.

Distance compensation [DIST. COMP]

In the case where the device feeds the sheet by a long distance, an error in the cutting length can arise according to the sheet thickness. The distance compensation function is used to correct the error.

Three different compensation can be stored.

DIST. COMP. <ENT>



S1 : 1.0000 1.0000

S2 : 1.0000 1.0000

S3 : 1.0000 1.0000

1) Press the **FUNCTION** key to select [DIST. COMP].

2) The currently selected enter number and scale setting will appear on the LCD.

Press the  or  key to select the number to be entered or used.

3) Press the **ENTER HOLD** key.

The reference length (unit: mm) that was used in the previous correction will appear on the LCD.

A*1.000 B*1.000

A=500 B=200

A=1000 B=200

A=1000 B=200

If no distance compensation has been performed, the minimum reference length will appear on the LCD.



- The length display shown below means that the [DIST. COMP] was executed using the mark detecting function or the [DIST. COMP] was changed over to the [MM/INCH]. A press on the \wedge or \vee key will enable the inputting of a numeric.

A=---- B=----

4) Input a reference length.

Select the reference lengths (unit: mm) in directions A and B using the \wedge or \vee key. Specify the reference length with the $\boxed{\text{ENTER HOLD}}$ key.



- If you change the reference lengths in direction A and B, the distance correction value will be cleared.

If you only change the distance compensation number, press the $\boxed{\text{END}}$ key.

5) The device plots an adjustment pattern.



- * If no sheet is placed on the device, or the sheet size is too small to plot a reference length, the device will not conduct plotting and proceed to the correction value inputting stage.

■ Compensation value

Find compensation values referring to the description given below.

Compensation value = Measurement of the OFF line – Reference length input

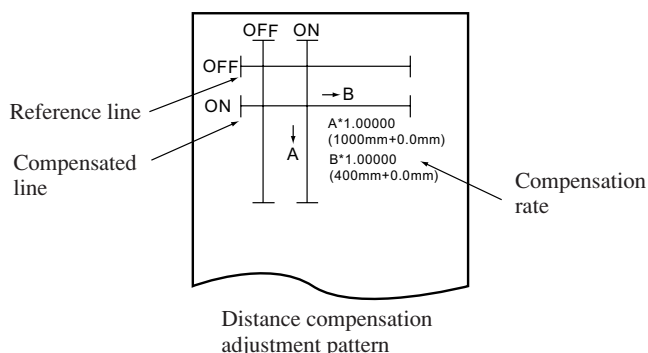

Example)

Reference length input = 1000 mm

Measurement of the OFF line = 999.0 mm

$999.0 - 1000 = -1.0$ mm

As a result, the compensation value to be input will be “-1.0 mm.”

A=0.0 B=0.0

A=1.0 B=0.0

A=1.0 B=0.0

A=1.0 B=0.5

A=1.0 B=0.5

PEN 40 060

6) Upon completion of plotting, the device will give the current compensation value on the LCD.

7) Measure the ON line along A- and B-axis.

If any of the measurements of the ON lines differs from the corresponding reference value, input a compensation value.

If the measurements are same with the corresponding reference values, terminate the function with key.

8) Select the compensation values in A and B directions.

Select the compensation value using the or key and specify it with the key. After the completion of compensation, the device will enter the local mode.



- To reset the distance compensation function, input “0, 0” respectively to the compensation values for A- and B-axis.

■ Settings of reference lines (Make a choice and input it)

- For “mm”:

A-axis : 500, 1000, 1500, 2500 mm

B-axis : 60EX : 200, 400 mm

100EX : 200, 400, 600, 800 mm

130EX : 200, 400, 600, 800, 1000, 1200 mm

- For “inch”:

A-axis : 24, 36, 48, 60, 72, 96 inch

B-axis : 60EX : 6, 12, 18

100EX : 6, 12, 18, 24, 30, 36

130EX : 6, 12, 18, 24, 30, 36, 42, 48

■ Settings of compensation range (numerical input)

A-axis : $\pm 5\%$ (0.1 mm step)

B-axis : $\pm 5\%$ (0.1 mm step)

Sample cut [SAMPLE CUT]

In the case where the device fails to cut data correctly or the end point of cutting of a character fails to meet the starting point, the cause of such a fault can be checked up by cutting the characters “Cut.”

Cut

- In the case where the device is able to normally cut the characters “Cut” but fails to cut other data:
The host computer is faulty.
- In the case where the device fails to cut both the characters “Cut” and other data:
The device may be faulty. Contact your distributor.

Execution of dump [DUMP]

This function is used to cause the host computer to send data to the device, then cause the device to plot the communication conditions of the interface through which it receives the data, and finally cause the device to plot the data received in ASCII format.

To execute the dump, be sure to use a pen as the tool.

The dump can be executed with the interface to which the host computer is connected.



- To put the dump on hold, press the  key to change over the operation mode to the local mode and execute the data clearing (see page 3.10).
- An example of the dump output is given in Appendix C for reference.

Execution of list output [LIST]

With this function, the device plots tool conditions, communication conditions and functions setting conditions for your notes or for facsimile sending at the of maintenance.

Use a pen as a tool and plot on a leaf paper (A4 size paper in portrait orientation).



- An example of the list output is given in Appendix C for reference.

DISPLAY

This function is used to change over the language used to give displays on the LCD.

■ Setting value

- Japanese
- English
- German
- French
- Spanish
- Italian
- Portuguese

Setting communication conditions [INTERFACE]

This function is used to establish communication conditions of the RS-232C interface.

Settings of the communication conditions differ with the command (AUTO, MGL-I c1 or MGL-II c) specified using the command change-over function.



* **If you have changed the step size, be sure to raise the pinch rollers using the sheet set lever and re-load the sheet on the device.**

■ Setting value (Make a choice and input it)

Baud rate : 1200, 4800, 9600, 19200, 38400 (bps)
Data bit : 7, 8 (bit)
Parity : NON, EVEN, ODD
Stop bit : 1, 1.5, 2 (bit)
Handshake : HARD, SOFT, X-PRM, SOFT
Step size : 0.025, 0.01 (mm)
Parallel : NORMAL, BUFFER
Close time : 3 to 60 (sec.)

[PARALLEL]

This designates the operating procedure of the 8-bit parallel interface.

NORMAL : The device receives data and performs cutting at a time.

BUFFER : The device starts cutting under any of the following states.

- When the device receives 800 Kbytes data under the remote mode
- When the device received certain data and has not received additional data for two seconds or more.

Guide for the case where the operating procedure of the 8-bit parallel interface is set to [BUFFER]:

- In the case where the host computer offers high-speed data transfer and it is desired to reduce the time of the host computer occupied by data transfer
- In the case where the device performs cutting intermittently since it receives data and performs cutting simultaneously ([NORMAL]). In the case where the performance of the device when conducting cutting according to the received data and that when conducting the plural sheets cutting independently from the host computer differ from each other.

[Close time]

The minimum waiting time is required until the subsequent data is received.

The setting range is 3 to 60 seconds. If no data is received when the established waiting time has elapsed after the completion of cutting, the device will judge that one piece of data has completed to enable discrimination between the completed data and the subsequent data.

Guide to the establishment of close time.

- Breakpoint in object data to be cut by piece-cutting feature
- Waiting time Required to start division-cutting
- Waiting time retired to start outputting a sorting command

Change-over of cut mode [CUT MODE]

This function is used to specify the cutting quality.

■ Setting value (Make a choice and input it)

QUALITY : The device conducts cutting giving priority to the cutting quality.

NORMAL : The device conducts cutting normally.

HIGHspd : The device conducts cutting quickly.



• **Select the “QUALITY” in the following cases:**

- a) Where a character of which size is 10 mm or less is to be cut
- b) Where a picture pattern or character that have many sharp curves is to be cut
- c) Where minute cutting is to be performed

It should be noted, however, that a pattern with a rugged edges may be finished in the case where the data sent from the host computer is excessively minute. It is recommended in such a case to select the “HIGHspd” for smoother finish.

Rotation [ROTATION]

This function is used to specify the location of origin and direction of the axis of coordinates according to the application software to be used.

■ Setting value (Make a choice and input it)

- ON : The device rotates the coordinate axis and relocates the origin at a time.
- OFF : The device does not perform rotation of the coordinate axis.

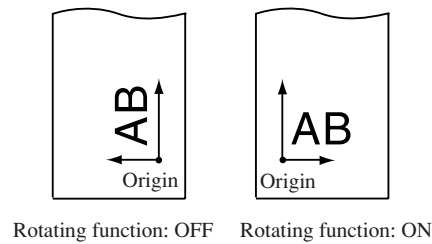

After the sheet detection, the carriage will stop at the origin.

■ Axis of coordinates

The device has four different axis of coordinates according to how the sheet loading direction and the angle of rotation of the coordinate axis determined by the rotating function are combined.

< 0° ROTATION >

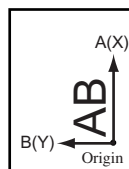

The sheet is loaded on the rear of the device.
Rotation: OFF

< 90° ROTATION >

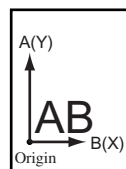

The sheet is loaded on the rear of the device.
Rotation: ON

< 180° ROTATION >

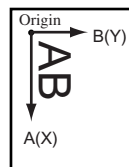

The sheet is loaded on the front of the device.
Rotation: OFF

< 270° ROTATION >

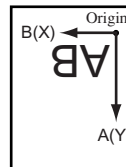

The sheet is loaded on the front of the device.
Rotation: ON

Division cut [DIVISION CUT]

In the case where the data on cutting exceeds the sheet width, the device is able to cut the data with divided appropriately. While the device is engaged in division cut, it will ignore other data sent from the host computer. In the case where the rotating function is set to the ON state, the result will be as illustrated below.

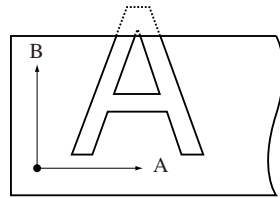

Rotating function: OFF

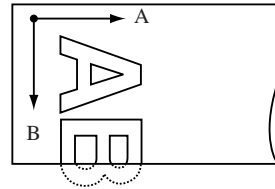

Rotating function: ON

■ Setting value (Make a choice and input it)

DIVISION CUT : ON, OFF

FRAME CUT : ON, OFF

MARK CUT : ON, OFF

In the case of the frame cutting or adhesion allowance marking, the device will perform cutting based on the size of data on cutting. If the host computer designates the frame cutting and sends data to the device, the frame will align with the adhesion allowance marks to facilitate adhesion.

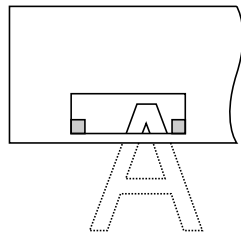
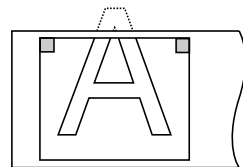

Frame cutting is not specified on the host computer side.

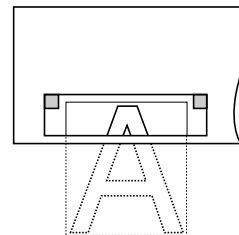
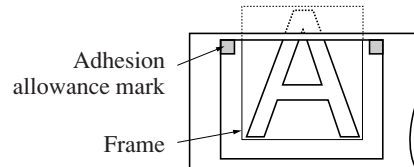

Frame cutting is specified on the host computer side.



* The sheet has an adhesion allowance of 1 cm. It is, therefore, necessary that the effective cutting area shall be wider than 1 cm at all times.



- **In any of the following case, the device will cut neither the frame nor the adhesion allowance marks.**

- a) Where the capacity of data is larger than the receiver buffer capacity
- b) Where the origin updating command is contained in the data on cutting
- c) Where the two-point correcting function is specified
- d) Where the width of effective cutting area is 1 cm or less
- e) Where the device cuts the test data stored in it

The following display will appear on the LCD panel.

****END DIVISION****

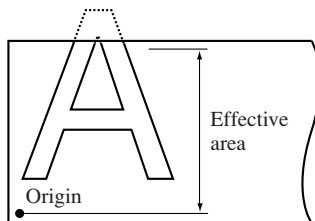

**** OFF SCALE ****

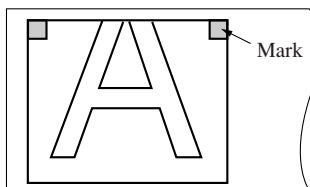

****DIVISION** XXs**

The time required to cut the frame and adhesion allowance mark will appear on the LCD panel.

CUT1 DIVISION

- 1) **Set the [DIVISIONcut] to the ON state.**

- 2) **Send data from the host computer to the device.**

If the data exceeds the cutting area, the display given on the left will appear on the LCD.

- 3) **Upon completion of cutting, wait until the device cuts the frame and adhesion allowance mark.**

Remaining time until the completion of cutting the frame and mark

- 4) **Upon completion of the frame cutting, the device will enter the local mode.**

The display shown on the left will appear on the LCD panel.



- * **Do not raise the clamp lever while the LCD panel gives the aforementioned display. If you raise the clamp lever, the machine will terminate cutting.**

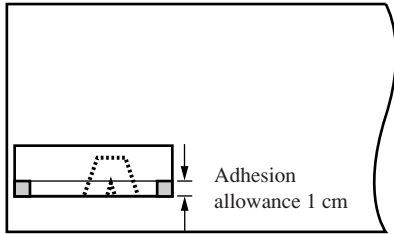

CUT1 20 050 0.30

5) Establish a new origin.

Move on the sheet using the jog key (arrow key) to establish an origin.

If the sheet has no space for cutting, replace the sheet with a new one.

6) Press the  key to set the device in the remote mode.

Feed the sheet by the maximum sheet length required by data on cutting and start cutting.

If the sheet is not fed or the sheet is not sufficiently long, replace the sheet with a larger one in the aforementioned step 5) .

7) Carry out steps t and y in repetition.

Repeat those steps continuously until there is no data that exceeds the sheet width.

Upon completion of those steps, the LCD display will give the tool conditions.

POUNCING [POUNCING]

Pouncing is a perforated pattern. The pattern is as described below;

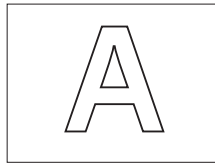

Standard cutting

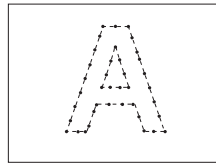

Pouncing

• To use special pouncing tool

In order to create perforated pattern, pin (pouncing tool) and paper must be used.

■ Setting value (Make a choice and input it)

OFF : The pouncing function is rendered ineffective.

ON : The pouncing function is rendered effective.

■ Setting of the pouncing conditions

SPEED : 1 to 10cm/s(1cm/s step)

15,20,25,30,35,40,50,60,70,80cm/s

PRESSURE : 10 to 300(g)

Dot interval : 1 to 100 (mm)

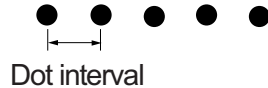

- * The use of pouncing pattern is to mark the position for signs applying marking power of the pounced paper.

Command priority setting [PRIORITY]

This function is used to specify the setting that is given priority in terms of the following commands; either the setting established on the device or that established on the host computer is given priority.

Command name	Command
Pen selection command	SP:
Pen lowering speed setting command	VS:
Pen lifting speed setting command	ZA:
Acceleration setting command	AS:
Pen pressure setting command	FS:, ZF:
Blade-tip correction setting command	ZO:

■ **Setting value (Make a choice and input it)**

PANEL : The device operates using the setting established on its operation panel.

HOST : The device operates using the setting established by the command setting function of the host computer.

Remote display [REMOTE DISP]

This function is used to specify the display to be shown on the LCD panel under the remote mode. Normally, [NORMAL] is specified.

■ **Setting value (Make a choice and input it)**

NORMAL : The tool specified and remaining amount of data on cutting appear on the LCD panel. The remaining amount of data will increase at the receipt of data from the host computer, or decrease upon execution of cutting.

RS-232C : Status of signal conductor of RS-232C appears on the LCD panel. This is helpful in case of a trouble in connection.

In the case of NORMAL

In the case of RS-232C

CUT1 * 1254KB *

RS1 CS0 DR0 ER0

Device pin number	JIS C6361	RS-232C	CCITT V.24	etc.	Direction	Remarks
4	RS	CA	105	RTS	out	Normally ON (1)
5	CS	CB	106	CTS	in	Normally ON (1)
6	DR	CC	107	DSR	in	Depends on the interface cable
20	ER	CD	108/2	DTR	out	Normally ON [HARD]. OFF: In the case where the buffer is almost full at the time of a handshake.

Sheet sensor [SHEETsensor]

The sheet sensor detects the presence/absence of a sheet and the sheet length. Two sheet sensors are mounted on the platen.

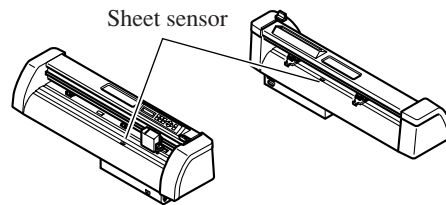

In the case where any of the following types of sheet is used, the sheet sensors will not be able to detect it to give the error message shown below.

- **Transparent sheet that does not reflect the light coming from the sheet sensor.**
- **The sheet of which wrong side is black that does not reflect the light coming from the sheet sensor.**

**** NO SHEET ****

In this case, cutting is enabled by setting the [SHEET SENSOR] function contained in the SET UP of FUNCTION to OFF.

■ Setting value (Make a choice and input it)

OFF : The sheet sensor function is rendered ineffective.

ON : The sheet sensor function is rendered effective.



- * **In the case where the [SHEET SENSOR] function is set to the OFF state, a cutting area has to be established since the device may cut data that exceeds the sheet or continue cutting if there is no sheet left.**

Tool lifting speed setting [UP SPEED]

This function is used to establish a traveling speed of the sheet and carriage to be employed when the tool placed in the carriage is in the raised position.

If a lower speed is specified, displacement of the sheet will be eliminated at the time of long-distance feed.

■ Setting value (Make a choice and input it)

5, 10, 20, 30, 40, 50, 60, 70, 80, AUTO (cm/s)



- **If the [AUTO] is specified, the SPEED setting established in the tool conditions will be employed. It should be noted, however, the minimum SPEED setting will be 10 cm/s.**

Change-over of jog steps [JOG STEP]

This function is used to select the amount of travel of the carriage and sheet when the jog key (arrow key) is pressed.

In the following cases, accurate positioning will be enabled.

- When performing two-point axis alignment.
- When performing digitization.
- When establishing an origin at a desired location with accuracy.

■ Setting value (Make a choice and input it)

For “mm”:

1.0: A press on the jog key will move the carriage and sheet by 1.0 mm.

0.1: A press on the jog key will move the carriage and sheet by 0.1 mm.

For “inch”:

1/16: A press on the jog key will move the carriage and sheet by 1.0 mm.

1/254: A press on the jog key will move the carriage and sheet by 0.1 mm.

Dummy cut [DUMMY CUT]

With this function, the device operates in such a way as to orient the blade tip to a predetermined direction when starting cutting. Execute dummy cut when you have taken the following procedure.

- When selecting a tool (CUT1, CUT2, CUT3 or HALF)
- When establishing cutting conditions
- When selecting the cutter and executing paper loading

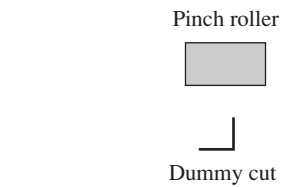

Execute dummy cut this side of the pinch roller that is located near either end of the sheet as observed from the current location of the carriage.

Set the dummy cut function to OFF if you want to protect the sheet when plotting a cut-out character.

■ Setting value

The setting will be stored in memory even if the power is turned off.

ON, OFF



* **The initial setting of the dummy cut function is ON.**

If you have set the dummy cut function to OFF, execute test cutting to adjust the blade-tip direction in prior to cutting.

Mark detecting function [MARK DETECT]

This function is used to automatically detect a registration mark.

Correct the inclination of the sheet loaded on the device, origin of plotting and distance between registration marks. Then, cut the contour of a picture pattern printed on a seal.

The following types of the registration marks are to be read.

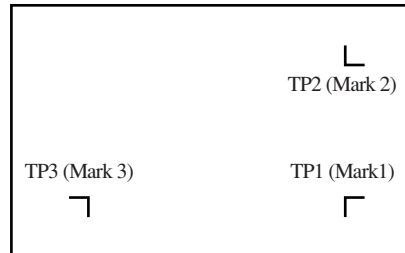

MARK FORM: TYPE1

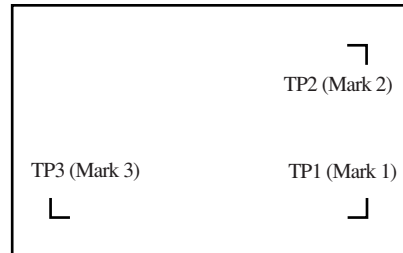

MARK FORM: TYPE2



- * To make the distance between registration marks equal to the cutting length, input the distance between printed marks found by the mark detecting function. When you input the aforementioned distance, the setting established for the distance compensation function contained in the FUNCTION will automatically change correspondingly. If you change the latter setting, the former will also change correspondingly.
- * If you turn the sheet set lever away from you to remove the sheet, the settings of sheet inclination, origin location and two-point axis alignment will be cleared. In this case, however, the setting of the distance compensation will remain in memory.
- * Once the device detects marks, the origin will be established at the location of TP1. If you establish another origin at a different location using the jog key (arrow key), the origin will be rendered effective.
- * The rotating function is rendered ineffective.

Detecting a registration mark on a sheet

The printed seal (hereinafter referred to as the “sheet”) are required to be printed with marks that satisfy the following requirements to allow the device to detect the registration mark as well as the length of A- and B-axis.

If not, the device will not produce a desired result.



- * **The registration mark described in this paragraph means a registration mark that is used to detect the sheet inclination and the length of A- and B-axis. It is different from a mark for trimming.**
- * **The mark shall be printed in black against the white background.**
- * **The line width of mark shall be equal to or more than 0.3 mm and equal to or less than 0.5 m.**
- * **To detect the registration marks, no stain or print image should be in between the marks.**
- * **TP3 is used for the distance correction in widthwise direction of the sheet. If the distance correction in widthwise direction of the sheet need not be made, the detection of TP3 may be omitted.**

TYPE1

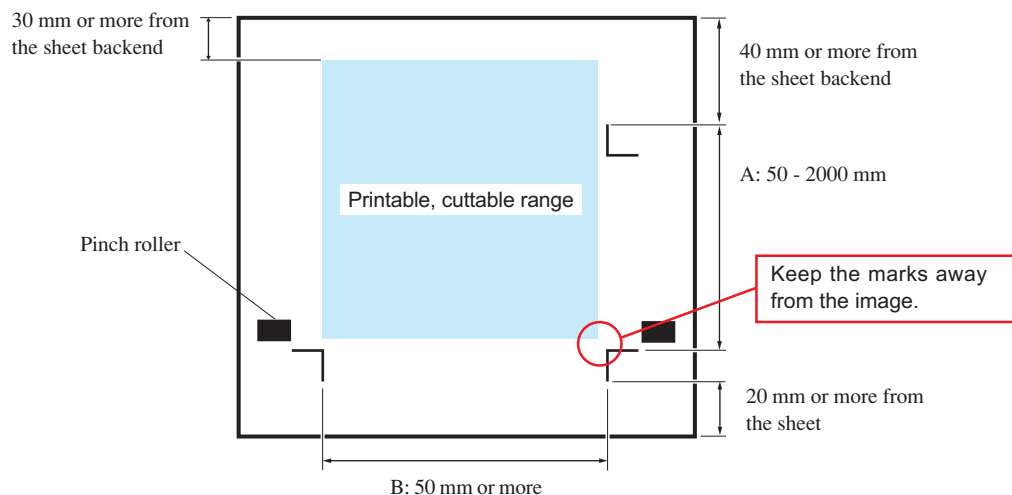

TYPE2

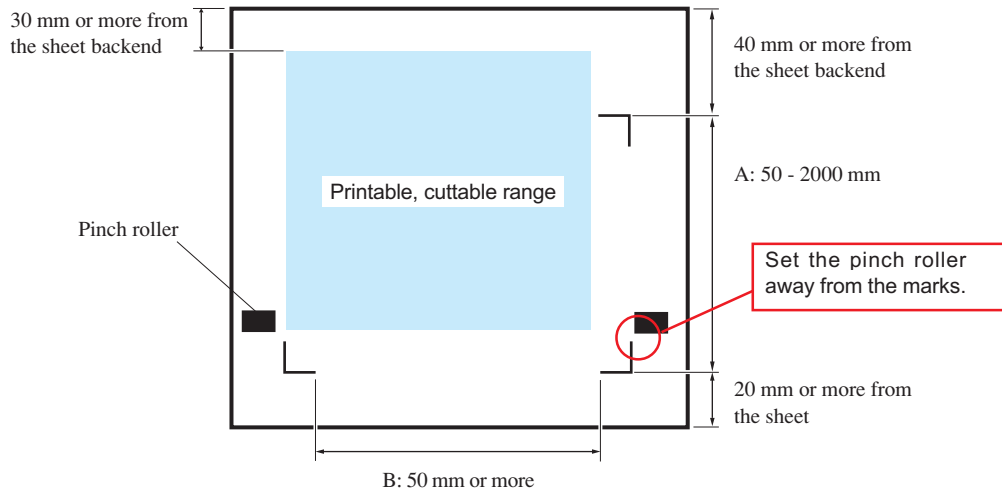

■ Operation settings for detection of marks

The settings of the following three functions are specified when detecting a mark.

Function	Setting	Description
MARK DETECT	OFF	This setting is specified with cutting a normal sheet instead of the contour of a pattern.
	A	Only marks in direction A (TP1-TP2) will be detected. In the case where two or more sheets (same in type and mark-to-mark distance in direction A) are to be cut, the mark detection B may be cancelled.
	AB	Marks in directions A and B (TP1-TP2-TP3) will be detected. This setting is specified when the sheet type is changed.
PAPER HOLD	ON	The sheet clamps mounted on the carriage hold the sheet to facilitate the mark detection.
	OFF	The sheet clamps are not used for the mark detection. If the sheet clamps are not used, the clamp detection may fail.
DIST.COMP.	ON	This sheet is specified in the case where the distance between printed marks is different from that between marks in terms of data.
	OFF	The device will not conduct the distance compensation. Once the distance compensation is executed, it may be cancelled provided that two or more sheets (same in type and mark-to-mark distance in direction A) are to be cut.

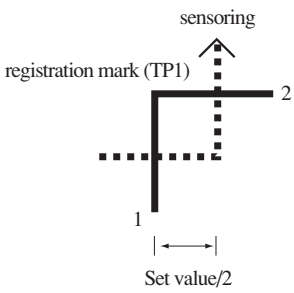
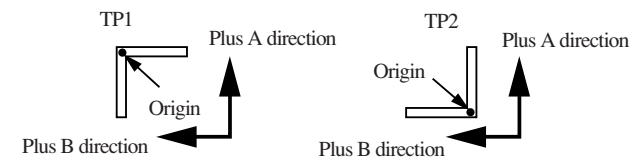
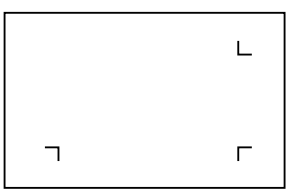
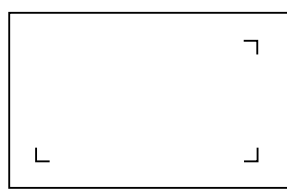
Function	Setting	Description
Size	4-20mm	<p>Setting the detection offset of the registration marks.</p>  <p>It is set the offset of the detection.</p> <p>After detecting line 1, set value/2 will be traveled to detect line 2.</p>
offsetA offsetB	-20.00 - +20.00mm	<p>Generally the origin will set the following position.</p> <p>However, the position of the origin may differ depending on the application software. In this case, it can be corrected.</p>  <p>When the origin becomes out of the effective cutting area, "ERR36 MARKdetect" will be appeared on the display. In the cause, please write the position of registration marks on the seat on a center side of the seat.</p>
MARK FORM	TYPE1 TYPE2	<p>Select either one of the following types of the registration mark.</p> <div style="display: flex; justify-content: space-around; align-items: flex-start;"> <div style="text-align: center;"> <p>TYPE1</p>  </div> <div style="text-align: center;"> <p>TYPE2</p>  </div> </div>

Method to detect registration marks

Registration marks are detected in two different ways; full-automatic detection and semi-automatic detection.

The semi-automatic mode is employed in the case where the registration marks 1 is not located at the lower right corner of the sheet.



* If the sheet is curling up, straighten the sheet.

* Use a sheet which has neither stains nor images in the area (A) located between TP1 and TP2 and in the area (B) located between TP1 and TP3.

Full-automatic detection of marks

It enables to compensate the difference in length of the registration marks between printed length and detected length (A and B). For this purpose, measure the length A and B beforehand. When you measure the length of in-between the following registration marks, the center of the registration marks is standard.

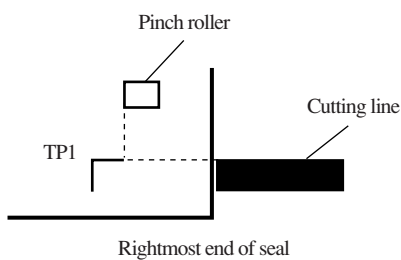
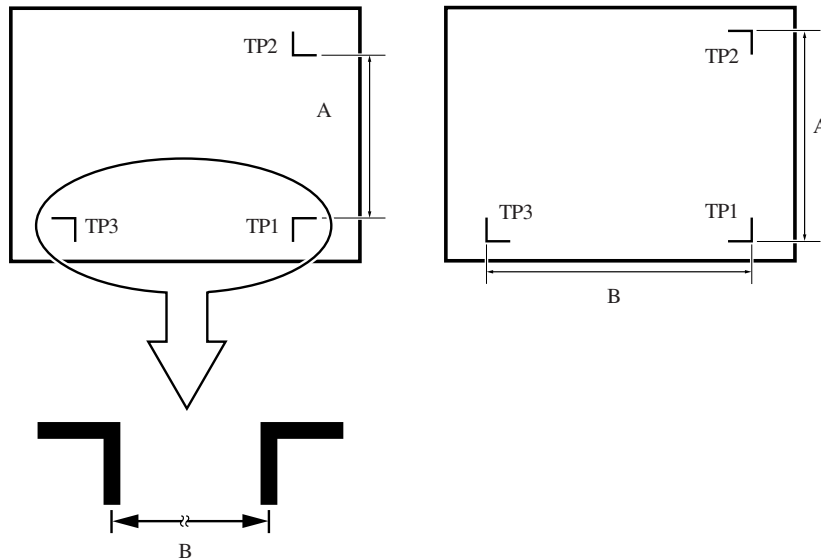

MARK FORM: TYPE1

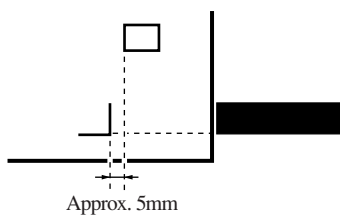

MARK FORM: TYPE2

1) Measure lengths A and B contained in the data to be output.

2) Place TP1 at a location as illustrated on the left.

Align the cutting line as follows:

- In the case where the “PEN” or “CUT” is specified in the tool conditions: To the pen line rubber side
- In the case where the “PIN” or “HALF” is specified in the tool conditions: To the pen line sponge side



- If it is impossible to place the registration TP1 at the location given in the sketch, proceed to the section describing “Semi-automatic registration mark detection.”

ROLL < R > LEAF

** MARK DETECT **

ERR36 MARKdetect

A = ***. * B = ***. *

A = ***. * B = ***. *

3) Taking care not to allow the sheet to slip out of position, turn the sheet set lever toward you.

Then, the pinch rollers will retain the sheet.

4) Press the  key.

The detection of TP1, TP2 and TP will start.





- **In the case where TP3 is not required to be detected, refer to “Operation settings for detection of marks.”**

If any of the marks cannot be detected, the message shown on the left will appear on the LCD. In this case, set the sheet properly.

5) After the marks are detected, lengths A and B will be shown on the LCD.





- **In the case where the [DIST.COMP] is set to “OFF,” the length-input screen will not appear on the LCD.**
- **In the case where the [MARK DETECT] is set to “A,” the screen on which length B is to be input will not appear on the LCD.**

If the lengths A and B displayed on the LCD are different from those contained in the data, input the latter using the  or  key and press the  key to enter the lengths.

If the lengths A and B shown on the LCD are same with those contained in the data, press also the  key.

When the  key is pressed, the screen on which length B is to be input will appear on the LCD.

6) Input length B.

If the length B shown on the LCD is different from that contained in the data, input the latter using the  or  key and press the  key to enter the length input..

If the length B that appears on the LCD is same with that contained in the data, press also the  key.

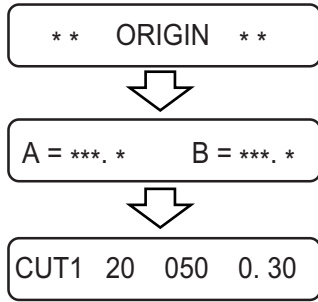

7) Set the origin.

Semi-automatic registration marks detection

In the case where mark 1 (TP1) is not located at the rightmost end of the sheet and cannot be laid out at the predetermined position described earlier, detect marks under the semi-automatic mode.

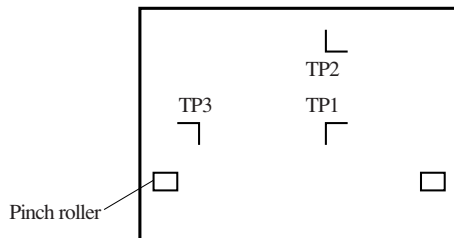

1) Place the sheet on the device and turn the sheet set lever toward you.

Then, the pinch rollers will retain the sheet and the device will perform the sheet detection.

2) Move the cutter blade tip with the jog key (arrow key) until it rests in the area illustrated on the left.

Moving area of the blade tip of cutter

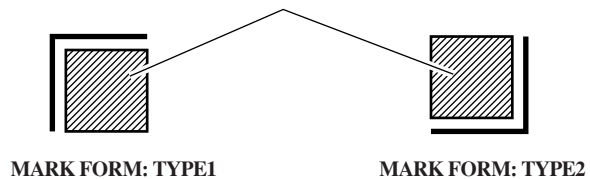

3) Press the  key.

Detection of registration TP1, TP2 and TP3 will start.



- **In the case where TP3 is not required to be detected, refer to “Operation settings for detection of registration marks.”**

If any of the marks cannot be detected, the message shown on the left will appear on the LCD. In this case, set the sheet properly.

A = ***. * B = ***. *

A = ***. * B = ***. *

** ORIGIN **







A = ***. * B = ***. *





CUT1 20 050 0.30

4) After the registration marks are detected, length (A) provided between TP1 and TP2 will be shown on the LCD.

As with the case where the full-automatic detection is performed, if the length A shown on the LCD is different from that contained in the data, input the latter using the  or  key and press the  key to enter the length input.

If the length A displayed on the LCD is same with that contained in the data, press also the  key.

5) Now, length (B) provided between TP1 and TP3 will be shown on the LCD.

If the length (B) shown on the LCD is different from that contained in the data, input the latter using the  or  key and press the  key to enter the length input.

If the length B displayed on the LCD is same with that contained in the data, press also the  key.

6) Set the origin.

Sorting [SORTING]

The sorting function is used to re-arrange the pieces of cutting data transmitted from the host computer to change the order of cutting. Pieces of data to be transmitted to the plotter by application will be arranged in the order in which they are created or edited.

If data read through a scanner is modified, the modified portion of data will be placed at the end of data. As a result, bag data cannot be plotted with one-stroke of pen. In such a case, the use of sorting function re-arranges the pieces of data in the correct order to enable one-stroke plotting.



- **The auto-feed function works to draw the roll sheet by the length of data to be cut and slacken the sheet. This function is effective when the [SORTING] is set to the ON state.**

When the sorting is effective, a block of data from the starting point of pendown to the ending point of penup is taken as a unit for cutting. After the completion of cutting of one block, another block of data of which starting point is nearest to the completed data will be cut.

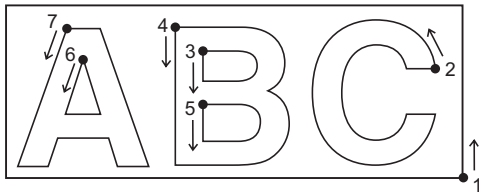

For data transmitted from the host computer, the starting position and cutting direction will not be changed.

● : Starting point of data = Starting point of cutting

Arrow : Direction of data = Cutting direction

Number : Block cutting order

When an area is specified, blocks of data that are located within the area are given cutting priority over the blocks located outside the area. Once all blocks of data located within the specified area have been cut, the area will be automatically expanded in the direction in which the sheet is fed to enable cutting on an area-by-area basis.

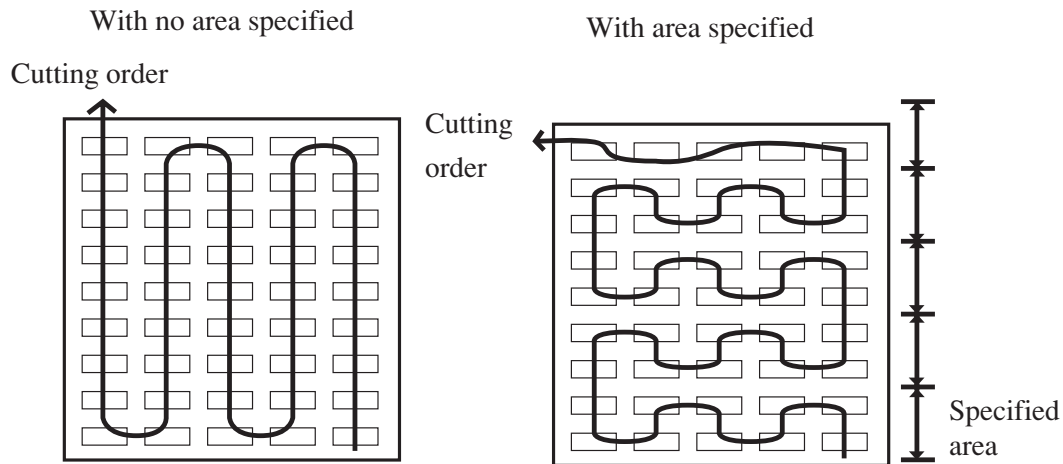

Sorting sequence

1. Data are being transmitted.

CUT1 ** 2KB**

2. Data transmission completes.

PLOT 5S

SORTING 1%

3. Auto-feed is executed.

Unprocessed data size in the receiving buffer is displayed. Cutting is not conducted. The processed line segments are stored in the sorting buffer.

Waiting time required to start cutting (Remaining time is displayed in seconds)

If no data is received during the waiting time, the counter starts counting down. The waiting time can be changed in the [CLOSE TIME] of the communication conditions.

Before starting cutting, the sheet is drawn by the length of data to be cut. If the sheet is not long enough to cover the whole data, the error shown below is displayed.

ERR15 AUTOFEED

After changing to a long sheet, transmit data or execute piece-cutting.

4. Cutting starts.

SORTING 10%

Data that has been already cut is displayed in percents.

5. Cutting completes.

CUT1 **REMOTE **

The plotter enters the remote mode.



- When the SORTING is set to the ON state, cutting will not start until the specified close time has elapsed after receiving all pieces of data to be cut. It should be noted, however, that received pieces of data are sorted and cut in the following cases.
- When the sorting buffer is full of data (approximately sixty thousand line segments)
- When executing a command to change cutting conditions (including pen number, speed and pressure)
- When executing a feed command or origin change command

Method to Sorting

SETUP <ENT>

SORTING <ent>

1. Press the key several times until [SETUP] is displayed. Press the key.

2. Press the key several times until [SORTING] is displayed. Press the key.

3. Press the or key to select [ON] or [OFF] of the sorting. Press the key.



- When the [OFF] is selected, the sorting setting is finished and the operation mode is restored to the LOCAL mode.

AUTOFEED : ON

4. Press the or key to select [ON] or [OFF] of the auto-feed to be performed before cutting. Press the key.

AREA : 10cm

5. Press the or key to select the area management function. Select [OFF] or establish a value in the range of 10 to 5100 cm (in increments of 10 cm). Press the key.

SORTING <ent>

6. The operation returns to Step 2.



- * The settings established will be stored in memory even when the power of the device is turned off.
- * Changing the setting will clear data that is stored in the receiving buffer.
- * When the sorting is set to the ON state, the receiving buffer size will be decreased to 1 MB.

mm/inch [MM/INCH]

This function is used to change over the unit of length.

■ Initial setting

Unit = mm

■ Setting value

mm/inch

Sheet setting [SHEET SET]

In the case where a heavy sheet or wide sheet is to be used, the sheet setting is performed using the sheet setting function to avoid displacement of the sheet.

In the case where the [SHEET SET] is set to “HEAVY,” the maximum speed that can be specified will be 20 cm/s and the acceleration will be a half of the normal value.

■ Setting value

NORMAL · HEAVY



* If a heavy sheet or wide sheet is cut (plotted) at a high speed, “ERR41 MOTOR B” can arise. In addition, slippage of the sheet can occur.

Setup resetting [SETUP RESET]

This function is used to return settings of all items including tool conditions and distance compensation to the initial settings factory-settings at the time of delivery.

The settings that have been established as initial ones remain in memory even if the power is turned off.

CHAPTER 4

IN CASE OF TROUBLE

This chapter describes items to be checked in the event that abnormal conditions are encountered and remedies to be taken in the event that an error message appears on the LCD.

BEFORE TAKING A PHENOMENON AS A TROUBLE

Take appropriate remedies referring to the phenomena described below.

■ **The device cannot detect a sheet. [** NO SHEET **]**

Cause 1 : A transparent sheet or a sheet of which wrong side is black is used.

Remedy 1 : Set the sheet sensor function to OFF.

■ **The device performs cutting to produce broken lines.**

Cause 1 : Screw in the tool holder has loosened.

Remedy 1 : Tighten the screw.

Cause 2 : The blade of the cutter protrudes excessively.

Remedy 2 : Adjust the protruding amount of the blade adequately.

Cause 3 : Is the tool condition set to [HALF]

Remedy 3 : Set the tool condition to [CUT].

Cause 4 : The blade is chipped or has worn out.

Remedy 4 : Replace the blade with a new one.

■ **A communication error arises in prior to receiving data.**

Cause 1 : The power to the device and that to the host computer have been turned on in wrong order.

Remedy 1 : Turn on the power to the host computer first. Then, turn on the power to the device.

■ **The device does not operate even if the host computer sends data to the device.**

Cause 1 : The plotter name specified on the host computer is wrong.

Remedy 1 : Check up the plotter name specified on the host computer.

Cause 2 : The interface cable is not securely connected to the device and/or the host computer.

Remedy 2 : Securely connect the interface cable.

■ **An error arises on the device when the host computer sends data to the device.**

Cause 1 : Communication conditions have not been properly established.

Remedy 1 : Check up the communication conditions.

Cause 2 : A wrong operation has been executed.

Remedy 2 : Execute the correct operation.

■ **The device fails to cut the paper.**

Cause 1 : Cutting conditions have not been established.

Remedy 1 : Select the cutting condition (HALF).

■ **Slippage of sheet arises in cutting.**

- Cause 1** : The pinch rollers and grid rollers fail to securely retain the sheet in position.
Remedy 1 : Check the position of the pinch rollers and grid roller and adjust them so that they securely retain the sheet in position.
- Cause 2** : The clamp pressure (high or low mode) has not been properly selected.
Remedy 2 : Select the adequate clamp pressure.
- Cause 3** : The roller sheet is not wound with properly tensed and is slack. The sheet meanders or becomes aslant at the time of the sheet feed.
Remedy 3 : Remove a slack of the roll sheet and straighten the right and left end faces of the roll when loading the roll sheet on the device. Then, execute the sheet feed.
- Cause 4** : The sheet has bent to come off the mount to have air bubbles between them.
Remedy 4-1 : If the sheet is to be cut longer, take care not to allow the sheet to bend while it is fed or cut to avoid an extra load to the sheet.
Remedy 4-2 : If the sheet is to be cut longer, be sure to secure a sufficient space for working in the direction to which the sheet is fed. (Front: 1.5 m or more Back: 1.5 m or more)
- Cause 5** : The sheet comes in contact with the floor surface. (The front end of the sheet is cut aslant.)
Remedy 5-1 : Decrease the cutting speed (SPEED) to reduce the load to the sheet when it contacts the floor surface.
Remedy 5-2 : If you use CG-60EX, use the optional stand or any stand that is equivalent to the optional one.
- Cause 6** : Side margins of the sheet at the location of the pinch rollers is inadequate.
Remedy 6 : Be sure to secure a side margin of 20 mm or more on each side of the sheet at the location of the pinch rollers.

■ **The device drags the tool during running.**

- Cause 1** : The sheet is warped.
Remedy 1 : Load the sheet on the device taking care not to warp it.
- Cause 2** : The lifting/lowering of the tool is faulty.
Remedy 2 : Turn the power off and lift/lower the tool holder by hand.
If the tool holder does not go up but remains in the lower position, call your distributor on the phone for maintenance.

TROUBLE FOR WHICH ERROR MESSAGES ARE GIVEN ON THE LCD



If something is wrong with the device, a corresponding error message is given on the LCD. Take an appropriate corrective measure according to the remedies given in the table below.

Error message	Cause	Action
ERR02 MAIN RAM	Trouble has occurred in the control RAM.	Please call your dealer or our company's sales office for service.
ERR04 EEPROM	Trouble has occurred in the system ROM.	
ERR06 BUFFER	Trouble has occurred in the receiver buffer.	
ERR08 POWER	Trouble related to the motor has occurred.	
ERR10 COMMAND	Code other than command data have been received.	Check up the command data sent from the host computer.
ERR11 PARAMETER	A parameter outside the numerical limits has been received.	Check up the parameter.
ERR12 DEVICE	The device received an improper device control command.	Check up the device control command.
ERR13 PM OVER	Data on polygon has overflowed the polygon buffer.	Divide the data on polygon.
ERR15 AUTO FEED	The device has failed to feed the sheet by the length specified with ZX command. During division cut, the device has failed to feed the sheet, according to the second data, by the length specified by the first data.	After the receipt of data sent from the host computer, replace the sheet with a longer-dimension one and execute the plural sheets cutting. Load a longer sheet on the device and re-set the device in the remote mode.
ERR20 I/O	Communication conditions are wrong.	Establish the same communication conditions with those established on the host computer.
ERR27 BUFFERover	The interface is faulty.	Establish the same communication conditions with those established on the host computer or check up the interface cable.

Error message	Cause	Action
ERR30 OPERATION	An inappropriate operation was performed on the control panel.	Perform the correct operation.
ERR31 NO DATA	The device has executed the plural sheets cutting to find that there is no data in the receiver buffer.	Refer to the explanation of the plural sheets cutting function. (See page 2.12)
ERR32 DATAtooBIG	The amount of received data is too large for the device to perform the plural sheets cutting.	Refer to the explanation of the plural sheets cutting function. (See page 3.13)
ERR33 SHEET SIZE	The sheet is too short in terms of the feeding direction.	Use a longer sheet.
ERR34 DAT REMAIN	The device has executed an improper operation while it is put on hold.	Press the  key to cut the remaining data or clear it. (See page 3.10.)
ERR36 MARKdetect	The device has failed to detect a registration mark.	<ul style="list-style-type: none"> • Check up the procedure you have taken to detect the mark. If you have followed the correct procedure, contact your distributor. • A mark that is not black is printed against white background. • Check whether or not the sheet is curling up.
ERR40 MOTOR A	The sheet feeding motor has been applied with an extra load.	Turn off the power to the device once. Then, re-turn it on. If the same error message re-appears on the LCD, contact your distributor.
ERR41 MOTOR B	The carriage driving motor has been applied with an extra load.	
ERR42 A CURRENT	An overcurrent error in the motor in the lengthwise direction of the sheet has been detected.	
ERR43 B CURRENT	An overcurrent error in the motor in the widthwise direction of the sheet has been detected.	
ERR50 ORIGIN	The device has failed to detect the sheet size.	

Displays under the remote mode

The messages given below appear under the remote mode. They do not indicate errors but require an appropriate action.

Message	Cause	Action
CUT1 * REMOTE *	The device is in the remote mode.	A press on the  key will cause the device to enter the local mode.
CUT1 * 128KB *	This indicates the amount of data received.	When starting cutting, the amount of data will decrease in increments of 1 KB.
** OFFSCALE **	The data on cutting exceeds the effective cutting area.	Use a larger sheet, decrease the amount of data or execute the divided cutting function.
** NO SHEET **	You have turned the sheet setting dial without loading a sheet on the device. The device stops after cutting to the end of sheet.	Place a sheet on the device and turn the sheet setting dial.
** VIEW **	The device has received the not-ready-mode signal (NR;) from the host computer to enter the local mode.	Execute required operations such as the sheet detection or the establishment of an origin. Then, press the  key to make the device to enter the remote mode.
** DIGITIZE **	The device has received the digitization command (DP;) from the host computer to enter the digitization mode.	Move the pen to a desired location, where necessary, and press the  key. To reset the digitization mode, execute the data clear using the key.
* 1/10 COPY *	The device is engaged in the plural sheets cutting. The number indicates the “1st sheet is being cut/ Established number of sheets to be cut.”	Upon completion of the plural sheets cutting, the device will automatically enter the remote mode.
** END COPY **	The device terminates copying when one copy is finished since the data received contains the origin updating command (ZT;, !PG;).	The plural sheets cutting is disabled.
** PAPER CUT **	The device is executing the paper cutting.	Not in particular.

Message	Cause	Action
* DIVISION * 5s	The device has finished the cutting of data that exceeds the sheet width using the division cut and is now waiting for the receipt of next data.	If the device does not receive any data from the host computer within ten seconds, it will recognize the data has ended. Then, the device will perform the frame cutting and mark cutting and enter the local mode.
** DIVISION **	You have made the device to enter the remote mode during the division cut without establishing an origin or replacing the sheet.	Establish an origin or replace the sheet. Then, set the device in the remote mode.
* END DIVISION *	<p>This message appears in the following cases.</p> <ul style="list-style-type: none"> • In the case where the device has received data that contains the origin updating command (ZT;, !PG;) • In the case where the sheet width is 1 cm or less • In the case where the sample cutting data exceeds the sheet width • In the case where the two-point axis alignment is set to ON 	Division cut is disabled.
RS1 CSO DRO ER1	The display change-over for the remote mode has been set to [RS-232C]. (See page 3.25.)	Change over the display, where necessary.

APPENDIX

The appendix describes the replacement of blades, output samples and specifications of the main unit of the device.

CUTTER BLADE



- * The cutter blade is sharp. Keep your fingers away from the blade.
- * Never swing the cutter holder to avoid danger. Blade can jut out from the cutter holder, if swung.

Replacing the cutter blade

If the cutter blade is chipped or blunt, replace it with a new one.

New blades (low-pressure blade set for PVC sheet: Model SPB-0030) are available from your distributor MIMAKI sales office.

■ Replacing the blade of the cutter supplied with the unit as an accessory

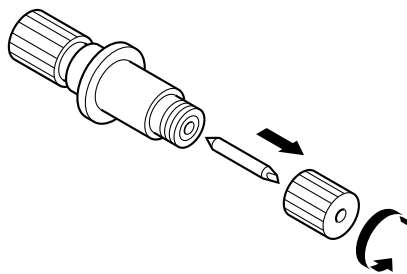

■ Replacing the blade of any cutter other than that supplied with the unit

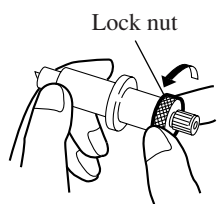

1) Loosen the locknut.

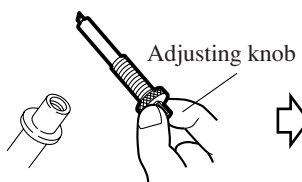

2) Turning the adjusting knob, draw out the cutter from the holder.

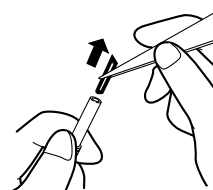

3) Replace the blade with a new one using tweezers or the like.

Adjusting the cutter blade

Adjustment of the blade of any cutter other than that supplied with the unit is described below.

After the completion of adjustment, be sure to set cutting conditions and perform test cutting to check the blade for sharpness.

Refer to page 2.11 for how to adjust the cutter blade supplied with the unit.

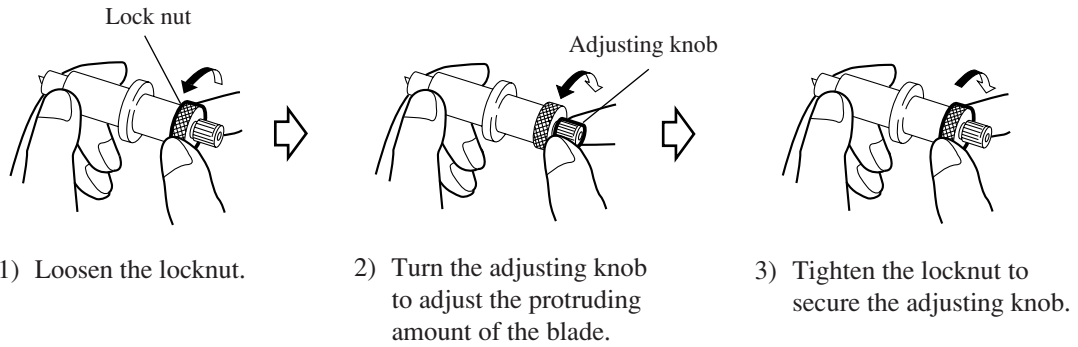

$$\text{Protruding amount of the blade} = \frac{(\text{Film thickness} + \text{Base paper thickness})}{2}$$

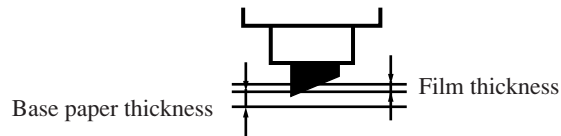

- The blade adjuster (model: OPT-S1005) will facilitate the adjustment of the protruding amount of the blade.

SAMPLE OF OUTPUT

Dump list

■ 8 bit parallel interface

```
INTERFACE: 8BIT PARALLEL (13H 1.00)
AUTO      , NORMAL
IN: ZBO; SCO, 45960, 0, 32440; 000APU|LTCSSSSRO 5, 1, 3ES0
.5DR0, 1.0243LO2PA000APU|O, OPD45960, 0, 45960, 32440, 0
.32440, 0, 000APU|800, 1200PD15200, 1200, 15200, 15600,
800, 15600, 800, 1200000APU|800, 16840PD15200, 16840, 15
200, 31240, 800, 31240, 800, 16840000APU|15600, 1200PD30
000, 1200, 30000, 15600, 15600, 15600, 15600, 1200000APU
15600, 16840PD30000, 16840, 30000, 31240, 15600, 3124
0, 15600, 16840000APU|30400, 1200PD44800, 1200, 44800, 1
5600, 30400, 15600, 30400, 1200000APU|30400, 16840PD448
00, 16800, 44800, 31240, 30400, 31240, 30400, 16840000AP
U|1320, 6800LBCROSS03000APU|3580, 4, 4800000APD3241, 2, 513
9, 6, 3580, 4, 5478, 8, 3920, 0, 5139, 6, 4259, 6, 5478, 8, 00
QA4598, 8, 5139, 6, 4259, 8, 4800, 0, 4598, 8, 4460, 4, 4259
, 6, 4121, 2, 000A3920, 0, 4460, 4, 3580, 4, 4121, 2, 3241, 2,
4460, 4, 3580, 4, 4800, 000APU|3200, 11760000APD3200, 12240, 0
, 3680, 12240, 3680, 12720, 4160, 12720, 4160, 12240, 00
QA4640, 12240, 4640, 11760, 4160, 11760, 4160, 11280, 36
80, 11280, 000A3680, 11760, 3200, 11760000APU|5660, 4, 4800
000APD5321, 2, 5139, 6, 5660, 4, 5478, 8, 6000, 5139, 6, 6678, 8, 00
9, 6, 5478, 8, 000A6678, 8, 5139, 6, 6339, 6, 4800, 8, 6678, 8, 00
, 4460, 4, 6339, 6, 4121, 2, 000A6000, 4460, 4, 5660, 4, 4121,
2, 5321, 2, 4460, 4, 5660, 4, 4800000APU|5280, 11760PD5280
0, 12240, 5760, 12240, 000A5760, 12720, 6240, 12720, 6240, 0
```

■ RS-232C interface

```
INTERFACE: RS-232C (13H 1.00)
9600, 8, NON , 1 , HARD , AUTO
IN: ZBO; SCO, 45960, 0, 32440; 000APU|LTCSSSSRO 5, 1, 3ES0
.5DR0, 1.0243LO2PA000APU|O, OPD45960, 0, 45960, 32440, 0
.32440, 0, 000APU|800, 1200PD15200, 1200, 15200, 15600,
800, 15600, 800, 1200000APU|800, 16840PD15200, 16840, 15
200, 31240, 800, 31240, 800, 16840000APU|15600, 1200PD30
000, 1200, 30000, 15600, 15600, 15600, 15600, 1200000APU
15600, 16840PD30000, 16840, 30000, 31240, 15600, 3124
0, 15600, 16840000APU|30400, 1200PD44800, 1200, 44800, 1
5600, 30400, 15600, 30400, 1200000APU|30400, 16840PD448
00, 16800, 44800, 31240, 30400, 31240, 30400, 16840000AP
U|1320, 6800LBCROSS03000APU|3580, 4, 4800000APD3241, 2, 513
9, 6, 3580, 4, 5478, 8, 3920, 0, 5139, 6, 4259, 6, 5478, 8, 00
QA4598, 8, 5139, 6, 4259, 8, 4800, 0, 4598, 8, 4460, 4, 4259
, 6, 4121, 2, 000A3920, 0, 4460, 4, 3580, 4, 4121, 2, 3241, 2,
4460, 4, 3580, 4, 4800, 000APU|3200, 11760000APD3200, 12240, 0
, 3680, 12240, 3680, 12720, 4160, 12720, 4160, 12240, 00
QA4640, 12240, 4640, 11760, 4160, 11760, 4160, 11280, 36
80, 11280, 000A3680, 11760, 3200, 11760000APU|5660, 4, 4800
000APD5321, 2, 5139, 6, 5660, 4, 5478, 8, 6000, 5139, 6, 6678, 8, 00
9, 6, 5478, 8, 000A6678, 8, 5139, 6, 6339, 6, 4800, 8, 6678, 8, 00
, 4460, 4, 6339, 6, 4121, 2, 000A6000, 4460, 4, 5660, 4, 4121,
2, 5321, 2, 4460, 4, 5660, 4, 4800000APU|5280, 11760PD5280
0, 12240, 5760, 12240, 000A5760, 12720, 6240, 12720, 6240, 0
```

List

LIST (13H 1.00)

(1) PEN PARAMETER

CUT1 20 050 0.30
CUT2 20 080 0.30
CUT3 05 150 0.30
PEN 40 060
PIN 40 080 002P
HALF 20 050 0.30

(2) INTERFACE PARAMETER

MGL-IIc : 9600, 8, NON , 1 , HARD , 0.025mm, NORMAL

(3) FUNCTION PARAMETER

DIST.COMP. = No.1
No.1 = 1.00000 1.00000
No.2 = 1.00000 1.00000
No.3 = 1.00000 1.00000
DISPLAY = English
CUT MODE = NORMAL
ORGN SELECT = CENTER
ROTATION = OFF
DIVISIONcut = OFF ON ON
HALF CUT = OFF ON 0g 0.5mm 10mm
POUNCING = OFF
PRIORITY = PANEL
REMOTE DISP = NORMAL
SHEETsensor = ON
UP SPEED = AUTO
JOG STEP = 1.0mm
MARK DETECT = OFF ON ON
MM/INCH = MM
AUTO FEED = ON
DUMMY CUT = ON

(4) ADJUST PARAMETER

20	39	ZI (CG13H)
10	71	SP (12345611)
0	101	SW (00000100)
0	0	(English)
0	0	
1	0	
7	0	
22	0	
1	0	
19	1	
2	10	
30	300	
0	0	
15	0	
22	2	
27	0	

SPECIFICATIONS OF THE MAIN UNIT

Item	CG-60EX		CG-100EX		CG-130EX	
	mm	inch	mm	inch	mm	inch
Acceptable sheet width	100~624	24	110 ~ 711	24	110 ~ 711	24
			755 ~ 912	30	755 ~ 1070	36, 36, 42
			871 ~ 1028	36, 42	1167 ~ 1324	48, 50, 52
Effective cutting area (note 1)	600 mm x 51 m		1005 mm x 51 m		1300 mm x 51 m	
Maximum cutting speed (note 2)	80 cm/s					
Speed setting (cutting/plotting) (note 2)	1 to 10 cm/s (in 1 cm/s steps), 10 to 40 cm/s (in 5 cm/s steps) 40 to 80 cm/s (in 10 cm/s steps)					
Mechanical resolution	5 μm (excluding expansion/contraction due to film temperatures)					
Program steps	25 μm, 10 μm					
Repeatability	±0.2 mm (excluding expansion/contraction due to film temperatures)					
Guaranteed range of accuracy (repeatability) (note 5)	600 mm x 10 m (depending on the specified film and cutting conditions)		1005 mm x 10 m (depending on the specified film and cutting conditions)		1300 mm x 10 m (depending on the specified film and cutting conditions)	
Maximum pressure	300 g					
Pressure setting	Cutter	10 ~ 20 g (2 g step), 20 ~ 100 g (5 g step), 100 ~ 300 g (10 g step)				
	Pin	10 ~ 20 g (2 g step), 20 ~ 100 g (5 g step), 100 ~ 300 g (10 g step)				
	Pen	10 ~ 20 g (2 g step), 20 ~ 100 g (5 g step), 100 ~ 150 g (10 g step)				
Acceptable films	PVC sheets (0.2 mm thick or less), fluorescent sheets, reflective sheets (note 3), laminated sheets (0.2 mm thick or less)					
Acceptable sheet for pouncing	Paper (thickness: 0.06 to 0.13 mm) (note 4)					
Applicable tools	Cutters, water-ink ball-point pens and oil-ink ball-point pens					
Commands	MGL-IIc					
Interface	RS-232C, 8-bit parallel					
Receiver buffer	2 MB standard					
Operating environment	5 to 35°C, 35 to 75 % (Rh) Non-condensing					
Power capacity	220/240 VAC, 170 VA or less					
Outside dimensions	1030 (W) x 438 (D) x 390 (H) provided with a roll stand.		1430 (W) x 610 (D) x 1160 (H)		1730 (WW) x 610 (D) x 1160 (H)	
Weight	26 kg		50 kg (provided with stands)		58 kg (provided with stands)	

- Notes Refer to the next page for the explanation of notes 1 to 5.

(Note 1) : The maximum feeding length is restricted by the software to be used.

(Note 2) : The maximum speed may be restricted by the sheet size.

(Note 3) : Provided that the blade specific to fluorescent sheets and the blade specific to reflective sheets are used.

(Note 4) : Pouncing tool intended specifically to pouncing shall be used.

(Note 5) : To achieve the guaranteed range of accuracy, the following requirements shall be satisfied.

Plotter conditions

- The exclusive stands shall be used (for CG-60EX, the exclusive optional stands or equivalent shall be used).
- Exclusive roll bars and sheet set rings (when a roll sheet is used) shall be used.
- The clamp pressure shall be set to “HIGH.”

Sheet setting conditions

- Side margin of the sheet: 20 mm or more
- Front side condition of the sheet: No leaning or rising shall be observed.
- The sheet shall not bend and shall not come off the base paper to invite air bubbles between them.
- The sheet shall be loaded in the correct matter using the sheet feeding function.
- A roll sheet shall not slacken. (No difference in height shall be observed between the right and left end faces.)

Cutting speed

- 40 cm/s or less (when the cutter supplied with the unit is used)

Data on cutting

- Test pattern for maintenance (continuous 10 strokes in the lengthwise direction)
While the sheet is being cut, the sheet shall not come off the base paper to invite air bubbles between them due to an excessive bend.

Types of sheets

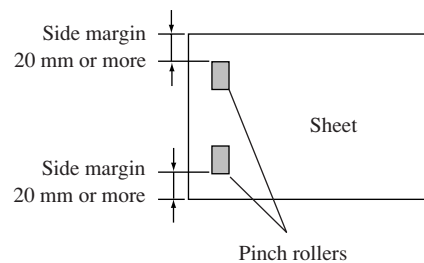

D200370-1.20-14042003

Mimaki

Printed in Japan

D200370

© MIMAKI ENGINEERING CO., LTD.